

EURO / EXCL. VAT 21% / 11.2023

Let op Prijslijsten samengevoegd

Vanaf blz. 90 Lighting

Vanaf blz. Poul 113 Kjaerholm

Vanaf blz. 150 Accessoires

Vanaf blz 194 Skagerak-Collection

FRITZ HANSEN



meinema
interieur | ontwerp | uitvoering



info@meinema.nl



0031 - 20 311 8396

Bekijk hier onze [Fritz Hansen collectie](#)..

CONTENT

03 • GENERAL TERMS AND CONDITIONS

CHAIRS

- 05 • Ant™
- 06 • Series 7™
- 07 • Series 7™
- 08 • Series 7™
- 09 • Children's Chairs / Junior
- 10 • Dot™ / High Dot™
- 11 • Grand Prix™
- 12 • Grand Prix™
- 13 • Grand Prix™
- 14 • Lily™
- 15 • Drop™
- 16 • Little Giraffe™
- 17 • Oxford™
- 18 • Oxford™
- 19 • NO1™
- 20 • NO2™ Recycle
- 21 • NAP™
- 22 • Vico Duo™
- 23 • Vico Duo™
- 24 • China Chair™
- 25 • Carimate™
- 26 • Taburet

LOUNGE

- 27 • Series 3300™
- 28 • Egg™
- 29 • Swan™
- 30 • Oksen™
- 31 • Pot™
- 32 • Lissoni Sofa™
- 33 • Ro™
- 34 • Fri™
- 35 • VIA57™
- 36 • Fred™
- 37 • Let™

SOFAS

- 38 • Series 3300™
- 39 • Swan Sofa™
- 40 • Lissoni Sofa™
- 41 • Lissoni Sofa™
- 42 • Alphabet™ Sofa Series
- 43 • Alphabet™ Sofa Series
- 44 • Favn™
- 45 • Lune™
- 46 • Lune™
- 47 • Ro™ Sofa
- 48 • Plenum™

TABLES

- 49 • Superellipse™
- 50 • Superellipse™
- 51 • Supercircular™
- 52 • Circular
- 53 • Rectangular
- 54 • Egg™ Table
- 55 • FH3605™
- 56 • AJ Trolley™
- 57 • Stub™
- 58 • Essay™
- 59 • Essay™
- 60 • Analog™
- 61 • Join™
- 62 • Pluralis™
- 63 • Pluralis™
- 64 • Pluralis™
- 65 • Little Friend™
- 66 • Planner™ Table Series

SHELVING

- 67 • Planner™ Shelving

OTHER

- 68 • Coat Tree™ / Coat Tree™ Wall

SPARE PARTS

- 69 • Spare Parts
- 70 • Spare Parts

SURFACE SELECTION

- 71 • Surface Selection

GENERAL TERMS AND CONDITIONS

CURRENCY & EFFECTIVE DATE

This price list is valid from 1 November 2023 and cancels all prior price lists.

Reservation is made for any errors and omissions. Furthermore, below general terms and conditions shall apply to all contracts under which Fritz Hansen A/S (Fritz Hansen) is the supplier/sub-supplier.

ORDERING

Orders must be placed through Fritz Hansen's web-based order system called the Partner Portal (www.fritzhanzen.com - professional). Orders are not binding until the customer has received a written order confirmation from Fritz Hansen.

Price lists state the recommended retail price (RRP) or prices excl. VAT exclusive of freight and fees. All prices can be changed without notice. Changes to the collection such as discontinued products and/or items out of stock can occur even when stated differently in the price list. Updated information will be available on the partner portal only.

ORDER CANCELLATION

Orders can be cancelled in accordance with the below rules:

	ORDERS CANCELLED 0-3 DAYS AFTER ORDER CONFIRMATION HAS BEEN SENT	ORDERS CANCELLED 3-14 DAYS AFTER ORDER CONFIRMATION HAS BEEN SENT
STANDARD PRODUCTS	FEE: NONE	FEE: 5% OF NET PRICE EXCL. VAT.
SPECIALS OR MODIFIED PRODUCTS	FEE: FULL PRICE	

Change and cancellation of order after 14 days from receipt of the order confirmation is not possible.

DELIVERY

The following freight rates apply:

RATE	PER ORDER
EU+UK+NO+CH+US*	DKK 200 / € 55 / £ 50 / SEK 600 / NOK 550 / USD 55 EXCL. VAT.
REST OF THE WORLD	TO BE PICKED UP AT FRITZ HANSEN WAREHOUSES

For markets EU+UK+NO+CH+US free freight offered according to the following rates: Free shipping from DKK 3.000 / € 400 / £ 350 / SEK 4.500 / NOK 4.000 / USD 500 total order value excl. VAT.

* For deliveries to outer areas such as islands in Portugal and Spain as well as Svalbard in Norway and others, a surcharge of DKK 420 / € 56 / £ 42 / NOK 580 per parcel will apply.

Standard delivery terms:

- Denmark: DDP delivery address (INCO-Terms 2020)
- Countries within the EU: DDP delivery address (INCO-Terms 2020)
- European countries outside the EU: DAP delivery address (INCO-Terms 2020)
- USA & Canada: DDP delivery address (INCO-Terms 2020)
- Japan: DDP delivery address (INCO-Terms 2020)
- South Korea: DAT Seoul Airport (INCO-Terms 2020)
- Middle East, Asia, South and Central America, Australia: FCA Fritz Hansen warehouses in Denmark and Poland (INCO-Terms 2020)

For FCA: The goods must be picked up at the Fritz Hansen warehouses no later than 30 calendar days after the confirmed shipping date of the consolidated order. Address(es) for pickup will be specified on the commercial invoice. If the goods are not picked up, Fritz Hansen will charge the customer DKK 24 / € 3 / USD 4 per day per pallet.

If the partner so desires, Fritz Hansen can deliver at the end user's address against an additional fee.

CLAIMS

The physical product must be inspected upon delivery. Damage incurred in transit as well as any defects and deficiencies on the product incurred as a result of transportation must be recorded on the POD upon delivery. Fritz Hansen must be notified in writing of any claims about product defects and deficiencies within 48 hours of delivery. If the claims are made in due time and with the acceptance of Fritz Hansen, the customer is entitled to demand a replacement delivery or to have the defect remedied. The customer cannot demand a reduction or a compensation. Claims/replacements can only be made to the customer's address if delivery has not been made directly to the end user.

TERMS OF PAYMENT

Terms of payment are 30 days net cash from invoice date. Invoices are issued and dated when the goods are dispatched. In case of late payment, interest will be charged at a rate of 1.5 % for every month or part thereof as from the due date. Interest invoices are payable net cash within eight days. Fritz Hansen can decide that the customer shall pay in advance, if the customer's balance is or has previously been due, or if the order amount exceeds the credit limit approved by Fritz Hansen.

OBSERVATION OF TITLE

Title to the goods shall not pass to the customer until Fritz Hansen (or any third party to whom Fritz Hansen has assigned its rights to the purchase price) has received the full purchase price and been reimbursed any expenses incurred.

WARRANTY

Fritz Hansen provides a standard five-year warranty on standard products within the collections Furniture and Skagerak Collection (Indoor & Outdoor) against defects in materials and workmanship. For the Arne Jacobsen shell chairs (Ant™, Grand Prix™, Lily™, Series 7™), the standard warranty is 10 years. Within the Furniture collection, an extended warranty of up to 10 years is provided on selected products, provided they have been registered online on www.fritzhanzen.com/my-fh (see table on the next page for details).

For the Poul Kjærholm collection, the standard warranty is 20 years except for PK0 A™ and PK60™, which is 10 years, and the PK15™, which is 5 years. Wicker and French Cane have a warranty of 2 years.

For the Lighting, Accessories and Skagerak Collection Accessories the standard warranty is 2 years. Specific for the Lighting category: Transformers, ballasts, light sources, and other electronic devices are subject to the warranty terms of the manufacturer in question. Fritz Hansen does not cover costs related to installation and dismantling, replacement of ballasts/transformers and other similar costs related to electricians and the like.

The warranty on all collections does not extend to ordinary tear, wear or damage to upholstery. On any material, textile, or leather which is not listed in our price lists configured on a specific product, the standard warranty is 2 years. The warranty is void upon subsequent changes to the product.

Additional warranty conditions can be found on www.fritzhanzen.com.

LIMITATION OF LIABILITY

Fritz Hansen will assume no liability for any loss as a result of delays, defects or any other breach of contract, unless such loss was caused by gross negligence on the part of Fritz Hansen. Fritz Hansen will assume no liability for any indirect loss, including loss of profits, operating loss, goodwill, loss of customers, running costs or any other consequential economic loss.

CHOICE OF LAW AND JURISDICTION

Disputes between Fritz Hansen and its customers shall be subject to Danish law, except for the international civil law rules of Danish law, and shall be settled by Fritz Hansen's home court.

MEASUREMENTS

The stated measurements act only as a guideline. The measurements can vary, and size difference on a product can occur.

FORCE MAJURE

Fritz Hansen is without liability for non-performance of Fritz Hansen's obligations in respect to any orders received, if such non-performance is due to circumstances out of Fritz Hansen's reasonable control, which prevent the fulfilment of the purchase agreement or makes the fulfilment unreasonably burdensome. As examples of such circumstances the following can be mentioned: Industrial dispute and other circumstances which are beyond the control of the parties, such as fire, war, mobilization or calling in for military service of similar extent, requisition, seizure, exchange controls, riots or disturbances, shortage of means of transportation, ordinary scarcity of goods, restrictions of motive power and defects in or late performance from sub-suppliers due to any of the aforementioned circumstances.

The above circumstances only lead to exemption from liability if their influence on the fulfilment of the purchase agreement could not be anticipated at the conclusion of the agreement. Fritz Hansen must without undue delay notify the customer in writing if any such circumstances, occurrence and cessation, if Fritz Hansen wishes to invoke any grounds of exemption from liability.

Regardless of what follows from these general conditions of sales and delivery, any party is entitled to terminate the purchase agreement by notifying the other party in writing, if the fulfilment of the agreement is prevented for more than 6 months due to one of the above circumstances.

Unless mandatory rules preclude this, Fritz Hansen is in no case liable to the customer for operating losses, lost earnings, or other financial consequential damages under these general conditions for sale and delivery.

PRIVACY POLICY

At Fritz Hansen, confidentiality and data protection is a high priority. Guidelines for processing of personal data and description of the customer's and end users' rights according to applicable data protection law is governed by Fritz Hansen's privacy policy available on Fritz Hansen's website.

WARRANTY OVERVIEW

Price list collections	Furniture Collection						Poul Kjærholm Collection				Skagerak Collection		Lighting Collection	Accessories Collection					
	Textile Cushions	Leather (1)	Leather (2)	Bases (3)	Bases (4)	Movable parts (5)	Anrt™ Grand Prix™, Lily™, Series 7™	Shells, Tabletops	Tabletops (6)	China Chair™	French Cane, Wicker	PK15™	PKO A™ & PK60™	Poul Kjærholm Collection	Outdoor	Indoor	Lighting	Accessories	Skagerak Collection
2 years										x							x	x	x
5 years	x	x		x		x					x			x	x				
10 years			x*			x*		x*				x**							
20 years									x**				x**						

1. Leather: Soft and Essential
2. Leather: Aura, Rustik, Natural, Grace and Embrace
3. Bases: Lacquered and Wooden (chairs), Powder coated (chairs and tables)
4. Bases: Aluminium, Chrome and Wooden (tables)
5. Movable parts: Automatic return, Tilt, Height-adjustable, Swivel, Castors and Extension mechanism
6. Tabletops: Lacquer under tabletop, Lacquer on edges and Surface on tabletop

* Additional with registration on www.fritzhansen.com/my-fh

** Standard without registration



ANT™
ARNE JACOBSEN 1952

11.2023

The Ant™ comes in clear lacquered, coloured ash or lacquered veneer. All chairs are made of pressure moulded veneer and are stackable. The shell is also available in front upholstered versions in a wide range of textiles and leather types. The base comes with 3 or 4 legs made of chromed or powder coated tubular steel.

MODEL	DESCRIPTION	COLOURED ASH VENEER	LACQUERED VENEER	CLEAR LACQUERED VENEER
3100	Chair, 3 legs, stackable (max 8 pcs), seat height 44 cm or 46 cm, chromed or powder coated tubular steel base	280	296	428
3101	Chair, 4 legs, stackable (max 12 pcs), seat height 44 cm or 46 cm, chromed or powder coated tubular steel base	280	296	428

COLOURED ASH AND LACQUERED VENEER - SEE THE SURFACE SELECTION
PALE ROSE, WILD ROSE, VENETIAN RED, PARADISE ORANGE, BURNT YELLOW, TRUE YELLOW, LIGHT BEIGE, DEEP CLAY, OLIVE GREEN, LAVENDER BLUE, DUSK BLUE, MIDNIGHT BLUE, EVERGREEN, BLACK, NINE GREY, WHITE

CLEAR LACQUERED VENEER - SEE THE SURFACE SELECTION
MAPLE, BEECH, ASH, CHERRY, OREGON PINE, ELM, OAK, WALNUT, OAK - DARK STAINED, OAK - FULL DARK STAINED

BASE COLOURS
SILVER GREY, WARM GRAPHITE, BROWN BRONZE, BLACK, WHITE (ONLY WITH WHITE SHELL), NINE GREY, CHROME

FRONT UPHOLSTERED - COLOURED ASH VENEER

MODEL	DESCRIPTION	CHRISTIANSHAVN	CATEGORY 1	CATEGORY 2	CATEGORY 3	CATEGORY 4	CATEGORY 5
3100	Chair, 3 legs, seat height 44 cm or 46 cm, chromed or powder coated tubular steel base	428	478	511	693	825	1.156
3101	Chair, 4 legs, seat height 44 cm or 46 cm, chromed or powder coated tubular steel base	428	478	511	693	825	1.156

FRONT UPHOLSTERED - LACQUERED VENEER

MODEL	DESCRIPTION	CHRISTIANSHAVN	CATEGORY 1	CATEGORY 2	CATEGORY 3	CATEGORY 4	CATEGORY 5
3100	Chair, 3 legs, seat height 44 cm or 46 cm, chromed or powder coated tubular steel base	445	495	528	709	866	1.156
3101	Chair, 4 legs, seat height 44 cm or 46 cm, chromed or powder coated tubular steel base	445	495	528	709	866	1.156

FRONT UPHOLSTERED - CLEAR LACQUERED VENEER

MODEL	DESCRIPTION	CHRISTIANSHAVN	CATEGORY 1	CATEGORY 2	CATEGORY 3	CATEGORY 4	CATEGORY 5
3100	Chair, 3 legs, seat height 44 cm or 46 cm, chromed or powder coated tubular steel base	577	619	652	825	990	1.280
3101	Chair, 4 legs, seat height 44 cm or 46 cm, chromed or powder coated tubular steel base	577	619	652	825	990	1.280

CATEGORY 1: CANVAS, CAPTURE, DIABLO, FAME, REMIX, TONUS
CATEGORY 2: DIVINA, DIVINA MELANGE, DIVINA MD, FIORD, HALLINGDAL, RE-WOOL, STEELCUT, STEELCUT TRIO, SUNNIVA, VANIR, VIDAR
CATEGORY 3: COMFORT, ESSENTIAL
CATEGORY 4: Soft
CATEGORY 5: Grace, Embrace, Natural
SELECTED TEXTILE COLOURS - SEE THE SURFACE SELECTION
BELFAST (770593, 770660, 771772, 772062, 772143, 772150, 772255, 774232, 774926, 775139)
VANIR (193, 243, 373, 393, 413, 443, 473, 693, 733, 773, 913, 983)

DESCRIPTION	PRICE
Linking device for 3101	65
Felt glides (3 or 4 pcs.)	7
Small transport dolly for 8 chairs (3100) or 12 chairs (3101)	395
Large transport dolly for 40 chairs	759
Chair rack, mounted under a table top	57

3100 3101 SMALL AND LARGE TRANSPORT DOLLY FOR STACKABLE CHAIRS

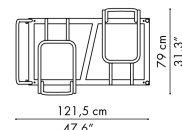
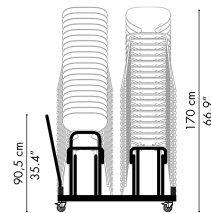
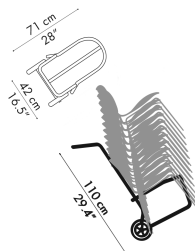
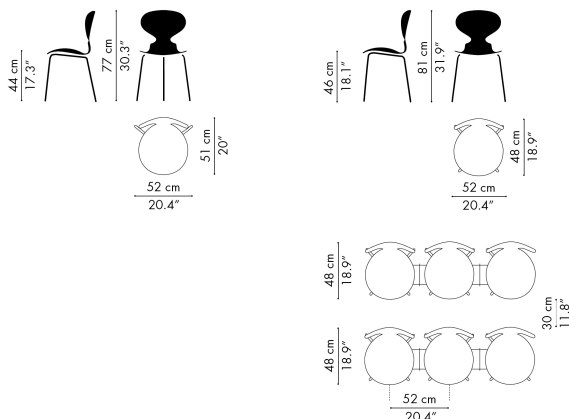



SERIES 7™
ARNE JACOBSEN 1955

11.2023

The Series 7™ chair comes in three different finishes: Clear lacquered, coloured ash or lacquered veneer. All chairs are made of pressure moulded veneer. The shell is also available in front or fully upholstered versions in a wide range of textiles and leather types. Besides a base with four legs made of tubular steel, it also comes with a height-adjustable swivel base and castors, a counter or a bar stool. The bases of the Series 7™ are available with either a chromed or powder coated finish.

MODEL	DESCRIPTION	COLOURED ASH VENEER	LACQUERED VENEER	CLEAR LACQUERED VENEER
3107	Chair, stackable (max 12 pcs.), seat height 43 cm, 46 cm or 48 cm, chromed or powder coated tubular steel base	412	428	495
3207	Armchair, seat height 43 cm or 46 cm, chromed or powder coated tubular steel base	676	759	825
3187	Counter stool, seat height 64 cm, chromed or powder coated tubular steel base	577	594	660
3197	Bar stool, seat height 76 cm, chromed or powder coated tubular steel base	577	594	660
3117	Swivel chair, adjustable seat height 44-56 cm, 5 castors, chromed or powder coated tubular steel base	908	949	990
3217	Swivel armchair, adjustable seat height 44-56 cm, 5 castors, chromed or powder coated tubular steel base	1.156	1.238	1.321

COLOURED ASH AND LACQUERED VENEER - SEE THE SURFACE SELECTION
PALE ROSE, WILD ROSE, VENETIAN RED, PARADISE ORANGE, BURNT YELLOW, TRUE YELLOW, LIGHT BEIGE, DEEP CLAY, OLIVE GREEN, LAVENDER BLUE, DUSK BLUE, MIDNIGHT BLUE, EVERGREEN, BLACK, NINE GREY, WHITE

CLEAR LACQUERED VENEER - SEE THE SURFACE SELECTION
MAPLE, BEECH, ASH, CHERRY, OREGON PINE, ELM, OAK, WALNUT, OAK - DARK STAINED, OAK - FULL DARK STAINED

BASE COLOURS
SILVER GREY, WARM GRAPHITE, BROWN BRONZE, BLACK, WHITE (ONLY WITH WHITE SHELL), NINE GREY, CHROME

FRONT UPHOLSTERED - COLOURED ASH VENEER

MODEL	DESCRIPTION	CHRISTIANSHAVN	CATEGORY 1	CATEGORY 2	CATEGORY 3	CATEGORY 4	CATEGORY 5
3107	Chair, seat height 43 cm, 46 cm or 48 cm, chromed or powder coated tubular steel base	561	610	643	825	990	1.280
3207	Armchair, seat height 43 cm or 46 cm, chromed or powder coated tubular steel base	825	908	908	1.114	1.238	1.528
3187	Counter stool, seat height 64 cm, chromed or powder coated tubular steel base	734	776	817	990	1.156	1.445
3197	Bar stool, seat height 76 cm, chromed or powder coated tubular steel base	734	776	817	990	1.156	1.445
3117	Swivel chair, adjustable seat height 44-56 cm, 5 castors, chromed or powder coated tubular steel base	1.073	1.114	1.156	1.321	1.486	1.817
3217	Swivel armchair, adjustable seat height 44-56 cm, 5 castors, chromed or powder coated tubular steel base	1.321	1.362	1.404	1.569	1.734	2.065

FRONT UPHOLSTERED - LACQUERED VENEER

MODEL	DESCRIPTION	CHRISTIANSHAVN	CATEGORY 1	CATEGORY 2	CATEGORY 3	CATEGORY 4	CATEGORY 5
3107	Chair, seat height 43 cm, 46 cm or 48 cm, chromed or powder coated tubular steel base	577	619	660	825	990	1.280
3207	Armchair, seat height 43 cm or 46 cm, chromed or powder coated tubular steel base	949	990	990	1.197	1.321	1.610
3187	Counter stool, seat height 64 cm, chromed or powder coated tubular steel base	759	792	825	1.032	1.156	1.445
3197	Bar stool, seat height 76 cm, chromed or powder coated tubular steel base	759	792	825	1.032	1.156	1.445
3117	Swivel chair, adjustable seat height 44-56 cm, 5 castors, chromed or powder coated tubular steel base	1.114	1.156	1.197	1.362	1.486	1.817
3217	Swivel armchair, adjustable seat height 44-56 cm, 5 castors, chromed or powder coated tubular steel base	1.404	1.486	1.486	1.734	1.817	2.147

FRONT UPHOLSTERED - CLEAR LACQUERED VENEER

MODEL	DESCRIPTION	CHRISTIANSHAVN	CATEGORY 1	CATEGORY 2	CATEGORY 3	CATEGORY 4	CATEGORY 5
3107	Chair, seat height 43 cm, 46 cm or 48 cm, chromed or powder coated tubular steel base	652	693	726	908	1.073	1.362
3207	Armchair, seat height 43 cm or 46 cm, chromed or powder coated tubular steel base	990	1.073	1.073	1.280	1.404	1.734
3187	Counter stool, seat height 64 cm, chromed or powder coated tubular steel base	825	866	908	1.073	1.238	1.528
3197	Bar stool, seat height 76 cm, chromed or powder coated tubular steel base	825	866	908	1.073	1.238	1.528
3117	Swivel chair, adjustable seat height 44-56 cm, 5 castors, chromed or powder coated tubular steel base	1.156	1.238	1.238	1.445	1.569	1.900
3217	Swivel armchair, adjustable seat height 44-56 cm, 5 castors, chromed or powder coated tubular steel base	1.486	1.528	1.569	1.817	1.900	2.230

CATEGORY 1: BELFAST, CANVAS, CAPTURE, DIABLO, FAME, REMIX, TONUS
CATEGORY 2: DIVINA, DIVINA MELANGE, DIVINA MD, FIORD, HALLINGDAL, RE-WOOL, STEELCUT, STEELCUT TRIO, SUNNIVA, VANIR
CATEGORY 3: COMFORT, ESSENTIAL
CATEGORY 4: SOFT
CATEGORY 5: GRACE, EMBRACE, NATURAL, CHESTNUT

SELECTED TEXTILE COLOURS - SEE THE SURFACE SELECTION
BELFAST (770593, 770660, 771772, 772062, 772143, 772150, 772255, 774232, 774926, 775139)
VANIR (193, 243, 373, 393, 413, 443, 473, 693, 733, 773, 913, 983)



FULLY UPHOLSTERED

MODEL	DESCRIPTION	CHRISTIANSHAVN	CATEGORY 1	CATEGORY 2	CATEGORY 3	CATEGORY 4	CATEGORY 5
3107	Chair, seat height 43 cm, 46 cm or 48 cm, chromed or powder coated tubular steel base	652	676	718	990	1.197	1.652
3207	Armchair, seat height 43 cm or 46 cm, chromed or powder coated tubular steel base	908	949	990	1.238	1.445	1.817
3187	Counter stool, seat height 64 cm, chromed or powder coated tubular steel base	866	908	949	1.197	1.404	1.652
3197	Bar stool, seat height 76 cm, chromed or powder coated tubular steel base	866	908	949	1.197	1.404	1.652
3117	Swivel chair, adjustable seat height 44-56 cm, 5 castors, chromed or powder coated tubular steel base	1.073	1.156	1.197	1.404	1.610	1.900
3217	Swivel armchair, adjustable seat height 44-56 cm, 5 castors, chromed or powder coated tubular steel base	1.404	1.445	1.528	1.734	1.982	2.313

CATEGORY 1: BELFAST, CANVAS, CAPTURE, DIABLO, FAME, REMIX, TONUS

CATEGORY 2: DIVINA, DIVINA MELANGE, DIVINA MD, FIORD, HALLINGDAL, RE-WOOL, STEELCUT, STEELCUT TRIO, SUNNIVA, VANIR

CATEGORY 3: COMFORT, ESSENTIAL

CATEGORY 4: SOFT

CATEGORY 5: GRACE, EMBRACE, RUSTIK, NATURAL

SELECTED TEXTILE COLOURS - SEE THE SURFACE SELECTION

BELFAST (770593, 770660, 771772, 772062, 772143, 772150, 772255, 774232, 774926, 775139)

VANIR (193, 243, 373, 393, 413, 443, 473, 693, 733, 773, 913, 983)

OPTIONS

DESCRIPTION	PRICE
Hard castors for soft floors with or without brake	No surcharge
Soft castor for hard floors with or without brake	No surcharge
Linking device for 3107, short	65
Linking device for 3107 w/writing tablet and 3207, long	65
Writing tablet for 3107, fold-away, white laminated surface, chromed arm	263
Small transport dolly for 12 pcs. 3107 chairs, non-upholstered	395
Large transport dolly for 40 pcs. 3107 chairs, non-upholstered	759
Felt glides (4 pcs.)	7
Chair rack for 3107 chairs, mounted under a table top, for non-upholstered chairs only	57
3107SC Seat cushion, Wild leather, walnut	98
3107SC Seat cushion, Raw leather, black (colli 12 pcs.)	69
3107SC Seat cushion, Intense leather, brown (colli 12 pcs.)	69



3107

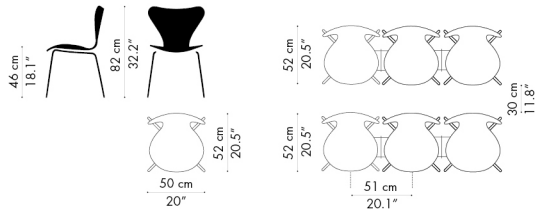

3107 WITH WRITING TABLET

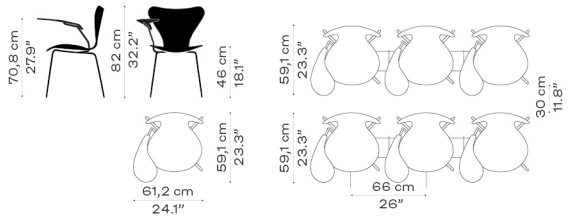

3102

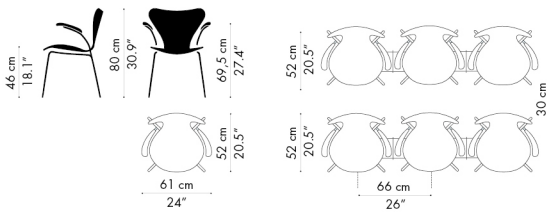

3117

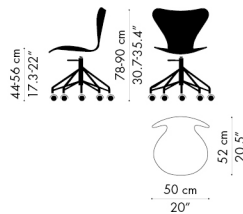

3217

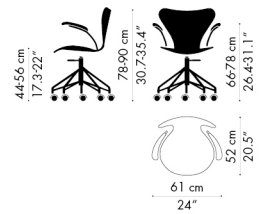

3117

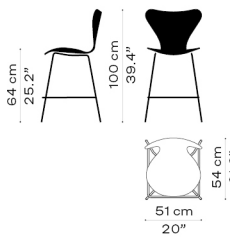

3217

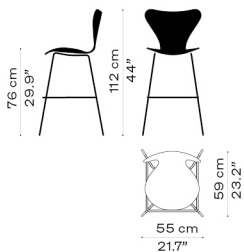

SMALL AND LARGE TRANSPORT DOLLY FOR STACKABLE CHAIRS

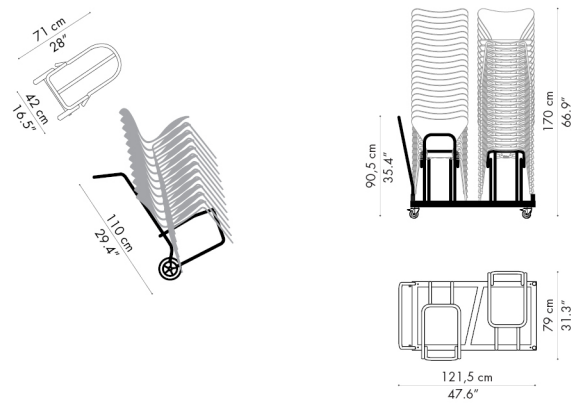



CHILDREN'S CHAIRS / JUNIOR ARNE JACOBSEN 2005/2019

11.2023

The Children's Chairs are available in three variants: Coloured ash veneer (Wild Rose and Midnight Blue) and clear lacquered Oregon Pine. The base comes with 4 legs (stackable) and is made of chromed steel tubes. The Junior chair is available in clear lacquered oak veneer or black coloured ash veneer with a chromed steel base, coloured ash veneer in Evergreen or Burned Yellow with a Brown Bronze base.

CHILDREN'S CHAIRS / JUNIOR

MODEL	DESCRIPTION	PRICE
840227	Children's chair, stackable (max 10 pcs.), seat height 34 cm, Rose (626), powder coated tubular steel base matching the shell - colli 2	263
840228	Children's chair, stackable (max 10 pcs.), seat height 34 cm, Lavender blue (885) powder coated tubular steel base matching the shell - colli 2	263
840229	Children's chair, stackable (max 10 pcs.), seat height 34 cm, Black (195), powder coated tubular steel base matching the shell - colli 2	263
840236	Junior chair, seat height 52 cm, Black, chromed tubular steel base	313
840237	Junior chair, seat height 52 cm, Oak veneer, chromed tubular steel base	313
840238	Junior chair, seat height 52, Burnt Yellow, Brown Bronze powder coated tubular steel base	313
840239	Junior chair, seat height 52, Evergreen, Brown Bronze powder coated tubular steel base	313

ANT™ CHILDREN'S CHAIR

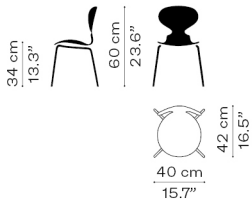

GRAND PRIX™ CHILDREN'S CHAIR

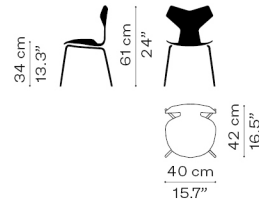

LILY™ CHILDREN'S CHAIR

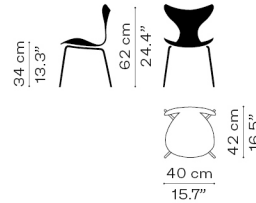

SERIES 7™ CHILDREN'S CHAIR

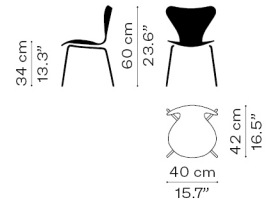

SERIES 7™ JUNIOR

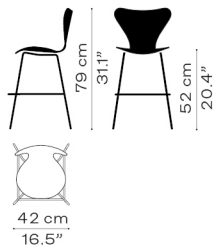



DOT™ / HIGH DOT™
ARNE JACOBSEN 1954

11.2023

The Dot™ and the High Dot™ stools are available in selected leather, textile (only Dot™) and veneer variants: Black coloured ash or clear lacquered walnut. All stools come with four legs, while the High Dot™ Counter also comes with a three-legged base. The bases are made of chromed or powder coated tubular steel.

DOT™, 46CM

MODEL	DESCRIPTION	PRICE
840128	Coloured ash black, chromed tubular steel base	222
840132	Walnut veneer, chromed tubular steel base	222
840105	Intense leather matt black, black powder coated tubular steel base	271
840100	Wild leather Walnut, chromed tubular steel base	271

HIGH DOT™ COUNTER, 65 CM

MODEL	DESCRIPTION	PRICE
840129	3-Legs Coloured ash black, chromed tubular steel base	304
840133	3-Legs Walnut veneer, chromed tubular steel base	304
840106	3-Legs Intense leather Matt black, black powder coated tubular steel base	354
840107	3-Legs Wild leather Walnut, chromed tubular steel base	354
840108	3-Legs buffed leather Lava, chromed tubular steel base	354
840130	4-Legs Coloured ash black, chromed tubular steel base	304
840134	4-Legs Walnut veneer, chromed tubular steel base	304
840136	4-Legs Intense leather Matt black, black powder coated tubular steel base	346
840138	4-Legs Wild leather Walnut, chromed tubular steel base	346

HIGH DOT™ BAR, 76 CM

MODEL	DESCRIPTION	PRICE
840131	4-Legs Coloured ash black, chromed tubular steel base	304
840135	4-Legs Walnut veneer, chromed tubular steel base	304
840137	4-Legs Intense leather Matt black, black powder coated tubular steel base	346
840139	4-Legs Wild leather Walnut, chromed tubular steel base	346

DOT™

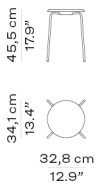

HIGH DOT™ COUNTER

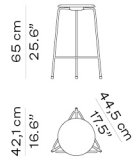

HIGH DOT™ COUNTER

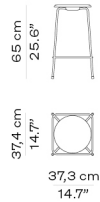

HIGH DOT™ BAR

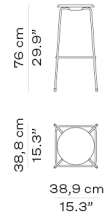



GRAND PRIX™
ARNE JACOBSEN 1957

11.2023

The Grand Prix™ comes in clear lacquered (oak or walnut), coloured ash or lacquered (only 3130) veneer. All chairs are made of pressure moulded veneer. Front upholstery or full upholstery is available in a wide range of textiles and leather types. The base comes with four legs in several variants: Chromed or powder coated tubular steel (stackable max 5 pcs.) and wooden legs (non-stackable). Besides a base with four legs made of tubular steel, it also comes with a height-adjustable swivel base and castors, a counter or a bar stool.

MODEL	DESCRIPTION	COLOURED ASH VENEER	LACQUERED VENEER	CLEAR LACQUERED VENEER
3130	Chair, stackable (max 5 pcs.), seat height 43 cm, 46 cm or 48 cm, chromed or powder coated tubular steel base	412	428	495
4130	Chair, seat height 43 cm or 46 cm, wooden legs	569		594
3138	Counter stool, seat height 64 cm, chromed or powder coated tubular steel base	552	569	635
3139	Bar stool, seat height 76 cm, chromed or powder coated tubular steel base	552	569	635
3131	Swivel chair, adjustable seat height 44-56 cm, 5 castors, chromed or powder coated tubular steel base	866	908	990

COLOURED ASH AND LACQUERED VENEER - SEE THE SURFACE SELECTION
PALE ROSE, WILD ROSE, VENETIAN RED, PARADISE ORANGE, BURNT YELLOW, TRUE YELLOW, LIGHT BEIGE, DEEP CLAY, OLIVE GREEN, LAVENDER BLUE, DUSK BLUE, MIDNIGHT BLUE, EVERGREEN, BLACK, NINE GREY, WHITE

CLEAR LACQUERED VENEER - SEE THE SURFACE SELECTION
OAK, WALNUT

BASE COLOURS
3130, 3131, 3138, 3139: SILVER GREY, WARM GRAPHITE, BROWN BRONZE, BLACK, WHITE (ONLY WITH WHITE SHELL), NINE GREY, CHROME
4130: OAK, WALNUT, BLACK, NINE GREY, WHITE (ONLY WITH WHITE SHELL)

[*OAK/WALNUT VENEER SHELLS ARE ONLY AVAILABLE WITH MATCHING WOODEN BASE]

FRONT UPHOLSTERED - COLOURED ASH VENEER

MODEL	DESCRIPTION	CHRISTIANSHAVN	CATEGORY 1	CATEGORY 2	CATEGORY 3	CATEGORY 4	CATEGORY 5
3130	Chair, stackable (max 5 pcs.), seat height 43 cm, 46 cm or 48 cm, chromed or powder coated tubular steel base	561	610	643	825	990	1.280
4130	Chair, seat height 43 cm or 46 cm, wooden legs	718	767	800	990	1.156	1.404
3138	Counter stool, seat height 64 cm, chromed or powder coated tubular steel base	701	742	776	949	1.073	1.362
3139	Bar stool, seat height 76 cm, chromed or powder coated tubular steel base	701	742	776	949	1.073	1.362
3131	Swivel chair, adjustable seat height 44-56 cm, 5 castors, chromed or powder coated tubular steel base	990	1.073	1.073	1.238	1.404	1.652

FRONT UPHOLSTERED - LACQUERED VENEER

MODEL	DESCRIPTION	CHRISTIANSHAVN	CATEGORY 1	CATEGORY 2	CATEGORY 3	CATEGORY 4	CATEGORY 5
3130	Chair, stackable (max 5 pcs.), seat height 43 cm, 46 cm or 48 cm, chromed or powder coated tubular steel base	577	619	660	825	990	1.280
3138	Counter stool, seat height 64 cm, chromed or powder coated tubular steel base	709	759	792	990	1.114	1.404
3139	Bar stool, seat height 76 cm, chromed or powder coated tubular steel base	709	759	792	990	1.114	1.404
3131	Swivel chair, adjustable seat height 44-56 cm, 5 castors, chromed or powder coated tubular steel base	1.073	1.073	1.114	1.321	1.445	1.734

FRONT UPHOLSTERED - CLEAR LACQUERED VENEER

MODEL	DESCRIPTION	CHRISTIANSHAVN	CATEGORY 1	CATEGORY 2	CATEGORY 3	CATEGORY 4	CATEGORY 5
3130	Chair, stackable (max 5 pcs.), seat height 43 cm, 46 cm or 48 cm, chromed or powder coated tubular steel base	652	693	726	908	1.073	1.362
4130	Chair, seat height 43 cm or 46 cm, wooden legs	742	784	825	1.032	1.156	1.445
3138	Counter stool, seat height 64 cm, chromed or powder coated tubular steel base	784	825	866	1.032	1.156	1.445
3139	Bar stool, seat height 76 cm, chromed or powder coated tubular steel base	784	825	866	1.032	1.156	1.445
3131	Swivel chair, adjustable seat height 44-56 cm, 5 castors, chromed or powder coated tubular steel base	1.114	1.156	1.197	1.362	1.486	1.817

CATEGORY 1: CANVAS, CAPTURE, DIABLO, FAME, REMIX, TONUS
CATEGORY 2: DIVINA, DIVINA MELANGE, DIVINA MD, FIORD, HALLINGDAL, RE-WOOL, STEELCUT, STEELCUT TRIO, SUNNIVA, VANIR
CATEGORY 3: COMFORT, ESSENTIAL
CATEGORY 4: SOFT
CATEGORY 5: GRACE, EMBRACE, NATURAL

SELECTED TEXTILE COLOURS - SEE THE SURFACE SELECTION
VANIR (193, 243, 373, 393, 413, 443, 473, 693, 733, 773, 913, 983)



FULLY UPHOLSTERED

MODEL	DESCRIPTION	CHRISTIANSHAVN	CATEGORY 1	CATEGORY 2	CATEGORY 3	CATEGORY 4	CATEGORY 5
3130	Chair, seat height 43 cm, 46 or 48 cm, chromed or powder coated tubular steel base	652	676	718	990	1.197	1.652
4130	Chair, seat height 43 cm or 46 cm, wooden legs	809	866	908	1.156	1.362	1.817
3138	Counter stool, seat height 64 cm, chromed or powder coated tubular steel base	825	866	908	1.156	1.321	1.569
3139	Bar stool, seat height 76 cm, chromed or powder coated tubular steel base	825	866	908	1.156	1.321	1.569
3131	Swivel chair, adjustable seat height 44-56 cm, 5 castors, chromed or powder coated tubular steel base	1.032	1.073	1.156	1.321	1.569	1.817

CATEGORY 1: CANVAS, CAPTURE, DIABLO, FAME, REMIX, TONUS
 CATEGORY 2: DIVINA, DIVINA MELANGE, DIVINA MD, FIORD, HALLINGDAL, RE-WOOL, STEELCUT, STEELCUT TRIO, SUNNIVA, VANIR
 CATEGORY 3: COMFORT, ESSENTIAL
 CATEGORY 4: SOFT
 CATEGORY 5: GRACE, EMBRACE, RUSTIK, NATURAL

SELECTED TEXTILE COLOURS - SEE THE SURFACE SELECTION
 VANIR (193, 243, 373,393, 413, 443, 473, 693, 733, 773, 913, 983)

OPTIONS

DESCRIPTION	PRICE
Hard castors for soft floors with or without brake	No surcharge
Soft castor for hard floors with or without brake	No surcharge
Linking device for 3130 chairs	65
Small transport dolly for 5 pcs. 3130 chairs, non-upholstered	395
Chair rack for 3130 chairs, mounted under a table top, for non-upholstered chairs only	57
Felt glides (4 pcs.)	7



3130

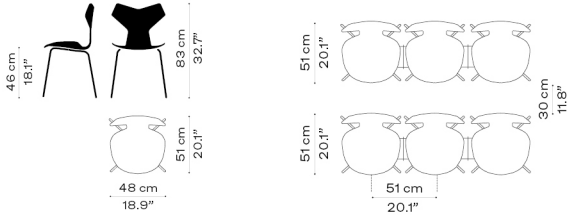

4130

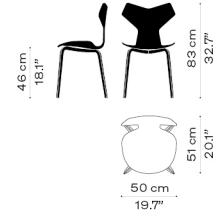

3131

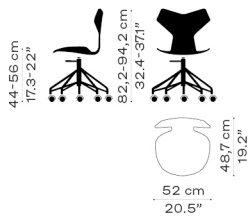

3138

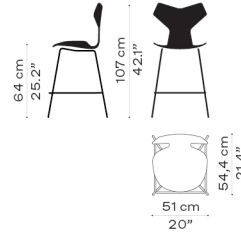

3139

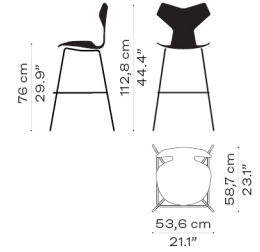

SMALL TRANSPORT DOLLY FOR STACKABLE CHAIRS

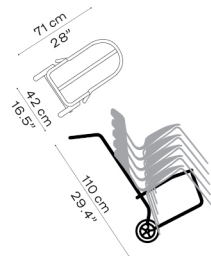



The Lily™ chair comes in two variants; with or without arms, in clear lacquered walnut veneer or fully upholstered in a wide range of textiles and leather types. All chairs are made of pressure moulded veneer. The base comes with four legs made of chromed tubular steel.

MODEL	DESCRIPTION	CLEAR LACQUERED WALNUT
3108	Chair, stackable (max 8 pcs.), seat height 43 cm or 46 cm, chromed tubular steel base	627
3208	Armchair, seat height 43 cm or 46 cm, chromed tubular steel base	1.114

FULLY UPHOLSTERED

MODEL	DESCRIPTION	CHRISTIANSHAVN	CATEGORY 1	CATEGORY 2	CATEGORY 3	CATEGORY 4	CATEGORY 5
3108	Chair, stackable (max 8 pcs.), seat height 43 cm or 46 cm, chromed tubular steel base	1.073	1.114	1.114	1.569	1.900	2.726
3208	Armchair, seat height 43 cm or 46 cm, chromed tubular steel base	2.230	2.395	2.395	2.643	3.057	3.883

CATEGORY 1: CANVAS, CAPTURE, DIABLO, FAME, REMIX, TONUS
 CATEGORY 2: DIVINA, DIVINA MELANGE, DIVINA MD, FIORD, HALLINGDAL, RE-WOOL, STEELCUT, STEELCUT TRIO, SUNNIVA, VANIR
 CATEGORY 3: COMFORT, ESSENTIAL
 CATEGORY 4: SOFT
 CATEGORY 5: GRACE, EMBRACE, RUSTIK, NATURAL

SELECTED TEXTILE COLOURS - SEE THE SURFACE SELECTION
 VANIR (193, 243, 373,393, 413, 443, 473, 693, 733, 773, 913, 983)

OPTIONS

DESCRIPTION	PRICE
Felt glides (4 pcs.)	7
Linking device for 3108	65
Small transport dolly for 8 pcs. 3108 chairs, non-upholstered	395
Chair rack for 3108 chairs, mounted under a table top, for non-upholstered chairs only	57

3108

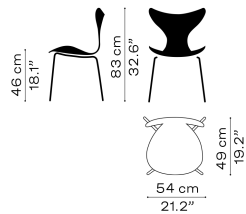

3208

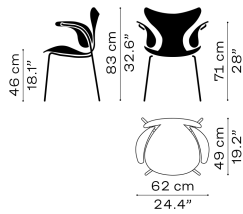

SMALL TRANSPORT DOLLY

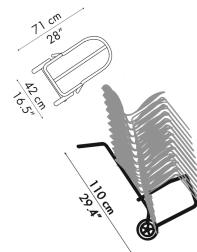



DROP™
ARNE JACOBSEN 1958/2014

11.2023

The Drop™ chair comes with a shell made of ABS plastic and four legs in chromed or powder coated tubular steel. The chair is also available upholstered in a wide range of textile and leather types.

PLASTIC

MODEL	DESCRIPTION	PLASTIC (ABS)
3110	Chair, 43 cm or 46 cm, chromed or powder coated tubular steel base	296

PLASTIC COLOURS - SEE THE SURFACE SELECTION
DEEP CLAY, LIGHT BEIGE, PALE ROSE, OLIVE GREEN, BLACK, WHITE

BASE COLOURS
WARM GRAPHITE, BROWN BRONZE, BLACK, WHITE (ONLY WITH WHITE SHELL), CHROME

FULLY UPHOLSTERED

MODEL	DESCRIPTION	CHRISTIANSHAVN	CATEGORY 1	CATEGORY 2	CATEGORY 3	CATEGORY 4	CATEGORY 5
3110	Chair, 43 cm or 46 cm, handstitched, chromed or powder coated tubular steel base	908	949	990	1.569	1.734	2.065
3110UB	Chair, 43 cm or 46 cm, Essential leather with front stitching and piping, chrome or powder coated tubular steel base				990		

CATEGORY 1: CANVAS, CAPTURE, DIABLO, FAME, REMIX, TONUS
CATEGORY 2: DIVINA, DIVINA MELANGE, DIVINA MD, FIORD, HALLINGDAL, RE-WOOL, STEELCUT, STEELCUT TRIO, SUNNIVA
CATEGORY 3: COMFORT, ESSENTIAL
CATEGORY 4: AURA
CATEGORY 5: GRACE, EMBRACE, RUSTIK, NATURAL

OPTIONS

DESCRIPTION	PRICE
Felt glides (4 pcs.)	7
3110SC Seat cushion, Salsa 3 textile, grey (36)	52
3110SC Seat cushion, Salsa 3 textile, black (39)	52

3110/3110UB

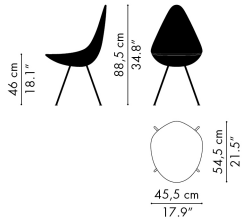



LITTLE GIRAFFE™
ARNE JACOBSEN 1959/2018

11.2023

The Little Giraffe™ chair is upholstered with either a fixed or a removable cover in a wide selection of textiles and leather types. Seat and backrest of the chair are made from PUR-foam moulded around an inner steel frame. Its base is available either with four tubular steel legs or a five-star base made of die-cast aluminium.

MODEL	DESCRIPTION	CHRISTIANSHAVN	CATEGORY 1	CATEGORY 2	CATEGORY 3	CATEGORY 4	CATEGORY 5
3201	Chair, fixed cover, 4 legs, chromed or black powder coated tubular steel base	1.073	1.114	1.238	1.817	2.313	2.726
3201R	Chair, removable cover, 4 legs, chromed or black powder coated tubular steel base	1.156	1.197	1.362			
3211	Swivel chair, fixed cover, height-adjustable, satin brushed or black powder coated aluminium base, 5 castors	1.238	1.321	1.486	2.065	2.478	2.974
3211R	Swivel chair, removable cover, height-adjustable, satin brushed or black powder coated aluminium base, 5 castors	1.404	1.445	1.610			
32C	Removable cover, in textile only	304	321	362			

CATEGORY 1: CANVAS, CAPTURE, DIABLO, FAME, REMIX, TONUS
 CATEGORY 2: DIVINA, DIVINA MELANGE, DIVINA MD, FIORD, HALLINGDAL, RE-WOOL, STEELCUT, STEELCUT TRIO, SUNNIVA
 CATEGORY 3: COMFORT (3201 & 3211), ESSENTIAL
 CATEGORY 4: AURA
 CATEGORY 5: GRACE, EMBRACE, RUSTIK, NATURAL

BASE COLOURS
 3201, 3201R: BLACK, CHROME
 3211, 3211R: BLACK, BRUSHED ALUMINIUM

OPTIONS

DESCRIPTION	PRICE
Hard castors for soft floors with or without brake	No surcharge
Soft castor for hard floors with or without brake	No surcharge

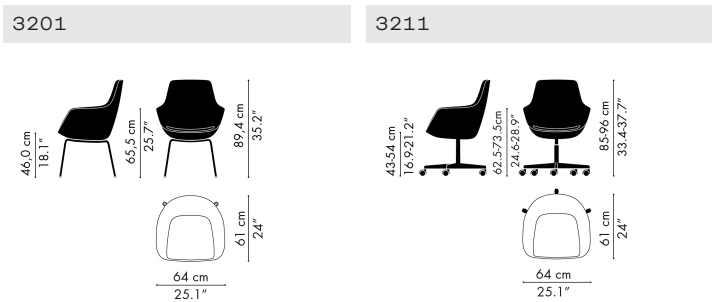



OXFORD™
ARNE JACOBSEN 1965

11.2023

The Oxford™ chair comes fully upholstered in a wide range of textile or leather types and is available with a low or medium back, with or without armrests. The inner shell of the chair is made of a pressure moulded veneer shell covered with cut HR foam. The base of the chair is made of die-cast aluminium and available either as a fixed four-star or five-star base with or without castors, either fixed or height adjustable with tilt mechanism. The bases come in two finishes; satin brushed or powder coated aluminium, while the five-star base is also optionally available in mirror chrome. Optional comfort-enhancing arm pads are available for armrest configurations.

4-STAR BASE

MODEL	DESCRIPTION	CHRISTIANSHAVN	CATEGORY 1	CATEGORY 2	CATEGORY 3	CATEGORY 4	CATEGORY 5
3141T	Chair, low back, fixed seat height, toes	1.734	1.817	1.941	2.230	2.561	3.470
3143T	Chair, medium back, fixed seat height, toes	1.941	2.065	2.147	2.478	2.974	3.800
3241T	Armchair, low back, fixed seat height, toes	1.941	2.065	2.147	2.395	2.726	3.718
3243T	Armchair, medium back, fixed seat height, toes	2.147	2.230	2.395	2.643	4.048	4.048

5-STAR BASE

MODEL	DESCRIPTION	CHRISTIANSHAVN	CATEGORY 1	CATEGORY 2	CATEGORY 3	CATEGORY 4	CATEGORY 5
3171T	Chair, low back, fixed seat height, glides or toes	1.900	1.982	2.065	2.313	2.643	3.635
3173T	Chair, medium back, fixed height, glides or toes	2.065	2.230	2.313	2.643	2.974	3.966
3191T	Chair, low back, height adjustable, tilt, glides or toes	1.941	2.065	2.147	2.395	2.726	3.718
3193T	Chair, medium back, height adjustable, tilt, glides or toes	2.147	2.230	2.395	2.643	3.057	4.048
3271T	Armchair, low back, fixed seat height, glides or toes	2.065	2.230	2.313	2.561	2.891	3.883
3273T	Armchair, medium back, fixed seat height, glides or toes	2.313	2.395	2.478	2.809	3.139	4.131
3291T	Armchair, low back, height adjustable, tilt, glides or toes	2.147	2.230	2.395	2.643	2.974	3.883
3293T	Armchair, medium back, height adjustable, tilt, glides or toes	2.395	2.478	2.561	2.891	3.222	4.214

5-STAR BASE WITH CASTORS

MODEL	DESCRIPTION	CHRISTIANSHAVN	CATEGORY 1	CATEGORY 2	CATEGORY 3	CATEGORY 4	CATEGORY 5
3171W	Chair, low back, fixed seat height, castors	2.147	2.230	2.395	2.643	2.974	3.883
3173W	Chair, medium back, fixed seat height, castors	2.395	2.478	2.561	2.891	3.222	4.214
3191W	Chair, low back, height adjustable, tilt, castors	2.230	2.313	2.478	2.726	3.057	3.966
3193W	Chair, medium back, height adjustable, tilt, castors	2.395	2.561	2.643	2.974	3.304	4.296
3271W	Armchair, low back, fixed seat height, castors	2.395	2.478	2.561	2.809	3.139	4.131
3273W	Armchair, medium back, fixed seat height, castors	2.561	2.643	2.809	3.057	3.470	4.461
3291W	Armchair, low back, height adjustable, tilt, castors	2.478	2.561	2.643	2.891	3.222	4.214
3293W	Armchair, medium back, height adjustable, tilt, castors	2.643	2.726	2.891	3.139	3.470	4.544

CATEGORY 1: CANVAS, CAPTURE, DIABLO, FAME, REMIX, TONUS
 CATEGORY 2: DIVINA, DIVINA MELANGE, DIVINA MD, FIORD, HALLINGDAL, STEELCUT, STEELCUT TRIO, SUNNIVA, RE-WOOL, VIDAR
 CATEGORY 3: COMFORT, ESSENTIAL, SONAR
 CATEGORY 4: SOFT
 CATEGORY 5: GRACE, EMBRACE, RUSTIK, NATURAL

BASE COLOURS: WARM GRAPHITE, BROWN BRONZE, BLACK, SATIN BRUSHED ALUMINIUM

OPTIONS

DESCRIPTION	PRICE
Hard castors for soft floors with or without brake	No surcharge
Soft castor for hard floors with or without brake	No surcharge
Automatic return for chairs with fixed seat height	156
Arm pads in black plastic for chairs upholstered in textile	61
Arm pads in matching leather for chairs upholstered in leather	180
Mirror chromed base (5-star bases)	98
Mirror chromed base and armrests (5-star bases)	197



3141T

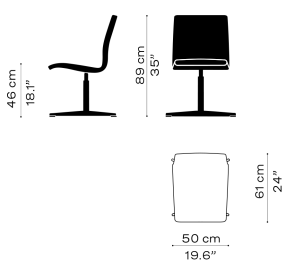

3143T

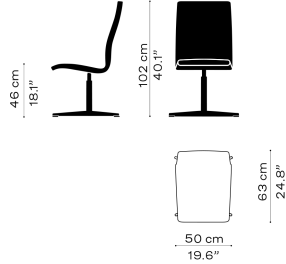

3241T

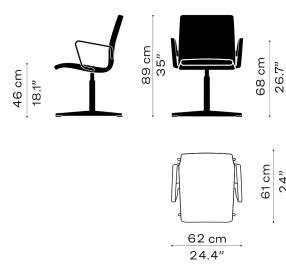

3243T

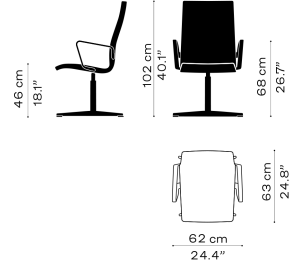

3171T

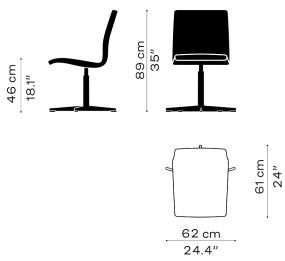

3173T

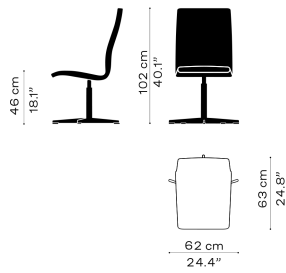

3191T

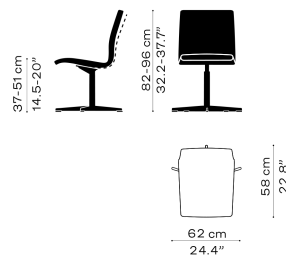

3193T

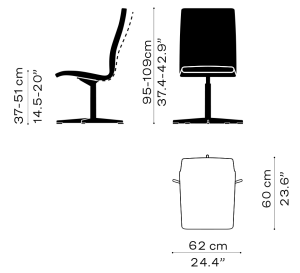

3271T

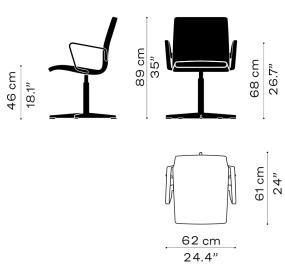

3273T

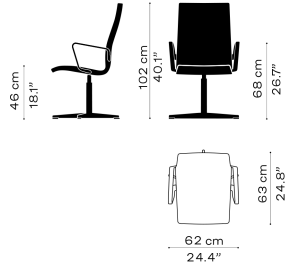

3291T

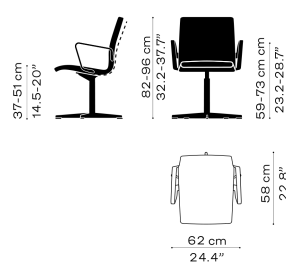

3293T

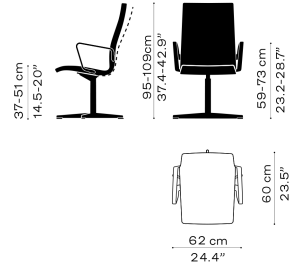

3171W

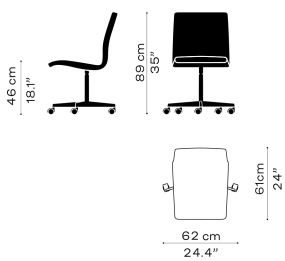

3173W

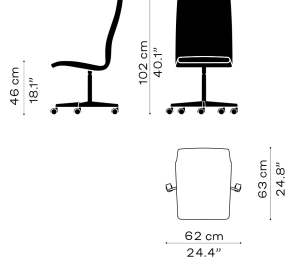

3191W

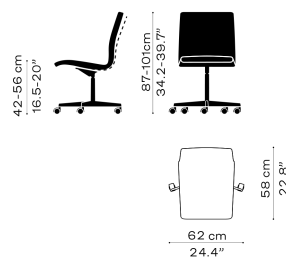

3193W

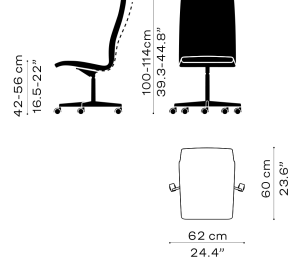

3271W

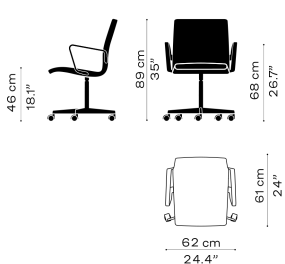

3273W

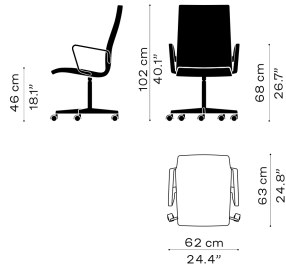

3291W

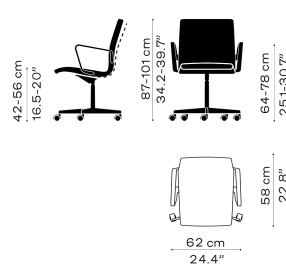

3293W

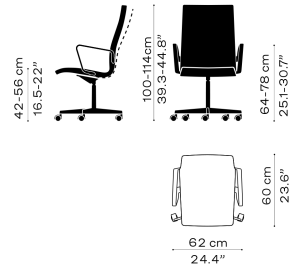



N01™ NENDO 2018

11.2023

The N01™ armchair is made of a solid wood base with seat and backrest in pressure moulded veneer. The fully wooden chair is available in clear lacquered beech, clear lacquered oak and black coloured oak. Optionally, a seat cushion made of textile or leather is available, which can either be mounted with a Velcro fastener or purchased separately as a loose cushion.

MODEL	DESCRIPTION	CLEAR LACQUERED BEECH	BLACK COLOURED OAK	CLEAR LACQUERED OAK
N01	Armchair, seat height 44 cm or 46,5 cm, solid wood base	652	726	726

OPTIONS

DESCRIPTION	PRICE
Seat cushion (loose) in Remix textile dark blue/grey (173), beige (233) or dark brown (393)	73
Seat cushion (loose) in Raw leather, black	98
Seat cushion (fixed, incl. Velcro) in Remix textile dark blue/grey (173), beige (233) or dark brown (393)	106
Seat cushion (fixed, incl. Velcro), in Raw leather, black	131

N01

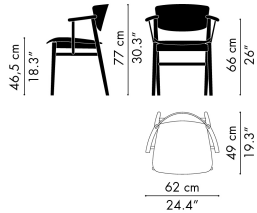



NO2™ RECYCLE NENDO 2019

11.2023

NO2™ Recycle is made from recycled plastic (PP) from household waste. It is available in seven shell colours with four legs made of tubular steel, a sledge base made of solid steel or a die-cast aluminium swivel base. The NO2™ Recycle is also configurable as counter or bar stool with a four-legged base. The chair is available with an optional seat cushion in textile, mounted or sold separately.

MODEL	DESCRIPTION	RECYCLED PLASTIC (PP)	PRICE
N02-10	Chair, stackable (max 10 pcs.), seat height 46 cm, 4 legs, chromed or powder coated tubular steel	263	
N02-11	Armchair, stackable (max 10 pcs.), seat height 46 cm, 4 legs, chromed or powder coated tubular steel	346	
N02-20	Chair, stackable (max 10 pcs.), seat height 46 cm, chromed solid steel sledge base	263	
N02-21	Chair w/welded linking device, stackable (max 10 pcs.), seat height 46 cm, chromed steel sledge base	304	
N02-30	Swivel chair, polished aluminium base, 5 castors	461	
N02-31	Swivel armchair, polished aluminium base, 5 castors	552	
N02-40	Counter stool, stackable (max 4 pcs.), seat height 64 cm, chromed or powder coated tubular steel base	313	
N02-50	Bar stool, stackable (max 4 pcs.), seat height 76 cm, chromed or powder coated tubular steel base	371	

SHELL AND BASE COLOURS
OFF WHITE, GREY, BLACK, DARK ORANGE, DARK RED, LIGHT BLUE, DARK BLUE

OPTIONS

DESCRIPTION	PRICE
Hard castors for soft floors with or without brake	No surcharge
Soft castor for hard floors with or without brake	No surcharge
N02-70 Seat cushion, Just textile in black (60999), dark grey (60121) or light grey (60118)	57
Linking device for N02-20	32
Felt glides (4 pcs.)	7
Small transport dolly for 10 pcs. N02-10, N02-11 or N02-20 chairs	395
Chair rack for N02 chairs, mounted under a table top	57

<p>N02-10</p>	<p>N02-11</p>	<p>N02-20</p>	<p>N02-21</p>	
<p>N02-30</p>	<p>N02-31</p>	<p>N02-40</p>	<p>N02-50</p>	<p>SMALL TRANSPORT DOLLY</p>

CERTIFICATION
The NO2™ Recycle models N02-10 and N02-11 with powder coated legs have achieved the EU-Ecolabel.





NAP™ KASPER SALTO 2010

The NAP™ chair comes with a nylon plastic (PA) shell with a high-gloss back and a matt rippled front. The chair is available in four shell colours with a four-legged base. The base is either made of tubular steel with a chromed or powder coated finish matching the shell or a four-legged wooden base in oak made of pressure moulded veneer. The NAP™ is also configurable as counter or bar stool with a four-legged base. All variants are configurable with or without armrests. The chair is also available with a seat cushion in textile, mounted or purchased separately.

MODEL	DESCRIPTION	PLASTIC (PP)
KS50	Chair, stackable (max 8 pcs.), seat height 45 cm, chromed or powder coated tubular steel base	329
KS52	Chair, seat height 45 cm, oak veneer legs	387
KS58	Counter stool, seat height 64 cm, chromed tubular steel base	594
KS59	Bar stool, seat height 76 cm, chromed tubular steel base	594
KS60	Armchair, stackable (max 8 pcs.), seat height 45 cm, chromed or powder coated tubular steel base	445
KS62	Armchair, seat height 45 cm, oak veneer legs	486
KS68	Counter stool with armrests, seat height 64 cm, chromed tubular steel base	709
KS69	Bar stool with armrests, seat height 76 cm, chromed tubular steel base	709

PLASTIC COLOURS - SEE THE SURFACE SELECTION
MILK WHITE, SILVER GREY, PEPPER GREY, MIDNIGHT BLUE

OPTIONS

DESCRIPTION	PRICE
Small transport dolly for 8 pcs. KS50 or KS60 chairs	395
KS70 seat cushion, Divina Melange textile Light grey (120) or Dark grey (180)	106

KS50	KS52	KS60	KS62
------	------	------	------

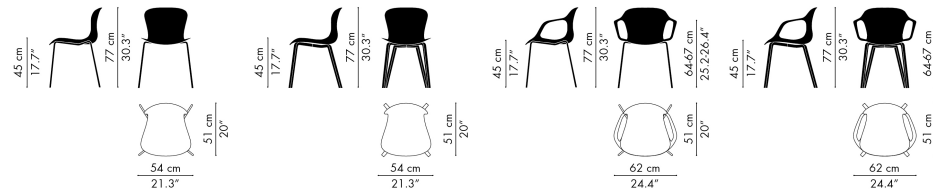

KS58	KS59	KS68	KS69	SMALL TRANSPORT DOLLY
------	------	------	------	-----------------------

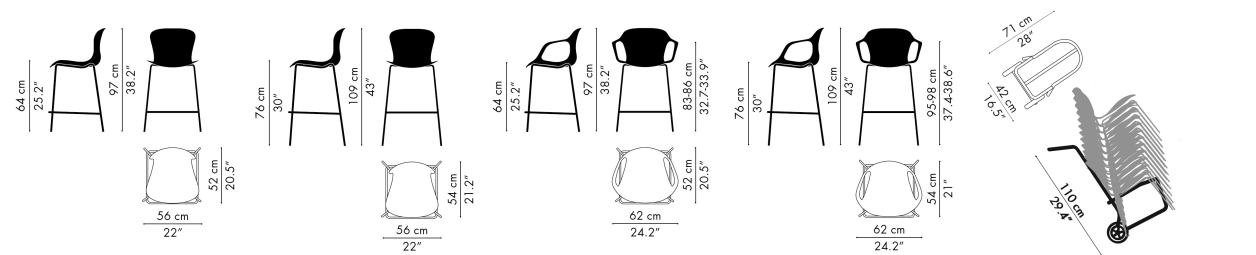



VICO DUO™
VICO MAGISTRETTI 1997/2020

11.2023

The Vico Duo™ chair comes with a pressure moulded veneer shell and is available in two different finishes: Clear lacquered (oak or walnut) or black coloured ash veneer. The shell is also available in front or fully upholstered versions in a wide range of textiles and leather types. Besides a four-legged tubular steel base, the Vico Duo™ is configurable with a sledge base made of solid steel, or as counter or bar stool with a four-legged tubular steel base. The chair is also available with a seat cushion in textile, mounted or purchased separately. Armrests are available on the models detailed below.

MODEL	DESCRIPTION	BLACK COLOURED ASH	CLEAR LACQUERED VENEER
VM110	Chair, stackable (max 10 pcs.), seat height 46 cm, 4 legs, chromed or black powder coated tubular steel base	288	288
VM111	Armchair, stackable (max 8 pcs.), seat height 46 cm, 4 legs, chromed or black powder coated tubular steel base	354	354
VM112	Chair w/welded linking device, stackable (max 8 pcs.), seat height 46 cm, 4 legs, chromed or black powder coated tubular steel base	387	387
VM113	Armchair w/welded linking device, stackable (max 8 pcs.), seat height 46 cm, 4 legs, chromed or black powder coated tubular steel base	478	478
VM114	Chair, stackable (max 8 pcs.), seat height 46 cm, chromed steel sledge base	288	288
VM115	Chair w/welded linking device, stackable (max 8 pcs.), seat height 46 cm, chromed steel sledge base	346	346
VM116	Counter stool, stackable (max 4 pcs.), seat height 64 cm, chromed or black powder coated tubular steel base	362	362
VM118	Bar stool, stackable (max 4 pcs.), seat height 76 cm, chromed or black powder coated tubular steel base	428	428

CLEAR LACQUERED VENEER - SEE THE SURFACE SELECTION
OAK, WALNUT

FRONT UPHOLSTERED - BLACK COLOURED ASH

MODEL	DESCRIPTION	CHRISTIANSHAVN	CATEGORY 1	CATEGORY 2	CATEGORY 3	CATEGORY 4	CATEGORY 5
VM110	Chair, seat height 46 cm, 4 legs with arms, chromed or black powder coated tubular steel base	379	412	470	552	660	825
VM111	Armchair, seat height 46 cm, 4 legs, chromed or black powder coated tubular steel base	437	478	528	610	718	908
VM112	Chair w/welded linking device, seat height 46 cm, 4 legs, chromed or black powder coated tubular steel base	478	511	561	652	759	949
VM113	Armchair w/welded linking device, seat height 46 cm, 4 legs, chromed or black powder coated tubular steel base	561	594	652	734	866	1.032
VM114	Chair, seat height 46 cm, chromed steel sledge base	379	412	470	552	660	825
VM115	Chair w/welded linking device, seat height 46 cm, chromed steel sledge base	428	470	519	610	709	908
VM116	Counter stool, seat height 64 cm, chromed or black powder coated tubular steel base	445	486	536	627	726	908
VM118	Bar stool, seat height 76 cm, chromed or black powder coated tubular steel base	519	552	610	693	800	990

FRONT UPHOLSTERED - CLEAR LACQUERED VENEER

MODEL	DESCRIPTION	CHRISTIANSHAVN	CATEGORY 1	CATEGORY 2	CATEGORY 3	CATEGORY 4	CATEGORY 5
VM110	Chair, seat height 46 cm, 4 legs with arms, chromed or black powder coated tubular steel base	379	412	470	552	660	825
VM111	Armchair, seat height 46 cm, 4 legs, chromed or black powder coated tubular steel base	437	478	528	610	718	908
VM112	Chair w/welded linking device, seat height 46 cm, 4 legs, chromed or black powder coated tubular steel base	478	511	561	652	759	949
VM113	Armchair w/welded linking device, seat height 46 cm, 4 legs, chromed or black powder coated tubular steel base	561	594	652	734	866	1.032
VM114	Chair, seat height 46 cm, chromed steel sledge base	379	412	470	552	660	825
VM115	Chair w/welded linking device, seat height 46 cm, chromed steel sledge base	428	470	519	610	709	908
VM116	Counter stool, seat height 64 cm, chromed or black powder coated tubular steel base	445	486	536	627	726	908
VM118	Bar stool, seat height 76 cm, chromed or black powder coated tubular steel base	519	552	610	693	800	990

CATEGORY 1: BELFAST, CANVAS, CAPTURE, DIABLO, FAME, REMIX, TONUS
 CATEGORY 2: DIVINA, DIVINA MELANGE, DIVINA MD, FIORD, HALLINGDAL, RE-WOOL, STEELCUT, STEELCUT TRIO, SUNNIVA
 CATEGORY 3: COMFORT, ESSENTIAL
 CATEGORY 4: SOFT
 CATEGORY 5: GRACE, EMBRACE, NATURAL

SELECTED TEXTILE COLOURS - SEE THE SURFACE SELECTION
 BELFAST (770593, 770660, 771772, 772062, 772143, 772150, 772255, 774232, 774926, 775139)
 VANIR (193, 243, 373, 393, 413, 443, 473, 693, 733, 773, 913, 983)



FULLY UPHOLSTERED

MODEL	DESCRIPTION	CHRISTIANSHAVN	CATEGORY 1	CATEGORY 2	CATEGORY 3	CATEGORY 4	CATEGORY 5
VM110	Chair, seat height 46 cm, 4 legs with arms, chromed or black powder coated tubular steel base	428	461	511	652	825	1.156
VM111	Armchair, seat height 46 cm, 4 legs, chromed or black powder coated tubular steel base	486	519	569	709	908	1.197
VM112	Chair w/welded linking device, seat height 46 cm, 4 legs, chromed or black powder coated tubular steel base	519	552	610	742	949	1.238
VM113	Armchair w/welded linking device, seat height 46 cm, 4 legs, chromed or black powder coated tubular steel base	610	643	693	825	1.032	1.321
VM114	Chair, seat height 46 cm, chromed steel sledge base	428	461	511	652	825	1.156
VM115	Chair w/welded linking device, seat height 46 cm, chromed steel sledge base	478	511	561	701	908	1.197
VM116	Counter stool, seat height 64 cm, chromed or black powder coated tubular steel base	495	528	577	718	908	1.238
VM118	Bar stool, seat height 76 cm, chromed or black powder coated tubular steel base	561	594	652	792	990	1.280

CATEGORY 1: BELFAST, CANVAS, CAPTURE, DIABLO, FAME, REMIX, TONUS
 CATEGORY 2: DIVINA, DIVINA MELANGE, DIVINA MD, FIORD, HALLINGDAL, RE-WOOL, STEELCUT, STEELCUT TRIO, SUNNIVA
 CATEGORY 3: COMFORT, ESSENTIAL
 CATEGORY 4: SOFT
 CATEGORY 5: GRACE, EMBRACE, RUSTIK, NATURAL

SELECTED TEXTILE COLOURS - SEE THE SURFACE SELECTION
 BELFAST (770593, 770660, 771772, 772062, 772143, 772150, 772255, 774232, 774926, 775139
 VANIR (193, 243, 373, 393, 413, 443, 473, 693, 733, 773, 913, 983)

OPTIONS

DESCRIPTION	PRICE
Small transport dolly for 10 pcs. Vico Duo chairs without arms (except counter and bar stool) and 8 pcs. with arms, non-upholstered	395
Felt glides (4 pcs.)	7
VM170 seat cushion, Just textile black (60999) or dark grey (60121)	57

VM110

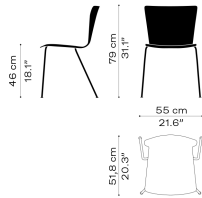

VM111

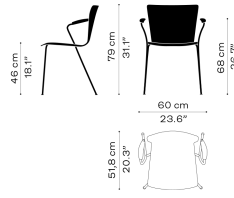

VM112

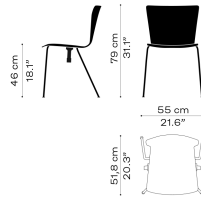

VM113

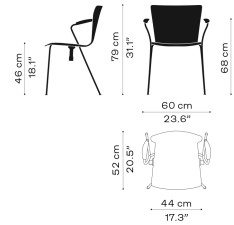

VM114

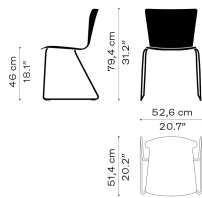

VM115

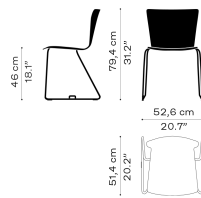

VM116

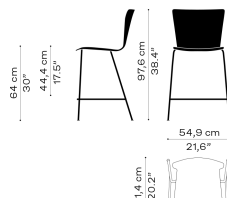

VM118

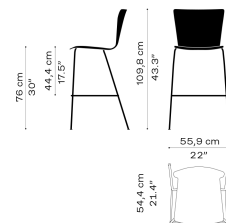

SMALL TRANSPORT DOLLY

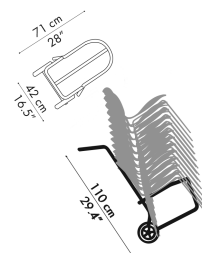



CHINA CHAIR™
HANS J. WEGNER 1944

11.2023

The China Chair™ is available in two types of solid wood: Clear lacquered cherry and black coloured ash. The chair comes with an integrated loose seat cushion, upholstered in leather and available in various leather types.

MODEL	DESCRIPTION	CATEGORY 4	CATEGORY 5
4283	Armchair, seat height 45 cm, solid wood, clear lacquered cherry	7.850	8.180
4283	Armchair, seat height 45 cm, solid wood, black coloured ash	6.280	6.610
4283SC	Replacement seat cushion (loose)	1.073	1.404

CATEGORY 4: AURA
 CATEGORY 5: GRACE, EMBRACE, RUSTIK, NATURAL

4283

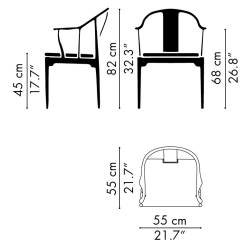



CARIMATE™ VICO MAGISTRETTI 1959

11.2023

Originally designed in 1959 for the Carimate golf club north of Milan, from which the chair takes its name, Vico Magistretti's bold and charismatic design became a highly prized collectable piece from the Italian designer's body of work. A strikingly memorable as well as comfortable chair, the Carimate™ is known for its bold personality and finely detailed construction. Magistretti's charismatic Carimate is available in untreated Beech and black coloured Ash with paper cord seat as a pure and honest expression of the design icon. Perfect for creating a bold and memorable dining setting and a must-have for collectors of Magistretti works.

MODEL	DESCRIPTION	UNTREATED BEECH	BLACK COLOURED ASH
VM120	Armchair, seat height 45 cm	1.114	1.156

VM120

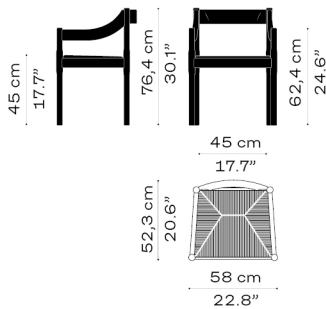



TABURET CECILIE MANZ 2021

11.2023

Taburet is a contemporary, functional stool and occasional side table design that embodies uncompromising precision in its exquisite craftsmanship. Offering tactility and sitting comfort, Taburet is crafted in oiled solid wood with visible grain and a subtly concaved seat.

MODEL	DESCRIPTION	OILED PINE	OILED CHERRY
CM210	Stool, seat height 46 cm	1.445	1.734

CM210

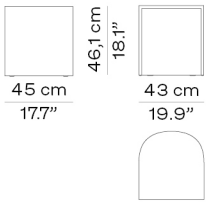



SERIES 3300™
ARNE JACOBSEN 1956

11.2023

Series 3300™ is available both as a lounge chair and a 2- or 3-seater sofa. Its frame is made of chromed tubular steel, while the cushions are made of cut HR foam covering a wooden base structure. The cushions come fully upholstered in a wide range of textiles and leather types. See page 32 for sofas.

MODEL	DESCRIPTION	CHRISTIANSHAVN	CATEGORY 1	CATEGORY 2	CATEGORY 3	CATEGORY 4	CATEGORY 5
3300	Lounge chair, chromed tubular steel base	4.131	4.379	4.627	6.528	8.098	9.503

CATEGORY 1: CANVAS, CAPTURE, DIABLO, FAME, REMIX, TONUS
 CATEGORY 2: DIVINA, DIVINA MELANGE, DIVINA MD, FIORD, HALLINGDAL, RE-WOOL, STEELCUT, STEELCUT TRIO, SUNNIVA
 CATEGORY 3: COMFORT, ESSENTIAL
 CATEGORY 4: AURA
 CATEGORY 5: GRACE, EMBRACE, RUSTIK, NATURAL

3300

SEE PAGE 32 FOR SOFAS

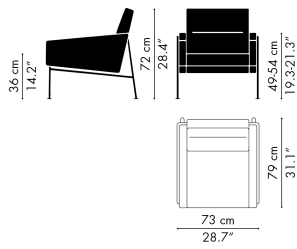



The Egg™ lounge chair comes fully upholstered in a wide range of textiles and leather types. The four-star base consists either of a satin chromed steel column connected to a base in satin brushed aluminium or a powder coated steel column connected to a base in powder coated aluminium. The inner shell is made of a hard moulded foam, padded with a softer foam structure to increase comfort. A matching Egg™ footstool is available in the same base and upholstery options as the Egg™ lounge chair.

MODEL	DESCRIPTION	CHRISTIANSHAVN	CATEGORY 1	CATEGORY 2	CATEGORY 3	CATEGORY 4	CATEGORY 5
3316	Lounge chair, 4-star base, tilt and swivel	6.032	6.362	6.776	9.090	11.569	13.222
3127	Footstool, 4-star base	1.900	1.941	1.982	2.147	2.395	2.726

CATEGORY 1: CANVAS, CAPTURE, DIABLO, FAME, RIME, TONUS
 CATEGORY 2: DIVINA, DIVINA MELANGE, DIVINA MD, FIORD, HALLINGDAL, RE-WOOL, STEELCUT, STEELCUT TRIO, SUNNIVA
 CATEGORY 3: COMFORT, ESSENTIAL
 CATEGORY 4: AURA
 CATEGORY 5: GRACE, EMBRACE, RUSTIK, NATURAL

BASE COLOURS
 SILVER GREY, WARM GRAPHITE, BROWN BRONZE, BLACK, BRUSHED ALUMINIUM

OPTIONS

DESCRIPTION	PRICE
Automatic return for 3316	164

3316

3127

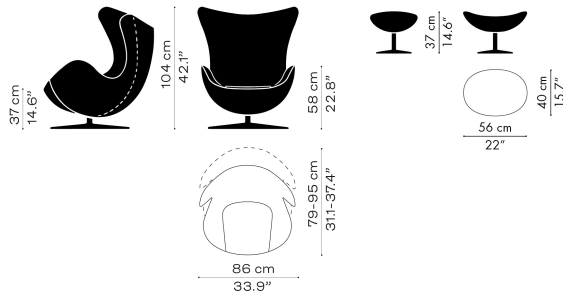



The Swan™ lounge chair comes fully upholstered in a wide range of textiles and leather types. The four-star base consists either of a satin chromed steel column connected to a base in satin brushed aluminium or a powder coated steel column connected to a base in powder coated aluminium. The inner shell is made of a hard moulded foam, padded with a softer foam structure to increase comfort.

MODEL	DESCRIPTION	CHRISTIANSHAVN	CATEGORY 1	CATEGORY 2	CATEGORY 3	CATEGORY 4	CATEGORY 5
3320	Lounge chair, 4-star base, swivel	3.470	3.635	3.800	5.205	6.032	7.106

CATEGORY 1: CAPTURE, DIABLO, FAME, RIME, TONUS
 CATEGORY 2: DIVINA, DIVINA MELANGE, DIVINA MD, FIORD, HALLINGDAL, RE-WOOL, STEELCUT, STEELCUT TRIO, SUNNIVA
 CATEGORY 3: COMFORT, ESSENTIAL
 CATEGORY 4: AURA
 CATEGORY 5: GRACE, EMBRACE, RUSTIK, NATURAL

BASE COLOURS
 SILVER GREY, WARM GRAPHITE, BROWN BRONZE, BLACK, BRUSHED ALUMINIUM

DESCRIPTION	PRICE
Automatic return for 3320	164
Special seat height: 48 cm	44

3320

3320 + 8 CM

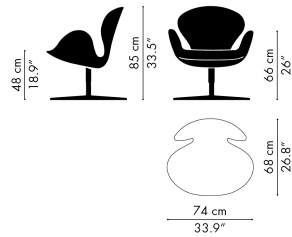
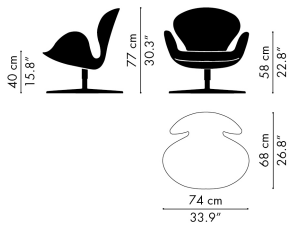



OKSEN™
ARNE JACOBSEN 1968/2017

11.2023

Oksen™ lounge chair comes in three different leather types: Aura and Grace in the colours black and walnut as well as in Essential leather. The five-star base is available in black powder coated aluminium or satin brushed aluminium with a satin brushed steel column. A matching Oksen™ footstool is available in the same base and upholstery options as the Oksen™ lounge chair.

MODEL	DESCRIPTION	CATEGORY 3	CATEGORY 4	CATEGORY 5
4201	Lounge chair, swivel, satin brushed aluminium or black powder coated aluminium	9.090	11.156	12.809
4210	Footstool, satin brushed aluminium or black powder coated aluminium	2.230	2.726	2.974

CATEGORY 3: ESSENTIAL
 CATEGORY 4: AURA (Black or Walnut)
 CATEGORY 5: GRACE (Black or Walnut)

OPTIONS

DESCRIPTION	PRICE
Automatic return for 4201	164

4201

4210

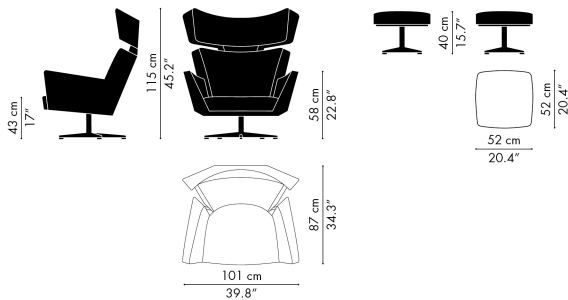



POT™
ARNE JACOBSEN 1959/2017

11.2023

The Pot™ lounge chair comes fully upholstered in a wide range of textiles and leather types. The inner shell is made of a hard moulded foam, padded with a softer foam structure to increase comfort. The lounge chair's base consists of four legs in chromed or Brown Bronze powder coated tubular steel.

MODEL	DESCRIPTION	CHRISTIANSHAVN	CATEGORY 1	CATEGORY 2	CATEGORY 3	CATEGORY 4	CATEGORY 5
3318	Lounge chair, chromed or Brown Bronze powder coated tubular steel base	1.528	1.610	1.817	2.313	2.809	3.222

CATEGORY 1: CANVAS, CAPTURE, DIABLO, FAME, REMIX, RIME, TONUS
 CATEGORY 2: DIVINA, DIVINA MELANGE, DIVINA MD, FIORD, HALLINGDAL, RE-WOOL, STEELCUT, STEELCUT TRIO, SUNNIVA
 CATEGORY 3: COMFORT, ESSENTIAL
 CATEGORY 4: AURA
 CATEGORY 5: GRACE, EMBRACE, RUSTIK, NATURAL

3318

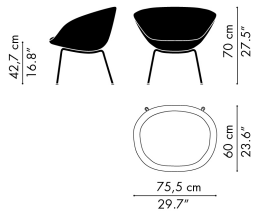



The Lissoni Sofa™ is a fully upholstered sofa series and comes in a variety of sizes and corner configurations. The sofa cushions consist of a core of cut foam and a channel sewed comfort-enhancing cover stuffed with synthetic flakes and feathers. The frame is either made of matt brushed stainless steel or powder coated steel. The Lissoni Sofa™ is available in a wide range of textiles and leather types.

MATT BRUSHED STAINLESS STEEL FRAME

MODEL	DESCRIPTION	CHRISTIANSHAVN	CATEGORY 1	CATEGORY 2	CATEGORY 3	CATEGORY 4	CATEGORY 5
PL111S	Lounge chair	3.222	3.387	3.718	4.379	4.875	6.280
PL111	Lounge chair	3.718	4.131	4.214	4.875	5.619	7.189

POWDER COATED STEEL FRAME

MODEL	DESCRIPTION	CHRISTIANSHAVN	CATEGORY 1	CATEGORY 2	CATEGORY 3	CATEGORY 4	CATEGORY 5
PL111S	Lounge chair	2.643	2.809	3.057	3.635	3.966	5.123
PL111	Lounge chair	3.057	3.387	3.470	3.966	4.627	5.866

CATEGORY 1: CANVAS, CAPTURE, DIABLO, FAME, REMIX, TONUS
 CATEGORY 2: CLAY, DIVINA, DIVINA MELANGE, DIVINA MD, FIORD, HALLINGDAL, MOSS, RE-WOOL, STEELCUT, STEELCUT TRIO, SUNNIVA
 CATEGORY 3: COMFORT, ESSENTIAL
 CATEGORY 4: SOFT
 CATEGORY 5: GRACE, EMBRACE, RUSTIK, NATURAL

BASE COLOURS
 WARM GRAPHITE, BROWN BRONZE, BLACK, MATT BRUSHED STAINLESS STEEL

PL111S

PL111

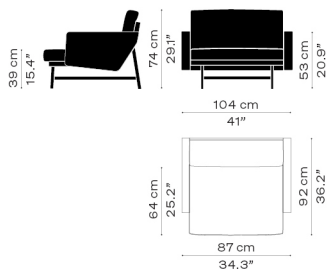
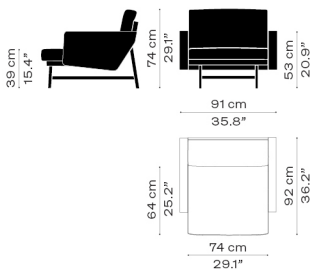



The Ro™ lounge chair comes fully upholstered in a wide range of textiles. Single textile or a mix of two textiles; one textile for the shell and one for the cushions. The base is available with four legs in brushed aluminium or solid oak with a clear lacquer finish. A matching Ro™ footstool is available in the same base and upholstery options as the Ro™ lounge chair. In 2022, designer Jaime Hayon has curated a new and exclusive textile selection for his Ro™ and Fri™ lounge chairs for Fritz Hansen, resting on four legs in brushed aluminium.

MODEL	DESCRIPTION	CHRISTIANSHAVN	CATEGORY 1	CATEGORY 2	CATEGORY 3
JH1	Lounge chair, brushed aluminium legs	2.726	2.809	2.809	3.635
JH2	Lounge chair, solid oak legs	2.726	2.809	2.809	3.635
JH11	Footstool, brushed aluminium legs	792	825	866	1.032
JH12	Footstool, solid oak legs	792	825	866	1.032

CATEGORY 1: CANVAS (ONLY CUSHIONS & FOOTSTOOL), CAPTURE, DIABLO (ONLY CUSHIONS & FOOTSTOOL), FAME, MOOD, REMIX (ONLY CUSHIONS & FOOTSTOOL), RIME, TONUS
 CATEGORY 2: DIVINA, DIVINA MD, DIVINA MELANGE, FIORD, HALLINGDAL, NABIS, RE-WOOL, SAFIRE, STEELCUT, STEELCUT TRIO, SUNNIVA, TWILL WEAVE, VIDAR
 CATEGORY 3: RAAS

JH1

JH2

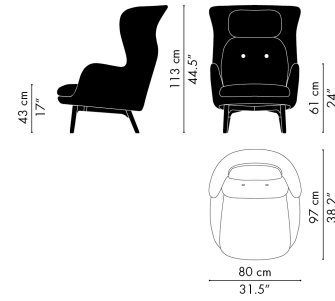
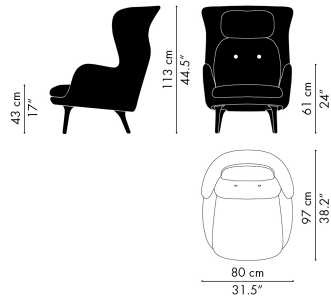

JH11

JH12

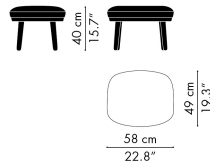
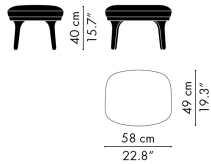



FRI™
JAIME HAYON 2015

The Fri™ lounge chair comes fully upholstered in a wide range of textiles. Single textile or a mix of two textiles; one textile for the shell and one for the cushions. The base is available with four legs in brushed aluminium or solid oak with a clear lacquer finish. A matching Fri™ footstool is available in the same base and upholstery options as the Fri™ lounge chair. In 2022, designer Jaime Hayon has curated a new and exclusive textile selection for his Ro™ and Fri™ lounge chairs for Fritz Hansen, resting on four legs in brushed aluminium.

MODEL	DESCRIPTION	CHRISTIANSHAVN	CATEGORY 1	CATEGORY 2
JH4	Lounge chair, brushed aluminium legs	2.478	2.561	2.561
JH5	Lounge chair, solid oak legs	2.478	2.561	2.561
JH14	Footstool, brushed aluminium legs	792	825	825
JH15	Footstool, solid oak legs	792	825	825

CATEGORY 1: CANVAS, CAPTURE, FAME, REMIX, RIME, TONUS
 CATEGORY 2: DIVINA, DIVINA MD, DIVINA MELANGE, FIORD, HALLINGDAL, RE-WOOL, SAFIRE, STEELCUT, STEELCUT TRIO, SUNNIVA, VIDAR

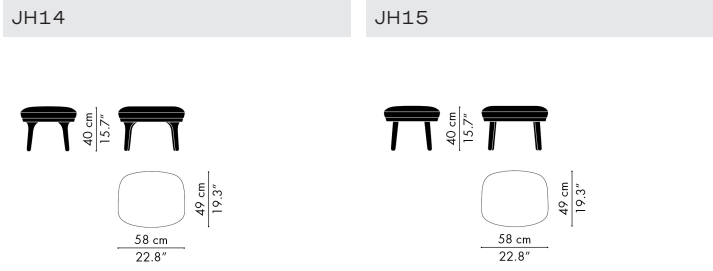
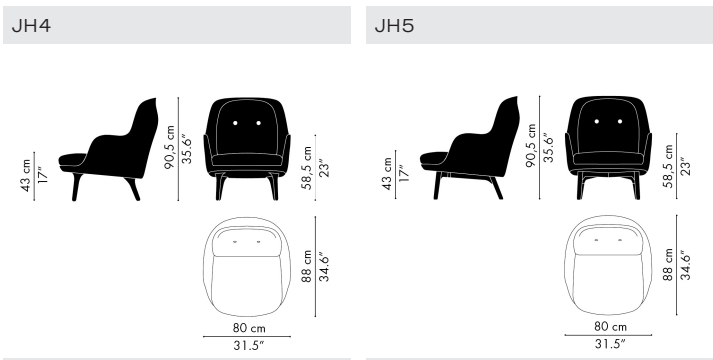



VIA57™
BJARKE INGELS IN COLLABORATION WITH KIBISI 2016

11.2023

VIA57™ lounge chair comes fully upholstered in a range of textiles. The wooden base is made of solid oak with a clear lacquer finish. Seat and back are composed of soft moulded PE foam around an inner steel frame.

MODEL	DESCRIPTION	CHRISTIANSHAVN	CATEGORY 1	CATEGORY 2	CATEGORY 3
BIO1	Lounge chair, solid oak base	2.147	2.147	2.313	2.726

CATEGORY 1: CAPTURE, MESSENGER, TONUS

CATEGORY 2: DIVINA, DIVINA MD, DIVINA MELANGE, FIORD, HALLINGDAL, MERIT, RE-WOOL, STEELCUT, STEELCUT TRIO, SUNNIVA

CATEGORY 3: GENTLE

BIO1

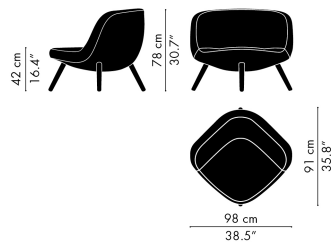



FRED™
JAIME HAYON 2019

11.2023

The Fred™ lounge chair is available in two types of solid wood and a total of four different finishes: Black coloured ash, clear lacquered (oak or walnut stained oak) or oiled oak. The upholstered cushions are available in a variety of textile and leather types.

MODEL	DESCRIPTION	CHRISTIANSHAVN	CATEGORY 1	CATEGORY 2	CATEGORY 3	CATEGORY 4
JH97	Lounge chair, Black coloured ash	1.900	1.982	2.065	2.395	2.809
JH97	Lounge chair, Walnut stained oak	1.900	1.982	2.065	2.395	2.809
JH97	Lounge chair, Clear lacquered oak	1.982	2.065	2.147	2.478	2.891
JH97	Lounge chair, Natural oiled oak	1.982	2.065	2.147	2.478	2.891

CATEGORY 1: BELFAST
 CATEGORY 2: HARALD, HALLINGDAL, RE-WOOL
 CATEGORY 3: ESSENTIAL
 CATEGORY 4: RIA

SELECTED TEXTILE COLOURS - SEE THE SURFACE SELECTION
 BELFAST (770593, 770660, 771772, 772062, 772143, 772150, 772255, 774232, 774926, 775139)

JH97

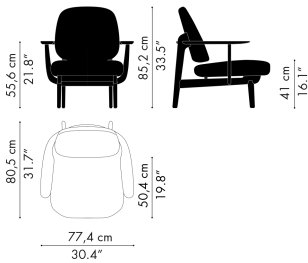



LET™
SEBASTIAN HERKNER 2020

11.2023

The Let™ lounge chair comes fully upholstered and is available in a wide range of textiles and leather. Inner seat and backrest of the chair are made from PUR-foam moulded around an inner steel frame. The four-legged base of the Let™ lounge chair is available either in solid wood or tubular steel. The wooden bases come with a clear lacquered oak, clear lacquered ash or black coloured ash finish, while steel bases are available in chrome or powder coated in Black, Warm Graphite or Brown Bronze.

MODEL	DESCRIPTION	CHRISTIANSHAVN	CATEGORY 1	CATEGORY 2	CATEGORY 3
SH200	Lounge chair, wooden base	1.569	1.652	1.734	1.900
SH210	Lounge chair, chromed or powder coated tubular steel base	1.486	1.569	1.652	1.817

CATEGORY 1: CANVAS, REMIX, FAME, TONUS, HUE

CATEGORY 2: DIVINA, DIVINA MD, DIVINA MELANGE, FIORD, HALLINGDAL, RE-WOOL, STEELCUT, STEELCUT TRIO, SUNNIVA, VIDAR

CATEGORY 3: ESSENTIAL

BASE COLOURS

SH200: CLEAR LACQUERED OAK, CLEAR LACQUERED ASH OR BLACK COLOURED ASH

SH210: WARM GRAPHITE, BROWN BRONZE, BLACK, CHROME

SH200

SH210

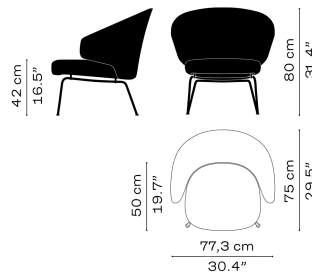
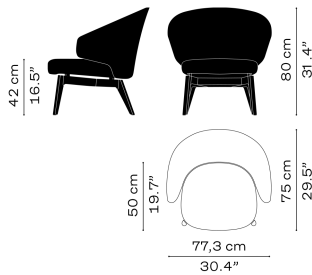

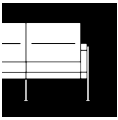

SERIES 3300™
ARNE JACOBSEN 1956

11.2023

Series 3300™ is available both as a lounge chair and a 2- or 3-seater sofa. Its frame is made of chromed tubular steel, while the cushions are made of cut HR foam covering a wooden base structure. The cushions come fully upholstered in a wide range of textiles and leather types. See page 22 for lounge chair.

MODEL	DESCRIPTION	CHRISTIANSHAVN	CATEGORY 1	CATEGORY 2	CATEGORY 3	CATEGORY 4	CATEGORY 5
3302	2-seater sofa, chromed tubular steel base	6.114	6.445	6.776	9.916	11.569	13.635
3303	3-seater sofa, chromed tubular steel base	8.098	8.676	9.090	12.809	15.288	17.767
	Additional modules for Series 3300, chromed tubular steel base	1.982	2.147	2.230	3.222	3.552	4.131

CATEGORY 1: CANVAS, CAPTURE, DIABLO, FAME, REMIX, TONUS
 CATEGORY 2: DIVINA, DIVINA MELANGE, DIVINA MD, FIORD, HALLINGDAL, RE-WOOL, STEELCUT, STEELCUT TRIO, SUNNIVA
 CATEGORY 3: COMFORT, ESSENTIAL
 CATEGORY 4: AURA
 CATEGORY 5: GRACE, EMBRACE, RUSTIK, NATURAL

3302

3303

SEE PAGE 22 FOR LOUNGE CHAIR

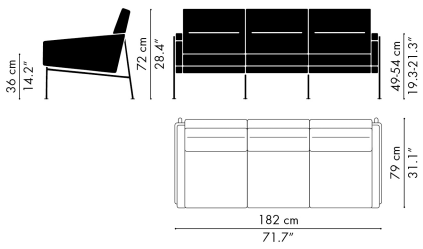
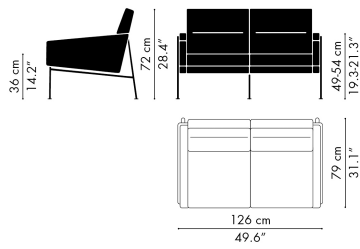



SWAN SOFA™
ARNE JACOBSEN 1958

11.2023

The Swan™ sofa comes fully upholstered in a wide range of textiles and leather types. The sofa rests on a shaker base in satin brushed aluminium. The inner shell is made of a hard moulded foam, padded with a comfort-enhancing foam structure with lower density.

MODEL	DESCRIPTION	CHRISTIANSHAVN	CATEGORY 1	CATEGORY 2	CATEGORY 3	CATEGORY 4	CATEGORY 5
3321	2-seater sofa, shaker base, satin brushed aluminium	7.354	7.685	8.180	10.742	12.395	14.048

CATEGORY 1: CAPTURE, DIABLO, FAME, TONUS

CATEGORY 2: DIVINA, DIVINA MELANGE, DIVINA MD, FIORD, HALLINGDAL, RE-WOOL, STEELCUT, STEELCUT TRIO, SUNNIVA

CATEGORY 3: COMFORT, ESSENTIAL

CATEGORY 4: AURA

CATEGORY 5: GRACE, EMBRACE, RUSTIK, NATURAL

3321

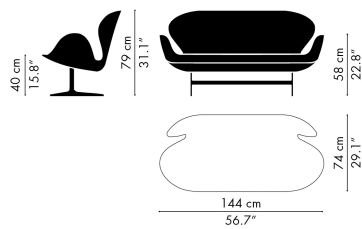



PL112S

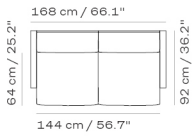

PL112

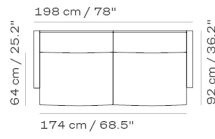

PL113S

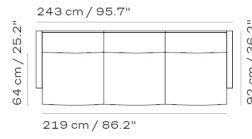

PL113

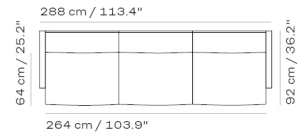

PL114S L

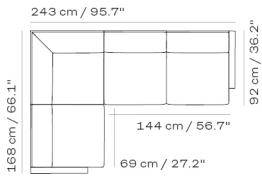

PL114S R

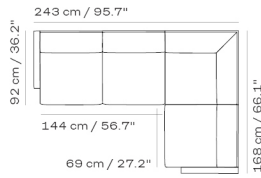

PL114 L

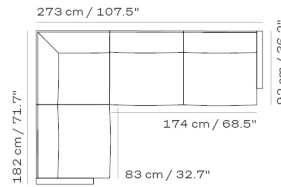

PL114 R

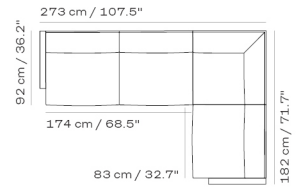

PL115S

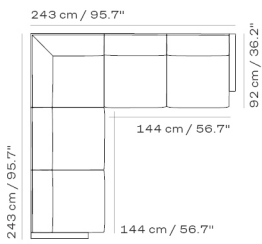

PL115

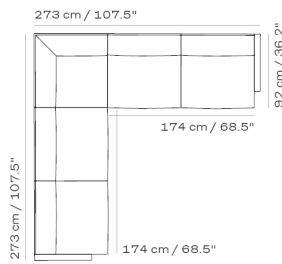

PL116S L

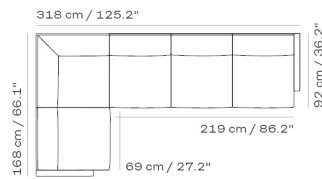

PL116S R

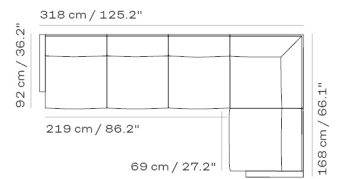

PL116 L

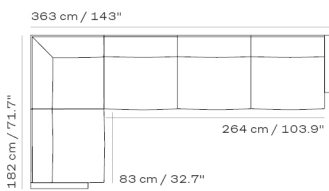

PL116 R

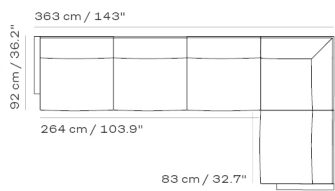

PL117S L

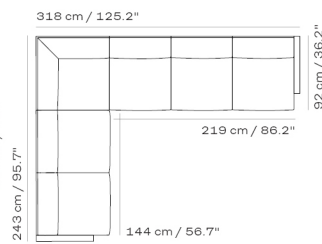

PL117S R

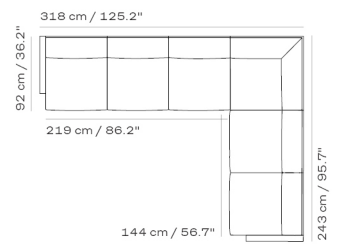

PL117 L

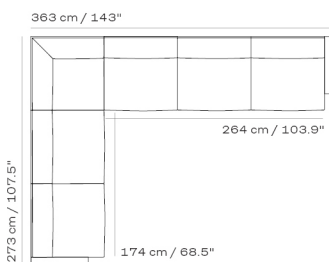

PL117 R

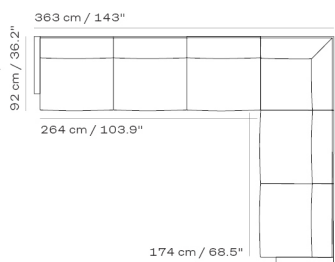

PL118S

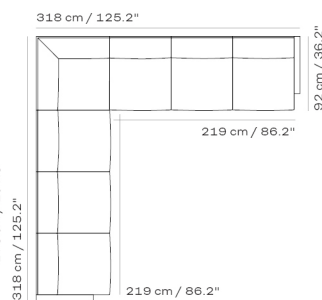

PL118

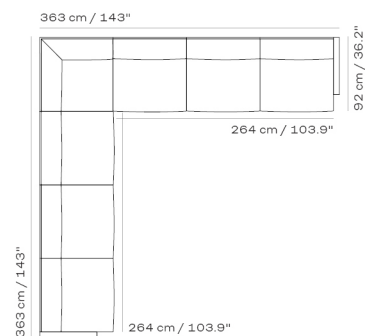



ALPHABET™ SOFA SERIES
PIERO LISSONI 2008

11.2023

The Alphabet™ Sofa Series is a modular sofa system with units that can be combined in a variety of ways. The fully upholstered seat, back and armrest units come in a wide range of textiles, which can be removed for cleaning or replacement. You can choose to include a piping along the edges on both seat, back and armrests.

MODEL	DESCRIPTION	CHRISTIANSHAVN	CATEGORY 1	CATEGORY 2
PL210-1	2-seater sofa, 1 corner backrest, 1 backrest, 1 armrest	4.461	4.709	4.957
PL210-2	2-seater sofa, 1 corner backrest, 1 backrest, 1 armrest	4.461	4.709	4.957
PL210-3	2-seater sofa, 1 corner backrest, 1 backrest	3.966	4.131	4.379
PL210-4	2-seater sofa, 1 corner backrest, 1 backrest	3.966	4.131	4.379
PL240-1	2-seater sofa, 1 backrest, 2 armrests	4.544	4.792	5.040
PL240-2	2-seater sofa, 1 corner backrest, 1 backrest, 1 armrest	4.792	5.040	5.288
PL240-3	2-seater sofa, 1 corner backrest, 1 backrest, 1 armrest	4.792	5.040	5.288
PL240-4	2-seater sofa, 1 corner backrest, 1 backrest	4.131	4.379	4.627
PL240-5	2-seater sofa, 1 corner backrest, 1 backrest	4.131	4.379	4.627
PL255-1	3-seater sofa, 1 backrest, 2 armrests	5.288	5.619	5.866
PL270-1	3-seater sofa, 1 backrest, 2 armrests	5.453	5.784	6.032
PL300-1	3-seater sofa, 1 corner backrest, 2 backrests, 1 armrest	6.197	6.528	6.858
PL300-2	3-seater sofa, 1 corner backrest, 2 backrests, 1 armrest	6.197	6.528	6.858
PL300-3	4-seater sofa, 1 corner backrest, 2 backrests	7.023	7.437	7.850
PL300-4	4-seater sofa, 1 corner backrest, 2 backrests	7.023	7.437	7.850

MODEL	DESCRIPTION	CHRISTIANSHAVN	CATEGORY 1	CATEGORY 2
PL75-105	Sofa seat unit	1.032	1.073	1.156
PL90-105	Sofa seat unit	1.114	1.197	1.238
PL120-105	Sofa seat unit	1.280	1.321	1.404
PL120-120	Sofa seat unit	1.404	1.486	1.569

BASE UNITS - BACK

MODEL	DESCRIPTION	CHRISTIANSHAVN	CATEGORY 1	CATEGORY 2
PL75-30	Sofa back unit	544	569	594
PL90-30	Sofa back unit	594	627	660
PL120-30	Sofa back unit	660	693	734
PL150-30	Sofa back unit	792	825	908
PL180-30	Sofa back unit	908	949	990
PL240-30	Sofa back unit	1.032	1.073	1.156
PL255-30	Sofa back unit	1.114	1.156	1.238
PL270-30	Sofa back unit	1.156	1.238	1.280
PL90-90-30	Corner backrest	817	866	908

BASE UNITS - ARMREST

MODEL	DESCRIPTION	CHRISTIANSHAVN	CATEGORY 1	CATEGORY 2
PL60-30	Armrest	486	511	528

MODEL	DESCRIPTION	CHRISTIANSHAVN	CATEGORY 1	CATEGORY 2
PLO01	Additional sofa cushion (1 pcs.)	147	156	180

CATEGORY 1: CANVAS, CAPTURE, DIABLO, FAME, HUE, REMIX, TONUS
CATEGORY 2: DIVINA, DIVINA MELANGE, DIVINA MD, FIORD, HALLINGDAL, KARAKORUM, RE-WOOL, STEELCUT, STEELCUT TRIO, SUNNIVA

ALPHABET COVERS ARE AVAILABLE FOR ALL MODULES AT 35% OF THE MODULE PRICE
PIPING ALONG THE EDGES ON BOTH SEAT, BACK AND ARMRESTS IS AVAILABLE AT NO ADDITIONAL COST



PL210-1

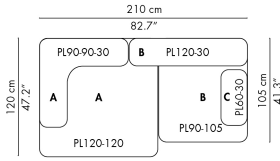

PL210-2

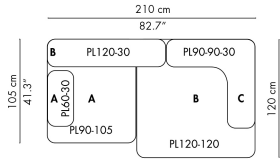

PL210-3

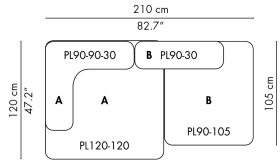

PL210-4

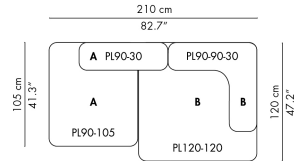

PL240-1

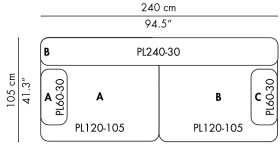

PL240-2

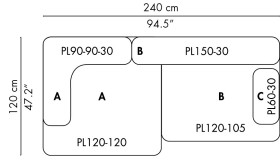

PL240-3

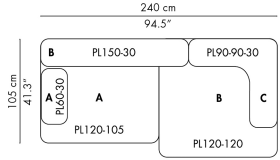

PL240-4

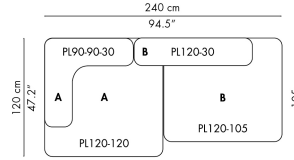

PL240-5

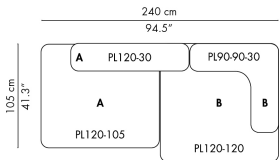

PL255-1

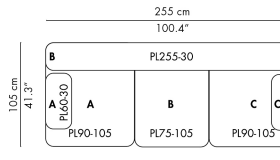

PL270-1

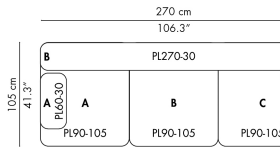

PL300-1

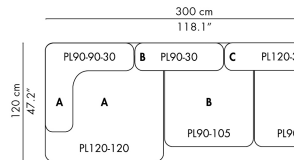

PL300-2

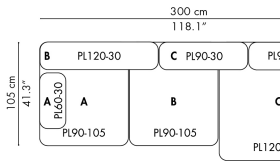

PL300-3

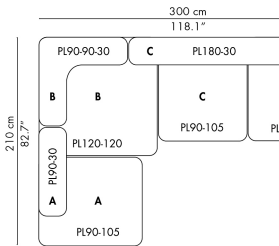

PL300-4

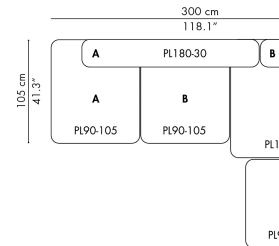

PL75-105

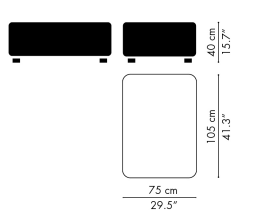

PL90-105

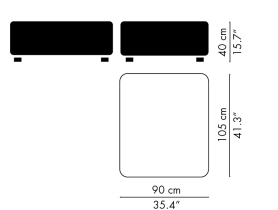

PL120-105

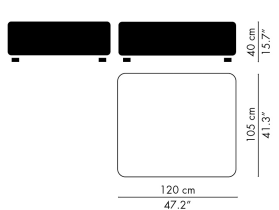

PL120-120

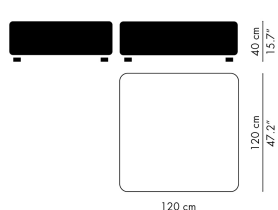

PL90-90-30

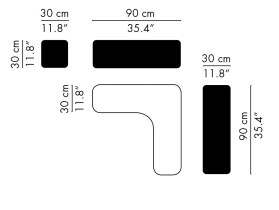

PL75-30

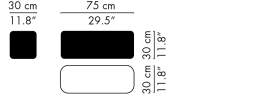

PL90-30



PL120-30

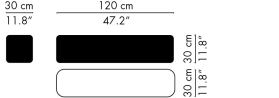

PL150-30

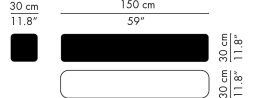

PL180-30

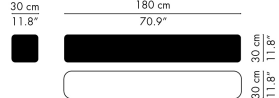

PL240-30

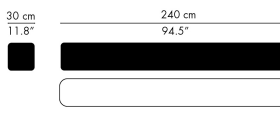

PL255-30

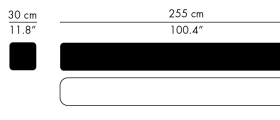

PL270-30

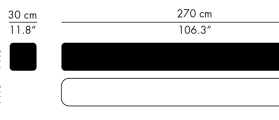

PL60-30

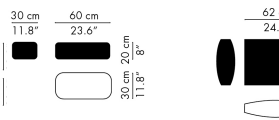

PL001

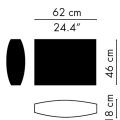



FAVN™
JAIME HAYON 2011

11.2023

The Favn™ sofa comes in a wide range of textiles. It is available with a single coherent textile or a mix of up to three textiles; one textile for the shell and base, a second for the seat and back cushions and third textile for the small decorative cushions. The inner shell of the sofa is made of a hard moulded foam, padded with a soft, comfort-enhancing foam structure. The legs are made of brushed aluminium and a set of felt glides (for soft wooden floors) comes with the sofa as a standard.

MODEL	DESCRIPTION	CHRISTIANSHAVN	CATEGORY 1	CATEGORY 2
JH3	3-seater sofa, brushed aluminium legs incl. 2 loose decorative cushions	9.090	9.503	9.503

OPTIONS

MODEL	DESCRIPTION	CHRISTIANSHAVN	CATEGORY 1	CATEGORY 2
JH9	Additional decorative sofa cushion (1 pcs.)	238	263	263

CATEGORY 1: CANVAS (ONLY SEAT/BACK & DECORATIVE CUSHIONS), CAPTURE, DIABLO (ONLY SEAT/BACK & DECORATIVE CUSHIONS), FAME, REMIX (ONLY SEAT/BACK & DECORATIVE CUSHIONS), TONUS
 CATEGORY 2: DIVINA, DIVINA MELANGE, DIVINA MD, FIORD, HALLINGDAL, RE-WOOL, STEELCUT, STEELCUT TRIO, SUNNIVA

JH3

JH9

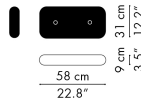
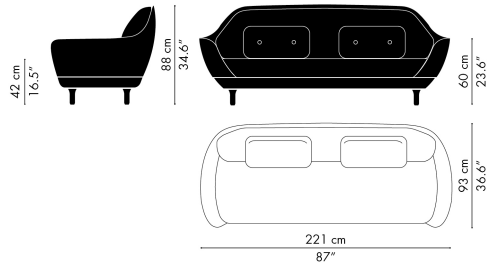



Lune™ is a modular sofa available in nine standard configurations featuring six different modules. The various modules can also be individually combined to create customised configurations. Lune™ comes fully upholstered in a variety of textiles and leather types. The base is available in brushed aluminium, or in two solid wood options: Clear lacquered oak or black coloured oak.

MODEL	DESCRIPTION	CHRISTIANSHAVN	CATEGORY 1	CATEGORY 2	CATEGORY 4	CATEGORY 5
JH200	Sofa, 2-seater, wooden or aluminium base	3.883	4.131	4.544	9.090	11.982
JH300	Sofa, 3-seater, wooden or aluminium base	5.453	5.701	6.362	11.982	16.528
JH301	Sofa, 3-seater with left chaise longue, wooden or aluminium base	6.280	6.610	7.354	12.809	18.180
JH302	Sofa, 3-seater with right chaise longue, wooden or aluminium base	6.280	6.610	7.354	12.809	18.180
JH400	Sofa, 4-seater, wooden or aluminium base	7.023	7.354	8.098	14.875	20.660
JH500	Sofa, 5-seater, wooden or aluminium base	8.676	9.090	9.916	17.767	25.205
JH510	Sofa, 5-seater with corner, wooden or aluminium base	10.329	10.742	11.569	20.247	29.751
JH600	Sofa, 6-seater, wooden or aluminium base	11.156	11.569	12.809	20.660	31.404
JH610	Sofa, 6-seater with corner, wooden or aluminium base	11.982	12.395	13.635	23.139	34.296

SOFA MODULES

MODEL	DESCRIPTION	CHRISTIANSHAVN	CATEGORY 1	CATEGORY 2	CATEGORY 4	CATEGORY 5
JH001	Sofa central module, wooden or aluminium base	1.817	1.900	2.065	3.470	4.957
JH002L	Sofa arm module left, wooden or aluminium base	2.065	2.147	2.395	4.214	5.949
JH002R	Sofa arm module right, wooden or aluminium base	2.065	2.147	2.395	4.214	5.949
JH003	Sofa corner module, wooden or aluminium base	2.809	2.891	3.139	5.205	7.437
JH004L	Sofa chaise longue module left, wooden or aluminium base	2.809	2.891	3.139	5.536	7.767
JH004R	Sofa chaise longue module right, wooden or aluminium base	2.809	2.891	3.139	5.536	7.767

CATEGORY 1: CANVAS, CAPTURE, DIABLO, FAME, LINARA, REMIX, TONUS
 CATEGORY 2: DIVINA, DIVINA MELANGE, DIVINA MD, FIORD, HALLINGDAL, RE-WOOL, STEELCUT, STEELCUT TRIO, SUNNIVA
 CATEGORY 4: AURA, SOFT
 CATEGORY 5: EMBRACE

BASE COLOURS
 BRUSHED ALUMINIUM, CLEAR LACQUERED OAK, BLACK COLOURED OAK

SELECTED TEXTILE COLOURS - SEE THE SURFACE SELECTION
 LINARA (2494/198, 2494/324, 2494/118, 2494/340, 2494/30, 2494/237)



JH200

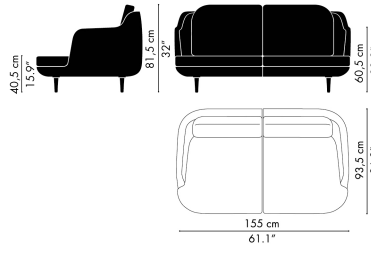

JH300

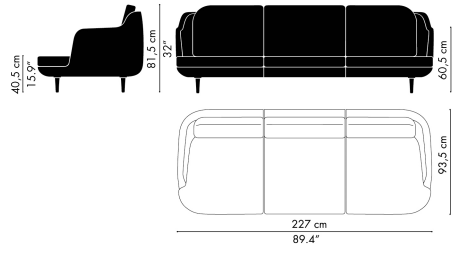

JH301

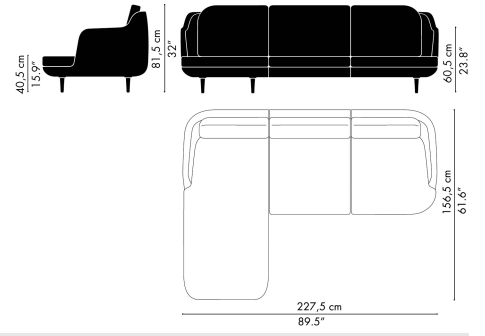

JH302

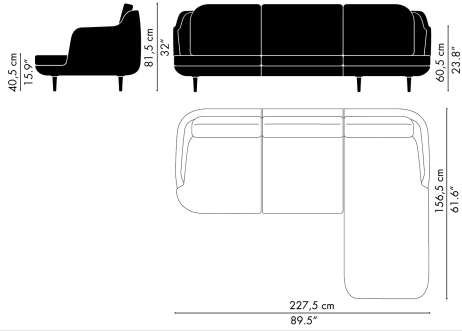

JH400

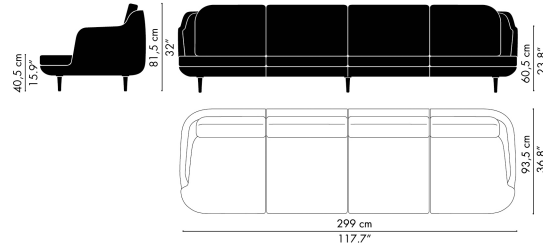

JH500

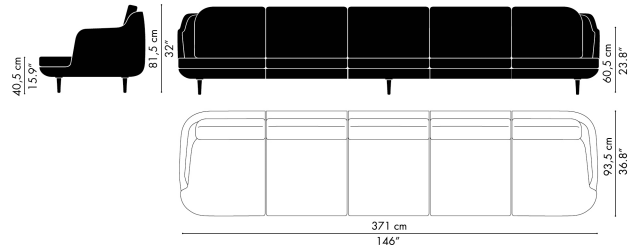

JH600

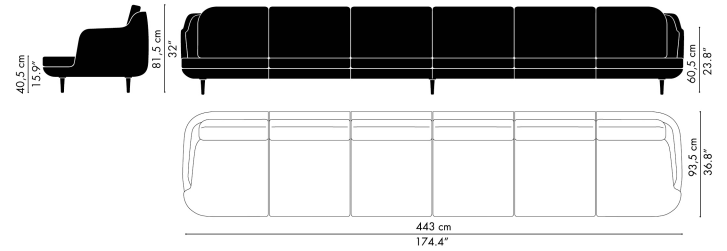

JH510

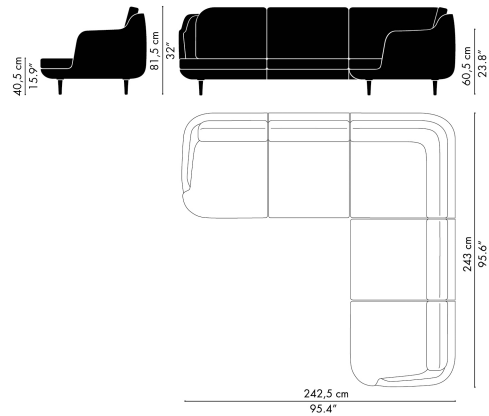

JH610

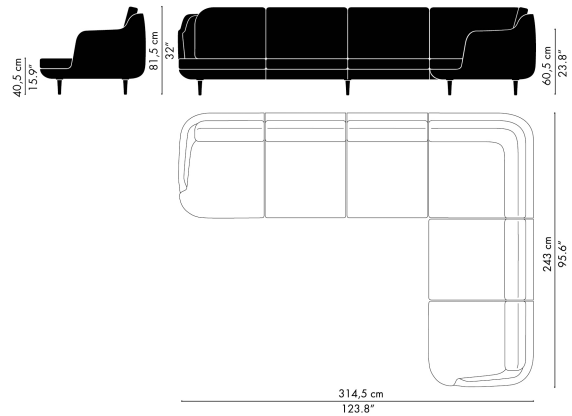

JH001

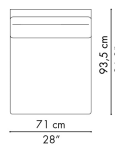

JH002L

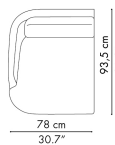

JH002R



JH003

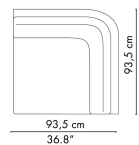

JH004L



JH004R

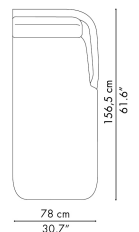



RO™ SOFA
JAIME HAYON 2017

11.2023

The Ro™ Sofa comes fully upholstered in a wide range of textiles. As a single textile or a mix of two textiles; one textile for the shell and one for the cushions. The base consists of four legs in brushed aluminium or is available wooden base in solid oak with a clear lacquer finish.

MODEL	DESCRIPTION	CHRISTIANSHAVN	CATEGORY 1	CATEGORY 2
JH110	2-seater sofa, brushed aluminium legs	5.536	5.784	5.784
JH120	2-seater sofa, solid oak base	5.949	6.280	6.280

CATEGORY 1: CANVAS (ONLY CUSHIONS), CAPTURE, DIABLO (ONLY CUSHIONS), FAME, REMIX (ONLY CUSHIONS), TONUS
 CATEGORY 2: DIVINA, DIVINA MELANGE, DIVINA MD, FIORD, HALLINGDAL, RE-WOOL, STEELCUT, STEELCUT TRIO, SUNNIVA

JH110 **JH120**

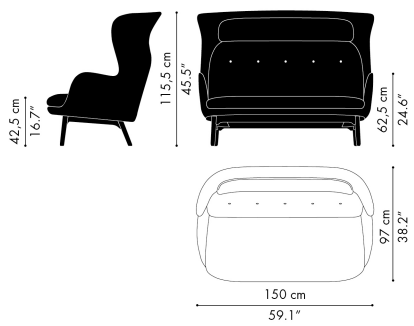
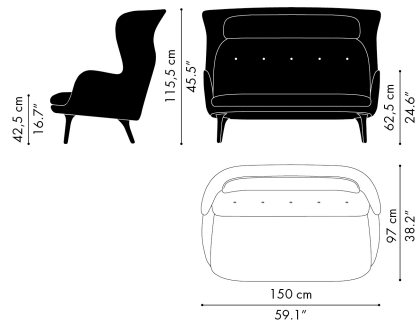



PLENUM™ JAIME HAYON 2018

11.2023

Plenum™ is a high-back sofa system available as a one-, two- or three-seater. It offers features such as power plug and mounted side tables. Two table variants are also available.

SOFAS

MODEL	DESCRIPTION	CHRISTIANSHAVN	CATEGORY 1	CATEGORY 2
JH1001	One seater sofa, black powder coated steel base	5.040	5.288	5.701
JH1002	Two seater sofa, black powder coated steel base	6.528	6.858	7.354
JH1003	Three seater sofa, black powder coated steel base	7.685	8.098	8.676

CATEGORY 1: CANVAS, CAPTURE, FAME, REMIX, TONUS, MESSENGER
 CATEGORY 2: DIVINA, DIVINA MELANGE, DIVINA MD, FIORD, HALLINGDAL, RE-WOOL, STEELCUT, STEELCUT TRIO

TABLES

MODEL	DESCRIPTION	LAMINATE (POLYREY)
JH70	Side sofa table, light grey laminate, black base	792
JH75	Coffee table, light grey laminate, black base	990
JH80	Table, light grey laminate, black base	1.114

JH70 MUST BE ORDERED TOGETHER WITH SOFA AND IS NOT INTERCHANGEABLE

OPTIONS

DESCRIPTION	PRICE
PU01, Power unit for sofa, black (1 pcs., available in select markets only)	470

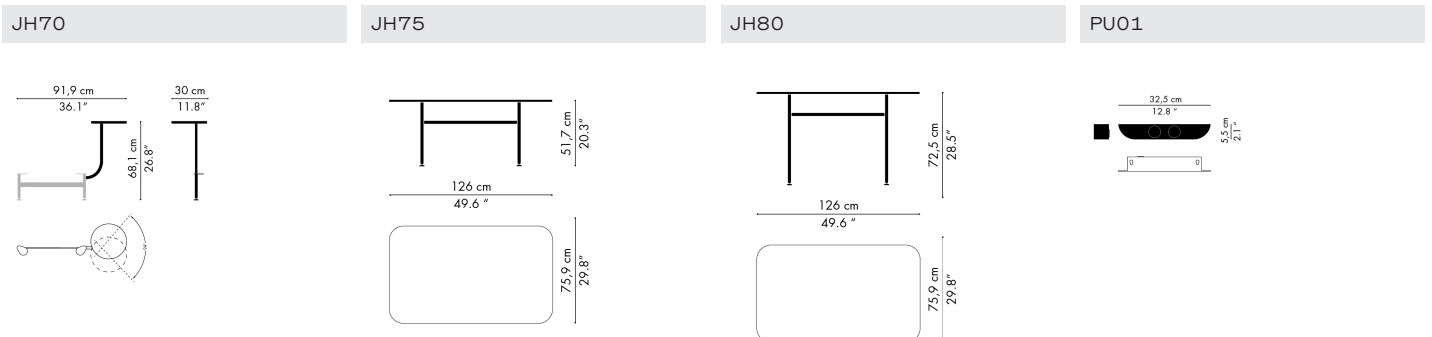
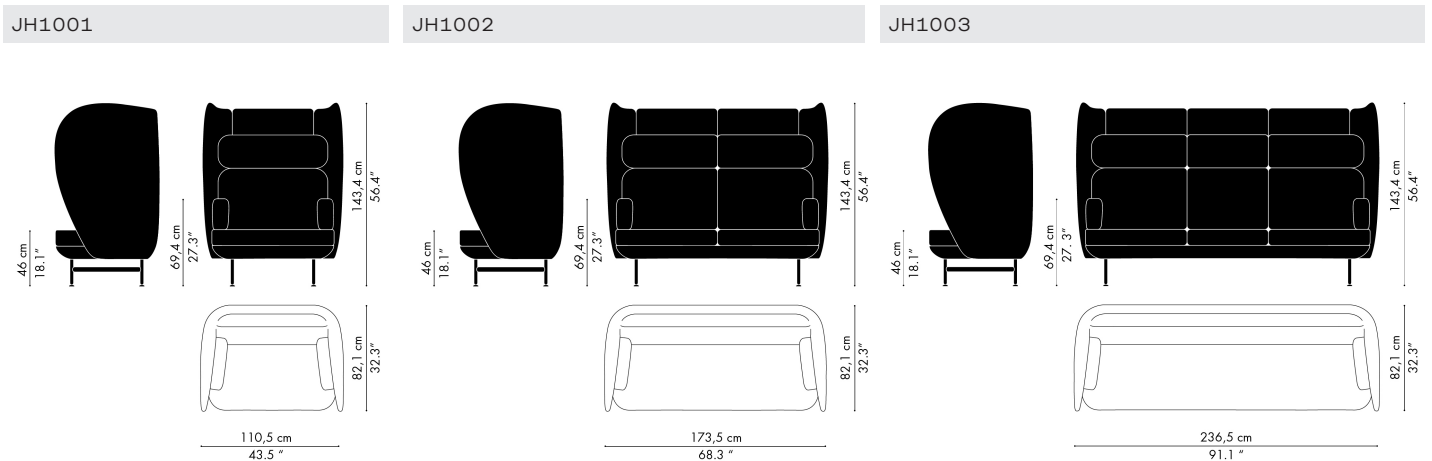



SUPERELLIPSE™
PIET HEIN/BRUNO MATHSSON 1968

11.2023

The Superellipse™ tables are available in various sizes and with a tabletop made of either Fenix laminate or clear lacquered walnut veneer. While laminate versions come with an aluminium edge, the walnut veneer versions come with a natural wooden edge. The table's iconic span legs are available either in chromed or powder coated steel.

DINING TABLES (HEIGHT 72 CM)

MODEL	DESCRIPTION	FENIX LAMINATE	CLEAR LACQUERED WALNUT	H/L/W
B611	Table, span legs, detachable	1.817	2.643	72/135/90
B612	Table, span legs, detachable	1.982	2.809	72/150/100
B616	Table, span legs, detachable	2.147	3.139	72/170/100
B613	Table, span legs, detachable	2.313	3.470	72/180/120
B614	Table, span legs, detachable	3.057	4.544	72/240/120
B617	Table, span legs, detachable	4.709	7.106	72/300/130

OPTIONS

DESCRIPTION

PRICE

Span legs, table height 52 cm (B2), 70 cm (B4) or 74 cm (B8)

98

FENIX LAMINATE COLOURS - SEE THE SURFACE SELECTION
 WHITE, GREY, BLACK, BROWN OTTAWA, GREY BROMO, GREY EFESO

SPAN LEGS COLOURS
 SILVER GREY, WARM GRAPHITE, BROWN BRONZE, BLACK, WHITE, NINE GREY, CHROME

B611

90 X 135 CM | 76 CM |

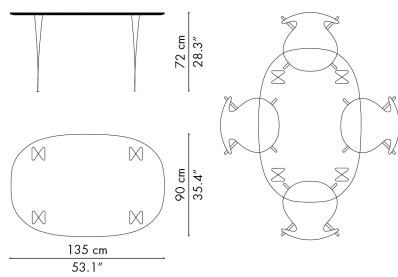

B612

100 X 150 CM | 92 CM |

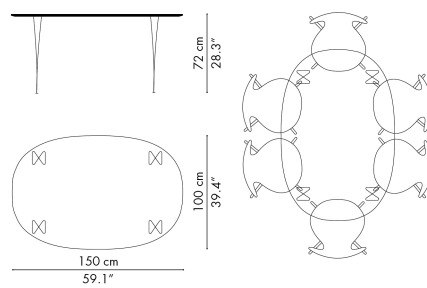

B616

100 X 170 CM | 99 CM |

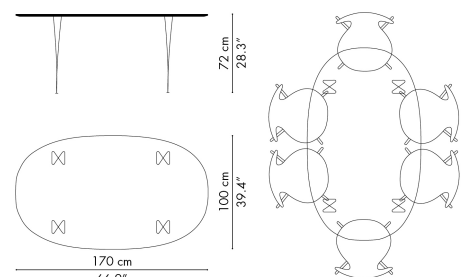

B613

120 X 180 CM | 99 CM |

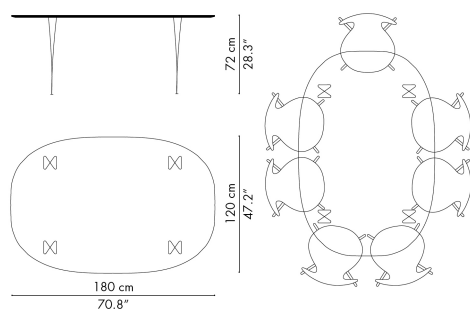

B614

120 X 240 CM | 144 CM |

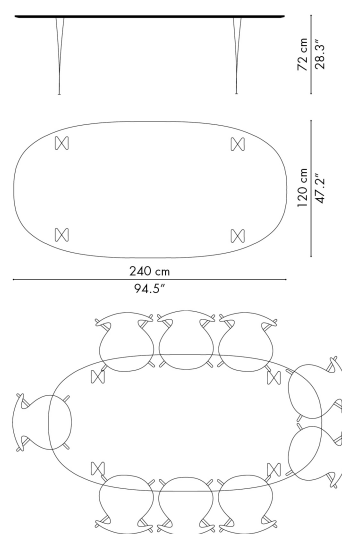

B617

130 X 300 CM | 187 CM |

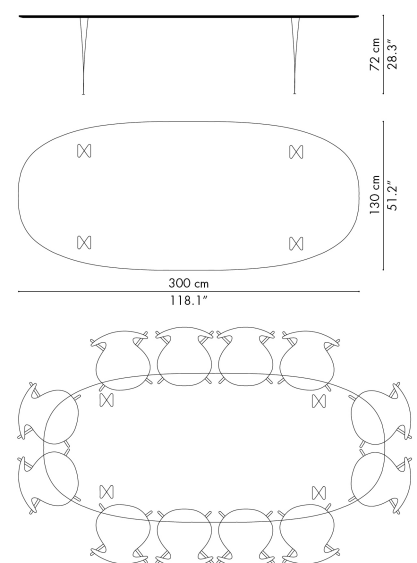

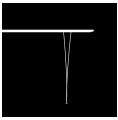

EXTENSION TABLES (HEIGHT 72 CM)

MODEL	DESCRIPTION	FENIX LAMINATE	CLEAR LACQUERED WALNUT	H/L/W
B620	Table, span legs, detachable	4.296	6.776	72/170(270)/100
B619	Table, span legs, detachable	4.544	7.519	72/180(300)/120

OPTIONS

DESCRIPTION	PRICE
Span legs, table height 52 cm (B2), 70 cm (B4) or 74 cm (B8)	98

FENIX LAMINATE COLOURS - SEE THE SURFACE SELECTION
WHITE, GREY, BLACK, BROWN OTTAWA, GREY BROMO, GREY EFESO

SPAN LEGS COLOURS
SILVER GREY, WARM GRAPHITE, BROWN BRONZE, BLACK, WHITE, NINE GREY, CHROME

B620

100 X 170/270 CM

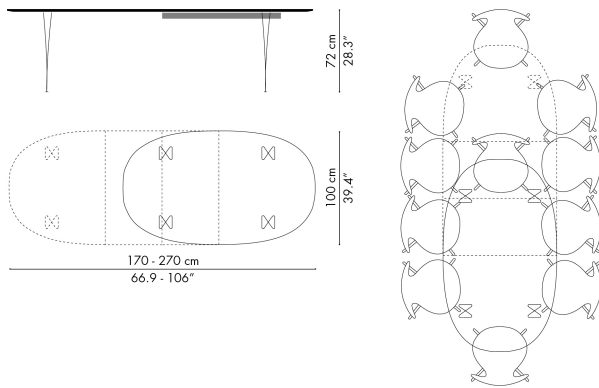

B619

120 X 180/300 CM

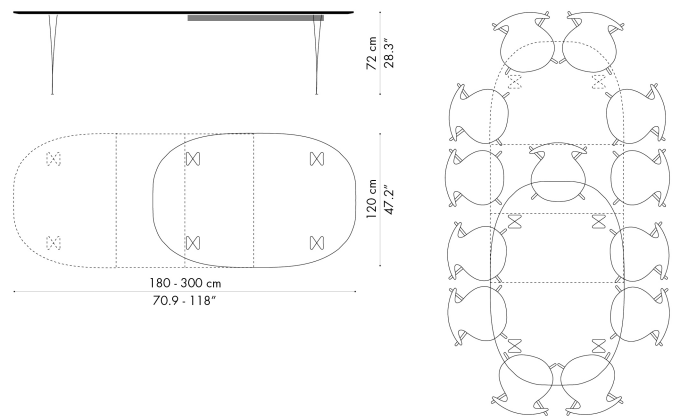

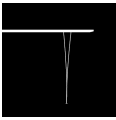

RECTANGULAR
PIET HEIN/BRUNO MATHSSON/ARNE JACOBSEN 1968

11.2023

The Rectangular tables are available in two sizes and with a tabletop made of either Fenix laminate or clear lacquered walnut veneer. While laminate versions come with an aluminium edge, the walnut veneer versions come with a natural wooden edge. The table's iconic span legs are available either in chromed or powder coated steel.

DINING TABLES (HEIGHT 72 CM)

MODEL	DESCRIPTION	FENIX LAMINATE	CLEAR LACQUERED WALNUT	H/L/W
B637	Table, span legs, detachable	1.817	2.726	72/140/80
B638	Table, span legs, detachable	2.065	2.891	72/160/80

OPTIONS

DESCRIPTION	PRICE
Span legs, table height 52 cm (B2), 70 cm (B4) or 74 cm (B8)	98

FENIX LAMINATE COLOURS - SEE THE SURFACE SELECTION
 WHITE, GREY, BLACK, BROWN OTTAWA, GREY BROMO, GREY EFESO

SPAN LEGS COLOURS
 SILVER GREY, WARM GRAPHITE, BROWN BRONZE, BLACK, WHITE, NINE GREY, CHROME

B637

80 X 140 CM | 112 CM |

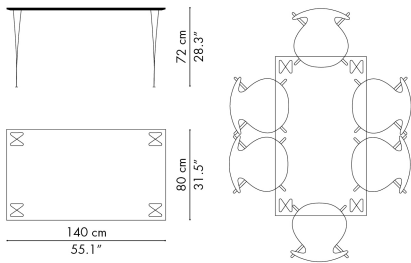

B638

80 X 160 CM | 121 CM |

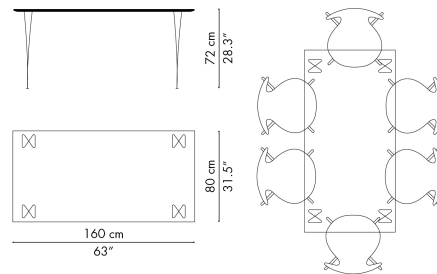



EGG™ TABLE
ARNE JACOBSEN 1952

11.2023

The Egg™ Table is crafted with an FSC-certified clear lacquered walnut veneer tabletop. Resting on three chromed steel legs, the elliptical design is equally purposeful as a kitchen or dining table in smaller spaces as it is in a home office. It fits seamlessly into any setting.

MODEL	DESCRIPTION	CLEAR LACQUERED WALNUT	H/L/W
3603	Table, 3 legs, chromed tubular steel	1.982	74/115/84

3603 H72

3603 H74

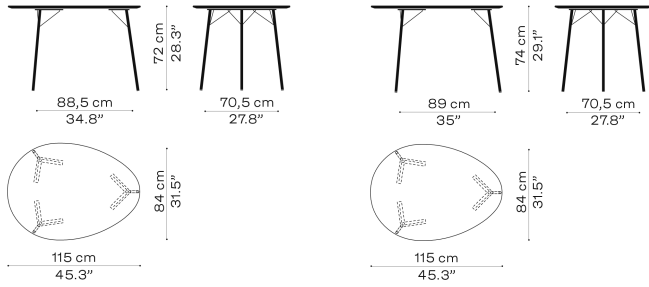



FH3605™
ARNE JACOBSEN 1955

11.2023

The FH3605™ table or "Writing Desk" is a rectangular table available in either black coloured ash or clear lacquered walnut veneer. The base consists of four legs made of chromed or black powder coated steel with a solid wood detail matching the tabletop. FH3605™ is available with one document drawer in solid wood in walnut or black coloured ash. The drawer can be installed in either left or right side.

MODEL	DESCRIPTION	BLACK COLOURED ASH	CLEAR LACQUERED WALNUT	H/L/W
3605DD	Desk with drawer, veneer table top, chromed or powder coated steel, table height 72 cm or 74 cm	2.726	2.891	72/152/80
3605DE	Desk, veneer table top, chromed or powder coated steel, table height 72 cm or 74 cm	2.230	2.478	72/152/80
3605DR	Drawer, solid wood	486	544	8/52/30

FH3605DD

FH3605DE

FH3605DR

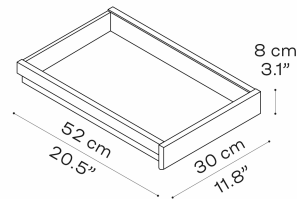
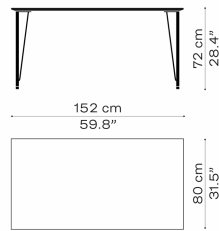
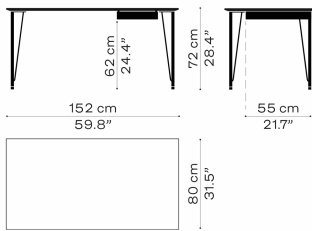

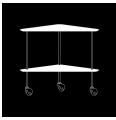

AJ TROLLEY™
ARNE JACOBSEN 1955/2020

11.2023

The AJ Trolley™ is a small table with triangular table tops with a black coloured ash veneer finish. While the table tops are made of veneered medium-density fiberboard, the frame is made of brushed stainless steel and comes with castors with a metal housing.

MODEL	DESCRIPTION	PRICE
840410	Trolley, black coloured ash, brushed stainless steel	676

840410

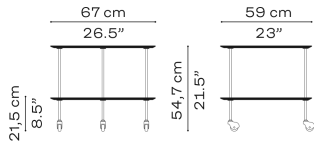



STUB™
METTE SCHELDE 2020

11.2023

The Stub™ is a side table with a tempered glass tabletop moulded around a wooden base. The base is made of pressure moulded veneer base and comes in three different finishes: Clear lacquered oak, clear lacquered ash or black coloured ash. The integrated, tempered glass tabletop is cut for a smooth transition from glass to wood on the table surface.

MODEL	DESCRIPTION	VENEER	H/Ø
MS11	Side table, clear lacquered oak, clear lacquered ash or black coloured ash, glass	569	44,5/49

MS11

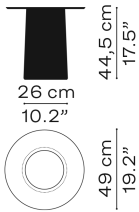



The Essay™ table comes in three sizes and is made of solid oak which is treated with either natural or white pigmented oil. The Essay™ extension leaf comes in two widths and is available in black Fenix laminate.

MODEL	DESCRIPTION	NATURAL OAK	WHITE PIGMENTED OAK	H/L/W
CM21	Table, solid oak	4.048	4.048	72/218/95
CM27	Table, solid oak	5.371	5.371	72/272/100
CM31	Table, solid oak	6.776	6.776	72/317/100

EXTENSION LEAF

MODEL	DESCRIPTION	BLACK FENIX LAMINATE	L/W
CM95	Extension leaf, black laminate tabletop	619	48/95
CM100	Extension leaf, black laminate tabletop	619	48/100

CM21

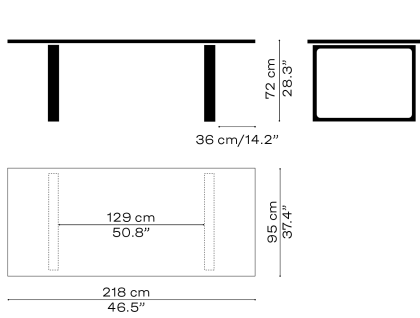

95 X 218 CM | 129 CM |

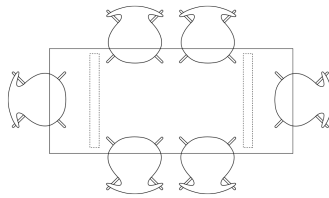

CM21 + 2/CM95

95 X 218/314 CM | 129 CM |

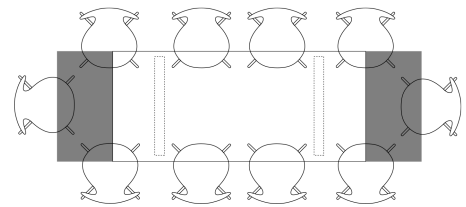

CM27

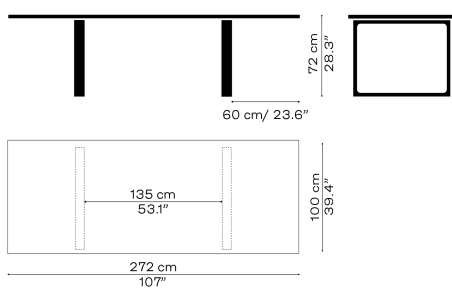

100 X 272 CM | 135 CM |

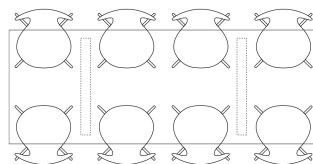

CM27 + 2/CM100

100 X 272/368 CM | 135 CM |

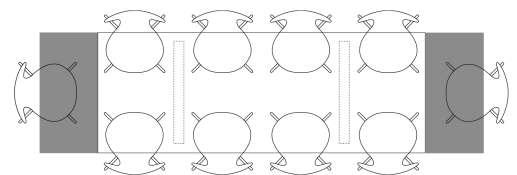



CM31

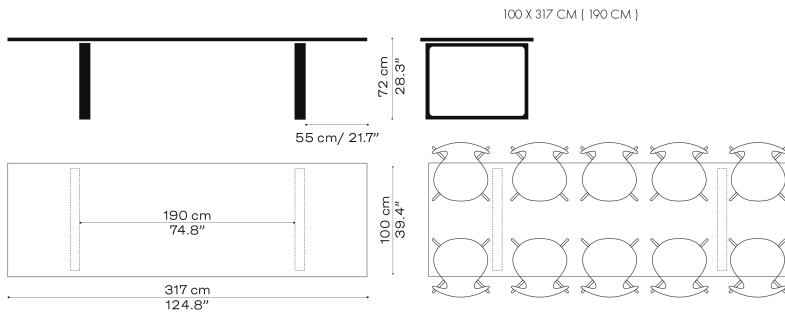

CM31 + 2/CM100

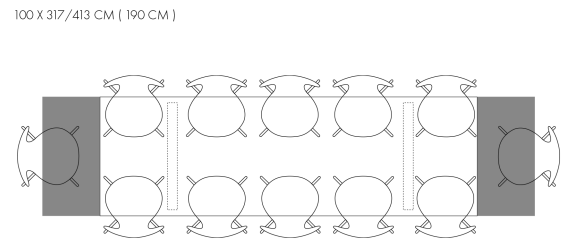

CM95

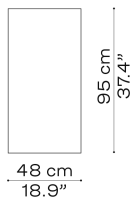

CM100

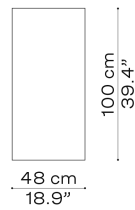



The Analog™ table comes in three sizes with a tabletop in either white laminate (Pfleiderer), clear lacquered oak or walnut veneer. The base consists of four legs made of solid wood, which can be configured in either black coloured oak, clear lacquered oak or walnut. The legs are attached to the table top with a 'trumpet' in either white or black powder coated aluminium. The underside of the table top is coloured in colours matching the trumpet.

MODEL	DESCRIPTION	LAMINATE (PFLEIDERER)	CLEAR LACQUERED VENEER	H/L/W
JH43	Table, laminate or veneer top, legs in solid wood	1.528	1.817	72/130/105
JH63	Table, laminate or veneer top, legs in solid wood	1.817	2.230	72/185/105
JH83	Table, laminate or veneer top, legs in solid wood	2.147	2.809	72/245/105

TABLE WITH TABLETOP IN WHITE LAMINATE OR CLEAR LACQUERED OAK VENEER IS AVAILABLE WITH LEGS IN CLEAR LACQUERED OAK AND WHITE TRUMPET. TABLE WITH TABLETOP IN CLEAR LACQUERED WALNUT VENEER IS AVAILABLE WITH LEGS IN BLACK COLOURED OAK OR CLEAR LACQUERED WALNUT, BOTH WITH BLACK TRUMPET.

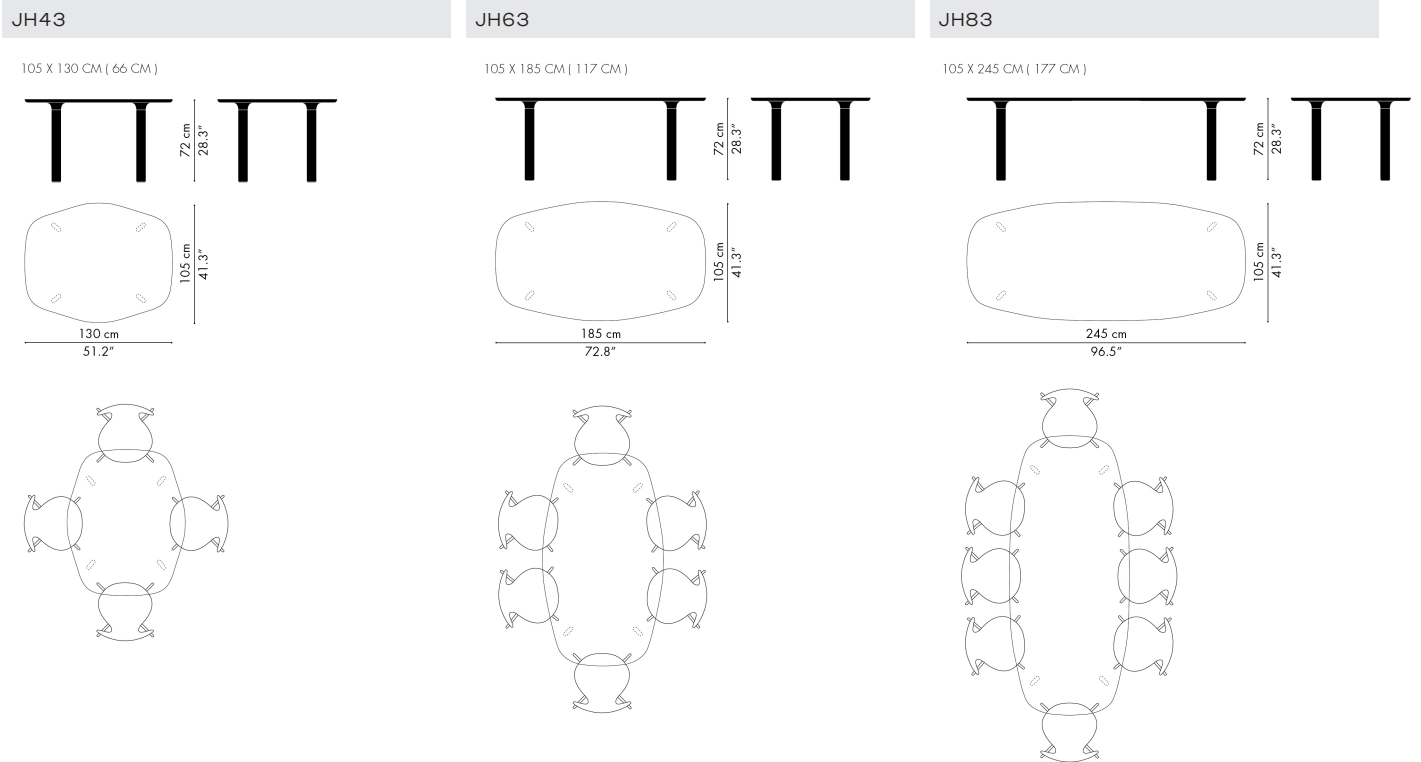



The Join™ coffee table series comes in three shapes. The table top is made of solid oak and configurable in two finishes: Oak with clear lacquer or black coloured oak. The base consists of four legs in black powder coated steel.

MODEL	DESCRIPTION	OAK, BLACK COLOURED OAK	H/L/W
FH21	Coffee table, oval, solid wood, powder coated steel legs	552	37/76/47
FH41	Coffee table, round, solid wood, powder coated steel legs	709	37/∅80
FH61	Coffee table, oval, solid wood, powder coated steel legs	784	37/130/50

FH21

47 X 76 CM

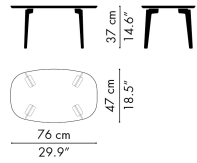

FH41

∅80 X 37 CM

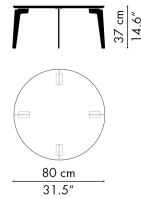

FH61

50 X 130 CM

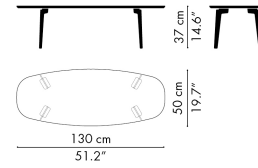



PLURALIS™
KASPER SALTO 2016

11.2023

The Pluralis™ table comes in a wide range of sizes and with five different table tops: Mauve Brown linoleum, Lava Grey or white laminate (Polyrey) and clear lacquered oak or walnut veneer. The base is made of die-cast aluminium and comes with a polished or powder coated finish. The base is mounted with adjustable glides. Electrification and cable management are optionally available.*

MODEL	DESCRIPTION	LAMINATE (POLYREY)	LINOLEUM	ENEER: OAK	ENEER: WALNUT
KS420	Table, polished or powder coated aluminium, 80 cm x 160 cm	1.652	1.982	2.643	2.643
KS421	Table, polished or powder coated aluminium, 80 cm, 90 cm, or 100 cm x 200 cm	2.065	2.478	3.222	3.304
KS422	Table, polished or powder coated aluminium, 80 cm, 90 cm, 100 cm or 120 cm x 240 cm	2.478	2.974	3.883	3.966
KS423	Table, polished or powder coated aluminium, 90 cm, 100 cm or 120 cm x 320 cm	3.304	3.966	5.205	5.288
KS424	Table, polished or powder coated aluminium, 90 cm, 100 cm or 120 cm x 480 cm	4.957	5.949	7.767	7.933
KS425	Table, polished or powder coated aluminium, 90 cm, 100 cm or 120 cm x 720 cm	7.106	8.676	11.156	11.569

1 OVERHANG

MODEL	DESCRIPTION	LAMINATE (POLYREY)	LINOLEUM	ENEER: OAK	ENEER: WALNUT
KS42001	Table, polished or powder coated aluminium, 80 cm x 185 cm	1.941	2.313	2.974	3.057
KS42101	Table, polished or powder coated aluminium, 80 cm, 90 cm, or 100 cm x 225 cm	2.313	2.809	3.635	3.718
KS42201	Table, polished or powder coated aluminium, 80 cm, 90 cm, 100 cm or 120 cm x 265 cm	2.809	3.304	4.296	4.379
KS42301	Table, polished or powder coated aluminium, 90 cm, 100 cm or 120 cm x 345 cm	3.635	4.296	5.619	5.701
KS42401	Table, polished or powder coated aluminium, 90 cm, 100 cm or 120 cm x 505 cm	5.205	6.280	8.180	16.528
KS42501	Table, polished or powder coated aluminium, 90 cm, 100 cm or 120 cm x 745 cm	7.354	9.090	11.569	11.982

2 OVERHANGS

MODEL	DESCRIPTION	LAMINATE (POLYREY)	LINOLEUM	ENEER: OAK	ENEER: WALNUT
KS42002	Table, polished or powder coated aluminium, 80 cm x 210 cm	2.147	2.561	3.304	3.387
KS42102	Table, polished or powder coated aluminium, 80 cm, 90 cm, or 100 cm x 250 cm	2.561	3.057	3.966	4.048
KS42202	Table, polished or powder coated aluminium, 80 cm, 90 cm, 100 cm or 120 cm x 290 cm	2.974	3.552	4.627	4.709
KS42302	Table, polished or powder coated aluminium, 90 cm, 100 cm or 120 cm x 370 cm	3.800	4.544	5.949	6.032
KS42402	Table, polished or powder coated aluminium, 90 cm, 100 cm or 120 cm x 530 cm	5.453	6.528	8.676	8.676
KS42502	Table, polished or powder coated aluminium, 90 cm, 100 cm or 120 cm x 770 cm	7.602	9.090	11.982	11.982

LAMINATE COLOURS: WHITE, LAVA GREY

LINOLEUM COLOURS: MAUVE BROWN

CLEAR LACQUERED VENEER: Oak, Walnut

BASE COLOURS: WARM GRAPHITE, BROWN BRONZE, BLACK, POLISHED ALUMINIUM

ELECTRIFICATION

DESCRIPTION	PRICE
Power Frame, including 4-module power strip, 28,4 cm x 7,3 cm, stainless steel, 3 m power infeed cable	470
Top Frame including 4-module power strip, 30,3 cm x 9,4 cm, with lid matching the tabletop, 3 m power infeed cable	1.445
Rectangular cable well, L 32,5 cm x W 13 cm, incl. cut out, aluminium (1 pcs.)	214
Round cable well, Ø 8,8 cm, incl. cut out, aluminium (1 pcs)	214
Cable tray, 65 cm, black powder coated steel	180
Cable hose, 78-125 cm, black or silver	180
Cut out for customer's own electrification solution	

*POWER FRAME AND TOP FRAME AVAILABLE IN EU, GB, CH, KR, JP, AND CN



KS422

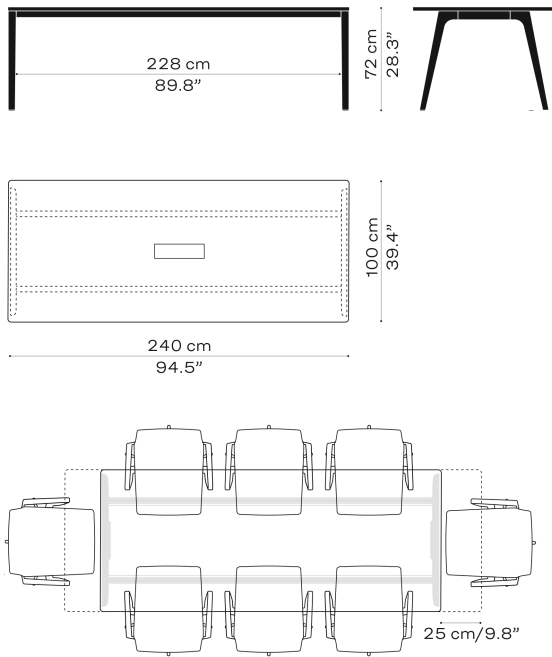

KS423

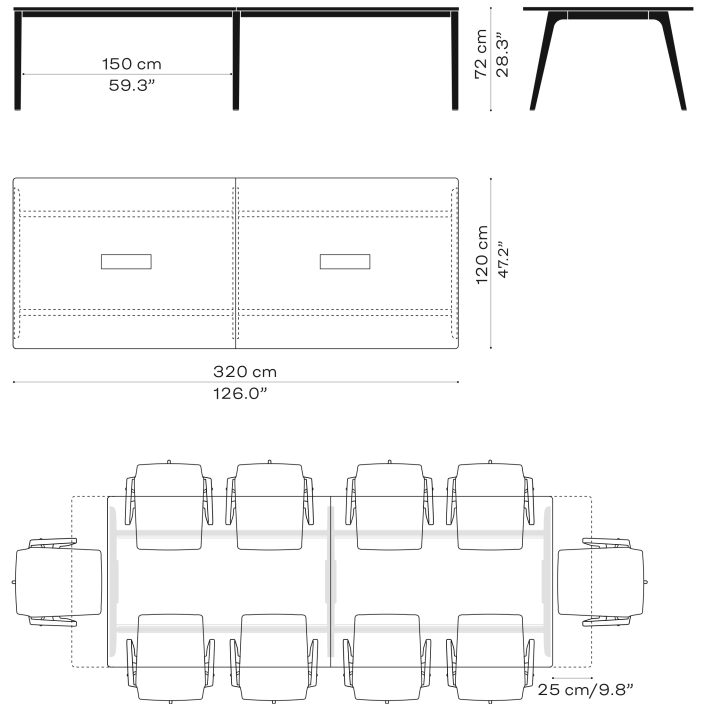

KS420

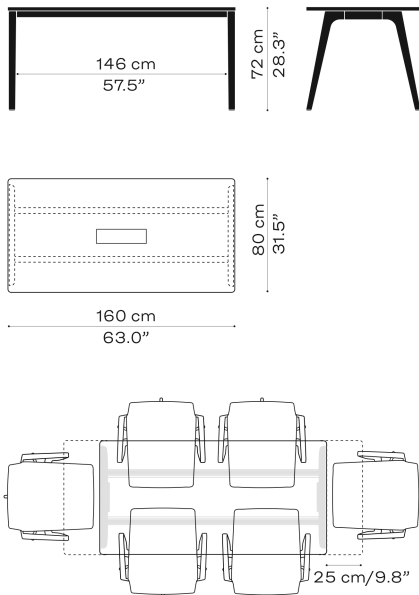

KS421

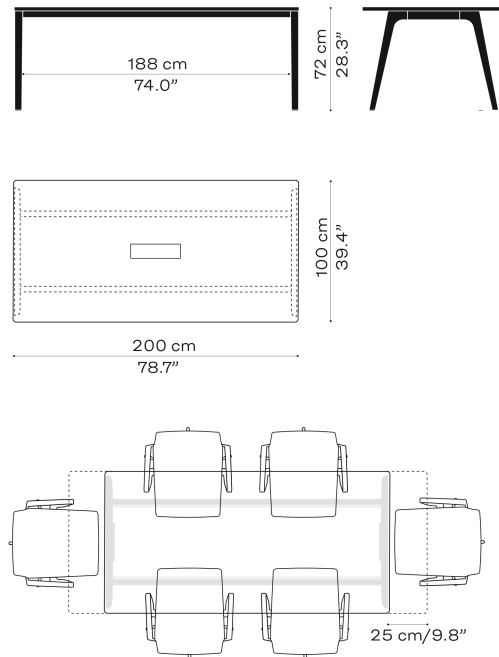



KS424

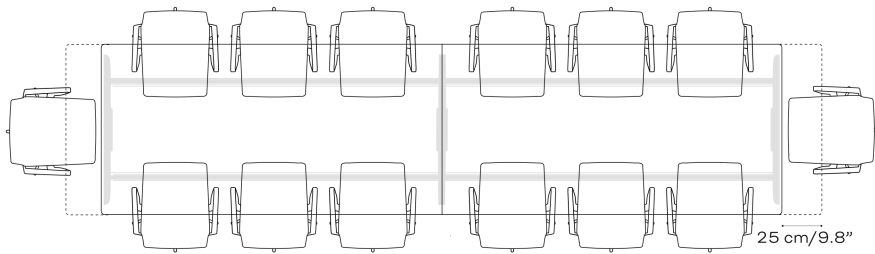
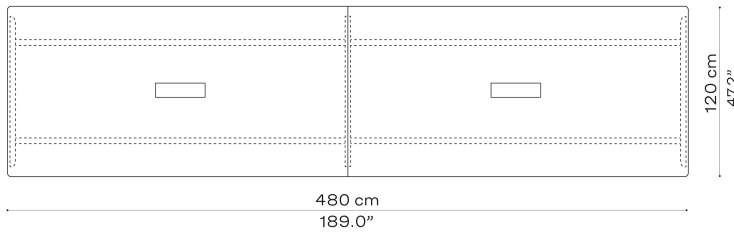

KS425

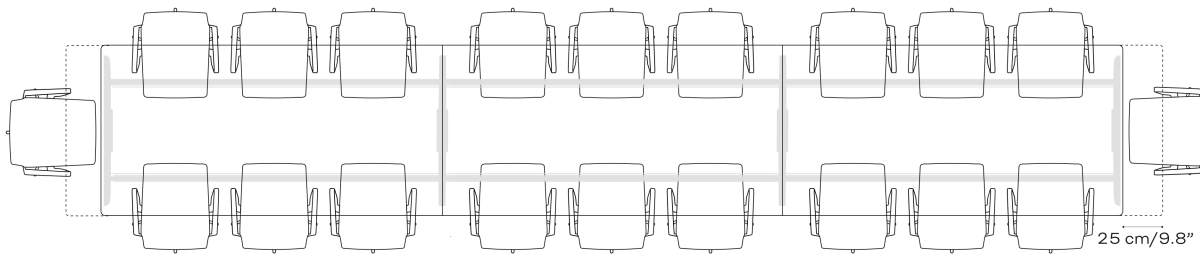
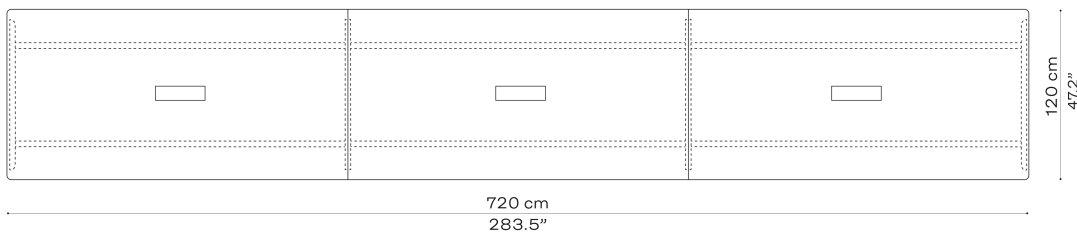

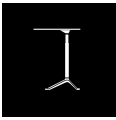

LITTLE FRIEND™
KASPER SALTO 2005

11.2023

The Little Friend™ table is available as a height-adjustable or fixed height version. The table top comes in compact laminate with four different finishes: Black, white, oak or walnut. The base is made of a die-cast aluminium foot that is connected to a steel column. The configurable base finishes in chrome column/polished foot, powder coated black or white depending on the table top.

MODEL	DESCRIPTION	BLACK, WHITE	OAK, WALNUT	H/Ø
KS11	Table, height adjustable, chromed/polished or powder coated base	1.156	1.280	50 - 73/45
KS12	Table, fixed height, chromed/polished or powder coated base	776	866	60/45

TABLE WITH A TABLETOP IN WHITE LAMINATE IS AVAILABLE WITH A WHITE OR CHROMED/POLISHED BASE.
TABLE WITH A TABLETOP IN BLACK LAMINATE, OAK OR WALNUT IS AVAILABLE WITH A BLACK OR CHROMED/POLISHED BASE.

KS11

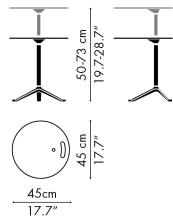

KS12

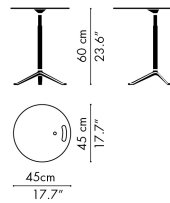



PLANNER™ TABLE SERIES
PAUL MCCOBB 1952/2018

11.2023

The Planner™ Table Series consists of coffee tables in six different sizes. The honed marble tabletop is available in two colours: Cream or Charcoal. The base consists of a frame in black powder coated steel.

MODEL	DESCRIPTION	MARBLE	H/L/W
MC300	Circular coffee table, marble top, powder coated base	1.404	40/80/80
MC310	Rectangular coffee table, marble top, powder coated steel base	1.114	40/75/45
MC320	Square coffee table, marble top, powder coated steel base	1.404	40/80/80
MC330	Square coffee table, marble top, powder coated steel base	990	40/45/45
MC340	Square coffee table, marble top, powder coated steel base	2.147	40/100/100
MC350	Rectangular coffee table, marble top, powder coated steel base	1.941	40/130/70

MARBLE COLOURS - SEE THE SURFACE SELECTION
 CREAM, CHARCOAL

MC300

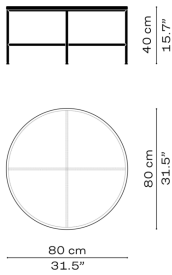

MC310

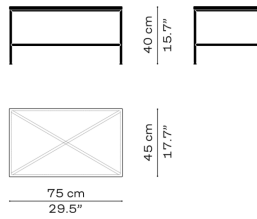

MC320

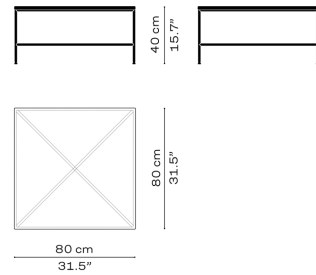

MC330

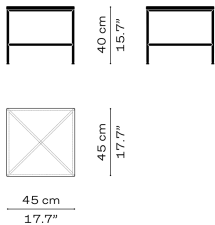

MC340

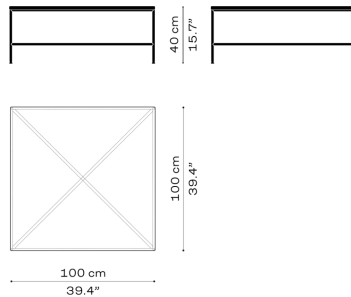

MC350

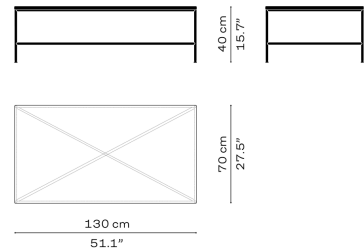

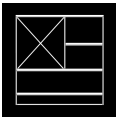

The Planner™ Shelving Series comes in three sizes with shelves in clear lacquered oak veneer and a black powder coated steel frame.

MODEL	DESCRIPTION	CLEAR LACQUERED OAK	H/L/W
MC500	Shelving, small, oak veneer, powder coated steel frame	1.238	84,4/120,7/38,1
MC510	Shelving, medium, oak veneer, powder coated steel frame	1.528	123,2/120,7/38,1
MC520	Shelving, large, oak veneer, powder coated steel frame	1.817	165/120,7/38,1

MC500

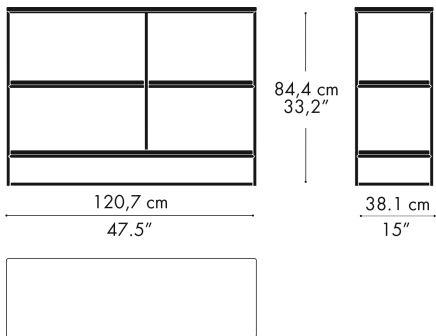

MC510

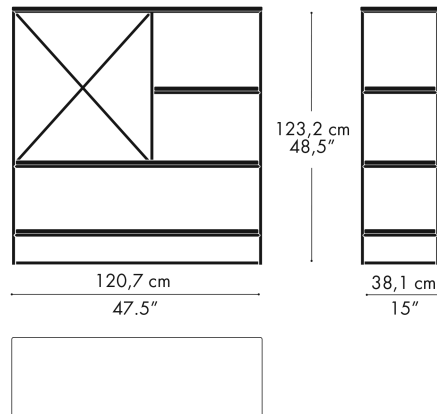

MC520

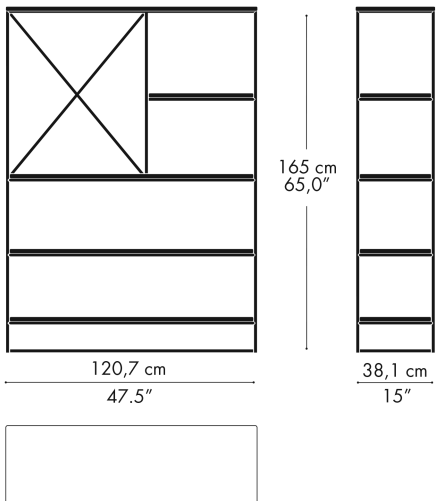

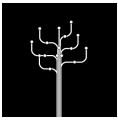

COAT TREE™ / COAT TREE™ WALL
SIDSE WERNER 1971/2019

11.2023

The Coat Tree™ has a free standing and wall mounted variant consisting of eight or four bent steel tubes with round moulded plastic knobs.

MODEL	DESCRIPTION	PRICE
840332	Coat Tree, Chrome / Black knobs	1.114
840330	Coat Hanger, Light Grey / Grey knobs	321
840331	Coat Hanger, Dark Blue / Black knobs	321

840332

840330/840331

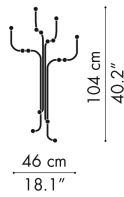
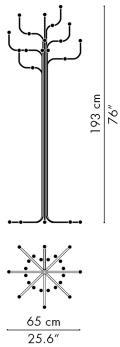



A selection of spare parts for chairs, lounge furniture and tables. Items are sold in colli unless stated otherwise.

CHAIRS

DESCRIPTION	PRICE
Glides for Ant™, Series 7™, Grand Prix™ and Lily™, Black. 1 colli (24 pcs)	79
Glides w/felt for Ant™, Series 7™, Grand Prix™ and Lily™, Black. 1 colli (24 pcs)	79
Glides for Grand Prix™ (4130) wooden base. 1 colli (24 pcs)	79
Glides w/felt for Grand Prix™ (4130), wooden base. 1 colli (24 pcs)	79
Hard castor for soft floors with alu cap for Series 7™, no brake	15
Soft castor for hard floors with alu cap for Series 7™, no brake	15
Hard castor for soft floors with alu cap and tap for Series 7™ produced before 2003, no brake	15
Soft castor for hard floors with alu cap and tap for Series 7™ produced before 2003, no brake	15
Hard castor for soft floors with alu cap for Oxford™, no brake	15
Soft castor for hard floors with alu cap for Oxford, no brake	15
Spacer for Ant™, Series 7™, Grand Prix™, Lily™, High Dot™ & Dot™, Black or Grey rubber. 1 colli (24 pcs)	79
Cover for Ant™, Series 7™, Grand Prix™, Lily™ & Dot™ (4-legs), Black or Grey plastic. 1 colli (6 pcs)	69
Cover for Ant™ & High Dot™ (3-legs), Black or Grey plastic. 1 colli (6 pcs)	69
Chair base 4 legs, seat height 43 cm, 46 cm or 48 cm, for Ant™, Series 7™ & Grand Prix™, chromed or powder coated steel	205

FERRULE / FERRULE W. FELT

SPACER

COVER



CHAIR BASE

CASTOR (SERIES 7™)

CASTOR (OXFORD™)



LOUNGE & SOFAS

DESCRIPTION	PRICE
Glides for the Egg™, Swan™ and Swan sofa™, moulded Black polyamide. 1 colli (4 pcs)	13
Glides with felt for the Egg™, Swan™ and Swan sofa™, moulded Black polyamide. 1 colli (4 pcs)	13
Adjustment handle for the Egg™, polished stainless steel	131

GLIDE

GLIDE W. FELT

ADJUSTMENT HANDLE





TABLES

DESCRIPTION	PRICE
Glide for span legs, transparent plastic. 1 colli (4 pcs)	29
Span legs (set of 4 pcs.), table height 70 cm (B4), without mounting plate, chromed or powder coated steel	734
Span legs (set of 4 pcs.), table height 72 cm (B6), without mounting plate, chromed or powder coated steel	734
Pedestal base 4-star, table height 47 cm (A2), satin brushed aluminium, satin chromed pedestal	784
Pedestal base 4-star, table height 72 cm (A6), satin brushed aluminium, satin chromed pedestal	784
Pedestal base, 6-star, table height 72 cm (A8), satin brushed aluminium, satin chromed pedestal	1.652
Pedestal base, 4-star, table height 108 cm (A9), satin brushed aluminium, satin chromed pedestal	123
Laminate cleaner for White laminate. 1 colli (6 pcs)	639
Cleaning sponges for laminate tabletops. 1 colli (10 pcs)	115
Essay™ oil kit, natural (1 pcs)	69
Essay™ oil kit, White pigmented (1 pcs)	69
Stonewash for marble tables (1 pcs)	36

SPAN LEGS	A2	A6	A8	A9
-----------	----	----	----	----

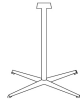

GLIDER SPAN LEGS	LAMINATE CLEANER	ESSAY OIL KIT	STONE WASH	CLEANING SPONGES
------------------	------------------	---------------	------------	------------------



SURFACE SELECTION

SURFACE SELECTION

INVENTORY

- 73 • Textiles
- 78 • Leather
- 81 • Seat cushions
- 82 • Wood
- 86 • Plastic
- 87 • Laminate
 - Linoleum
 - Marble
 - Glass
- 88 • Powder coated metal
- 89 • Metal
 - Paper cord

SURFACE SELECTION

TEXTILES

Please note that not all textiles are suitable on all the furniture. On each individual model the standard textile options are listed. Some textiles are only available in a selection of colours.

CUSTOMER'S OWN MATERIAL (COM)

Customers can supply their own textiles. Textile requirements, based on standard textile 130 cm wide, can be given on inquiry. We reserve the right to reject textiles that we find unsuitable for upholstery.

CATEGORY 1

BELFAST (VELVET)

MATERIALS: 100% COTTON
DURABILITY: 50.000 MARTINDALE
COLOURS: 10

CANVAS

MATERIALS: 90% NEW WOOL (WORSTED), 10% NYLON
DURABILITY: 100.000 MARTINDALE
AVAILABLE IN ALL COLOURS

CAPTURE

MATERIALS: 85% WOOL, 15% POLYAMIDE
DURABILITY: 200.000 MARTINDALE
AVAILABLE IN ALL COLOURS

DIABLO

MATERIALS: 54% VISCOSE, 46% COTTON
DURABILITY: >30.000 MARTINDALE
AVAILABLE IN ALL COLOURS

FAME

MATERIALS: 95% WOOL, 5% POLYAMID
DURABILITY: 200.000 MARTINDALE
AVAILABLE IN ALL COLOURS

HUE

MATERIALS: 70% VISCOSE, 30% LINEN
DURABILITY: 36.000 MARTINDALE
AVAILABLE IN ALL COLOURS

LINARA

MATERIALS: 63% COTTON, 37% LINEN
DURABILITY: 65.000 MARTINDALE
COLOURS: 6

MESSENGER

MATERIALS: 78% POST INDUSTRIAL RECYCLED,
15% POLYESTER, 7% NYLON
DURABILITY: 65.000 MARTINDALE
AVAILABLE IN ALL COLOURS

MOOD

MATERIALS: 92% WOOL, 8% POLYAMID
DURABILITY: 100.000 MARTINDALE
AVAILABLE IN ALL COLOURS

REMIX

MATERIALS: 90% NEW WOOL (WORSTED) 10% NYLON
DURABILITY: 100.000 MARTINDALE
AVAILABLE IN ALL COLOURS

RIME

MATERIALS: 90% NEW WOOL (WORSTED), 10% NYLON
DURABILITY: 100.000 MARTINDALE
AVAILABLE IN ALL COLOURS

TONUS

MATERIALS: 90% NEW WOOL, 10% HELANCA
DURABILITY: 100.000 MARTINDALE
AVAILABLE IN ALL COLOURS

CATEGORY 2

CLAY

MATERIALS: 76% LINEN, 21% COTTON,
3% POLYESTER
DURABILITY: 45.000 MARTINDALE
COLOURS: 6

DIVINA

MATERIALS: 100% NEW WOOL
DURABILITY: 45.000 MARTINDALE
AVAILABLE IN ALL COLOURS

DIVINA MD

MATERIALS: 100% NEW WOOL
DURABILITY: 45.000 MARTINDALE
AVAILABLE IN ALL COLOURS

DIVINA MELANGE

MATERIALS: 100% NEW WOOL
DURABILITY: 45.000 MARTINDALE
AVAILABLE IN ALL COLOURS

FIORD

MATERIALS: 92% NEW WOOL (WORSTED), 8% NYLON
DURABILITY: 60.000 MARTINDALE
AVAILABLE IN ALL COLOURS

HALLINGDAL

MATERIALS: 70% NEW WOOL, 30% VISCOSE
DURABILITY: 100.000 MARTINDALE
AVAILABLE IN ALL COLOURS

HARALD (VELVET)

MATERIALS: 100% COTTON
DURABILITY: 100.000 MARTINDALE
AVAILABLE IN ALL COLOURS

KARAKORUM

MATERIALS: 42% WOOL, 33% VISCOSE, 24% COTTON,
1% POLYAMIDE
DURABILITY: 40.000 MARTINDALE
AVAILABLE IN ALL COLOURS

MERIT

MATERIALS: 76% POST CONSUMER RECYCLED,
24% POLYESTER
DURABILITY: 85.000 MARTINDALE
AVAILABLE IN ALL COLOURS

MOSS

MATERIALS: 52% COTTON, 22% VISCOSE,
14% POLYACRYLIC, 6% LINEN, 3% POLYESTER,
3% NYLON
DURABILITY: 50.000 MARTINDALE
COLOURS: 6

NABIS

MATERIALS: 48% COTTON, 30% VISCOSE,
22% POLYESTER
DURABILITY: 40.000 MARTINDALE
COLOURS: 2

RAAS

MATERIALS: 92% NEW WOOL (WORSTED), 8% NYLON
DURABILITY: 100.000 MARTINDALE
AVAILABLE IN ALL COLOURS

RE-WOOL

MATERIALS: 45% RECYCLED WOOL, 45% NEW WOOL
(WORSTED), 10% NYLON
DURABILITY: 100.000 MARTINDALE
AVAILABLE IN ALL COLOURS

SAFIRE

MATERIALS: 43% VISCOSE, 17% POLYACRYL,
15% NEW WOOL, 9% COTTON, 8% LINEN, 8% POLYESTER
DURABILITY: 40.000 MARTINDALE
AVAILABLE IN ALL COLOURS

STEELCUT

MATERIALS: 90% NEW WOOL (WORSTED) 10% NYLON
DURABILITY: 100.000 MARTINDALE
AVAILABLE IN ALL COLOURS

STEELCUT TRIO

MATERIALS: 90% NEW WOOL (WORSTED) 10% NYLON
DURABILITY: 100.000 MARTINDALE
AVAILABLE IN ALL COLOURS

SUNNIVA

MATERIALS: 58% NEW WOOL, 25% VISCOSE, 8% LINEN,
5% NYLON, 4% POLYESTER
DURABILITY: 50.000 MARTINDALE
AVAILABLE IN ALL COLOURS

TWILL WEAVE

MATERIALS: 90% NEW WOOL (WORSTED), 10% NYLON
DURABILITY: 60.000 MARTINDALE
AVAILABLE IN ALL COLOURS

VANIR

MATERIALS: 92% NEW WOOL (WORSTED), 8% NYLON
DURABILITY: 100.000 MARTINDALE
COLOURS: 12

VIDAR

MATERIALS: 94% NEW WOOL, 6% NYLON
DURABILITY: 100.000 MARTINDALE
AVAILABLE IN ALL COLOURS

CATEGORY 3

COMFORT

MATERIALS: 88% POLYESTER, 12% NYLON
DURABILITY: 150.000 MARTINDALE
AVAILABLE IN ALL COLOURS

GENTLE (VELVET)

MATERIALS: 60% WOOL, 20% POLYAMIDE,
20% POLYESTER
DURABILITY: 90.000 MARTINDALE
AVAILABLE IN ALL COLOURS

SONAR

MATERIALS: 59% NEW WOOL, 25% VISCOSE,
9% LINEN, 5% NYLON, 2% POLYESTER
DURABILITY: 20.000 MARTINDALE
AVAILABLE IN ALL COLOURS

CATEGORY 4

ATOM

MATERIALS: 90% NEW WOOL (WORSTED),
8% NYLON, 2% POLYESTER
DURABILITY: 65.000 MARTINDALE
COLOURS: 2

RIA

MATERIALS: 84% NEW WOOL (WORSTED),
12% VISCOSE, 4% NYLON
DURABILITY: 50.000 MARTINDALE
AVAILABLE IN ALL COLOURS

MISCELLANEOUS

JUST

MATERIALS: 98% POST-CONSUMER RECYCLED
POLYESTER / 2% POLYESTER
DURABILITY: 70.000 MARTINDALE

SALSA

MATERIALS: 100% POLYESTER
DURABILITY: 200.000 MARTINDALE

SURFACE SELECTION

TEXTILES

	ATOM	BELFAST	CANVAS	CAPTURE	CHRISTIANSHAVN	CLAY	COMFORT	DIABLO	DIVINA	DIVINA MELANGE	DIVINA MD	FAME	FIORD	GENTLE	HALLINGDAL	HARALD	HUE	JUST	KARAKORUM	LINARA	MERIT	MESSENGER	MOOD	MOSS	NABIS	RAAS	REMIX	RE-WOOL	RIA	RIME	SAFIRE	SALSA	SONAR	STEELCUT	STEELCUT TRIO	SUNNIVA	TONUS	TWILL WEAVE	VANIR	VIDAR					
ALPHABET™ SOFA SERIES			●	●	●		●	●	●	●	●	●	●	●	●	●	●		●									●	●						●	●	●	●							
ANT™ FRONT		●	●	●	●		●	●	●	●	●	●	●	●	●	●												●	●								●	●	●	●		●	●		
CHINA CHAIR™																																													
DOT™																														●															
DROP™			●	●	●		●	●	●	●	●	●	●	●	●	●												●	●								●	●	●	●					
DROP™ SEAT CUSHION																																													
EGG™			●	●	●		●	●	●	●	●	●	●	●	●	●												●	●		●						●	●	●	●					
FAVN™ SHELL/BASE				●	●				●	●	●	●	●	●	●	●												●	●							●	●	●	●						
FAVN™ SEAT/BACK			●	●	●			●	●	●	●	●	●	●	●	●												●	●								●	●	●	●					
FAVN™ CUSHIONS			●	●	●			●	●	●	●	●	●	●	●	●												●	●								●	●	●	●					
FRED™		●			●												●	●											●	●															
FRI™	●	●	●	●				●	●	●	●	●	●	●	●	●												●	●		●	●				●	●	●	●					●	
FRI™ FOOTSTOOL	●	●	●	●				●	●	●	●	●	●	●	●	●												●	●		●	●				●	●	●	●					●	
GRAND PRIX™ FRONT			●	●	●		●	●	●	●	●	●	●	●	●	●												●	●							●	●	●	●			●			
GRAND PRIX™ FULL			●	●	●		●	●	●	●	●	●	●	●	●	●												●	●							●	●	●	●			●			
LET™			●		●				●	●	●	●	●	●	●	●		●										●	●							●	●	●	●					●	
LILY™			●	●	●		●	●	●	●	●	●	●	●	●	●												●	●							●	●	●	●					●	
LITTLE GIRAFFE™			●	●	●		●	●	●	●	●	●	●	●	●	●												●	●							●	●	●	●						
LITTLE GIRAFFE™ REMOVABLE COVER			●	●	●		●	●	●	●	●	●	●	●	●	●												●	●							●	●	●	●						
LISSONI SOFA™			●	●	●	●	●	●	●	●	●	●	●	●	●	●					●							●	●							●	●	●	●						
LUNE™			●	●	●		●	●	●	●	●	●	●	●	●	●				●								●	●							●	●	●	●						
N01™ SEAT CUSHION																												●	●																
N02™ RECYCLE SEAT CUSHION																			●																										
NAP™ SEAT CUSHION										●																																			
OXFORD™			●	●	●		●	●	●	●	●	●	●	●	●	●												●	●						●	●	●	●						●	
PLENUM™			●	●	●			●	●	●	●	●	●	●	●	●						●						●	●							●	●	●	●						
POT™			●	●	●		●	●	●	●	●	●	●	●	●	●												●	●		●					●	●	●	●						
RO™ SHELL	●		●	●				●	●	●	●	●	●	●	●	●							●				●	●		●	●				●	●	●	●					●		
RO™ CUSHIONS	●	●	●	●			●	●	●	●	●	●	●	●	●	●							●		●	●	●	●	●	●	●	●	●	●	●	●	●	●	●	●	●	●	●	●	●
RO™ FOOTSTOOL	●	●	●	●			●	●	●	●	●	●	●	●	●	●							●		●	●	●	●	●	●	●	●	●	●	●	●	●	●	●	●	●	●	●	●	●
RO™ SOFA SHELL			●	●				●	●	●	●	●	●	●	●	●												●	●							●	●	●	●						
RO™ SOFA CUSHIONS			●	●	●			●	●	●	●	●	●	●	●	●												●	●							●	●	●	●						
SERIES 7™ FRONT		●	●	●	●		●	●	●	●	●	●	●	●	●	●												●	●							●	●	●	●			●			
SERIES 7™ FULL		●	●	●	●		●	●	●	●	●	●	●	●	●	●												●	●							●	●	●	●			●			
SERIES 3300™			●	●	●		●	●	●	●	●	●	●	●	●	●												●	●							●	●	●	●						
SWAN™			●	●			●	●	●	●	●	●	●	●	●	●												●	●		●					●	●	●	●						
SWAN SOFA™			●	●			●	●	●	●	●	●	●	●	●	●												●	●							●	●	●	●						
VIA57™			●	●				●	●	●	●	●	●	●	●	●					●	●						●	●							●	●	●	●						
VICO DUO™ FRONT		●	●	●	●		●	●	●	●	●	●	●	●	●	●												●	●							●	●	●	●						
VICO DUO™ FULL		●	●	●	●		●	●	●	●	●	●	●	●	●	●												●	●							●	●	●	●						
VICO DUO™ SEAT CUSHION																		●																											

SURFACE SELECTION

Colours and materials may vary from the images shown.
Actual colour, gloss level and structure may vary.

TEXTILES

CHRISTIANSHAVN™



Alphabet™ Sofa Series
Ant™
Drop™
Egg™
Favn™
Fred™
Fri™
Grand Prix™
Let™
Lily™
Lissoni Sofa™
Little Giraffe™
Lune™
Oxford™
Plenum™
Pot™
Ro™
Ro™ Sofa
Series 7™
Series 3300™
Swan™
Swan Sofa™
VIA57™
Vico Duo™

MATERIALS: 85% WOOL, 15% POLYAMID
DURABILITY: 200.000 MARTINDALE
LIGHT FASTNESS: 5-7
COLOURS: 26

Christianshavn™ is a timeless, wool mix textile designed by Fritz Hansen. Its 26 contemporary colours offer an immense variety in both unicolour and melange weave. It has superior comfort due to the wool mix and with its high durability and a 200.000 rubs martindale, it is suitable for all upholstered products in the Fritz Hansen collection. The name; Christianshavn leads back to where it all started. The young enterprising cabinet-maker Fritz Hansen started his furniture production company in Christianshavn - a central part of Copenhagen. Christianshavn can be used in private interiors as well as public areas.

DESIGNER SELECTION COLOURS

FRI™

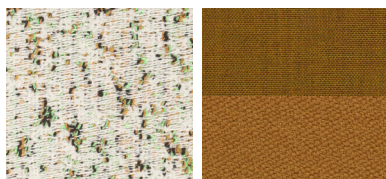

ATOM WHITE
Shell: Atom 0124
Cushions: Atom 0124

BURNT YELLOW
Shell: Remix 422
Cushions: Vidar 472

RO™

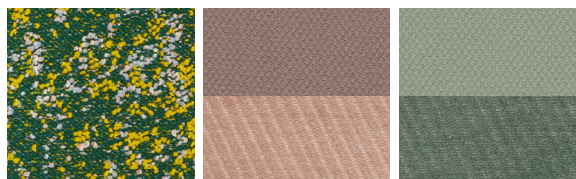

ATOM GREEN
Shell: Atom 0964
Cushions: Atom 0964

PALE ROSE
Shell: Steelcut 605
Cushions: Nabis 0011

MINT GREEN
Shell: Steelcut 935
Cushions: Nabis 0023

SURFACE SELECTION

Colours and materials may vary from the images shown.
Actual colour, gloss level and structure may vary.

SELECTED TEXTILE COLOURS

BELFAST (VELVET)



FOREST GREEN
770660
Ant™
Fred™
Series 7™
Vico Duo™

MISTY ROSE
770593
Ant™
Fred™
Series 7™
Vico Duo™

NIGHT BLACK
772150
Ant™
Fred™
Series 7™
Vico Duo™

DARK PLUM
774232
Ant™
Fred™
Series 7™
Vico Duo™

SEAL GREY
775139
Ant™
Fred™
Series 7™
Vico Duo™

SOFT OCHRE
774926
Ant™
Fred™
Series 7™
Vico Duo™

GREY BROWN
771772
Ant™
Fred™
Series 7™
Vico Duo™



AUTUMN RED
772255
Ant™
Fred™
Series 7™
Vico Duo™

GREY BLUE
772143
Ant™
Fred™
Series 7™
Vico Duo™

MIDNIGHT BLUE
772062
Ant™
Fred™
Series 7™
Vico Duo™

CLAY

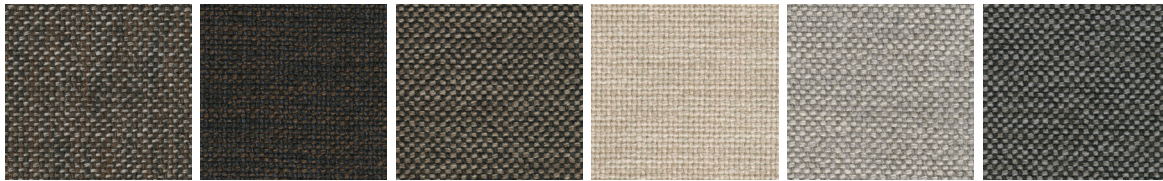

BROWN
0004
Lissoni Sofa™

DARK BROWN
0005
Lissoni Sofa™

DARK SAND
0008
Lissoni Sofa™

BEIGE
0011
Lissoni Sofa™

LIGHT GREY
0012
Lissoni Sofa™

GREY
0013
Lissoni Sofa™

LINARA



BLUEBERRY
2494/198
Lune™

EUCALYPTUS
2494/324
Lune™

GINGERSNAP
2494/118
Lune™

GREY MIST
2494/340
Lune™

INDIGO
2494/30
Lune™

LEAD
2494/237
Lune™

MOSS

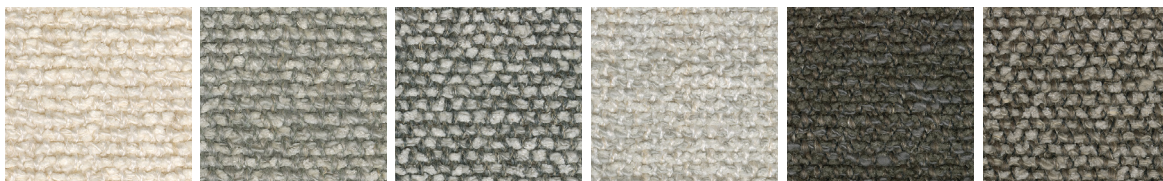

BEIGE
0004
Lissoni Sofa™

LIGHT GREY
0005
Lissoni Sofa™

GREY
0006
Lissoni Sofa™

SAND/GREY
0011
Lissoni Sofa™

DARK CLAY
0014
Lissoni Sofa™

CLAY
0015
Lissoni Sofa™

SURFACE SELECTION

Colours and materials may vary from the images shown.
Actual colour, gloss level and structure may vary.

SELECTED TEXTILE COLOURS

VANIR

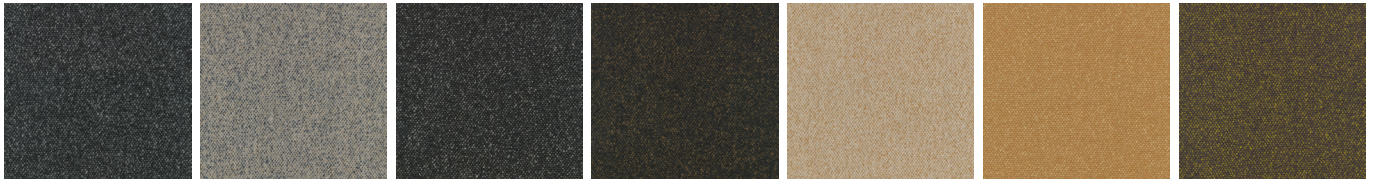

BLACK/GREY
193
Ant™
Grand Prix™
Lily™
Series 7™

SAND/BLUE
243
Ant™
Grand Prix™
Lily™
Series 7™

GRANITE BROWN
373
Ant™
Grand Prix™
Lily™
Series 7™

BLACK/MUSTARD
393
Ant™
Grand Prix™
Lily™
Series 7™

BEIGE MUSTARD
413
Ant™
Grand Prix™
Lily™
Series 7™

CORN YELLOW
443
Ant™
Grand Prix™
Lily™
Series 7™

PURPLE/YELLOW
473
Ant™
Grand Prix™
Lily™
Series 7™

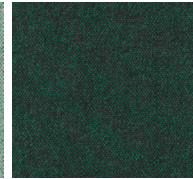
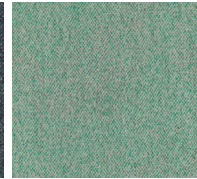
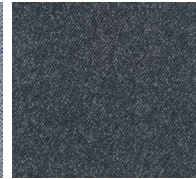
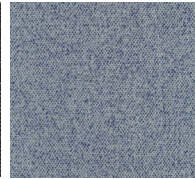

DARK PURPLE
693
Ant™
Grand Prix™
Lily™
Series 7™

LIGHT BLUE
733
Ant™
Grand Prix™
Lily™
Series 7™

DUSTY BLUE
773
Ant™
Grand Prix™
Lily™
Series 7™

LIGHT EMERALD GREEN
913
Ant™
Grand Prix™
Lily™
Series 7™

DARK EMERALD GREEN
983
Ant™
Grand Prix™
Lily™
Series 7™

SURFACE SELECTION

LEATHER

Please note that leather is a natural material with natural variation in colour and surface structure. The presence of scars and marks from bites etc. on the leather may occur and are characteristics of genuine leather.

Further information about materials, care and maintenance can be found on www.fritzhanzen.com.

CUSTOMER'S OWN LEATHER (COL)

Customers can supply their own leather. Prices excluding leather as well as leather requirements can be given on inquiry. Please note that only very few types of leather/qualities are suitable. Fritz Hansen retains the right to reject the qualities we find unsuitable.

SPECIAL LEATHER COLOURS

On inquiry and at a surcharge, special leather colours may be available for the models available with leather upholstery.

	AURA	BUFFED	EMBRACE	ESSENTIAL	GRACE	INTENSE	NATURAL	RAW	RUSTIK	SOFT	WILD
ANT™ FRONT			●	●	●		●			●	
CHINA CHAIR™	●		●		●		●		●		
DOT™		●				●					●
DROP™	●		●	●	●		●		●		
EGG™	●		●	●	●		●		●		
FRED™				●							
GRAND PRIX™ FRONT			●	●	●		●			●	
GRAND PRIX™ FULL			●	●	●		●		●	●	
HIGH DOT™		●				●					●
LET™				●							
LILY™			●	●	●		●		●	●	
LITTLE GIRAFFE™	●		●	●	●		●		●		
LISSONI SOFA™			●	●	●		●		●	●	
LUNE™	●		●							●	
NO1™ SEAT CUSHION								●			
OKSEN™	●			●	●						
OXFORD™			●	●	●		●		●	●	
POT™	●		●	●	●		●		●		
SERIES 7™ FRONT			●	●	●		●			●	
SERIES 7™ FULL			●	●	●		●		●	●	
SERIES 7™ SEAT CUSHION						●		●			●
SERIES 3300™	●		●	●	●		●		●		
SWAN™	●		●	●	●		●		●		
SWAN SOFA™	●		●	●	●		●		●		
VICO DUO™ FRONT			●	●	●		●			●	
VICO DUO™ FULL			●	●	●		●		●	●	

SURFACE SELECTION

Colours and materials may vary from the images shown.
Actual colour, gloss level and structure may vary.

LEATHER

AURA

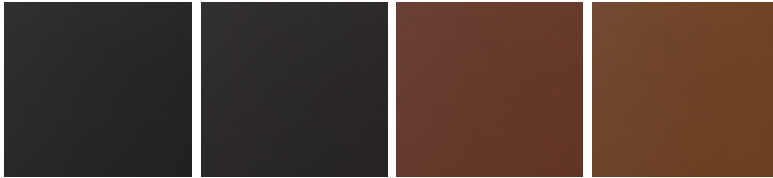

BLACK

BLACK BROWN

COGNAC

WALNUT

China Chair™
Drop™
Egg™
Little Giraffe™
Lune™
Oksen™
Pot™
Series 3300™
Swan™
Swan Sofa™

CATEGORY: 4
CHROME-TANNED, TOP-COATED, STRONG FULL-GRAIN
AND DURABLE SURFACE.
THICKNESS 1.4-1.6 MM.

EMBRACE

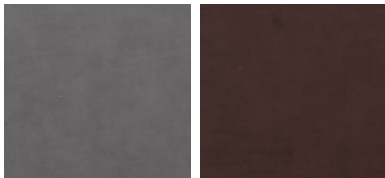

CONCRETE GREY

CHOCOLATE

Ant™
China Chair™
Drop™
Egg™
Grand Prix™
Lily™
Little Giraffe™
Lissoni Sofa™
Lune™
Oxford™
Pot™
Series 7™
Series 3300™
Swan™
Swan Sofa™
Vico Duo™

CATEGORY: 5
CHROME-TANNED, FULLY GRAINED, EXTRAORDINARY SOFT ANILINE
WITH A SPECIAL WAXING GIVING A SLIGHTLY 'OILY' SURFACE. COLOUR
VARIATIONS, VISIBLE NATURAL MARKINGS E.G. NECK WRINKLES.
THICKNESS 1.2-1.4 MM.

ESSENTIAL

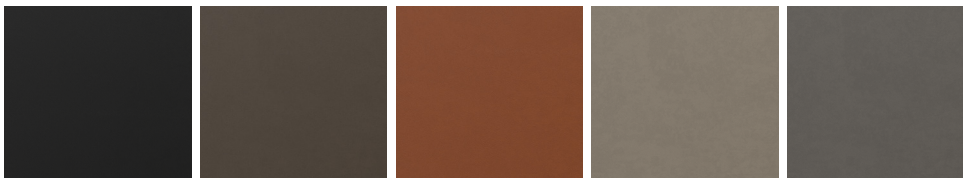

BLACK

STONE

WALNUT

LIGHT GREY

LAVA

Ant™
Drop™
Egg™
Fred™
Grand Prix™
Let™
Lily™
Little Giraffe™
Lissoni Sofa™
Oksen™
Oxford™
Pot™
Series 7™
Series 3300™
Swan™
Swan Sofa™
Vico Duo™

CATEGORY: 3
CHROME-TANNED, LIGHTLY POLISHED, TOP-COATED
AND GRAIN PRINTED DURABLE SURFACE.
THICKNESS 1.0-1.2 MM.

SURFACE SELECTION

Colours and materials may vary from the images shown.
Actual colour, gloss level and structure may vary.

LEATHER

GRACE



BLACK

Ant™
China Chair™
Drop™
Egg™
Grand Prix™
Lily™
Little Giraffe™
Lissoni Sofa™
Oksen™
Oxford™
Pot™
Series 7™
Series 3300™
Swan™
Swan Sofa™
Vico Duo™

DARK BROWN

CATEGORY: 5
VEGETABLE AND CHROME-TANNED, ANILINE,
FULL-GRAIN WITH LIGHT STRUCTURE AND
LIGHT IMPREGNATION. BECOMES LIGHTER
AND PATINATED WITH USE, VISIBLE NATURAL
MARKINGS.
THICKNESS 1.2-1.4 MM.

WALNUT

NATURAL



NATURAL

Ant™
China Chair™
Drop™
Egg™
Grand Prix™
Lily™
Little Giraffe™
Lissoni Sofa™
Oxford™
Pot™
Series 7™
Series 3300™
Swan™
Swan Sofa™
Vico Duo™

CATEGORY: 5
VEGETABLE-TANNED, CHROME-FREE, NATURAL
LEATHER, NO COLOUR OR PROTECTIVE FINISH.
BECOMES DARKER AND PATINATED WITH USE,
VISIBLE NATURAL MARKINGS.
THICKNESS 1.2-1.4 MM.

RUSTIK

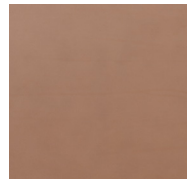

RUSTIK

China Chair™
Drop™
Egg™
Grand Prix™
Lily™
Little Giraffe™
Lissoni Sofa™
Oxford™
Pot™
Series 7™
Series 3300™
Swan™
Swan Sofa™
Vico Duo™

CATEGORY: 5
VEGETABLE-TANNED, CHROME-FREE, ANILINE,
NO PROTECTIVE FINISH, LIGHT IMPREGNATION,
VISIBLE NATURAL MARKS. BECOMES LIGHTER
AND PATINATED WITH USE.
THICKNESS 1.2-1.4 MM.

SOFT



BLACK

Ant™
Grand Prix™
Lily™
Lissoni Sofa™
Little Giraffe™
Lune™
Oxford™
Series 7™
Vico Duo™

BLACK BROWN

CATEGORY: 4
CHROME-TANNED, SEMI-ANILINE, FULL-GRAIN WITH LIGHT STRUCTURE
AND SURFACE FINISH.
THICKNESS 1.0-1.2 MM.

COGNAC

WALNUT

SURFACE SELECTION

Colours and materials may vary from the images shown.
Actual colour, gloss level and structure may vary.

SEAT CUSHIONS

DROP™ (3110SC)



GREY
TEXTILE
SALSA 3/36

BLACK
TEXTILE
SALSA 3/39

NAP™ (KS70)

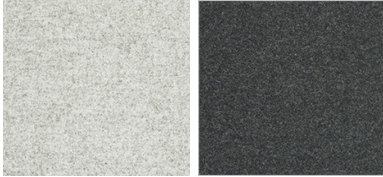

LIGHT GREY
TEXTILE
DIVINA MELANGE 120

DARK GREY
TEXTILE
DIVINA MELANGE 180

NO1™ (N70/N71)



DARK BLUE/GREY
TEXTILE
REMIX 173

BEIGE
TEXTILE
REMIX 233

DARK BROWN
TEXTILE
REMIX 393

BLACK
LEATHER
RAW

NO2™ RECYCLE (N02-70)

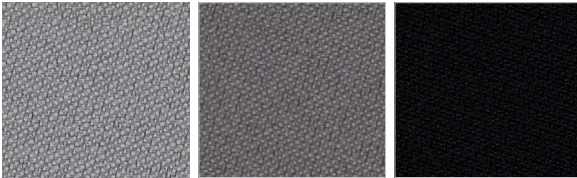

LIGHT GREY
TEXTILE
JUST 60118

DARK GREY
TEXTILE
JUST 60121

BLACK
TEXTILE
JUST 60999

SERIES 7™ (3107SC)

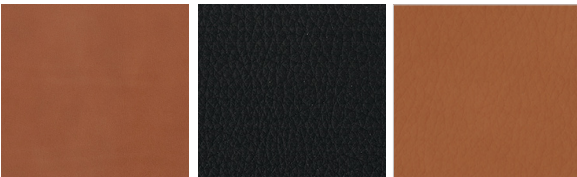

WALNUT
LEATHER
WILD

BLACK
LEATHER
RAW

BROWN
LEATHER
INTENSE

VICO DUO™ (VM170)

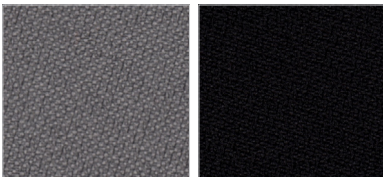

DARK GREY
TEXTILE
JUST 60121

BLACK
TEXTILE
JUST 60999

SURFACE SELECTION

Colours and materials may vary from the images shown.
Actual colour, gloss level and structure may vary.

COLOURED VENEER



ASH - WHITE

Ant™
Grand Prix™
Series 7™



ASH - LIGHT BEIGE

Ant™
Grand Prix™
Series 7™



ASH - DEEP CLAY

Ant™
Grand Prix™
Series 7™



ASH - NINE GREY

Ant™
Grand Prix™
Series 7™



ASH - BLACK

AJ Trolley™
Ant™
Dot™
FH3605™
High Dot™
Grand Prix™
Series 7™
Series 7™ Junior
Stub™
Vico Duo™



ASH - TRUE YELLOW

Ant™
Grand Prix™
Series 7™



ASH - BURNT YELLOW

Ant™
Grand Prix™
Series 7™
Series 7™ Junior



ASH - PARADISE ORANGE

Ant™
Grand Prix™
Series 7™



ASH - VENETIAN RED

Ant™
Grand Prix™
Series 7™



ASH - PALE ROSE

Ant™
Grand Prix™
Series 7™



ASH - WILD ROSE

Ant™
Children's Chairs
Grand Prix™
Series 7™

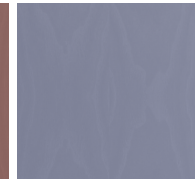

ASH - LAVENDER BLUE

Ant™
Grand Prix™
Series 7™



ASH - DUSK BLUE

Ant™
Grand Prix™
Series 7™



ASH - MIDNIGHT BLUE

Ant™
Children's Chairs
Grand Prix™
Series 7™



ASH - OLIVE GREEN

Ant™
Grand Prix™
Series 7™



ASH - EVERGREEN

Ant™
Grand Prix™
Series 7™
Series 7™ Junior



OAK - BLACK

NO1™

SURFACE SELECTION

Colours and materials may vary from the images shown.
Actual colour, gloss level and structure may vary.

LACQUERED VENEER

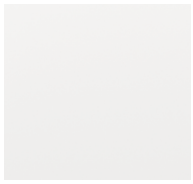

WHITE

Ant™
Grand Prix™
Series 7™



LIGHT BEIGE

Ant™
Grand Prix™
Series 7™



DEEP CLAY

Ant™
Grand Prix™
Series 7™



NINE GREY

Ant™
Grand Prix™
Series 7™



BLACK

Ant™
Grand Prix™
Series 7™



TRUE YELLOW

Ant™
Grand Prix™
Series 7™



BURNT YELLOW

Ant™
Grand Prix™
Series 7™



PARADISE ORANGE

Ant™
Grand Prix™
Series 7™



VENETIAN RED

Ant™
Grand Prix™
Series 7™



PALE ROSE

Ant™
Grand Prix™
Series 7™



WILD ROSE

Ant™
Grand Prix™
Series 7™



LAVENDER BLUE

Ant™
Grand Prix™
Series 7™



DUSK BLUE

Ant™
Grand Prix™
Series 7™



MIDNIGHT BLUE

Ant™
Grand Prix™
Series 7™



OLIVE GREEN

Ant™
Grand Prix™
Series 7™



EVERGREEN

Ant™
Grand Prix™
Series 7™

SURFACE SELECTION

Colours and materials may vary from the images shown.
Actual colour, gloss level and structure may vary.

CLEAR LACQUERED VENEER



MAPLE

Ant™
Series 7™



BEECH

Ant™
N01™
Series 7™



ASH

Ant™
Series 7™
Stub™



CHERRY

Ant™
Series 7™



OREGON PINE

Ant™
Children's Chairs
Series 7™



ELM

Ant™
Series 7™



OAK

Analog™
Ant™
Grand Prix™
N01™
NAP™ (base)
Planner™ Shelving
Pluralis™
Series 7™
Series 7™ Junior
Stub™
Vico Duo™

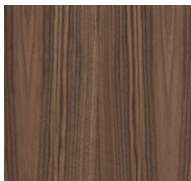

WALNUT

Analog™
Ant™
Circular
Dot™
Egg™ Table
FH3605™
Grand Prix™
High Dot™
Lily™
Pluralis™
Rectangular
Series 7™
Supercircular™
Superellipse™
Vico Duo™

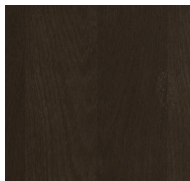

OAK - DARK STAINED/
FULL DARK STAINED

Ant™
Series 7™

SURFACE SELECTION

Colours and materials may vary from the images shown.
Actual colour, gloss level and structure may vary.

CLEAR LACQUERED SOLID WOOD

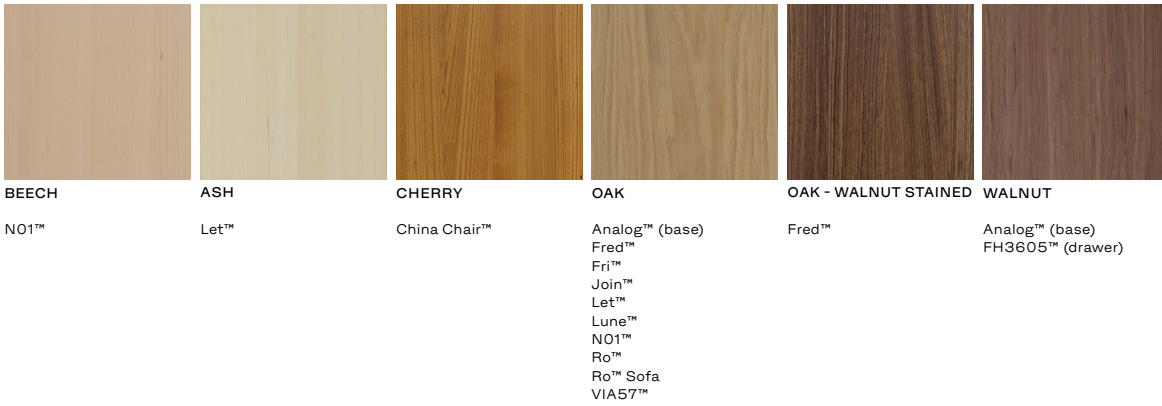

OILED SOLID WOOD



UNTREATED SOLID WOOD

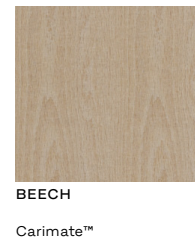

COLOURED SOLID WOOD



SURFACE SELECTION

Colours and materials may vary from the images shown.
Actual colour, gloss level and structure may vary.

PLASTIC (ABS)

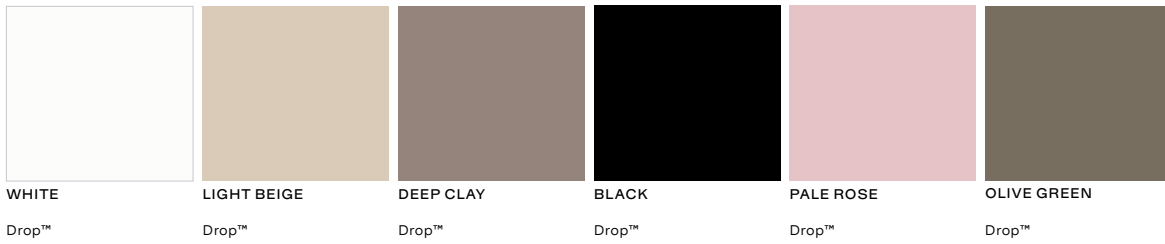

PLASTIC (PA)



RECYCLED PLASTIC (PP)

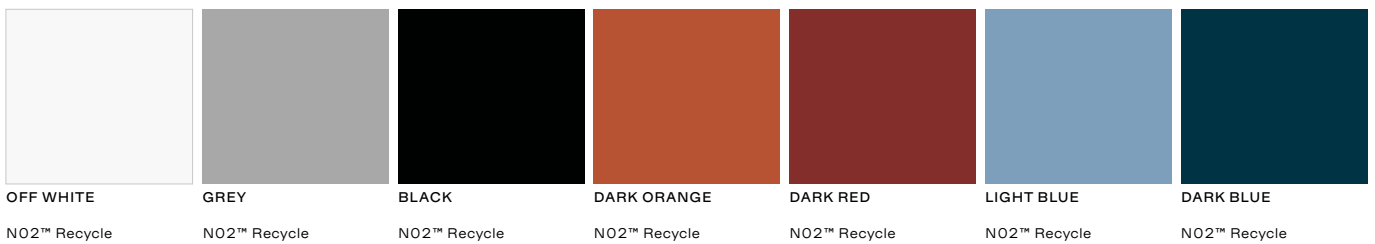

SURFACE SELECTION

Colours and materials may vary from the images shown.
Actual colour, gloss level and structure may vary.

LAMINATE (FENIX)



LAMINATE (POLYREY)

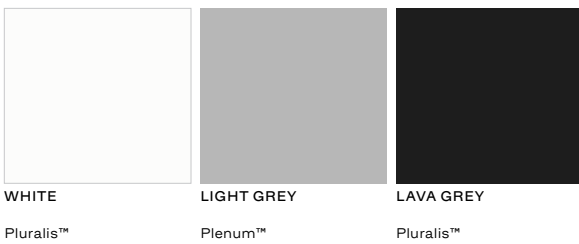

LAMINATE (PFLEIDERER)



COMPACT LAMINATE

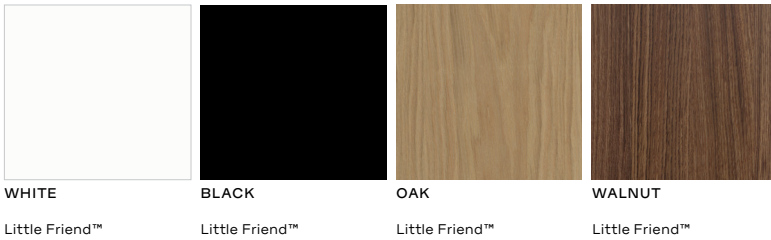

LINOLEUM



HONED MARBLE

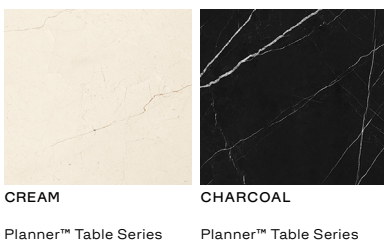

GLASS

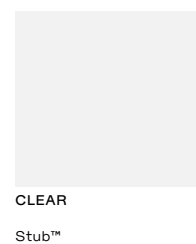

SURFACE SELECTION

Colours and materials may vary from the images shown.
Actual colour, gloss level and structure may vary.

POWDER COATED METAL (STEEL OR ALUMINIUM)

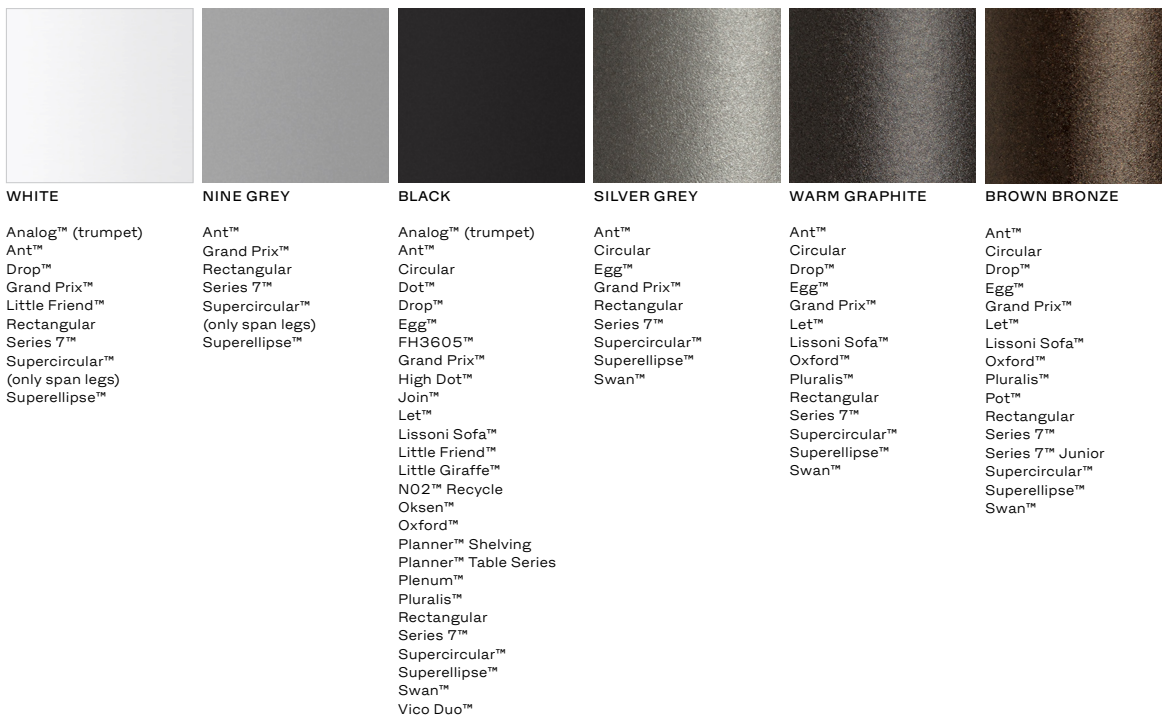
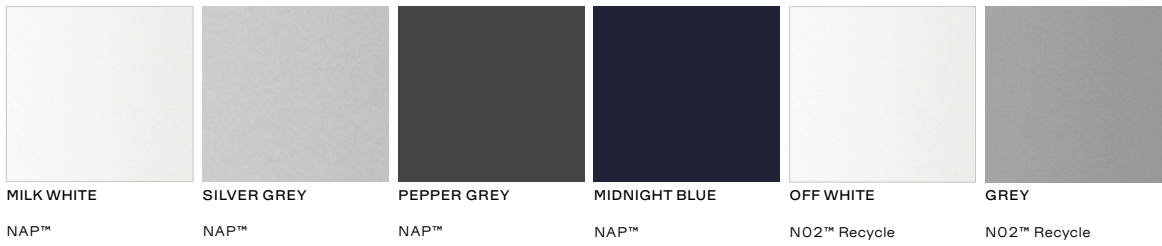

SURFACE SELECTION

Colours and materials may vary from the images shown.
Actual colour, gloss level and structure may vary.

STEEL

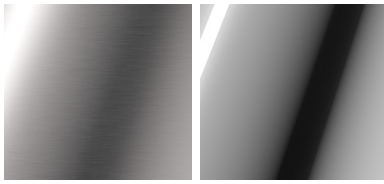

BRUSHED STAINLESS
STEEL - MATT

Lissoni Sofa™

CHROMED STEEL
- BRIGHT

Ant™
Children's Chairs
Circular
Coat Tree™
Dot™
Drop™
Egg™ Table
FH3605™
Grand Prix™
High Dot™
Let™
Lily™
Little Giraffe™
NO2™ Recycle
NAP™
Pot™
Rectangular
Series 3300™
Series 7™
Series 7™ Junior
Supercircular™
(only span legs)
Superellipse™
Vico Duo™

ALUMINIUM

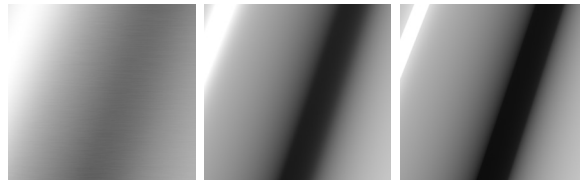

BRUSHED
- MATT

Circular
Egg™
Favn™
Fri™
Little Giraffe™
(swivel base)
Lune™
Oksen™
Oxford™
Ro™
Ro™ Sofa
Swan™
Swan Sofa™
Supercircular™
(only pedestal base)

POLISHED
- BRIGHT

Little Friend™
NO2™ Recycle
(swivel base)
Pluralis™

CHROMED
- BRIGHT

Oxford™

PAPER CORD

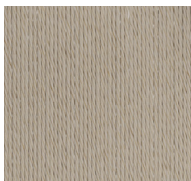

NATURAL

Carimate™

PRICE LIST 2024

LIGHTING

EURO / VAT 21% / 11.2023

FRITZ HANSEN

CONTENT

03 • GENERAL TERMS AND CONDITIONS

LIGHTING

- 05 • AQ01™
- 06 • Avion™
- 07 • Calabash™
- 08 • Caravaggio™
- 09 • Caravaggio™ Matt
- 10 • Caravaggio™ Opal
- 11 • Caravaggio™ Read
- 12 • Clam™
- 13 • Concert™
- 14 • Cross-Plex™
- 15 • KAISER idell™
- 16 • KAISER idell™
- 17 • Maluma™
- 18 • MS Series
- 19 • Night Owl™
- 20 • Online™
- 21 • Orient™
- 22 • PM-02
- 23 • Suspence™

GENERAL TERMS AND CONDITIONS

CURRENCY & EFFECTIVE DATE

This price list is valid from 1 November 2023 and cancels all prior price lists.

Reservation is made for any errors and omissions. Furthermore, below general terms and conditions shall apply to all contracts under which Fritz Hansen A/S (Fritz Hansen) is the supplier/sub-supplier.

ORDERING

Orders must be placed through Fritz Hansen's web-based order system called the Partner Portal (www.fritzhanzen.com - professional). Orders are not binding until the customer has received a written order confirmation from Fritz Hansen.

Price lists state the recommended retail price (RRP) or prices excl. VAT exclusive of freight and fees. All prices can be changed without notice. Changes to the collection such as discontinued products and/or items out of stock can occur even when stated differently in the price list. Updated information will be available on the partner portal only.

ORDER CANCELLATION

Orders can be cancelled in accordance with the below rules:

	ORDERS CANCELLED 0-3 DAYS AFTER ORDER CONFIRMATION HAS BEEN SENT	ORDERS CANCELLED 3-14 DAYS AFTER ORDER CONFIRMATION HAS BEEN SENT
STANDARD PRODUCTS	FEE: NONE	FEE: 5% OF NET PRICE EXCL. VAT.
SPECIALS OR MODIFIED PRODUCTS	FEE: FULL PRICE	

Change and cancellation of order after 14 days from receipt of the order confirmation is not possible.

DELIVERY

The following freight rates apply:

RATE	PER ORDER
EU+UK+NO+CH+US*	DKK 200 / € 55 / £ 50 / SEK 600 / NOK 550 / USD 55 EXCL. VAT.
REST OF THE WORLD	TO BE PICKED UP AT FRITZ HANSEN WAREHOUSES

For markets EU+UK+NO+CH+US free freight offered according to the following rates: Free shipping from DKK 3.000 / € 400 / £ 350 / SEK 4.500 / NOK 4.000 / USD 500 total order value excl. VAT.

* For deliveries to outer areas such as islands in Portugal and Spain as well as Svalbard in Norway and others, a surcharge of DKK 420 / € 56 / £ 42 / NOK 580 per parcel will apply.

Standard delivery terms:

- Denmark: DDP delivery address (INCO-Terms 2020)
- Countries within the EU: DDP delivery address (INCO-Terms 2020)
- European countries outside the EU: DAP delivery address (INCO-Terms 2020)
- USA & Canada: DDP delivery address (INCO-Terms 2020)
- Japan: DDP delivery address (INCO-Terms 2020)
- South Korea: DAT Seoul Airport (INCO-Terms 2020)
- Middle East, Asia, South and Central America, Australia: FCA Fritz Hansen warehouses in Denmark and Poland (INCO-Terms 2020)

For FCA: The goods must be picked up at the Fritz Hansen warehouses no later than 30 calendar days after the confirmed shipping date of the consolidated order. Address(es) for pickup will be specified on the commercial invoice. If the goods are not picked up, Fritz Hansen will charge the customer DKK 24 / € 3 / USD 4 per day per pallet.

If the partner so desires, Fritz Hansen can deliver at the end user's address against an additional fee.

CLAIMS

The physical product must be inspected upon delivery. Damage incurred in transit as well as any defects and deficiencies on the product incurred as a result of transportation must be recorded on the POD upon delivery. Fritz Hansen must be notified in writing of any claims about product defects and deficiencies within 48 hours of delivery. If the claims are made in due time and with the acceptance of Fritz Hansen, the customer is entitled to demand a replacement delivery or to have the defect remedied. The customer cannot demand a reduction or a compensation. Claims/replacements can only be made to the customer's address if delivery has not been made directly to the end user.

TERMS OF PAYMENT

Terms of payment are 30 days net cash from invoice date. Invoices are issued and dated when the goods are dispatched. In case of late payment, interest will be charged at a rate of 1.5 % for every month or part thereof as from the due date. Interest invoices are payable net cash within eight days. Fritz Hansen can decide that the customer shall pay in advance, if the customer's balance is or has previously been due, or if the order amount exceeds the credit limit approved by Fritz Hansen.

OBSERVATION OF TITLE

Title to the goods shall not pass to the customer until Fritz Hansen (or any third party to whom Fritz Hansen has assigned its rights to the purchase price) has received the full purchase price and been reimbursed any expenses incurred.

WARRANTY

Fritz Hansen provides a standard five-year warranty on standard products within the collections Furniture and Skagerak Collection (Indoor & Outdoor) against defects in materials and workmanship. For the Arne Jacobsen shell chairs (Ant™, Grand Prix™, Lily™, Series 7™), the standard warranty is 10 years. Within the Furniture collection, an extended warranty of up to 10 years is provided on selected products, provided they have been registered online on www.fritzhanzen.com/my-fh (see table on the next page for details).

For the Poul Kjærholm collection, the standard warranty is 20 years except for PK0 A™ and PK60™, which is 10 years, and the PK15™, which is 5 years. Wicker and French Cane have a warranty of 2 years.

For the Lighting, Accessories and Skagerak Collection Accessories the standard warranty is 2 years. Specific for the Lighting category: Transformers, ballasts, light sources, and other electronic devices are subject to the warranty terms of the manufacturer in question. Fritz Hansen does not cover costs related to installation and dismantling, replacement of ballasts/transformers and other similar costs related to electricians and the like.

The warranty on all collections does not extend to ordinary tear, wear or damage to upholstery. On any material, textile, or leather which is not listed in our price lists configured on a specific product, the standard warranty is 2 years. The warranty is void upon subsequent changes to the product.

Additional warranty conditions can be found on www.fritzhanzen.com.

LIMITATION OF LIABILITY

Fritz Hansen will assume no liability for any loss as a result of delays, defects or any other breach of contract, unless such loss was caused by gross negligence on the part of Fritz Hansen. Fritz Hansen will assume no liability for any indirect loss, including loss of profits, operating loss, goodwill, loss of customers, running costs or any other consequential economic loss.

CHOICE OF LAW AND JURISDICTION

Disputes between Fritz Hansen and its customers shall be subject to Danish law, except for the international civil law rules of Danish law, and shall be settled by Fritz Hansen's home court.

MEASUREMENTS

The stated measurements act only as a guideline. The measurements can vary, and size difference on a product can occur.

FORCE MAJURE

Fritz Hansen is without liability for non-performance of Fritz Hansen's obligations in respect to any orders received, if such non-performance is due to circumstances out of Fritz Hansen's reasonable control, which prevent the fulfilment of the purchase agreement or makes the fulfilment unreasonably burdensome. As examples of such circumstances the following can be mentioned: Industrial dispute and other circumstances which are beyond the control of the parties, such as fire, war, mobilization or calling in for military service of similar extent, requisition, seizure, exchange controls, riots or disturbances, shortage of means of transportation, ordinary scarcity of goods, restrictions of motive power and defects in or late performance from sub-suppliers due to any of the aforementioned circumstances.

The above circumstances only lead to exemption from liability if their influence on the fulfilment of the purchase agreement could not be anticipated at the conclusion of the agreement. Fritz Hansen must without undue delay notify the customer in writing if any such circumstances, occurrence and cessation, if Fritz Hansen wishes to invoke any grounds of exemption from liability.

Regardless of what follows from these general conditions of sales and delivery, any party is entitled to terminate the purchase agreement by notifying the other party in writing, if the fulfilment of the agreement is prevented for more than 6 months due to one of the above circumstances.

Unless mandatory rules preclude this, Fritz Hansen is in no case liable to the customer for operating losses, lost earnings, or other financial consequential damages under these general conditions for sale and delivery.

PRIVACY POLICY

At Fritz Hansen, confidentiality and data protection is a high priority. Guidelines for processing of personal data and description of the customer's and end users' rights according to applicable data protection law is governed by Fritz Hansen's privacy policy available on Fritz Hansen's website.

WARRANTY OVERVIEW

Price list collections	Furniture Collection						Poul Kjærholm Collection				Skagerak Collection		Lighting Collection	Accessories Collection					
	Textile Cushions	Leather (1)	Leather (2)	Bases (3)	Bases (4)	Movable parts (5)	Anrt™ Grand Prix™, Lily™, Series 7™	Shells, Tabletops	Tabletops (6)	China Chair™	French Cane, Wicker	PK15™	PKO A™ & PK60™	Poul Kjærholm Collection	Outdoor	Indoor	Lighting	Accessories	Skagerak Collection
2 years										x							x	x	x
5 years	x	x		x		x		x			x			x	x				
10 years			x*		x*		x	x*				x**							
20 years									x**				x**						

1. Leather: Soft and Essential
2. Leather: Aura, Rustik, Natural, Grace and Embrace
3. Bases: Lacquered and Wooden (chairs), Powder coated (chairs and tables)
4. Bases: Aluminium, Chrome and Wooden (tables)
5. Moveable parts: Automatic return, Tilt, Height-adjustable, Swivel, Castors and Extension mechanism
6. Tabletops: Lacquer under tabletop, Lacquer on edges and Surface on tabletop

* Additional with registration on www.fritzhansen.com/my-fh

** Standard without registration



AQ01™
ANNE QVIST 2017

The AQ01™ has curvy edges and matt finish. The aluminium shade can be switched on, off and dimmed directly at the top. The diffuser prevents glare and gives off direct downward illumination in a symmetric rotational pattern. The delicate arms connecting the two joints hide the wire within and keep it in place with an internal spring. The AQ01™ can be configured as a plug-in, table lamp or wall mounted lamp.

SINGLE UNIT (FOR REPLACEMENT)

MODEL	COLOUR	CORD LGT. M	CORD SPECIFICATION	PRODUCT CODE	EXCL. VAT	INCL. VAT
AQ01 - LED	White	2,5	White, PVC + adapter	62698505	288	349
AQ01 - LED	Black	2,5	Black, PVC + adapter	62698408	288	349
AQ01 - LED	Blue	2,5	Blue, PVC + adapter	62698606	288	349

PLUG-IN

MODEL	COLOUR	CORD LGT. M	CORD SPECIFICATION	PRODUCT CODE	EXCL. VAT	INCL. VAT
AQ01 + Plug-in	White	2,5	White, PVC + adapter	62716005	329	399
AQ01 + Plug-in	Black	2,5	Black, PVC + adapter	62716208	329	399
AQ01 + Plug-in	Blue	2,5	Blue, PVC + adapter	62716106	329	399

TABLE

MODEL	COLOUR	CORD LGT. M	CORD SPECIFICATION	PRODUCT CODE	EXCL. VAT	INCL. VAT
AQ01 + Table base	White	2,5	White, PVC + adapter	62699105	346	419
AQ01 + Table base	Black	2,5	Black, PVC + adapter	62699008	346	419
AQ01 + Table base	Blue	2,5	Blue, PVC + adapter	62699206	346	419

WALL

MODEL	COLOUR	CORD LGT. M	CORD SPECIFICATION	PRODUCT CODE	EXCL. VAT	INCL. VAT
AQ01 + Wall base	White	2,5	White, PVC + adapter	62698805	313	379
AQ01 + Wall base	Black	2,5	Black, PVC + adapter	62698708	313	379
AQ01 + Wall base	Blue	2,5	Blue, PVC + adapter	62698906	313	379

PLUG-IN

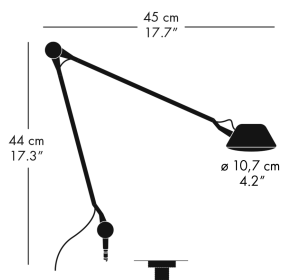

TABLE

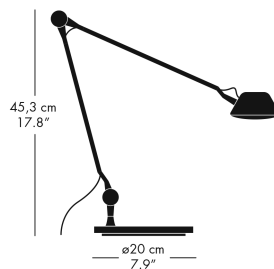

WALL

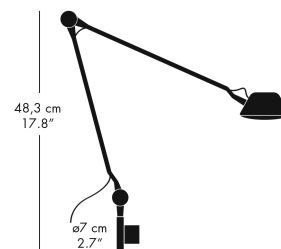



A childhood fascination with Zeppelin airships gliding with steady grace across the sky, inspired Iskos-Berlin to create Avion™. The large, oval pendant hovers playfully in the air, ready to change its direction to suit your desire. The pendant emits a soft, diffuse light that creates a cosy, natural atmosphere. Avion™ can be arranged in a regular formation, as a dynamic pack or similarly it can be suspended in a line to mark a passage through a building.

PENDANT

MODEL	COLOUR	CORD LGT. M	CORD SPECIFICATION	PRODUCT CODE	EXCL. VAT	INCL. VAT
2xE27	Polyethylene, white PC/ABS	6	White, PVC	54402705	676	819

TABLE-FLOOR

MODEL	COLOUR	CORD LGT. M	CORD SPECIFICATION	PRODUCT CODE	EXCL. VAT	INCL. VAT
2XE27	Polyethylene, white PC/ABS	6	Black, PVC	31000312	643	779

TABLE-FLOOR-TERRASSE

MODEL	COLOUR	CORD LGT. M	CORD SPECIFICATION	PRODUCT CODE	EXCL. VAT	INCL. VAT
2XE27	Polyethylene, white PC/ABS	6	Black, PVC	31000412	643	779

Not permanent outdoor installation

CANOPY

MODEL	COLOUR	PRODUCT CODE	EXCL. VAT	INCL. VAT
Adjustable canopy	White	18615605	222	269

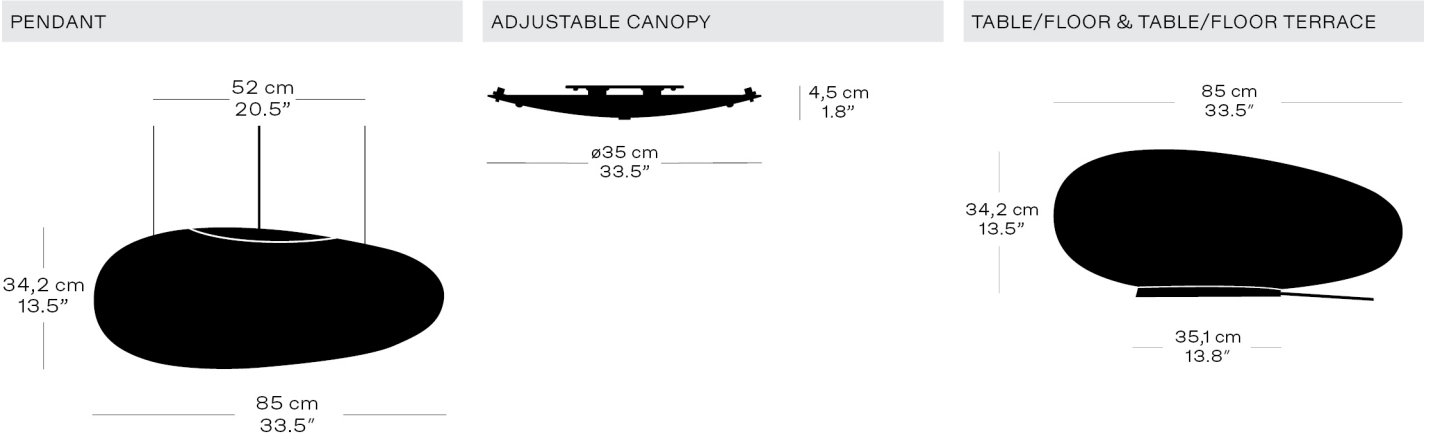



CALABASH™ KOMPLOT DESIGN 2010

11.2023

Calabash™ is authentic craftsmanship from the core to the surface. The distinctive shape of the calabash pumpkin inspired the Danish design studio Komplot Design to create a vivid and sculptural design that stands out – with or without the light turned on. The Calabash™ pendant comes with a coloured aluminium shade in two sizes – P1 and P2.

PENDANT

MODEL	COLOUR	CORD LGT. M	CORD SPECIFICATION	CANOPY COLOUR	PRODUCT CODE	EXCL. VAT	INCL. VAT
P1	Gold	3	Black, textile	Black	14017274	288	349
P1	Silver	3	Black, textile	Black	14017172	288	349
P2	Gold	3	Black, textile	Black	14018274	395	479
P2	Silver	3	Black, textile	Black	14018172	395	479
P3	Silver	6	Black, textile	Black	14023172	718	869

PENDANT P1

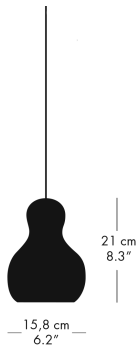

PENDANT P2

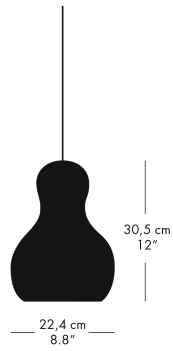

PENDANT P3

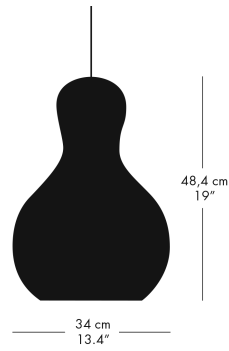



The Caravaggio™ range of high-gloss pendants was launched in 2005 and instantly emerged as a design icon. The distinctive red cord and high-gloss aluminium shade surface clearly highlight one of the most striking pendant designs of the 2000s. The highly praised design by Cecilie Manz elegantly combines a recognisable shape with a modern expression.

PENDANT

MODEL	COLOUR	CORD LGT. M	CORD SPECIFICATION	CANOPY COLOUR	PRODUCT CODE	EXCL. VAT	INCL. VAT
P1	White	3	Grey, textile	White	54006905	271	329
P1	Black	3	Red, textile	White	54006708	271	329
P1	BlackBlack	3	Black, textile	Black	54007608	271	329
P2	White	3	Grey, textile	White	54007005	371	449
P2	Black	3	Red, textile	White	54006808	371	449
P2	BlackBlack	3	Black, textile	Black	54007708	371	449
P3	White	6	Grey, textile	White	74009705	676	819
P3	Black	6	Red, textile	White	74009608	676	819
P3	BlackBlack	6	Black, textile	Black	54020208	676	819

DIFFUSER

MODEL	COLOUR	PRODUCT CODE	EXCL. VAT	INCL. VAT
P3	Opal	18173405	98	119

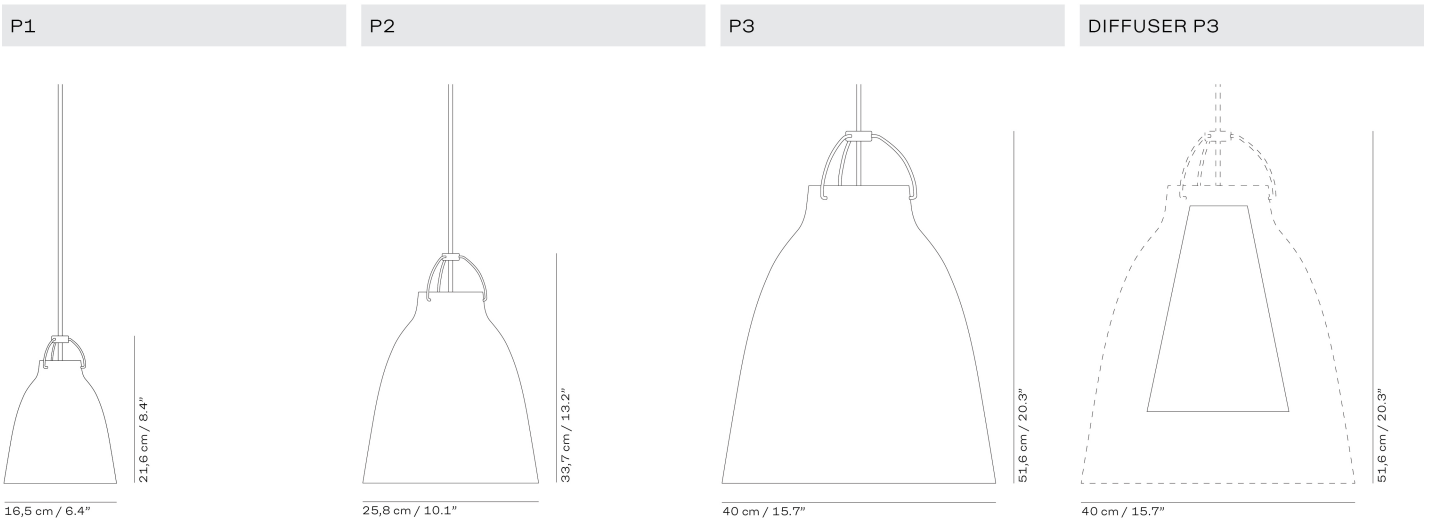



CARAVAGGIO™ OPAL
CECILIE MANZ 2005

11.2023

With Caravaggio™ Opal, Cecilie Manz has combined the characteristic Caravaggio™ design with a completely different lighting effect. The opal glass shade emits a soft, dimmed light, which is particularly suitable for rooms where a more evocative lighting is required. The lamp is suspended by the three renowned shackles, which here form a raw and masculine contrast to the feminine opal hand-blown glass. The P0 comes with an integrated LED source.

PENDANT

MODEL	COLOUR	CORD LGT. M	CORD SPECIFICATION	CANOPY COLOUR	PRODUCT CODE	EXCL. VAT	INCL. VAT
P0 LED	Opal glass	3	Silver-grey, textile	White	94722705	247	299
P1	Opal glass	3	Silver-grey, textile	White	84183105	313	379
P2	Opal glass	3 w. wire	Silver-grey, textile	White	84183205	495	599
P3	Opal glass	6 w. wire	Silver-grey, textile	White	84184105	866	1.049

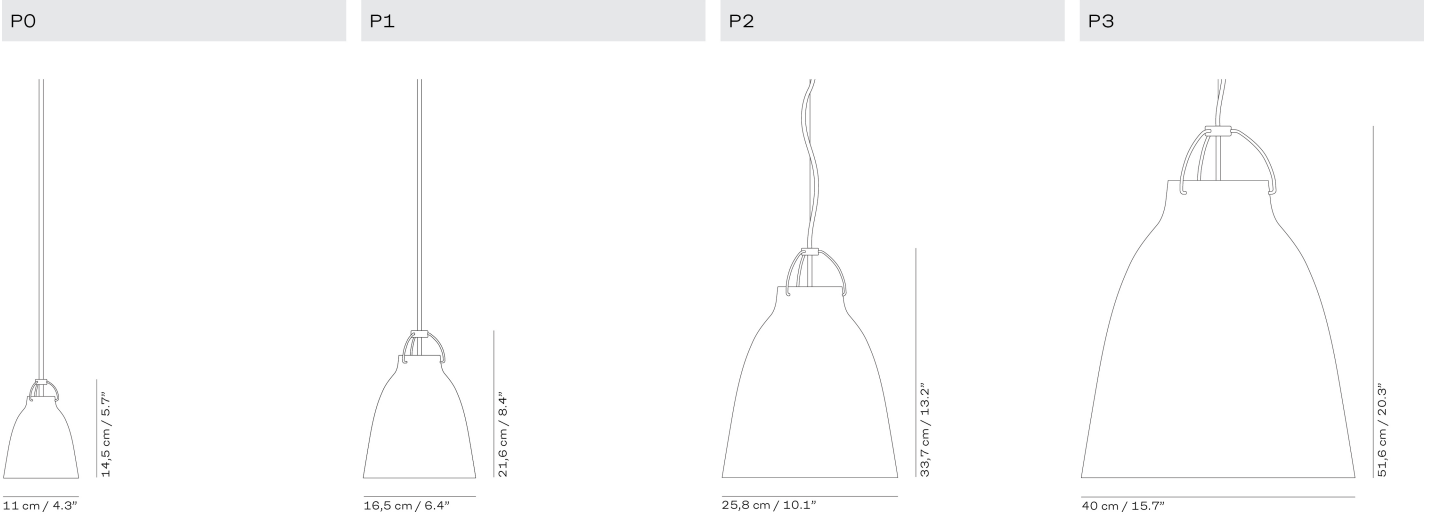



CARAVAGGIO™ READ CECILIE MANZ 2005

11.2023

Based on the well-known Caravaggio™ shape, Cecilie Manz has created a functional reading wall lamp. The iconic shade comes either in matt lacquered aluminium or in opal glass and is installed on a flexible tube, allowing you to tilt the shade and direct the light. The lamps can be rotated for different needs. The Caravaggio™ Read is equipped with a three-level touch-control dimmer to enable adjustable light intensity. The switch is discreetly located on the underside of the wall mount for easy access.

WALL						
MODEL	COLOUR	CORD LGT. M	CORD SPECIFICATION	PRODUCT CODE	EXCL. VAT	INCL. VAT
White	White	1,5	White, PVC	23041405	304	369
Grey25	Grey25	1,5	Grey25, PVC	13041212	304	369
Black	Black	1,5	Black, PVC	23041308	304	369
Opal	Opal	1,5	Grey25, PVC	53403205	304	369

WALL

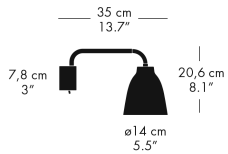



CLAM™ AHM & LUND 2019

11.2023

With beautiful, mouth-blown glass and brass details, the Clam™ pendant by Ahm & Lund is a new classic within lighting excellence. The Clam™ pendant lamp is inspired by a seashell and, like a shell hides its pearl, it 'hides' its light source. Its diffused light creates beautiful atmosphere and ambiance. The pendant is available in two sizes.

PENDANT

MODEL	COLOUR	CORD LGT. M	CORD SPECIFICATION	CANOPY COLOUR	PRODUCT CODE	EXCL. VAT	INCL. VAT
Ø440	Opal/brass	6	Black, textile	Brass	94724305	1.528	1.849
Ø550	Opal/brass	6	Black, textile	Brass	94722205	1.900	2.299

Ø440

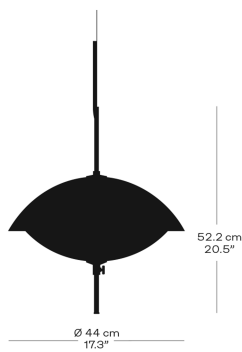

Ø550

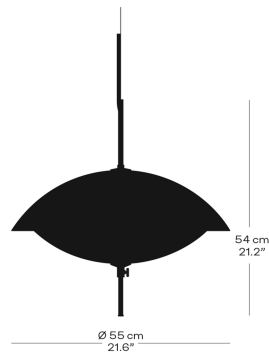



CONCERT™ JØRN UTZON 2005

11.2023

Concert™ gives a pleasant, non-glaring light without compromising the strength of illumination. The chosen shade configuration is visually characteristic of Jørn Utzon and reminds us of his greatest work — the Sydney Opera House. Concert™ is designed with four shades and a parabola of drawn steel, resting on a glass cone suspension. The suspension unit sends out a pleasant, even light between the shades. The bottom shade casts light downward to the parabola, which then diffuses it.

PENDANT

MODEL	COLOUR	CORD LGT. M	CORD SPECIFICATION	CANOPY COLOUR	PRODUCT CODE	EXCL. VAT	INCL. VAT
P1	White	3	White, textile	White	54003405	428	519
P1	Black	3	Black, textile	Black	14721808	428	519
P3	White	6 w. wire	White, textile	White	74003505	759	919
P3	Black	6 w. wire	Black, textile	Black	14721908	759	919

PENDANT P1

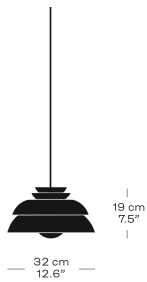

PENDANT P3

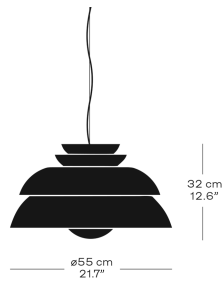

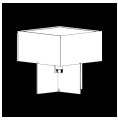

CROSS-PLEX™ BODIL KJÆR 1961

11.2023

Cross-Plex™ is a great example of Bodil Kjær's functionalistic expression with its clean and straight lines. It is centred on a cross-base of clear acrylic that creates an elegant play of surfaces and incorporates the cord as a central part of the design. The light from the cubic lampshade in opal acrylic creates a cosy atmosphere.

TABLE

MODEL	COLOUR	CORD LGT. M	CORD SPECIFICATION	PRODUCT CODE	EXCL. VAT	INCL. VAT
T-300	Opal/clear	3	Black, textile	82716605	428	519
T-500	Opal/clear	3	Black, textile	82716705	387	469

TABLE T-300

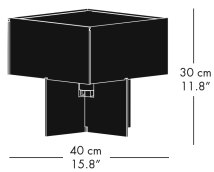
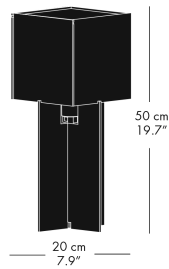

TABLE T-500





PENDANT

MODEL	COLOUR	CORD LGT. M	CORD SPECIFICATION	CANOPY COLOUR	PRODUCT CODE	EXCL. VAT	INCL. VAT
6722-P	Russet red	3	Black, textile	Silver	94721001	263	319
6722-P	Soft ochre	3	Black, textile	Silver	94721102	263	319
6722-P	Smooth slate	3	Black, textile	Silver	94721212	263	319
6722-P	Black	3	Black, textile	Silver	94721908	263	319
6722-P	Easy grey	3	Black, textile	Brass	14290812	263	319
6631-P	White	3	Black, textile	Silver	64700505	362	439
6631-P	Black	3	Black, textile	Silver	64700608	362	439
6631-P	Matt black	3	Black, textile	Silver	64700708	362	439
6631-P	Ruby red	3	Black, textile	Silver	64700801	362	439
6631-P	Black Brass	3	Black, textile	Brass	14721208	362	439
6631-P	Venetian Red	3	Black, textile	Silver	24003003	362	439
6631-P	Olive green	3	Black, textile	Silver	24002905	362	439

WALL

MODEL	COLOUR	CORD LGT. M	CORD SPECIFICATION	PRODUCT CODE	EXCL. VAT	INCL. VAT
6718-W	White	2	White, textile	63702305	602	729
6718-W	Black	2	Black, textile	63702408	602	729
6718-W	Matt black	2	Black, textile	63702508	602	729
6718-W	Easy grey	2	Black, textile	13721612	602	729

TABLE

MODEL	COLOUR	CORD LGT. M	CORD SPECIFICATION	PRODUCT CODE	EXCL. VAT	INCL. VAT
6556-T	White	2	Black, textile	62702905	561	679
6556-T	Black	2	Black, textile	62703008	561	679
6556-T	Matt black	2	Black, textile	62703108	561	679
6556-T	Easy grey	2	Black, textile	12291112	561	679
6556-T	Venetian Red	2	Black, textile	22001503	561	679
6556-T	Olive green	2	Black, textile	22001405	561	679
6631-T Luxus	White	2	Black, textile	62701305	701	849
6631-T Luxus	Black	2	Black, textile	62701408	701	849
6631-T Luxus	Matt black	2	Black, textile	62701508	701	849
6631-T Luxus	Dark green	2	Black, textile	62701706	701	849
6631-T Luxus	Ruby red	2	Black, textile	62701601	701	849
6631-T Luxus	Matt black/brass	2	Black, textile	92720908	701	849
6631-T Luxus	Easy grey, brass	2	Black, textile	92720912	701	849

FLOOR

MODEL	COLOUR	CORD LGT. M	CORD SPECIFICATION	PRODUCT CODE	EXCL. VAT	INCL. VAT
6556-F	White	2	Black, textile	61703505	809	979
6556-F	Black	2	Black, textile	61703608	809	979
6556-F	Matt black	2	Black, textile	61703708	809	979
6556-F	Easy grey, brass	2	Black, textile	91721012	809	979
6556-F	Venetian Red	2	Black, textile	21000503	809	979
6556-F	Olive green	2	Black, textile	21000405	809	979
6580-F Luxus	White	2	Black, textile	61704105	908	1.099
6580-F Luxus	Black	2	Black, textile	61704208	908	1.099
6580-F Luxus	Matt black	2	Black, textile	61704308	908	1.099
6580-F Luxus	Matt black/brass	2	Black, textile	11721008	908	1.099



PENDANT 6722-P

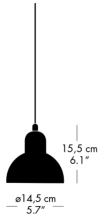

PENDANT 6631-P

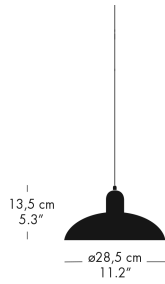

WALL 6718-W

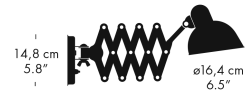
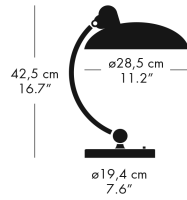

TABLE 6556-T



TABLE 6631-T LUXUS



FLOOR 6556-F

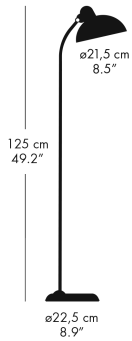

FLOOR 6580-F LUXUS

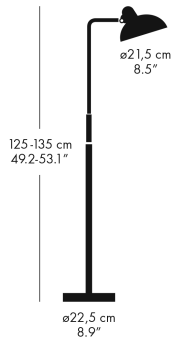



MALUMA™
FUMIE SHIBATA 2021

11.2023

The Maluma™ pendant comes with a hand-blown, frosted coloured glass shade, and a matching suspension. Available in delicate colours, the smoothly curved pendant adds a soft tone and modern expression to any environment. Off or illuminated, the Maluma™ retains its colour and provides both soft ambient light as well as functional downlight from its open underside.

PENDANT

MODEL	COLOUR	CORD LGT. M	CORD SPECIFICATION	CANOPY COLOUR	PRODUCT CODE	EXCL. VAT	INCL. VAT
H350	Moss	3	Black, textile	Black	94723428	362	439
H350	Plum	3	Black, textile	Black	94723503	362	439
H350	Rose	3	Grey25, textile	White	94723601	362	439

H350



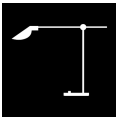

MS SERIES METTE SCHELDE 2023

11.2023

The MS lamp series - a clean, cool and modern lighting collection consisting of one floor lamp and two table lamps designed to set the perfect mood. Created by contemporary Danish designer Mette Schelde, the Nordic inspired design casts a subtle pointed light, ideal for focused working, and have a dimmable function to suit different moods and needs.

FLOOR

MODEL	COLOUR	CORD LGT. M	CORD SPECIFICATION	PRODUCT CODE	EXCL. VAT	INCL. VAT
MS011	Steel	3	Black, silicone	31000120	990	1.199
MS011	Black PVD	3	Black, silicone	31000208	990	1.199

TABLE

MODEL	COLOUR	CORD LGT. M	CORD SPECIFICATION	PRODUCT CODE	EXCL. VAT	INCL. VAT
MS021	Steel	3	Black, silicone	32000320	800	969
MS021	Black PVD	3	Black, silicone	32000408	800	969
MS022	Steel	3	Black, silicone	32000520	610	739
MS022	Black PVD	3	Black, silicone	32000608	610	739

MS011

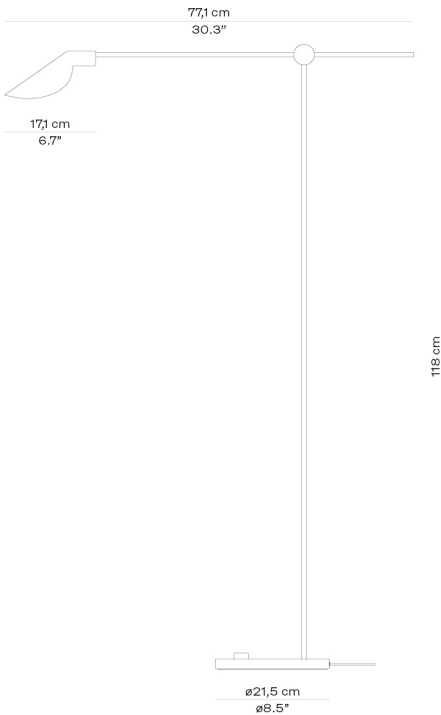

MS021

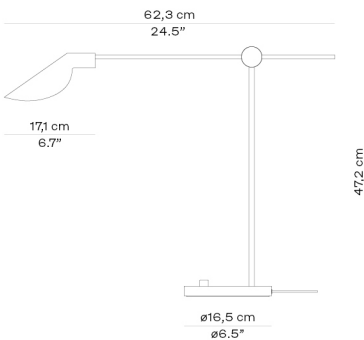

MS022

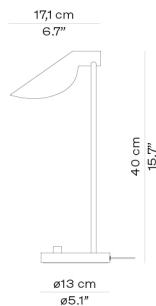



NIGHT OWL™
NIKOLAI WIIG HANSEN 2015

11.2023

The Night Owl™ consists of a conical base and oval shade, merging together to form a single unit of balanced proportions. The matt lacquered aluminium shade is complemented by either a natural ash or an aluminium base with a colour that matches the shade. The organic design of the Night Owl™ gives the lamp a friendly and almost human appearance – a lamp with a personality. Night Owl™ is suitable for standing on e.g. a sideboard, shelf, bedside table or in a window.

TABLE

MODEL	COLOUR	CORD LGT. M	CORD SPECIFICATION	PRODUCT CODE	EXCL. VAT	INCL. VAT
Night Owl	Midnight blue	2	Black, PVC	52698203	189	229
Night Owl	Smokey white	2	Black, PVC	52698305	189	229
Night Owl	Midnight blue/ash	2	Black, PVC	52698003	222	269
Night Owl	Smokey white/ash	2	Black, PVC	52698105	222	269
Night Owl Steel	Polished steel	2,5	Black, PVC	32000130	461	559
Night Owl Steel	Black PVD	2,5	Black, PVC	32000208	461	559

TABLE

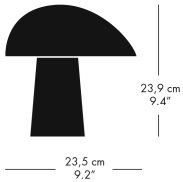



ONELINE™
KASPER KJELDGAARD 2022

11.2023

Masterfully shaped as a slender beam of light, Oneline is offered in three different finishes. Available in stainless steel, brushed brass and black PVD, each has polished brass details and silver tone suspension cables. The design is fitted with long-lasting LED technology and is dimmable. Suspended above a kitchen counter, desk or dining table or hung in a hallway or hotel lobby, Oneline has the unique ability to blend in while standing out.

PENDANT

MODEL	COLOUR	CORD LGT. M	CORD SPECIFICATION	PRODUCT CODE	EXCL. VAT	INCL. VAT
OneLine Brass	Brass	12	Silver, wire	14290518	726	879
OneLine Steel	Steel	12	Silver, wire	14290600	726	879
OneLine Black	Black PVD	12	Silver, wire	14290708	726	879

CONNECTOR UNITS

MODEL	COLOUR	PRODUCT CODE	EXCL. VAT	INCL. VAT
Connector Unit	Brass	18631518	23	29
Connector Unit	Steel	18631600	23	29
Connector Unit	Black PVD	18631708	23	29

ONELINE

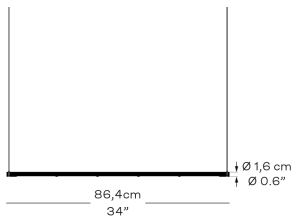



ORIENT™
JO HAMMERBORG 1963

11.2023

Orient™ was designed by Jo Hammerborg in 1963 and relaunched by Fritz Hansen in 2013. Revitalized in close collaboration with the Hammerborg family, the Orient™ pendant is a flawless light design with excellent luminous efficacy, and is made from the finest quality materials. The pendant's organically shaped shade made of aluminium or copper is connected to the cord with a delicate wooden joint and gives a soft, pleasant light without any glare.

PENDANT

MODEL	COLOUR	CORD LGT. M	CORD SPECIFICATION	CANOPY COLOUR	PRODUCT CODE	EXCL. VAT	INCL. VAT
P1	Aluminium/oak	3	Grey, textile	White	84716372	321	389
P1	Black/rosewood	3	Black, textile	Black	34192108	304	369
P1	Copper/rosewood	3	Black, textile	Black	34192064	453	549
P2	Aluminium/oak	3	Grey, textile	White	84716472	486	589
P2	Black/rosewood	3	Black, textile	Black	34192308	453	549
P2	Copper/rosewood	3	Black, textile	Black	34192264	676	819
P3	Aluminium/oak	6	Grey, textile	White	84716572	767	929
P3	Black/rosewood	6	Black, textile	Black	34192808	742	899

PENDANT P1

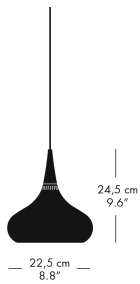

PENDANT P2

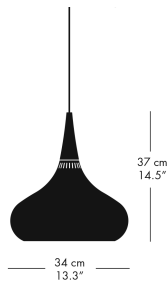

PENDANT P3

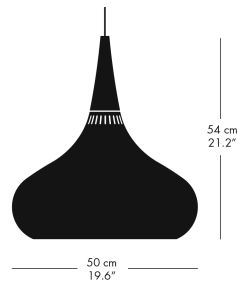



PM-02 PAUL MCCOBB 1950

11.2023

PM-02 is a simple, elegant table lamp designed by Paul McCobb, a renowned American mid-century designer with a Scandinavian design feel. This product is a continuation of Paul McCobb's Planner™ series, a line of simple, practical, moderately-priced products from the 1950s. The table lamp comes with an opal glass shade and two base variants: Untreated solid brass (which beautifully patinates over time and with use) or black lacquered steel.

MODEL	COLOUR	CORD LGT. M	CORD SPECIFICATION	PRODUCT CODE	EXCL. VAT	INCL. VAT
PM-02	Opal/black	2.5	Black, textile	82719708	222	269
PM-02	Opal/brass	2.5	Black, textile	82719518	288	349

PM-02

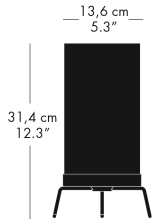



GamFratesi's inspiration for the Suspence™ pendant lamp series is translating a movement into a physical form and the shape of the lamp has been created by a soft pull, visually and physically connecting the cord with the shade. The infinity diffuser concentrates the light and prevents glare while creating an elegant optical illusion of infinite depth. The Suspence™ pendant comes with a matt lacquered aluminum shade and a colour-coordinated cord.

PENDANT

MODEL	COLOUR	CORD LGT. M	CORD SPECIFICATION	CANOPY COLOUR	PRODUCT CODE	EXCL. VAT	INCL. VAT
P1	White	3	White, PVC	White	54400205	304	369
P1	Light grey	3	Matt light grey, PVC	White	54400612	304	369
P1	Black	3	Black, PVC	Black	54400508	304	369
P1	Copper	3	Black, PVC	Black	54403364	470	569
P1.5	Powder burgundy	3	Powder burgundy	White	84718201	412	499
P1.5	Pale pearl	3	Pale pearl	Black	84718102	412	499
P1.5	Light grey	3	Light grey	White	84718012	412	499
P2	White	3	White, PVC	White	54400305	519	629
P2	Light grey	3	Matt light grey, PVC	White	54400812	519	629
P2	Black	3	Black, PVC	Black	54400708	519	629
P2	Copper	3 w. wire	Black, PVC	Black	54403564	949	1.149

PENDANT P1

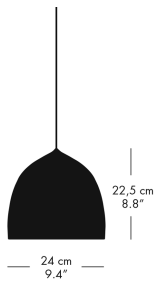

PENDANT P1.5

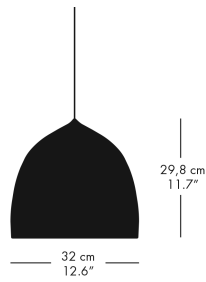

PENDANT P2

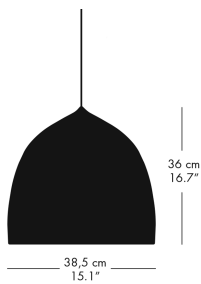

PENDANT P2 W. WIRE

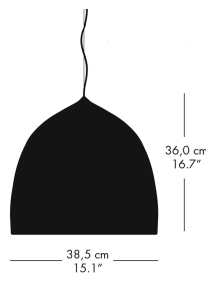

PRICE LIST 2024

POUL KJÆRHOLM

EURO / EXCL. VAT 21% / 11.2023

FRITZ HANSEN

CONTENT

03 • GENERAL TERMS AND CONDITIONS

CHAIRS

- 05 • PK8™
- 06 • PK9™
- 07 • PK11™
- 08 • PK15™

LOUNGE AND SOFAS

- 09 • PKO A™
- 10 • PK4™
- 11 • PK20™
- 12 • PK22™
- 13 • PK24™
- 14 • PK25™
- 15 • PK26™
- 16 • PK31™
- 17 • PK33™
- 18 • PK80™
- 19 • PK81™
- 20 • PK91™

TABLES

- 21 • PK40™
- 22 • PK51™/PK55™
- 23 • PK54™/PK54A™
- 24 • PK58™
- 25 • PK60™
- 26 • PK61™/PK61A™
- 27 • PK62™
- 28 • PK63™/PK63A™
- 29 • PK65™
- 30 • PK71™

SURFACE SELECTION

- 31 • Surface Selection

GENERAL TERMS AND CONDITIONS

CURRENCY & EFFECTIVE DATE

This price list is valid from 1 November 2023 and cancels all prior price lists.

Reservation is made for any errors and omissions. Furthermore, below general terms and conditions shall apply to all contracts under which Fritz Hansen A/S (Fritz Hansen) is the supplier/sub-supplier.

ORDERING

Orders must be placed through Fritz Hansen's web-based order system called the Partner Portal (www.fritzhanzen.com - professional). Orders are not binding until the customer has received a written order confirmation from Fritz Hansen.

Price lists state the recommended retail price (RRP) or prices excl. VAT exclusive of freight and fees. All prices can be changed without notice. Changes to the collection such as discontinued products and/or items out of stock can occur even when stated differently in the price list. Updated information will be available on the partner portal only.

ORDER CANCELLATION

Orders can be cancelled in accordance with the below rules:

	ORDERS CANCELLED 0-3 DAYS AFTER ORDER CONFIRMATION HAS BEEN SENT	ORDERS CANCELLED 3-14 DAYS AFTER ORDER CONFIRMATION HAS BEEN SENT
STANDARD PRODUCTS	FEE: NONE	FEE: 5% OF NET PRICE EXCL. VAT.
SPECIALS OR MODIFIED PRODUCTS	FEE: FULL PRICE	

Change and cancellation of order after 14 days from receipt of the order confirmation is not possible.

DELIVERY

The following freight rates apply:

RATE	PER ORDER
EU+UK+NO+CH+US*	DKK 200 / € 55 / £ 50 / SEK 600 / NOK 550 / USD 55 EXCL. VAT.
REST OF THE WORLD	TO BE PICKED UP AT FRITZ HANSEN WAREHOUSES

For markets EU+UK+NO+CH+US free freight offered according to the following rates: Free shipping from DKK 3.000 / € 400 / £ 350 / SEK 4.500 / NOK 4.000 / USD 500 total order value excl. VAT.

* For deliveries to outer areas such as islands in Portugal and Spain as well as Svalbard in Norway and others, a surcharge of DKK 420 / € 56 / £ 42 / NOK 580 per parcel will apply.

Standard delivery terms:

- Denmark: DDP delivery address (INCO-Terms 2020)
- Countries within the EU: DDP delivery address (INCO-Terms 2020)
- European countries outside the EU: DAP delivery address (INCO-Terms 2020)
- USA & Canada: DDP delivery address (INCO-Terms 2020)
- Japan: DDP delivery address (INCO-Terms 2020)
- South Korea: DAT Seoul Airport (INCO-Terms 2020)
- Middle East, Asia, South and Central America, Australia: FCA Fritz Hansen warehouses in Denmark and Poland (INCO-Terms 2020)

For FCA: The goods must be picked up at the Fritz Hansen warehouses no later than 30 calendar days after the confirmed shipping date of the consolidated order. Address(es) for pickup will be specified on the commercial invoice. If the goods are not picked up, Fritz Hansen will charge the customer DKK 24 / € 3 / USD 4 per day per pallet.

If the partner so desires, Fritz Hansen can deliver at the end user's address against an additional fee.

CLAIMS

The physical product must be inspected upon delivery. Damage incurred in transit as well as any defects and deficiencies on the product incurred as a result of transportation must be recorded on the POD upon delivery. Fritz Hansen must be notified in writing of any claims about product defects and deficiencies within 48 hours of delivery. If the claims are made in due time and with the acceptance of Fritz Hansen, the customer is entitled to demand a replacement delivery or to have the defect remedied. The customer cannot demand a reduction or a compensation. Claims/replacements can only be made to the customer's address if delivery has not been made directly to the end user.

TERMS OF PAYMENT

Terms of payment are 30 days net cash from invoice date. Invoices are issued and dated when the goods are dispatched. In case of late payment, interest will be charged at a rate of 1.5 % for every month or part thereof as from the due date. Interest invoices are payable net cash within eight days. Fritz Hansen can decide that the customer shall pay in advance, if the customer's balance is or has previously been due, or if the order amount exceeds the credit limit approved by Fritz Hansen.

OBSERVATION OF TITLE

Title to the goods shall not pass to the customer until Fritz Hansen (or any third party to whom Fritz Hansen has assigned its rights to the purchase price) has received the full purchase price and been reimbursed any expenses incurred.

WARRANTY

Fritz Hansen provides a standard five-year warranty on standard products within the collections Furniture and Skagerak Collection (Indoor & Outdoor) against defects in materials and workmanship. For the Arne Jacobsen shell chairs (Ant™, Grand Prix™, Lily™, Series 7™), the standard warranty is 10 years. Within the Furniture collection, an extended warranty of up to 10 years is provided on selected products, provided they have been registered online on www.fritzhanzen.com/my-fh (see table on the next page for details).

For the Poul Kjærholm collection, the standard warranty is 20 years except for PK0 A™ and PK60™, which is 10 years, and the PK15™, which is 5 years. Wicker and French Cane have a warranty of 2 years.

For the Lighting, Accessories and Skagerak Collection Accessories the standard warranty is 2 years. Specific for the Lighting category: Transformers, ballasts, light sources, and other electronic devices are subject to the warranty terms of the manufacturer in question. Fritz Hansen does not cover costs related to installation and dismantling, replacement of ballasts/transformers and other similar costs related to electricians and the like.

The warranty on all collections does not extend to ordinary tear, wear or damage to upholstery. On any material, textile, or leather which is not listed in our price lists configured on a specific product, the standard warranty is 2 years. The warranty is void upon subsequent changes to the product.

Additional warranty conditions can be found on www.fritzhanzen.com.

LIMITATION OF LIABILITY

Fritz Hansen will assume no liability for any loss as a result of delays, defects or any other breach of contract, unless such loss was caused by gross negligence on the part of Fritz Hansen. Fritz Hansen will assume no liability for any indirect loss, including loss of profits, operating loss, goodwill, loss of customers, running costs or any other consequential economic loss.

CHOICE OF LAW AND JURISDICTION

Disputes between Fritz Hansen and its customers shall be subject to Danish law, except for the international civil law rules of Danish law, and shall be settled by Fritz Hansen's home court.

MEASUREMENTS

The stated measurements act only as a guideline. The measurements can vary, and size difference on a product can occur.

FORCE MAJURE

Fritz Hansen is without liability for non-performance of Fritz Hansen's obligations in respect to any orders received, if such non-performance is due to circumstances out of Fritz Hansen's reasonable control, which prevent the fulfilment of the purchase agreement or makes the fulfilment unreasonably burdensome. As examples of such circumstances the following can be mentioned: Industrial dispute and other circumstances which are beyond the control of the parties, such as fire, war, mobilization or calling in for military service of similar extent, requisition, seizure, exchange controls, riots or disturbances, shortage of means of transportation, ordinary scarcity of goods, restrictions of motive power and defects in or late performance from sub-suppliers due to any of the aforementioned circumstances.

The above circumstances only lead to exemption from liability if their influence on the fulfilment of the purchase agreement could not be anticipated at the conclusion of the agreement. Fritz Hansen must without undue delay notify the customer in writing if any such circumstances, occurrence and cessation, if Fritz Hansen wishes to invoke any grounds of exemption from liability.

Regardless of what follows from these general conditions of sales and delivery, any party is entitled to terminate the purchase agreement by notifying the other party in writing, if the fulfilment of the agreement is prevented for more than 6 months due to one of the above circumstances.

Unless mandatory rules preclude this, Fritz Hansen is in no case liable to the customer for operating losses, lost earnings, or other financial consequential damages under these general conditions for sale and delivery.

PRIVACY POLICY

At Fritz Hansen, confidentiality and data protection is a high priority. Guidelines for processing of personal data and description of the customer's and end users' rights according to applicable data protection law is governed by Fritz Hansen's privacy policy available on Fritz Hansen's website.

WARRANTY OVERVIEW

Price list collections	Furniture Collection						Poul Kjærholm Collection				Skagerak Collection		Lighting Collection	Accessories Collection					
	Textile Cushions	Leather (1)	Leather (2)	Bases (3)	Bases (4)	Movable parts (5)	Ant [™] Grand Prix [™] , Lily [™] , Series 7 [™]	Shells, Tabletops	Tabletops (6)	China Chair [™]	French Cane, Wicker	PK15 [™]	PKO A [™] & PK60 [™]	Poul Kjærholm Collection	Outdoor	Indoor	Lighting	Accessories	Skagerak Collection
2 years										x							x	x	x
5 years	x	x		x		x		x			x			x	x				
10 years			x*		x*		x	x*				x**							
20 years									x**				x**						

1. Leather: Soft and Essential
2. Leather: Aura, Rustik, Natural, Grace and Embrace
3. Bases: Lacquered and Wooden (chairs), Powder coated (chairs and tables)
4. Bases: Aluminium, Chrome and Wooden (tables)
5. Moveable parts: Automatic return, Tilt, Height-adjustable, Swivel, Castors and Extension mechanism
6. Tabletops: Lacquer under tabletop, Lacquer on edges and Surface on tabletop

* Additional with registration on www.fritzhansen.com/my-fh

** Standard without registration



PK8™
POUL KJÆRHOLM 1978/2007

11.2023

The PK8™ chair comes with a black or white shell front upholstered in a select range of leather types. The three-legged base is made of anodised satin brushed aluminium, while the shell is made of lacquered nylon plastic (PA).

MODEL	DESCRIPTION	CATEGORY 4	CATEGORY 5
PK8	Chair, 44 cm, anodised satin brushed aluminium legs	2.395	2.974

CATEGORY 4: AURA
CATEGORY 5: GRACE

PK8

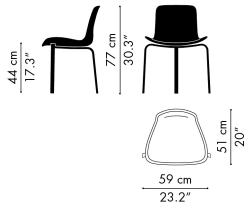



PK9™
POUL KJÆRHOLM 1960

11.2023

The PK9™ is a fully upholstered chair in a select range of leather types. The three-legged base is made of satin brushed stainless spring steel. The inner shell is made of nylon.

MODEL	DESCRIPTION	CATEGORY 4	CATEGORY 5
PK9	Chair, 43 cm, satin brushed stainless spring steel legs	4.957	5.536

CATEGORY 4: AURA
 CATEGORY 5: GRACE, EMBRACE, RUSTIK, NATURAL

OPTIONS

DESCRIPTION	PRICE
Glides	156

PK9

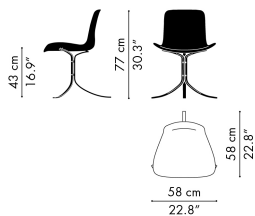



PK11™
POUL KJÆRHOLM 1957

11.2023

The PK11™ armchair comes with armrests in clear lacquered ash and an upholstered seat in a select range of leather types. The base is made of satin brushed stainless steel.

MODEL	DESCRIPTION	CATEGORY 4	CATEGORY 5
PK11	Armchair, 43/44 cm, satin brushed stainless steel legs	3.222	3.635

CATEGORY 4: AURA
CATEGORY 5: GRACE, EMBRACE, RUSTIK, NATURAL

PK11

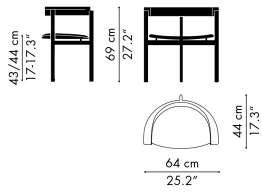



PK15™
POUL KJÆRHOLM 1979

11.2023

Consisting of two materials, the PK15 is available in two configurations: clear lacquered ash or black coloured ash, both with a natural French cane seat. An additional loose seat cushion in either black or natural leather is also available.

MODEL	DESCRIPTION	BLACK COLOURED ASH	CLEAR LACQUERED ASH
PK15	Chair, Wicker seat	2.313	2.561

MODEL	DESCRIPTION	CATEGORY
PK15CU	Seat cushion (loose)	5 437

CATEGORY 5 - SEE THE SURFACE SELECTION
Grace black or natural leather

PK15

PK15CU

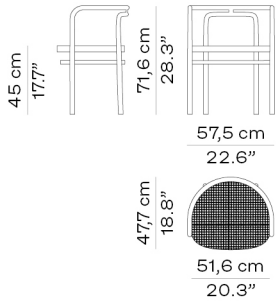



PKO A™
POUL KJÆRHOLM 1952

11.2023

The PKO A™ lounge chair is made from two pressure moulded veneer shells and is available in two different finishes: Clear lacquered Oregon Pine or black coloured ash. Between the two shell parts are two cinnabar red spacers.

MODEL	DESCRIPTION	BLACK COLOURED ASH	OREGON PINE
PKO A	Lounge chair, pressure moulded veneer	2.230	2.313

PKO A

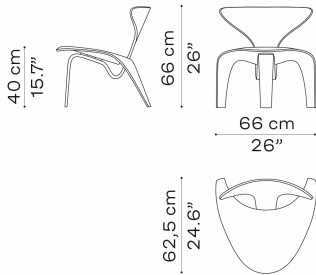

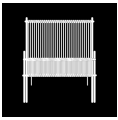

PK4™
POUL KJÆRHOLM

11.2023

The PK4™ lounge chair is made from stainless steel tubing and flag halyard in natural or black. The frame is available in brushed or black powder-coated steel. PK4™ is available in 3 configurations and with 3 optional cushions in either canvas or leather.

MODEL	DESCRIPTION	FLAG HALYARD	CANVAS	CATEGORY 5
PK4	PK4™ Lounge chair, brushed stainless or black powder coat	1.817		
PK4ST	PK4™ Lounge chair, brushed stainless or black powder coat, including cushion		2.065	2.147

FLAG HALYARD COLOURS - SEE THE SURFACE SELECTION
NATURAL, BLACK

CANVAS COLOURS - SEE THE SURFACE SELECTION
NATURAL, BLACK

CATEGORY 5 - SEE THE SURFACE SELECTION
Grace black leather

PK4

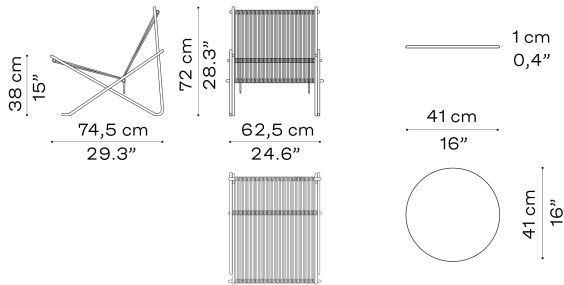



PK20™
POUL KJÆRHOLM 1968

11.2023

The PK20™ lounge chair is available in a select range of leather types or wicker. The leather version also includes a matching leather headrest. The base is made of matt chromed spring steel.

MODEL	DESCRIPTION	WICKER	CATEGORY 4	CATEGORY 5
PK20	Lounge chair, leather, leather headrest, matt chromed spring steel base		10.329	11.569
PK20	Lounge chair, wicker, matt chromed spring steel base	7.354		

CATEGORY 4: AURA
 CATEGORY 5: GRACE, EMBRACE, RUSTIK, NATURAL

PK20

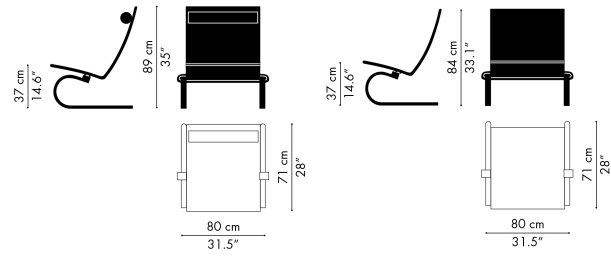



PK22™
POUL KJÆRHOLM 1956

11.2023

The PK22™ lounge chair is available in wicker, canvas and a select range of leather types. The base is made of satin brushed stainless spring steel.

MODEL	DESCRIPTION	WICKER	CANVAS	CATEGORY 4	CATEGORY 5
PK22	Lounge chair, satin brushed stainless spring steel base	3.470	3.470	4.296	4.957

CATEGORY 4: AURA
CATEGORY 5: GRACE, EMBRACE, RUSTIK, NATURAL

CANVAS COLOURS - SEE THE SURFACE SELECTION
NATURAL, BLACK

PK22

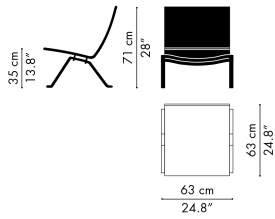



PK24™
POUL KJÆRHOLM 1965

11.2023

The PK24™ chaise longue is available in a select range of leather types or wicker. Both versions include a leather headrest. The base is made of satin brushed stainless spring steel.

MODEL	DESCRIPTION	CATEGORY 4	CATEGORY 5
PK24	Chaise longue, wicker, leather headrest, satin brushed stainless spring steel base	14.048	14.048
PK24	Chaise longue, leather, leather headrest, satin brushed stainless spring steel base	14.875	17.767

CATEGORY 4: AURA
CATEGORY 5: GRACE, EMBRACE, RUSTIK, NATURAL

PK24

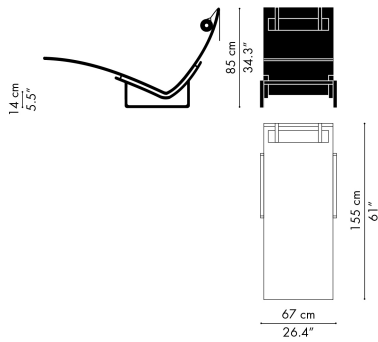



PK25™
POUL KJÆRHOLM 1951

11.2023

The PK25™ lounge chair is available in flag halyard, in natural or black. The base is made of matt chromed spring steel.

MODEL	DESCRIPTION	FLAG HALYARD
PK25	Lounge chair, matt chromed spring steel base	10.329

FLAG HALYARD COLOURS - SEE THE SURFACE SELECTION
NATURAL, BLACK

PK25

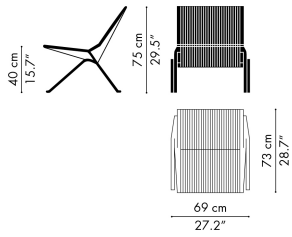



PK26™ POUL KJÆRHOLM 1956

11.2023

The PK26™ is a wall-mounted modular sofa. The frame is made in matt chromed spring steel, and the cushion core is made of hairlok (natural fibres and latex). The sofa is upholstered in a select range of leather types and an exclusive leather type called Niger leather (special trading terms apply).

MODEL	DESCRIPTION	CATEGORY 4	CATEGORY 5
PK26	1-seater sofa, wall-mounted, matt chromed spring steel frame	15.701	18.594
PK26	2-seater sofa, wall-mounted, matt chromed spring steel frame	31.404	37.189

CATEGORY 4: AURA
CATEGORY 5: GRACE, EMBRACE, RUSTIK, NATURAL

PK26-1

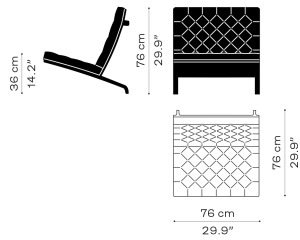

PK26-2

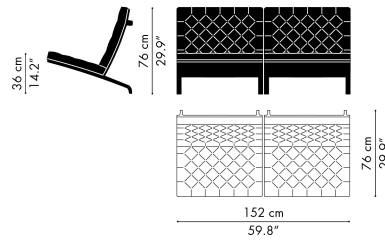



PK31™
POUL KJÆRHOLM 1958

11.2023

The PK31™ series is available as a lounge chair and a 2- or 3-seater sofa. It comes in a select range of leather types. The frame is made of matt chromed spring steel. Additional modules can be added.

MODEL	DESCRIPTION	CATEGORY 4	CATEGORY 5
PK31	Lounge chair, matt chromed spring steel base	14.461	16.528
PK31/2	2-seater sofa, matt chromed spring steel base	24.379	27.685
PK31/3	3-seater sofa, matt chromed spring steel base	33.883	38.428
	Additional modules for PK31, matt chromed spring steel base	9.916	11.156

CATEGORY 4: AURA
CATEGORY 5: GRACE, EMBRACE, RUSTIK, NATURAL

PK31

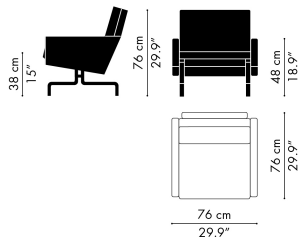

PK31/2

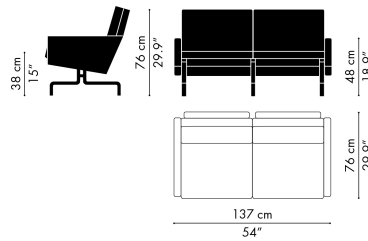

PK31/3

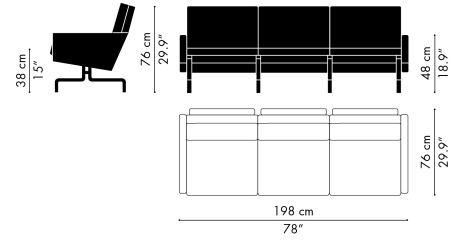



PK33™
POUL KJÆRHOLM 1959

11.2023

The PK33™ stool is available with a detachable cushion in a select range of leather types or canvas. The three-legged stool has a matt chromed spring steel base.

MODEL	DESCRIPTION	CANVAS	CATEGORY 4	CATEGORY 5
PK33	Stool, matt chromed spring steel base	2.974	3.552	3.883

CATEGORY 4: AURA
 CATEGORY 5: GRACE, EMBRACE, RUSTIK, NATURAL

CANVAS COLOURS - SEE THE SURFACE SELECTION
 NATURAL

PK33

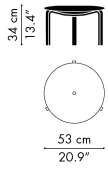

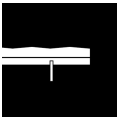

PK80™
POUL KJÆRHOLM 1957

11.2023

The PK80™ daybed comes with a cushion upholstered in a select range of leather types as well as in canvas. It rests on a painted plywood bedplate, and the cushion core is made of granulated foam and hairlok (natural fibres and latex). The base is made of satin brushed stainless steel.

MODEL	DESCRIPTION	CANVAS	CATEGORY 4	CATEGORY 5
PK80	Daybed, satin brushed stainless steel base	10.329	15.288	17.354

CATEGORY 4: AURA
CATEGORY 5: GRACE, EMBRACE, RUSTIK, NATURAL

CANVAS COLOURS - SEE THE SURFACE SELECTION
NATURAL

PK80

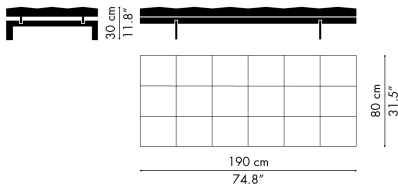

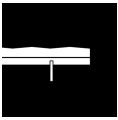

PK81™
POUL KJÆRHOLM 1959

11.2023

The PK81™ daybed is a square version of the classic daybed PK80™. The base is made of satin brushed stainless steel and the daybed rests on a painted plywood bedplate. The cushion core is made of granulated foam and hairlok (natural fibres and latex) and comes upholstered in a select range of leather types as well as in an exclusive leather type called Buffalo leather (special trading terms apply).

MODEL	DESCRIPTION	CATEGORY 4	CATEGORY 5
PK81	Daybed, satin brushed stainless steel base	21.486	25.205

CATEGORY 4: AURA
CATEGORY 5: GRACE, EMBRACE, RUSTIK, NATURAL

PK81

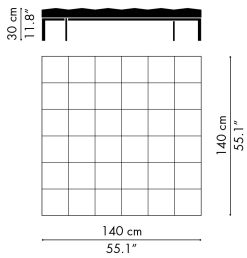



PK91™
POUL KJÆRHOLM 1961

11.2023

The PK91™ folding stool is available with a seat in a select range of leather types as well as in canvas. The base is made of satin brushed stainless steel.

MODEL	DESCRIPTION	CANVAS	CATEGORY 4	CATEGORY 5
PK91	Folding stool, satin brushed stainless steel base	2.891	3.470	3.718

CATEGORY 4: AURA
CATEGORY 5: GRACE, EMBRACE, RUSTIK, NATURAL

CANVAS COLOURS - SEE THE SURFACE SELECTION
NATURAL, BLACK

PK91

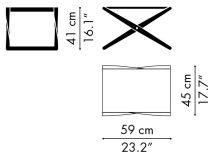



PK40™
POUL KJÆRHOLM 1980

11.2023

The PK40™ table comes with an upholstered tabletop in a select range of leather types. The base is made in satin brushed stainless steel.

MODEL	DESCRIPTION	CATEGORY 4	CATEGORY 5	H/L/W
PK40	Table, satin brushed stainless steel base	15.288	22.313	70/140/140

CATEGORY 4: AURA
CATEGORY 5: GRACE, EMBRACE, RUSTIK, NATURAL

PK40

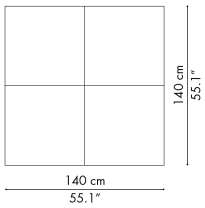
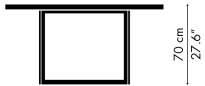



PK51™/PK55™
POUL KJÆRHOLM 1957

11.2023

The PK51™ and PK55™ tables come with a tabletop in clear lacquered ash veneer. The bases are made of satin brushed stainless steel.

MODEL	DESCRIPTION	ASH	H/L/W
PK51	Table, satin brushed stainless steel base	8.015	72/204/102
PK55	Table, satin brushed stainless steel base	6.197	72/180/90

PK51

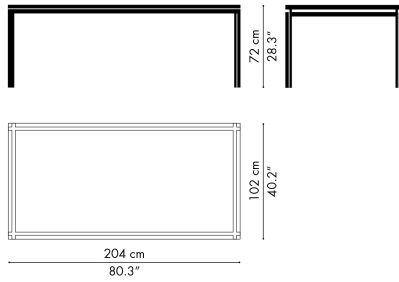

PK55

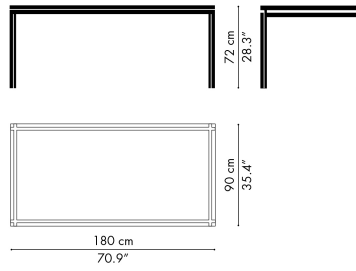



PK54™/PK54A™
POUL KJÆRHOLM 1963

11.2023

The PK54™ table is available with a tabletop in marble or granite. The square base is made of satin brushed stainless steel. The circular table top has an optional expansion ring consisting of six sections including a storage rack, both made of natural, untreated solid maple.

MODEL	DESCRIPTION	MARBLE	GRANITE	FAUSKE MARBLE	H/Ø
PK54	Table, satin brushed stainless steel base	9.503	9.503	11.569	69/140

MARBLE COLOURS - SEE THE SURFACE SELECTION
WHITE (HONED & ROLLED), BEIGE (HONED), GREY-BROWN (HONED) AND BLACK (HONED)

FAUSKE MARBLE - SEE THE SURFACE SELECTION
GREY-WHITE (ROLLED)

NOTE
THE MARBLE TABLETOPS ARE ALL UNIQUE WITH THEIR OWN PATTERN.

EXPANSION RING

MODEL	DESCRIPTION	SOLID MAPLE	
PK54A	Expansion ring, 6 sections, untreated solid maple, incl. storage rack	9.916	Ø210

PK54

PK54 + PK54A

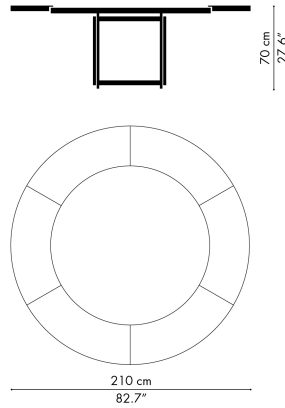
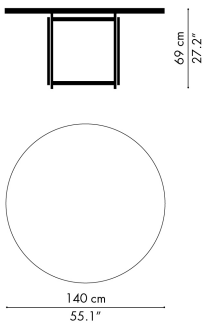



PK58™
POUL KJÆRHOLM 1963/2007

11.2023

The PK58™ table comes with a white polyester composite tabletop. The square base is made of anodised satin brushed aluminium.

MODEL	DESCRIPTION	WHITE	H/Ø
PK58	Table, anodised satin brushed aluminium base	4.627	71/130

PK58

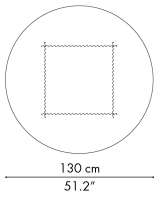
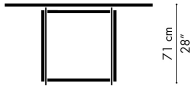



PK60™
POUL KJÆRHOLM 1952

11.2023

The PK60™ coffee table comes with a circular tempered glass tabletop and a three-legged base in pressure moulded veneer. The base is available in two different finishes: Clear Lacquered Oregon Pine or black coloured ash.

MODEL	DESCRIPTION	BLACK COLOURED ASH	OREGON PINE	H/Ø
PK60	Coffee table, pressure moulded veneer base	2.478	2.726	44/105

PK60

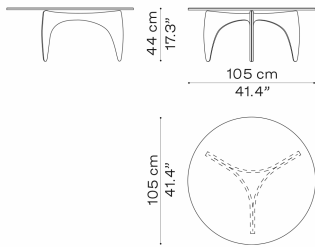



PK61™/PK61A™
POUL KJÆRHOLM 1956

11.2023

The PK61™ coffee table is available with different tabletops; slate, marble, granite and glass. PK61A™ is an enlarged version of PK61™ and is available with tabletops in marble, granite and glass. The base for both tables is made of satin brushed stainless steel.

MODEL	DESCRIPTION	SLATE	MARBLE	GRANITE	GLASS	FAUSKE MARBLE	H/L/W
PK61	Coffee table, satin brushed stainless steel base	3.552	3.552	3.552	4.131	4.131	32/80/80
PK61A	Coffee table, satin brushed stainless steel base		5.701	5.701	6.114	6.114	32/120/120

MARBLE COLOURS - SEE THE SURFACE SELECTION
 WHITE (HONED & ROLLED), BEIGE (HONED), GREY-BROWN (HONED) AND BLACK (HONED)

FAUSKE MARBLE - SEE THE SURFACE SELECTION
 GREY-WHITE (ROLLED)

NOTE
 THE MARBLE TABLETOPS ARE ALL UNIQUE WITH THEIR OWN PATTERN.

PK61

PK61A

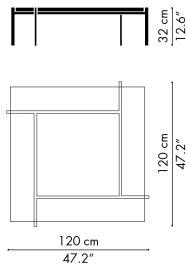
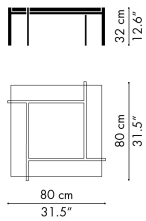



PK62™
POUL KJÆRHOLM 1968

11.2023

The PK62™ side table is available with a tabletop in slate, marble or granite. The base is made of satin brushed stainless steel.

MODEL	DESCRIPTION	SLATE	MARBLE	GRANITE	FAUSKE MARBLE	H/L/W
PK62	Side table, satin brushed stainless steel	2.065	2.065	2.065	2.395	17/80/27

MARBLE COLOUR - SEE THE SURFACE SELECTION
 WHITE (ROLLED)

FAUSKE MARBLE - SEE THE SURFACE SELECTION
 GREY-WHITE (ROLLED)

NOTE
 THE MARBLE TABLETOPS ARE ALL UNIQUE WITH THEIR OWN PATTERN.

PK62

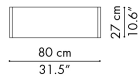



PK63™/PK63A™
POUL KJÆRHOLM 1968

11.2023

The PK63™ and PK63A™ coffee tables are available with a tabletop in slate, marble or granite. The base is made of satin brushed stainless steel.

MODEL	DESCRIPTION	SLATE	MARBLE	GRANITE	FAUSKE MARBLE	H/L/W
PK63	Coffee table, satin brushed stainless steel base	4.379	4.379	4.379	5.288	31/180/60
PK63A	Coffee table, satin brushed stainless steel base	3.635	3.635	3.635	4.296	31/120/60

MARBLE COLOUR - SEE THE SURFACE SELECTION
 WHITE (ROLLED)

FAUSKE MARBLE - SEE THE SURFACE SELECTION
 GREY-WHITE (ROLLED)

NOTE
 THE MARBLE TABLETOPS ARE ALL UNIQUE WITH THEIR OWN PATTERN.

PK63

PK63A

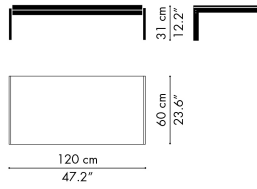
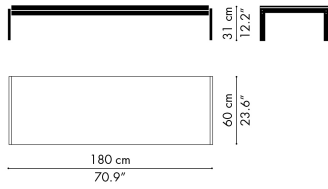



PK65™
POUL KJÆRHOLM 1979

11.2023

The PK65™ coffee table is available with a tabletop in slate, marble, granite and glass. The base is made of satin brushed stainless steel.

MODEL	DESCRIPTION	SLATE	MARBLE	GRANITE	GLASS	FAUSKE MARBLE	H/L/W
PK65	Coffee table, satin brushed stainless steel base	4.379	4.379	4.379	5.205	5.205	38/100/100

MARBLE COLOUR - SEE THE SURFACE SELECTION
 WHITE (ROLLED)

FAUSKE MARBLE - SEE THE SURFACE SELECTION
 GREY-WHITE (ROLLED)

NOTE
 THE MARBLE TABLETOPS ARE ALL UNIQUE WITH THEIR OWN PATTERN.

PK65

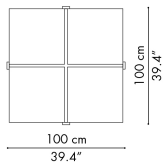

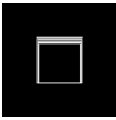

PK71™
POUL KJÆRHOLM 1957

11.2023

The PK71™ nesting table consists of three tables with a white or black acrylic tabletop. The bases are made of satin brushed stainless steel.

MODEL	DESCRIPTION	WHITE, BLACK	H/L/W
PK71	Nesting table, 3 sizes, satin brushed stainless steel base	1.900	28.5/28/28

PK71

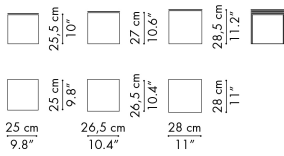

SURFACE SELECTION

SURFACE SELECTION

INVENTORY

- 33 • Leather
- 34 • Wood
- 35 • Acrylic
 - Polyester Composite
 - Marble
- 36 • Granite
 - Slate
 - Glass
 - Metal
- 37 • Flag Halyard
 - Canvas
 - Wicker
 - French Cane

SURFACE SELECTION

Colours and materials may vary from the images shown.
Actual colour, gloss level and structure may vary.

LEATHER

Please note that leather is a natural material with natural variation in colour and surface structure. The presence of scars and marks from bites etc. on the leather may occur and are characteristics of genuine leather.

CUSTOMER'S OWN LEATHER (COL)

Customers can supply their own leather. Prices excluding leather as well as leather requirements can be given on inquiry. Please note that only very few types of leather/qualities are suitable. Fritz Hansen retains the right to reject the qualities we find unsuitable.

SPECIAL LEATHER COLOURS

On inquiry and at a surcharge, special leather colours may be available for the models available with leather upholstery.

AURA

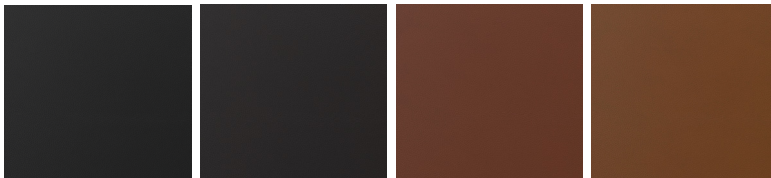

BLACK

BLACK BROWN

COGNAC

WALNUT

PK8™
PK9™
PK11™
PK20™
PK22™
PK24™
PK26™
PK31™
PK33™
PK40™
PK80™
PK81™
PK91™

CATEGORY: 4
Chrome-tanned, top-coated, strong full-grain and durable surface.
Fast to light.
Thickness 1.4-1.6 mm.

EMBRACE

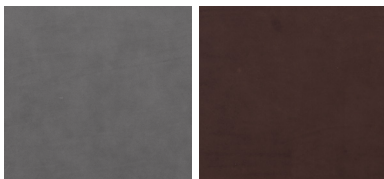

CONCRETE GREY

CHOCOLATE

PK9™
PK11™
PK20™
PK22™
PK24™
PK26™
PK31™
PK33™
PK40™
PK80™
PK81™
PK91™

CATEGORY: 5
Chrome-tanned, fully grained, extraordinary soft aniline with a special waxing giving a slightly 'oily' surface. Colour variations, visible natural markings e.g. Neck wrinkles.
Thickness 1.2-1.4 mm.

NATURAL



NATURAL

PK9™
PK11™
PK15™ (Seat cushion)
PK20™
PK22™
PK24™
PK26™
PK31™
PK33™
PK40™
PK80™
PK81™
PK91™

CATEGORY: 5
Vegetable-tanned, chrome-free, natural leather, no colour or protective finish. Becomes darker and patinated with use, visible natural markings.
Thickness 1.2-1.4 mm.

GRACE

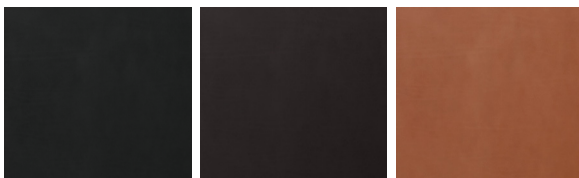

BLACK

DARK BROWN

WALNUT

PK4™ (Seat cushion)
PK9™
PK9™
PK11™
PK15™ (Seat cushion)
PK20™
PK22™
PK24™
PK26™
PK31™
PK33™
PK40™
PK80™
PK81™
PK91™

CATEGORY: 5
Vegetable and chrome-tanned, aniline, full-grain with light structure and light impregnation. Becomes lighter and patinated with use, visible natural markings.
Thickness 1.2-1.4 mm.

RUSTIK

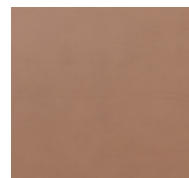

RUSTIK

PK9™
PK11™
PK20™
PK22™
PK24™
PK26™
PK31™
PK33™
PK40™
PK80™
PK81™
PK91™

CATEGORY: 5
Vegetable-tanned, chrome-free, aniline, no protective finish, light impregnation, visible natural marks. Becomes lighter and patinated with use.
Thickness 1.2-1.4 mm.

SURFACE SELECTION

Colours and materials may vary from the images shown.
Actual colour, gloss level and structure may vary.

CLEAR LACQUERED VENEER



ASH
PK51™
PK55™



OREGON PINE
PK0 A™
PK60™

COLOURED VENEER



ASH - BLACK
PK0 A™
PK60™

CLEAR LACQUERED SOLID WOOD



ASH
PK11™
PK15™

UNTREATED SOLID WOOD



MAPLE
PK54A™ (Expansion ring)

COLOURED SOLID WOOD



ASH - BLACK
PK15™

SURFACE SELECTION

Colours and materials may vary from the images shown.
Actual colour, gloss level and structure may vary.

ACRYLIC

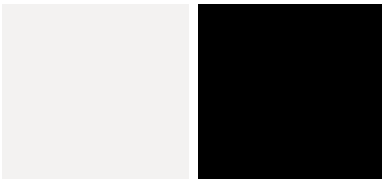

WHITE
PK71™

BLACK
PK71™

POLYESTER COMPOSITE

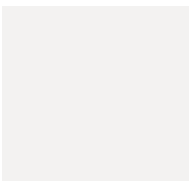

WHITE
PK58™

HONED MARBLE

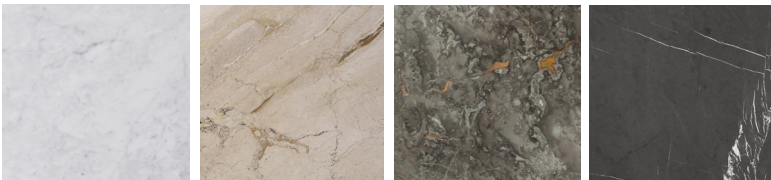

WHITE
PK54™
PK61™
PK61A™

BEIGE
PK54™
PK61™
PK61A™

GREY-BROWN
PK54™
PK61™
PK61A™

BLACK
PK54™
PK61™
PK61A™

ROLLED MARBLE

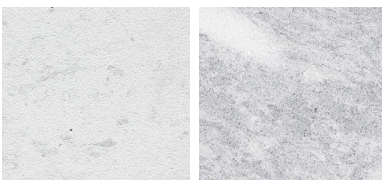

WHITE
PK54™
PK61™
PK61A™
PK62™
PK63™
PK63A™
PK65™

GREY-WHITE
PK54™
PK61™
PK61A™
PK62™
PK63™
PK63A™
PK65™

SURFACE SELECTION

Colours and materials may vary from the images shown.
Actual colour, gloss level and structure may vary.

GRANITE



DARK

PK54™
PK61™
PK61A™
PK62™
PK63™
PK63A™
PK65™

SLATE

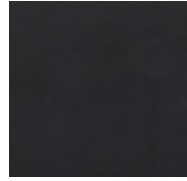

BLACK

PK61™
PK62™
PK63™
PK63A™
PK65™

GLASS



CLEAR

PK60™



FLOAT

PK61™
PK61A™
PK65™

STEEL



**BRUSHED SPRING
STEEL - MATT**

PK9™
PK11™
PK22™
PK24™
PK40™
PK51™
PK54™
PK55™
PK61™
PK61A™
PK62™
PK63™
PK63A™
PK65™
PK71™
PK80™
PK81™
PK91™



**BRUSHED STAINLESS
STEEL - MATT**

PK4™

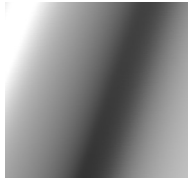

**CHROMED SPRING
STEEL - MATT**

PK20™
PK25™
PK26™
PK31™
PK33™

POWDER COATED METAL (STEEL OR ALUMINIUM)



BLACK

PK4™

SURFACE SELECTION

Colours and materials may vary from the images shown.
Actual colour, gloss level and structure may vary.

FLAG HALYARD

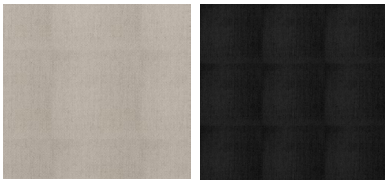

NATURAL
100% FLAX WITH
POLYESTER CORE

PK4™
PK25™

BLACK
100% FLAX WITH
POLYESTER CORE

PK4™
PK25™

CANVAS

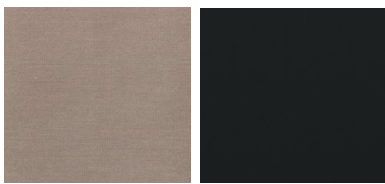

NATURAL
100% COTTON

PK4™ (Seat cushion)
PK22™
PK33™
PK80™
PK91™

BLACK
100% COTTON

PK4™ (Seat cushion)
PK22™
PK91™

WICKER



NATURAL
THICKNESS APPROX.
2.5 MM AND 4.0 MM

PK20™
PK22™
PK24™

FRENCH CANE

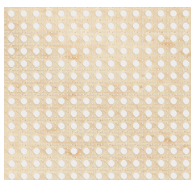

NATURAL

PK15™

PRICE LIST 2024

ACCESSORIES

EURO / VAT 21% / 11.2023

FRITZ HANSEN

CONTENT

03 • GENERAL TERMS AND CONDITIONS

CANDLEHOLDERS

- 05 • Candleholder Single
- 06 • Candleholder Large

CHILDREN'S CHAIRS

- 06 • Ant™ Children's Chair
- 07 • Grand Prix™ Children's Chair
- 08 • Lily™ Children's Chair
- 08 • Series 7™ Children's Chair
- 09 • Series 7™ Junior

COAT HOOKS & STANDS

- 10 • Coat Tree™
- 10 • Coat Tree™ Wall
- 11 • Happy Hook

CUSHIONS & THROWS

- 12 • Aiayu Cushion
- 12 • AJ Cushion
- 15 • Seat Cushion
- 16 • Cashmere Throw
- 16 • Classic Throw
- 16 • Jaime Hayon Throw

MIRRORS

- 16 • Mirror Long
- 17 • Mirror Oval
- 17 • Mirror Round

POUFS

- 17 • Pouf Large
- 18 • Pouf Small

RUGS & MATS

- 19 • Rugs

SIDE TABLES

- 20 • AJ Trolley™
- 20 • Tray Table
- 20 • Tray Table Large

STOOLS

- 21 • Dot™
- 22 • High Dot™ Counter Stool
- 24 • High Dot™ Bar Stool

STORE & ORGANIZE

- 25 • Basket
- 25 • JH Tray

VASES & POTS

- 25 • Ikebana Large
- 26 • Ikebana Small
- 26 • Ikebana Long
- 27 • Ikeru High
- 27 • Ikeru Low
- 28 • Moon Eye Vase

OTHER

- 28 • Miniature Egg™
- 29 • Miniature Swan™
- 29 • Miniature Series 7™
- 30 • Rocking Horse

SKAGERAK COLLECTION

COAT HOOKS & STANDS

- 32 • Collar Hanger
- 32 • Pilot Coat Hanger

CUTTING BOARDS & TRAYS

- 33 • Fionia Tray
- 34 • Norr Tray
- 34 • Nomad Table Tray
- 34 • Nomad Tray
- 35 • Dania Cutting Board
- 36 • Nordic Serving Tray
- 37 • No. 10 Tray
- 37 • Sild Tray
- 38 • Norr Carrier

KITCHEN ACCESSORIES

- 38 • Norr Paper Towel Holder
- 39 • Hammer Grinder

MIRRORS

- 39 • Aino Mirror

RUGS & MATS

- 40 • Dania Mat

STOOLS

- 40 • Dania Stool

STORE & ORGANIZE

- 40 • Dania Box
- 41 • Dania Letter Tray
- 41 • Nomad Pen Holder
- 42 • Nomad Letter Tray
- 42 • Nomad Box

VASES & POTS

- 42 • Edge Pot

OTHER

- 44 • Stella Christmas Tree Base
- 44 • Beach Tennis

GENERAL TERMS AND CONDITIONS

CURRENCY & EFFECTIVE DATE

This price list is valid from 1 November 2023 and cancels all prior price lists.

Reservation is made for any errors and omissions. Furthermore, below general terms and conditions shall apply to all contracts under which Fritz Hansen A/S (Fritz Hansen) is the supplier/sub-supplier.

ORDERING

Orders must be placed through Fritz Hansen's web-based order system called the Partner Portal (www.fritzhansen.com - professional). Orders are not binding until the customer has received a written order confirmation from Fritz Hansen.

Price lists state the recommended retail price (RRP) or prices excl. VAT exclusive of freight and fees. All prices can be changed without notice. Changes to the collection such as discontinued products and/or items out of stock can occur even when stated differently in the price list. Updated information will be available on the partner portal only.

ORDER CANCELLATION

Orders can be cancelled in accordance with the below rules:

	ORDERS CANCELLED 0-3 DAYS AFTER ORDER CONFIRMATION HAS BEEN SENT	ORDERS CANCELLED 3-14 DAYS AFTER ORDER CONFIRMATION HAS BEEN SENT
STANDARD PRODUCTS	FEE: NONE	FEE: 5% OF NET PRICE EXCL. VAT.
SPECIALS OR MODIFIED PRODUCTS	FEE: FULL PRICE	

Change and cancellation of order after 14 days from receipt of the order confirmation is not possible.

DELIVERY

The following freight rates apply:

RATE	PER ORDER
EU+UK+NO+CH+US*	DKK 200 / € 55 / £ 50 / SEK 600 / NOK 550 / USD 55 EXCL. VAT.
REST OF THE WORLD	TO BE PICKED UP AT FRITZ HANSEN WAREHOUSES

For markets EU+UK+NO+CH+US free freight offered according to the following rates: Free shipping from DKK 3.000 / € 400 / £ 350 / SEK 4.500 / NOK 4.000 / USD 500 total order value excl. VAT.

* For deliveries to outer areas such as islands in Portugal and Spain as well as Svalbard in Norway and others, a surcharge of DKK 420 / € 56 / £ 42 / NOK 580 per parcel will apply.

Standard delivery terms:

- Denmark: DDP delivery address (INCO-Terms 2020)
- Countries within the EU: DDP delivery address (INCO-Terms 2020)
- European countries outside the EU: DAP delivery address (INCO-Terms 2020)
- USA & Canada: DDP delivery address (INCO-Terms 2020)
- Japan: DDP delivery address (INCO-Terms 2020)
- South Korea: DAT Seoul Airport (INCO-Terms 2020)
- Middle East, Asia, South and Central America, Australia: FCA Fritz Hansen warehouses in Denmark and Poland (INCO-Terms 2020)

For FCA: The goods must be picked up at the Fritz Hansen warehouses no later than 30 calendar days after the confirmed shipping date of the consolidated order. Address(es) for pickup will be specified on the commercial invoice. If the goods are not picked up, Fritz Hansen will charge the customer DKK 24 / € 3 / USD 4 per day per pallet.

If the partner so desires, Fritz Hansen can deliver at the end user's address against an additional fee.

CLAIMS

The physical product must be inspected upon delivery. Damage incurred in transit as well as any defects and deficiencies on the product incurred as a result of transportation must be recorded on the POD upon delivery. Fritz Hansen must be notified in writing of any claims about product defects and deficiencies within 48 hours of delivery. If the claims are made in due time and with the acceptance of Fritz Hansen, the customer is entitled to demand a replacement delivery or to have the defect remedied. The customer cannot demand a reduction or a compensation. Claims/replacements can only be made to the customer's address if delivery has not been made directly to the end user.

TERMS OF PAYMENT

Terms of payment are 30 days net cash from invoice date. Invoices are issued and dated when the goods are dispatched. In case of late payment, interest will be charged at a rate of 1.5 % for every month or part thereof as from the due date. Interest invoices are payable net cash within eight days. Fritz Hansen can decide that the customer shall pay in advance, if the customer's balance is or has previously been due, or if the order amount exceeds the credit limit approved by Fritz Hansen.

OBSERVATION OF TITLE

Title to the goods shall not pass to the customer until Fritz Hansen (or any third party to whom Fritz Hansen has assigned its rights to the purchase price) has received the full purchase price and been reimbursed any expenses incurred.

WARRANTY

Fritz Hansen provides a standard five-year warranty on standard products within the collections Furniture and Skagerak Collection (Indoor & Outdoor) against defects in materials and workmanship. For the Arne Jacobsen shell chairs (Ant™, Grand Prix™, Lily™, Series 7™), the standard warranty is 10 years. Within the Furniture collection, an extended warranty of up to 10 years is provided on selected products, provided they have been registered online on www.fritzhansen.com/my-fh (see table on the next page for details).

For the Poul Kjærholm collection, the standard warranty is 20 years except for PK0 A™ and PK60™, which is 10 years, and the PK15™, which is 5 years. Wicker and French Cane have a warranty of 2 years.

For the Lighting, Accessories and Skagerak Collection Accessories the standard warranty is 2 years. Specific for the Lighting category: Transformers, ballasts, light sources, and other electronic devices are subject to the warranty terms of the manufacturer in question. Fritz Hansen does not cover costs related to installation and dismantling, replacement of ballasts/transformers and other similar costs related to electricians and the like.

The warranty on all collections does not extend to ordinary tear, wear or damage to upholstery. On any material, textile, or leather which is not listed in our price lists configured on a specific product, the standard warranty is 2 years. The warranty is void upon subsequent changes to the product.

Additional warranty conditions can be found on www.fritzhansen.com.

LIMITATION OF LIABILITY

Fritz Hansen will assume no liability for any loss as a result of delays, defects or any other breach of contract, unless such loss was caused by gross negligence on the part of Fritz Hansen. Fritz Hansen will assume no liability for any indirect loss, including loss of profits, operating loss, goodwill, loss of customers, running costs or any other consequential economic loss.

CHOICE OF LAW AND JURISDICTION

Disputes between Fritz Hansen and its customers shall be subject to Danish law, except for the international civil law rules of Danish law, and shall be settled by Fritz Hansen's home court.

MEASUREMENTS

The stated measurements act only as a guideline. The measurements can vary, and size difference on a product can occur.

FORCE MAJURE

Fritz Hansen is without liability for non-performance of Fritz Hansen's obligations in respect to any orders received, if such non-performance is due to circumstances out of Fritz Hansen's reasonable control, which prevent the fulfilment of the purchase agreement or makes the fulfilment unreasonably burdensome. As examples of such circumstances the following can be mentioned: Industrial dispute and other circumstances which are beyond the control of the parties, such as fire, war, mobilization or calling in for military service of similar extent, requisition, seizure, exchange controls, riots or disturbances, shortage of means of transportation, ordinary scarcity of goods, restrictions of motive power and defects in or late performance from sub-suppliers due to any of the aforementioned circumstances.

The above circumstances only lead to exemption from liability if their influence on the fulfilment of the purchase agreement could not be anticipated at the conclusion of the agreement. Fritz Hansen must without undue delay notify the customer in writing if any such circumstances, occurrence and cessation, if Fritz Hansen wishes to invoke any grounds of exemption from liability.

Regardless of what follows from these general conditions of sales and delivery, any party is entitled to terminate the purchase agreement by notifying the other party in writing, if the fulfilment of the agreement is prevented for more than 6 months due to one of the above circumstances.

Unless mandatory rules preclude this, Fritz Hansen is in no case liable to the customer for operating losses, lost earnings, or other financial consequential damages under these general conditions for sale and delivery.

PRIVACY POLICY

At Fritz Hansen, confidentiality and data protection is a high priority. Guidelines for processing of personal data and description of the customer's and end users' rights according to applicable data protection law is governed by Fritz Hansen's privacy policy available on Fritz Hansen's website.

WARRANTY OVERVIEW

Price list collections	Furniture Collection						Poul Kjærholm Collection				Skagerak Collection		Lighting Collection	Accessories Collection					
	Textile, Cushions	Leather (1)	Leather (2)	Bases (3)	Bases (4)	Movable parts (5)	Ant [™] Grand Prix [™] , Lily [™] , Series 7 [™]	Shells, Tabletops	Tabletops (6)	China Chair [™]	French Cane, Wicker	PK15 [™]	PKO A [™] & PK60 [™]	Poul Kjærholm Collection	Outdoor	Indoor	Lighting	Accessories	Skagerak Collection
2 years										x							x	x	x
5 years	x	x		x		x		x			x			x	x				
10 years			x*		x*		x	x*				x**							
20 years									x**				x**						

1. Leather: Soft and Essential
2. Leather: Aura, Rustik, Natural, Grace and Embrace
3. Bases: Lacquered and Wooden (chairs), Powder coated (chairs and tables)
4. Bases: Aluminium, Chrome and Wooden (tables)
5. Moveable parts: Automatic return, Tilt, Height-adjustable, Swivel, Castors and Extension mechanism
6. Tabletops: Lacquer under tabletop, Lacquer on edges and Surface on tabletop

* Additional with registration on www.fritzhansen.com/my-fh

** Standard without registration

CANDLEHOLDER SINGLE #1 JAIME HAYON

DESCRIPTION	EXCL. VAT	INCL. VAT
Candleholder	65	79



MATERIALS: Lacquered solid brass
DIMENSIONS: Diameter 5 cm, height 10,5 cm
COLLI: 8
ITEM NO.: 840092



CANDLEHOLDER SINGLE #1 JAIME HAYON

DESCRIPTION	EXCL. VAT	INCL. VAT
Candleholder	65	79



MATERIALS: Stainless steel
DIMENSIONS: Diameter 5 cm, height 10,5 cm
COLLI: 8
ITEM NO.: 840089



CANDLEHOLDER SINGLE #2 JAIME HAYON

DESCRIPTION	EXCL. VAT	INCL. VAT
Candleholder	73	89



MATERIALS: Lacquered solid brass
DIMENSIONS: Diameter 4 cm, height 13 cm
COLLI: 8
ITEM NO.: 840091



CANDLEHOLDER SINGLE #2 JAIME HAYON

DESCRIPTION	EXCL. VAT	INCL. VAT
Candleholder	73	89



MATERIALS: Stainless steel
DIMENSIONS: Diameter 4 cm, height 13 cm
COLLI: 8
ITEM NO.: 840088



CANDLEHOLDER LARGE JAIME HAYON

DESCRIPTION	EXCL. VAT	INCL. VAT
Candleholder	180	219



MATERIALS: Stainless steel
 DIMENSIONS: Diameter 16 cm, height 20 cm
 COLLI: 2
 ITEM NO.: 840087



CANDLEHOLDER LARGE JAIME HAYON

DESCRIPTION	EXCL. VAT	INCL. VAT
Candleholder	180	219



MATERIALS: Lacquered solid brass
 DIMENSIONS: Diameter 16 cm, height 20 cm
 COLLI: 2
 ITEM NO.: 840090



ANT™ CHILDREN'S CHAIR ARNE JACOBSEN

DESCRIPTION	EXCL. VAT	INCL. VAT
Children's chair	263	319

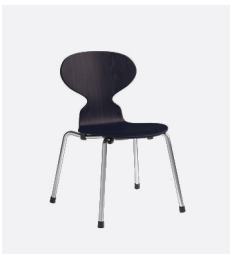

MATERIALS: Coloured ash veneer, chromed steel
 COLOUR: Midnight blue
 DIMENSIONS: Width 40 cm, height 60 cm, seat height 34 cm
 COLLI: 1
 ITEM NO.: 840224



ANT™ CHILDREN'S CHAIR ARNE JACOBSEN

DESCRIPTION	EXCL. VAT	INCL. VAT
Children's chair	263	319

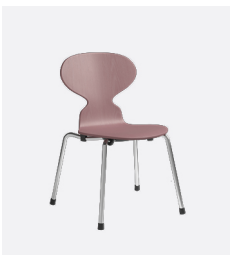

MATERIALS: Coloured ash veneer, chromed steel
 COLOUR: Wild Rose
 DIMENSIONS: Width 40 cm, height 60 cm, seat height 34 cm
 COLLI: 1
 ITEM NO.: 840225



ANT™ CHILDREN'S CHAIR ARNE JACOBSEN

DESCRIPTION	EXCL. VAT	INCL. VAT
Children's chair	263	319

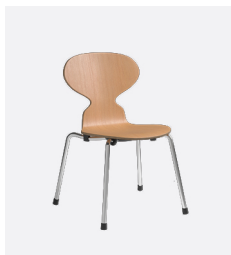

MATERIALS: Coloured ash veneer, chromed steel
COLOUR: Oregon Pine
DIMENSIONS: Width 40 cm, height 60 cm, seat height 34 cm
COLLI: 1
ITEM NO.: 840226



GRAND PRIX™ CHILDREN'S CHAIR ARNE JACOBSEN

DESCRIPTION	EXCL. VAT	INCL. VAT
Children's chair	263	319

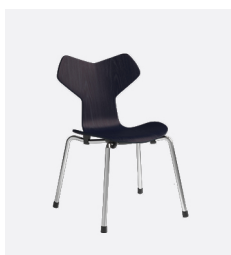

MATERIALS: Coloured ash veneer, chromed steel
COLOUR: Midnight blue
DIMENSIONS: Width 40 cm, height 60 cm, seat height 34 cm
COLLI: 1
ITEM NO.: 840221



GRAND PRIX™ CHILDREN'S CHAIR ARNE JACOBSEN

DESCRIPTION	EXCL. VAT	INCL. VAT
Children's chair	263	319

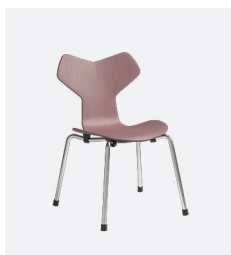

MATERIALS: Coloured ash veneer, chromed steel
COLOUR: Wild Rose
DIMENSIONS: Width 40 cm, height 60 cm, seat height 34 cm
COLLI: 1
ITEM NO.: 840222



GRAND PRIX™ CHILDREN'S CHAIR ARNE JACOBSEN

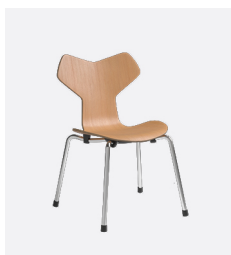

DESCRIPTION	EXCL. VAT	INCL. VAT
Children's chair	263	319





MATERIALS: Coloured ash veneer, chromed steel
COLOUR: Oregon Pine
DIMENSIONS: Width 40 cm, height 60 cm, seat height 34 cm
COLLI: 1
ITEM NO.: 840223





LILY™ CHILDREN'S CHAIR ARNE JACOBSEN

DESCRIPTION		EXCL. VAT	INCL. VAT
Children's chair		263	319
	<p>MATERIALS: Coloured ash veneer, chromed steel COLOUR: Midnight blue DIMENSIONS: Width 40 cm, height 60 cm, seat height 34 cm COLLI: 1 ITEM NO.: 840241</p>	 5 702370 002091	



LILY™ CHILDREN'S CHAIR ARNE JACOBSEN

DESCRIPTION		EXCL. VAT	INCL. VAT
Children's chair		263	319
	<p>MATERIALS: Coloured ash veneer, chromed steel COLOUR: Wild Rose DIMENSIONS: Width 40 cm, height 60 cm, seat height 34 cm COLLI: 1 ITEM NO.: 840242</p>	 5 702370 002107	

LILY™ CHILDREN'S CHAIR ARNE JACOBSEN

DESCRIPTION		EXCL. VAT	INCL. VAT
Children's chair		263	319
	<p>MATERIALS: Coloured ash veneer, chromed steel COLOUR: Midnight blue DIMENSIONS: Width 40 cm, height 60 cm, seat height 34 cm COLLI: 1 ITEM NO.: 840243</p>	 5 702370 002114	

SERIES 7™ CHILDREN'S CHAIR ARNE JACOBSEN

DESCRIPTION		EXCL. VAT	INCL. VAT
Children's chair		263	319
	<p>MATERIALS: Coloured ash veneer, chromed steel COLOUR: Midnight blue DIMENSIONS: Width 40 cm, height 60 cm, seat height 34 cm COLLI: 1 ITEM NO.: 840227</p>	 5 702370 002077	

SERIES 7™ CHILDREN'S CHAIR ARNE JACOBSEN

DESCRIPTION	EXCL. VAT	INCL. VAT
Children's chair	263	319



MATERIALS: Coloured ash veneer, chromed steel
 COLOUR: Wild Rose
 DIMENSIONS: Width 40 cm, height 60 cm, seat height 34 cm
 COLLI: 1
 ITEM NO.: 840228



SERIES 7™ CHILDREN'S CHAIR ARNE JACOBSEN

DESCRIPTION	EXCL. VAT	INCL. VAT
Children's chair	263	319

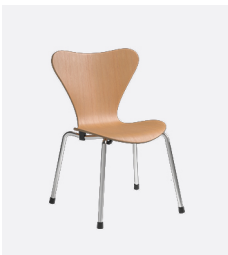

MATERIALS: Coloured ash veneer, chromed steel
 COLOUR: Oregon Pine
 DIMENSIONS: Width 40 cm, height 60 cm, seat height 34 cm
 COLLI: 1
 ITEM NO.: 840229



SERIES 7™ JUNIOR ARNE JACOBSEN

DESCRIPTION	EXCL. VAT	INCL. VAT
Junior chair	313	379

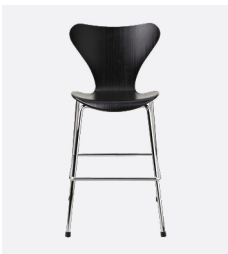

MATERIALS: Coloured ash veneer, chromed steel
 COLOUR: Black
 DIMENSIONS: Width 42 cm, depth 44 cm, height 79 cm, seat height 52 cm
 COLLI: 1
 ITEM NO.: 840236



SERIES 7™ JUNIOR Arne Jacobsen



DESCRIPTION	EXCL. VAT	INCL. VAT
Junior chair	313	379





MATERIALS: Natural oak veneer, chromed steel
 COLOUR: Oak
 DIMENSIONS: Width 42 cm, depth 44 cm, height 79 cm, seat height 52 cm
 COLLI: 1
 ITEM NO.: 840237





SERIES 7™ JUNIOR ARNE JACOBSEN

DESCRIPTION		EXCL. VAT	INCL. VAT
Junior Chair		313	379
	<p>MATERIALS: Coloured ash veneer, Brown Bronze powder coated steel COLOUR: Burnt Yellow DIMENSIONS: Width 42 cm, depth 44 cm, height 79 cm, seat height 52 cm COLLI: 1 ITEM NO.: 840238</p>	 5 702370 000301	



SERIES 7™ JUNIOR ARNE JACOBSEN

DESCRIPTION		EXCL. VAT	INCL. VAT
Junior Chair		313	379
	<p>MATERIALS: Coloured ash veneer, Brown Bronze powder coated steel COLOUR: Evergreen DIMENSIONS: Width 42 cm, depth 44 cm, height 79 cm, seat height 52 cm COLLI: 1 ITEM NO.: 840239</p>	 5 702370 000318	



COAT TREE™ SIDSE WERNER

DESCRIPTION		EXCL. VAT	INCL. VAT
Coat hanger		1.114	1.349
	<p>MATERIALS: Steel, plastic COLOUR: Chrome DIMENSIONS: Diameter 65 cm, height 193 cm COLLI: 1 ITEM NO.: 840332</p>	 5 702370 000646	



COAT TREE™ WALL SIDSE WERNER

DESCRIPTION		EXCL. VAT	INCL. VAT
Coat hanger		321	389
	<p>MATERIALS: Powder coated steel, plastic COLOUR: Light grey / grey knobs DIMENSIONS: Width 46 cm, length 30 cm, height 104 cm COLLI: 1 ITEM NO.: 840330 NOTE: Max load per arm: 8 kg. (Not responsible for how the product is mounted on the wall).</p>	 5 704890 403303	

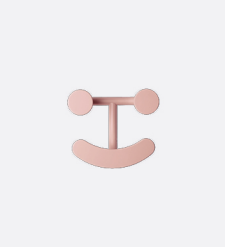

COAT TREE™ WALL SIDSE WERNER

DESCRIPTION		EXCL. VAT	INCL. VAT
Coat hanger		321	389
	<p>MATERIALS: Powder coated steel, plastic COLOUR: Dark blue / black knobs DIMENSIONS: Width 46 cm, length 30 cm, height 104 cm COLLI: 1 ITEM NO.: 840331 NOTE: Max load per arm: 8 kg. (Not responsible for how the product is mounted on the wall).</p>		 5 704890 403310



HAPPY HOOK Jaime Hayon

DESCRIPTION		EXCL. VAT	INCL. VAT
Hook		52	64
	<p>MATERIALS: Painted steel COLOUR: Blush DIMENSIONS: Width 15 cm, depth 6.5 cm, length 13 cm COLLI: 4 ITEM NO.: 850411</p>		 5 704890 504116

HAPPY HOOK Jaime Hayon

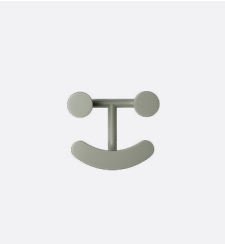

DESCRIPTION		EXCL. VAT	INCL. VAT
Hook		52	64
	<p>MATERIALS: Painted steel COLOUR: Turquoise DIMENSIONS: Width 15 cm, depth 6.5 cm, length 13 cm COLLI: 4 ITEM NO.: 850412</p>		 5 704890 504123

HAPPY HOOK Jaime Hayon

DESCRIPTION		EXCL. VAT	INCL. VAT
Hook		52	64
	<p>MATERIALS: Painted steel COLOUR: Green grey DIMENSIONS: Width 15 cm, depth 6.5 cm, length 13 cm COLLI: 4 ITEM NO.: 850413</p>		 5 704890 504130



HAPPY HOOK JAIME HAYON

DESCRIPTION	EXCL. VAT	INCL. VAT
Hook	98	119

	<p>MATERIALS: Brass COLOUR: Brass DIMENSIONS: Width 15 cm, depth 6.5 cm, length 13 cm COLLI: 4 ITEM NO.: 850421</p>	 5 702370 001063
--	---	--



CUSHION AIAYU

DESCRIPTION	EXCL. VAT	INCL. VAT
Cushion	123	149

	<p>MATERIALS: Baby llama wool and linen, down filling COLOUR: Anthracite DIMENSIONS: Width 60 cm, height 40 cm COLLI: 4 ITEM NO.: 840025</p>	 5 704890 400258
--	--	--

CUSHION AIAYU

DESCRIPTION	EXCL. VAT	INCL. VAT
Cushion	123	149

	<p>MATERIALS: Baby llama wool and linen, down filling COLOUR: Oat DIMENSIONS: Width 60 cm, height 40 cm COLLI: 4 ITEM NO.: 840026</p>	 5 704890 400265
--	---	--



CUSHION VERTIGO ARNE JACOBSEN

DESCRIPTION	EXCL. VAT	INCL. VAT
Cushion	123	149

	<p>MATERIALS: Wool, Fossflakes™ filling COLOUR: Light grey DIMENSIONS: Width 50 cm, height 50 cm COLLI: 4 PATTERN: Vertigo ITEM NO.: 840012</p>	 5 704890 400128
--	--	--

CUSHION VERTIGO ARNE JACOBSEN

DESCRIPTION	EXCL. VAT	INCL. VAT
Cushion	123	149

	<p>MATERIALS: Wool, Fossflakes™ filling COLOUR: Light grey DIMENSIONS: Width 60 cm, height 40 cm COLL: 4 PATTERN: Vertigo ITEM NO.: 840022</p>	 5 704890 400227
--	--	--

CUSHION TRAPEZ ARNE JACOBSEN

DESCRIPTION	EXCL. VAT	INCL. VAT
Cushion	123	149

	<p>MATERIALS: Wool, Fossflakes™ filling COLOUR: Midnight blue DIMENSIONS: Width 50 cm, height 50 cm COLL: 4 PATTERN: Trapez ITEM NO.: 840019</p>	 5 704890 400197
--	--	--

CUSHION TRAPEZ ARNE JACOBSEN

DESCRIPTION	EXCL. VAT	INCL. VAT
Cushion	123	149



	<p>MATERIALS: Wool, Fossflakes™ filling COLOUR: Midnight blue DIMENSIONS: Width 60 cm, height 40 cm COLL: 4 PATTERN: Trapez ITEM NO.: 840029</p>	 5 704890 400296
--	--	--

CUSHION TRAPEZ ARNE JACOBSEN

DESCRIPTION	EXCL. VAT	INCL. VAT
Cushion	123	149

	<p>MATERIALS: Wool, Fossflakes™ filling COLOUR: Earth Brown DIMENSIONS: Width 50 cm, height 50 cm COLL: 4 PATTERN: Trapez ITEM NO.: 840425</p>	 5 704890 404256
--	--	--



CUSHION TRAPEZ ARNE JACOBSEN

DESCRIPTION		EXCL. VAT	INCL. VAT
Cushion		123	149
 <p> MATERIALS: Wool, Fossflakes™ filling COLOUR: Earth Brown DIMENSIONS: Width 60 cm, height 40 cm COLL: 4 PATTERN: Trapez ITEM NO.: 840426 </p>			 5 704890 404263

CUSHION VERTIGO ARNE JACOBSEN

DESCRIPTION		EXCL. VAT	INCL. VAT
Cushion		123	149
 <p> MATERIALS: Wool, Fossflakes™ filling COLOUR: Sand DIMENSIONS: Width 50 cm, height 50 cm COLL: 4 PATTERN: Vertigo ITEM NO.: 840427 </p>			 5 704890 404270



CUSHION VERTIGO ARNE JACOBSEN

DESCRIPTION		EXCL. VAT	INCL. VAT
Cushion		123	149
 <p> MATERIALS: Wool, Fossflakes™ filling COLOUR: Sand DIMENSIONS: Width 60 cm, height 40 cm COLL: 4 PATTERN: Vertigo ITEM NO.: 840428 </p>			 5 704890 404287



CUSHION TASSEL ARNE JACOBSEN

DESCRIPTION		EXCL. VAT	INCL. VAT
Cushion		114	139
 <p> MATERIALS: Wool, Fossflakes™ filling COLOUR: Pale Green DIMENSIONS: Width 45 cm, height 45 cm COLL: 4 PATTERN: Tassel ITEM NO.: 840429 </p>			 5 704890 404294



CUSHION TASSEL ARNE JACOBSEN

DESCRIPTION		EXCL. VAT	INCL. VAT
Cushion		114	139
	<p>MATERIALS: Wool, Fossflakes™ filling COLOUR: Pale Green DIMENSIONS: Width 56 cm, height 36 cm COLLI: 4 PATTERN: Tassel ITEM NO.: 840430</p>		 5 704890 404300



SEAT CUSHION FRITZ HANSEN

DESCRIPTION		EXCL. VAT	INCL. VAT
Seat cushion		98	119
	<p>MATERIALS: Wild leather COLOUR: Walnut DIMENSIONS: Width 49 cm, length 39 cm. COLLI: 4 ITEM NO.: 840161</p>		 5 704890 401613



SEAT CUSHION FRITZ HANSEN

DESCRIPTION		EXCL. VAT	INCL. VAT
Seat cushion		65	79
	<p>MATERIALS: Raw leather COLOUR: Black DIMENSIONS: Width 49 cm, length 39 cm. COLLI: 12 ITEM NO.: 840160</p>		 5 704890 401606



SEAT CUSHION FRITZ HANSEN

DESCRIPTION		EXCL. VAT	INCL. VAT
Seat cushion		65	79
	<p>MATERIALS: Intense leather COLOUR: Brown DIMENSIONS: Width 49 cm, length 39 cm. COLLI: 12 ITEM NO.: 840162</p>		 5 704890 401620



CASHMERE THROW FRITZ HANSEN

DESCRIPTION		EXCL. VAT	INCL. VAT
Throw		346	419
	MATERIALS: 80% Cashmere, 20% Superfine Merino wool COLOUR: Natural brown DIMENSIONS: Width 120 cm, Length 190 cm COLLI: 2 ITEM NO.: 840002		 5 704890 400029



CLASSIC THROW FRITZ HANSEN

DESCRIPTION		EXCL. VAT	INCL. VAT
Throw		123	149
	MATERIALS: 100% fine Merino wool COLOUR: Grey DIMENSIONS: Width 130, length 180 cm COLLI: 2 ITEM NO.: 840007		 5 704890 400074



JAIME HAYON THROW JAIME HAYON

DESCRIPTION		EXCL. VAT	INCL. VAT
Throw		263	319
	MATERIALS: 45% Cotton, 35% Superfine Merino wool, 20% Alpaca COLOUR: Gold DIMENSIONS: Width 130 cm, length 200 cm COLLI: 2 ITEM NO.: 840004		 5 704890 400043



MIRROR LONG STUDIO ROSO

DESCRIPTION		EXCL. VAT	INCL. VAT
Mirror		866	1.049
	MATERIALS: Printed reflective glass, lacquered MDF COLOUR: Pink DIMENSIONS: Width 38 cm, height 161 cm COLLI: 1 ITEM NO.: 840300		 5 704890 403006



MIRROR OVAL STUDIO ROSO

DESCRIPTION		EXCL. VAT	INCL. VAT
Mirror		784	949
	MATERIALS: Printed reflective glass, lacquered MDF COLOUR: Ocean DIMENSIONS: Width 56 cm, height 84 cm COLLI: 1 ITEM NO.: 840310		 5 704890 403105



MIRROR ROUND STUDIO ROSO

DESCRIPTION		EXCL. VAT	INCL. VAT
Mirror		809	979
	MATERIALS: Printed reflective glass, lacquered MDF COLOUR: Green DIMENSIONS: Diameter 76 cm COLLI: 1 ITEM NO.: 840320		 5 704890 403204

POUF LARGE CECILIE MANZ

DESCRIPTION		EXCL. VAT	INCL. VAT
Pouf		428	519
	MATERIALS: Remix, canvas, leather piping COLOUR: Concrete DIMENSIONS: Diameter 60 cm, height 29 cm COLLI: 1 ITEM NO.: 840170		 5 704890 400890

POUF LARGE Cecilie Manz

DESCRIPTION		EXCL. VAT	INCL. VAT
Pouf		428	519
	MATERIALS: Wool, linen, leather piping COLOUR: Indigo DIMENSIONS: Diameter 60 cm, height 29 cm COLLI: 1 ITEM NO.: 840299		 5 704890 402993

POUF LARGE CECILIE MANZ

DESCRIPTION	EXCL. VAT	INCL. VAT
Pouf	428	519



MATERIALS: Twill weave, canvas, leather piping
COLOUR: Beige
DIMENSIONS: Diameter 60 cm, height 29 cm
COLLI: 1
ITEM NO.: 840421



POUF SMALL CECILIE MANZ

DESCRIPTION	EXCL. VAT	INCL. VAT
Pouf	470	569



MATERIALS: Buffed leather, canvas, leather piping
COLOUR: Grey
DIMENSIONS: Diameter 50 cm, height 24 cm
COLLI: 1
ITEM NO.: 840423



POUF SMALL Cecilie Manz

DESCRIPTION	EXCL. VAT	INCL. VAT
Pouf	362	439



MATERIALS: Hallingdal, canvas, leather piping
COLOUR: Ultramarine
DIMENSIONS: Diameter 50 cm, height 24 cm
COLLI: 1
ITEM NO.: 840298



POUF SMALL CECILIE MANZ



DESCRIPTION	EXCL. VAT	INCL. VAT
Pouf	362	439





MATERIALS: Remix, canvas, leather piping
COLOUR: Slate
DIMENSIONS: Diameter 50 cm, height 24 cm
COLLI: 1
ITEM NO.: 840178

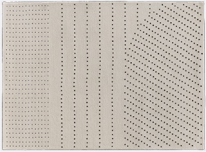

RUG DOTS Cecilie Manz

DESCRIPTION		EXCL. VAT	INCL. VAT
Rug		1.073	1.299
	<p>MATERIALS: 100% wool COLOUR: Beige / black DIMENSIONS: Width 150 cm, length 190 cm COLLI: 1 ITEM NO.: 840400</p>		 5 704890 404003

RUG BALANCE Cecilie Manz

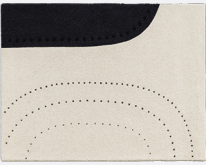

DESCRIPTION		EXCL. VAT	INCL. VAT
Rug		511	619
	<p>MATERIALS: 100% wool COLOUR: Black / beige / pale yellow DIMENSIONS: Width 103 cm, length 130 cm COLLI: 1 ITEM NO.: 840401</p>		 5 704890 404010

RUG DOTTED BALANCE Cecilie Manz



DESCRIPTION		EXCL. VAT	INCL. VAT
Rug		511	619
	<p>MATERIALS: 100% wool COLOUR: Beige / black DIMENSIONS: Width 103 cm, length 130 cm COLLI: 1 ITEM NO.: 840402</p>		 5 704890 404027

RUG OCHRE Cecilie Manz



DESCRIPTION		EXCL. VAT	INCL. VAT
Rug		511	619
	<p>MATERIALS: 100% wool COLOUR: Black / ochre / grey DIMENSIONS: Width 103 cm, length 130 cm COLLI: 1 ITEM NO.: 840403</p>		 5 704890 404034

DESCRIPTION		EXCL. VAT	INCL. VAT
Small table		676	819
	<p>MATERIALS: Brushed stainless steel, MDF, coloured ash veneer COLOUR: Black DIMENSIONS: Width 67 cm, depth 59 cm, height 54,7 cm COLLI: 1 ITEM NO.: 840410</p>		 5 704890 404102



TRAY TABLE FRITZ HANSEN

DESCRIPTION		EXCL. VAT	INCL. VAT
Foldable tray table		470	569
	<p>MATERIALS: Veneer, solid wood base, oiled oak COLOUR: Oak DIMENSIONS: Diameter 45 cm, height 42 cm COLLI: 2 ITEM NO.: 840120</p>		 5 704890 401200

TRAY TABLE FRITZ HANSEN

DESCRIPTION		EXCL. VAT	INCL. VAT
Foldable tray table		470	569
	<p>MATERIALS: Veneer, solid wood base, lacquered oak COLOUR: Black DIMENSIONS: Diameter 45 cm, height 42 cm COLLI: 2 ITEM NO.: 840121</p>		 5 704890 401217

TRAY TABLE LARGE FRITZ HANSEN

DESCRIPTION		EXCL. VAT	INCL. VAT
Foldable tray table		594	719
	<p>MATERIALS: Veneer, solid wood base, lacquered oak COLOUR: Black DIMENSIONS: Diameter 60 cm, height 39 cm COLLI: 2 ITEM NO.: 840122</p>		 5 704890 401224

TRAY TABLE LARGE Fritz Hansen

DESCRIPTION	EXCL. VAT	INCL. VAT
Foldable tray table	594	719



MATERIALS: Veneer, solid wood base, oiled oak
 COLOUR: Oak
 DIMENSIONS: Diameter 60 cm, height 39 cm
 COLLI: 2
 ITEM NO.: 840124



DOT™ ARNE JACOBSEN

DESCRIPTION	EXCL. VAT	INCL. VAT
Stool	222	269



MATERIALS: Walnut veneer, chromed base
 COLOUR: Walnut
 DIMENSIONS: Diameter 34 cm, height 46 cm
 COLLI: 1
 ITEM NO.: 840132



DOT™ ARNE JACOBSEN

DESCRIPTION	EXCL. VAT	INCL. VAT
Stool	222	269



MATERIALS: Colored ash, chromed base
 COLOUR: Black
 DIMENSIONS: Diameter 34 cm, height 46 cm
 COLLI: 1
 ITEM NO.: 840128



DOT™ ARNE JACOBSEN

DESCRIPTION	EXCL. VAT	INCL. VAT
Stool	271	329



MATERIALS: Wild leather, chromed steel
 COLOUR: Walnut
 DIMENSIONS: Diameter 34 cm, height 46 cm
 COLLI: 1
 ITEM NO.: 840100



DOT™ ARNE JACOBSEN

DESCRIPTION	EXCL. VAT	INCL. VAT
Stool	271	329



MATERIALS: Intense leather, powder-coated steel
 COLOUR: Black matt
 DIMENSIONS: Diameter 34 cm, height 46 cm
 COLLI: 1
 ITEM NO.: 840105



HIGH DOT™ COUNTER STOOL ARNE JACOBSEN

DESCRIPTION	EXCL. VAT	INCL. VAT
Counter Stool 3-Legs	354	429



MATERIALS: Intense leather, powder coated steel
 COLOUR: Black matt
 DIMENSIONS: Diameter 44 cm, height 65 cm
 COLLI: 1
 ITEM NO.: 840106



HIGH DOT™ COUNTER STOOL ARNE JACOBSEN

DESCRIPTION	EXCL. VAT	INCL. VAT
Counter Stool 3-Legs	354	429

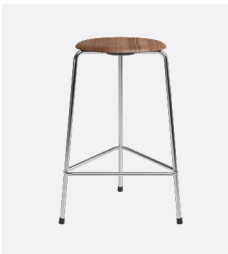

MATERIALS: Wild leather, chromed steel
 COLOUR: Walnut
 DIMENSIONS: Diameter 44 cm, height 65 cm
 COLLI: 1
 ITEM NO.: 840107



HIGH DOT™ COUNTER STOOL ARNE JACOBSEN

DESCRIPTION	EXCL. VAT	INCL. VAT
Counter Stool 3-Legs	304	369

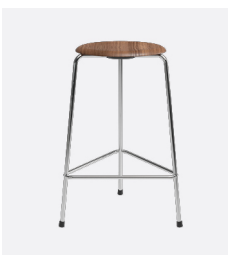

MATERIALS: Walnut veneer, chromed base
 COLOUR: Walnut
 DIMENSIONS: Diameter 34 cm, height 65 cm
 COLLI: 1
 ITEM NO.: 840133



HIGH DOT™ COUNTER STOOL ARNE JACOBSEN

DESCRIPTION	EXCL. VAT	INCL. VAT
Counter Stool 3-Legs	304	369



MATERIALS: Colored ash, chromed base
 COLOUR: Black
 DIMENSIONS: Diameter 34 cm, height 65 cm
 COLLI: 1
 ITEM NO.: 840129



HIGH DOT™ COUNTER STOOL ARNE JACOBSEN

DESCRIPTION	EXCL. VAT	INCL. VAT
Counter Stool 4-Legs	304	369



MATERIALS: Walnut veneer, chromed base
 COLOUR: Walnut
 DIMENSIONS: Diameter 34 cm, height 65 cm
 COLLI: 1
 ITEM NO.: 840134



HIGH DOT™ COUNTER STOOL ARNE JACOBSEN

DESCRIPTION	EXCL. VAT	INCL. VAT
Counter Stool 4-Legs	304	369



MATERIALS: Colored ash, chromed base
 COLOUR: Black
 DIMENSIONS: Diameter 34 cm, height 65 cm
 COLLI: 1
 ITEM NO.: 840130



HIGH DOT™ COUNTER STOOL ARNE JACOBSEN

DESCRIPTION	EXCL. VAT	INCL. VAT
Counter Stool 4-Legs	346	419



MATERIALS: Intense leather, black, powdercoated steel
 COLOUR: Black matt
 DIMENSIONS: Diameter 34 cm, height 65 cm
 COLLI: 1
 ITEM NO.: 840136



HIGH DOT™ COUNTER STOOL ARNE JACOBSEN

DESCRIPTION	EXCL. VAT	INCL. VAT
Counter Stool 4-Legs	346	419



MATERIALS: Wild leather, walnut, chromed steel
 COLOUR: Walnut
 DIMENSIONS: Diameter 34 cm, height 65 cm
 COLLI: 1
 ITEM NO.: 840138



HIGH DOT™ BAR STOOL ARNE JACOBSEN

DESCRIPTION	EXCL. VAT	INCL. VAT
Bar stool 4-legs	304	369



MATERIALS: Walnut veneer, chromed base
 COLOUR: Walnut
 DIMENSIONS: Diameter 34 cm, height 76 cm
 COLLI: 1
 ITEM NO.: 840135



HIGH DOT™ BAR STOOL ARNE JACOBSEN

DESCRIPTION	EXCL. VAT	INCL. VAT
Bar stool 4-legs	304	369



MATERIALS: Colored ash, chromed base
 COLOUR: Black
 DIMENSIONS: Diameter 34 cm, height 76 cm
 COLLI: 1
 ITEM NO.: 840131



HIGH DOT™ BAR STOOL ARNE JACOBSEN



DESCRIPTION	EXCL. VAT	INCL. VAT
Bar stool 4-legs	346	419





MATERIALS: Intense leather, black, powdercoated steel
 COLOUR: Black matt
 DIMENSIONS: Diameter 34 cm, height 76 cm
 COLLI: 1
 ITEM NO.: 840137





HIGH DOT™ BAR STOOL ARNE JACOBSEN

DESCRIPTION		EXCL. VAT	INCL. VAT
Bar stool 4-legs		346	419
	MATERIALS: Wild leather, walnut, chromed steel COLOUR: Walnut DIMENSIONS: Diameter 34 cm, height 76 cm COLL: 1 ITEM NO.: 840139		 5 702370 002275



BASKET BENJAMIN HUBERT

DESCRIPTION		EXCL. VAT	INCL. VAT
Basket		180	219
	MATERIALS: Lacquered ash veneer, steam bent ash DIMENSIONS: Width 37 cm, length 53 cm, height 36,5 cm COLL: 2 ITEM NO.: 840240		 5 704890 402405

JH TRAY JAIME HAYON

DESCRIPTION		EXCL. VAT	INCL. VAT
Tray		280	339
	MATERIALS: Oregon Pine, Brass DIMENSIONS: Diameter 38,5 cm, height 27 cm COLL: 4 ITEM NO.: 840431		 5 702370 000233

IKEBANA LARGE JAIME HAYON

DESCRIPTION		EXCL. VAT	INCL. VAT
Large vase		180	219
	MATERIALS: Handblown clear glass, brass plated stainless steel DIMENSIONS: Diameter 24 cm, height 15,5 cm COLL: 2 ITEM NO.: 840140		 5 704890 401408

IKEBANA LARGE JAIME HAYON

DESCRIPTION	EXCL. VAT	INCL. VAT
Large vase	180	219



MATERIALS: Handblown clear glass, stainless steel
DIMENSIONS: Diameter 24 cm, height 15,5 cm
COLLI: 2
ITEM NO.: 840147



IKEBANA SMALL JAIME HAYON

DESCRIPTION	EXCL. VAT	INCL. VAT
Small vase	98	119



MATERIALS: Handblown clear glass, stainless steel
DIMENSIONS: Diameter 12 cm, height 13 cm
COLLI: 4
ITEM NO.: 840146



IKEBANA SMALL JAIME HAYON

DESCRIPTION	EXCL. VAT	INCL. VAT
Small vase	98	119



MATERIALS: Handblown clear glass, brass plated stainless steel
DIMENSIONS: Diameter 12 cm, height 13 cm
COLLI: 4
ITEM NO.: 840141



IKEBANA LONG JAIME HAYON

DESCRIPTION	EXCL. VAT	INCL. VAT
Long vase	180	219



MATERIALS: Handblown clear glass, brass plated stainless steel
DIMENSIONS: Width 9,5 cm, length 33,5 cm, height 13 cm
COLLI: 2
ITEM NO.: 840142



IKEBANA LONG JAIME HAYON

DESCRIPTION	EXCL. VAT	INCL. VAT
Long vase	180	219



MATERIALS: Handblown clear glass, stainless steel
 DIMENSIONS: Width 9,5 cm, length 33,5 cm, height 13 cm
 COLLI: 2
 ITEM NO.: 840148



IKERU HIGH VASE Jaime Hayon

DESCRIPTION	EXCL. VAT	INCL. VAT
High vase	98	119



MATERIALS: Handblown glass, anodised aluminium
 COLOUR: Forest green
 DIMENSIONS: Diameter 16 cm, height: 23,9 cm
 COLLI: 4
 ITEM NO.: 840143



IKERU HIGH VASE JAIME HAYON

DESCRIPTION	EXCL. VAT	INCL. VAT
High vase	98	119



MATERIALS: Handblown glass, anodised aluminium
 COLOUR: Dusk blue
 DIMENSIONS: Diameter 16 cm, height: 23,9 cm
 COLLI: 4
 ITEM NO.: 840151



IKERU LOW VASE Jaime Hayon

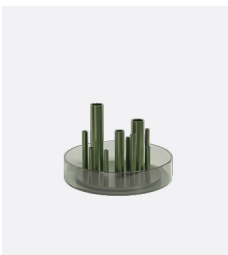

DESCRIPTION	EXCL. VAT	INCL. VAT
Low vase	114	139





MATERIALS: Handblown glass, anodised aluminium
 COLOUR: Forest green
 DIMENSIONS: Diameter 19 cm, height 13,1 cm
 COLLI: 4
 ITEM NO.: 840144

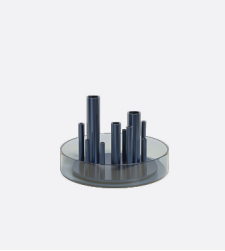



IKERU LOW VASE JAIME HAYON

DESCRIPTION		EXCL. VAT	INCL. VAT
Low Vase		114	139
	<p>MATERIALS: Handblown glass, anodised aluminium COLOUR: Dusk blue DIMENSIONS: Diameter 1.9 cm, height 13,1 cm COLLI: 4 ITEM NO.: 840152</p>		 5 702370 002152



MOON EYE VASE GRETHE MEYER

DESCRIPTION		EXCL. VAT	INCL. VAT
Vase set		147	179
	<p>MATERIALS: Moon: Clear glass Eye: Smoked and clear glass DIMENSIONS: Moon: Width 1.6 cm, depth 8 cm, height 23 cm Eye: Width 1.3,5 cm, depth 8 cm, height 16 cm COLLI: 2 ITEM NO.: 840270</p>		 5 704890 402702

MINIATURE EGG™ ARNE JACOBSEN

DESCRIPTION		EXCL. VAT	INCL. VAT
Miniature lounge chair		180	219
	<p>MATERIALS: Textile, chromed base COLOUR: Black DIMENSIONS: Width 13,5 cm, height 16,5 cm COLLI: 2 ITEM NO.: 840050</p>		 5 704890 400500

MINIATURE EGG™ ARNE JACOBSEN

DESCRIPTION		EXCL. VAT	INCL. VAT
Miniature lounge chair		180	219
	<p>MATERIALS: Textile, chromed base COLOUR: Red DIMENSIONS: Width 13,5 cm, height 16,5 cm COLLI: 2 ITEM NO.: 840051</p>		 5 704890 400517

MINIATURE SWAN™ ARNE JACOBSEN

DESCRIPTION	EXCL. VAT	INCL. VAT
Miniature lounge chair	139	169



MATERIALS: Textile, chromed base
 COLOUR: Black
 DIMENSIONS: Width 13,5 cm, height 9 cm
 COLLI: 2
 ITEM NO.: 840060



MINIATURE SWAN™ ARNE JACOBSEN

DESCRIPTION	EXCL. VAT	INCL. VAT
Miniature lounge chair	139	169

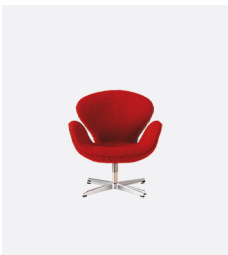

MATERIALS: Textile, chromed base
 COLOUR: Red
 DIMENSIONS: Width 13,5 cm, height 9 cm
 COLLI: 2
 ITEM NO.: 840061



MINIATURE SERIES 7™ ARNE JACOBSEN

DESCRIPTION	EXCL. VAT	INCL. VAT
Miniature chair	65	79

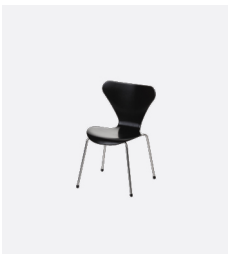

MATERIALS: Lacquered veneer, chromed base
 COLOUR: Black
 DIMENSIONS: Width 8,5 cm, height 13 cm
 COLLI: 4
 ITEM NO.: 840180



MINIATURE SERIES 7™ ARNE JACOBSEN

DESCRIPTION	EXCL. VAT	INCL. VAT
Miniature chair	65	79

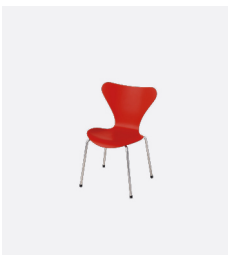

MATERIALS: Lacquered veneer, chromed base
 COLOUR: Opium red
 DIMENSIONS: Width 8,5 cm, height 13 cm
 COLLI: 4
 ITEM NO.: 840181



MINIATURE SERIES 7™ ARNE JACOBSEN

DESCRIPTION	EXCL. VAT	INCL. VAT
Miniature chair	65	79

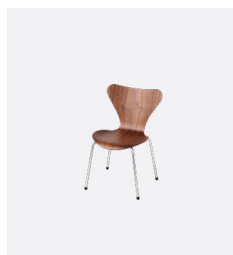

MATERIALS: Lacquered veneer, chromed base
COLOUR: Walnut
DIMENSIONS: Width 8,5 cm, height 13 cm
COLL: 4
ITEM NO.: 840182



ROCKING HORSE FRITZ HANSEN

DESCRIPTION	EXCL. VAT	INCL. VAT
Rocking Horse	693	839

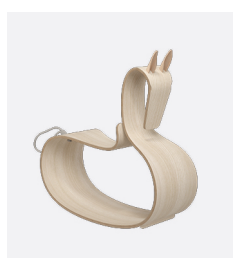

MATERIALS: Lacquered ash, harness leather, halyard
COLOUR: Clear lacquered
DIMENSIONS: Width 58,5 cm, depth 21 cm, height 60,5 cm
COLL: 1
ITEM NO.: 840432



ROCKING HORSE FRITZ HANSEN

DESCRIPTION	EXCL. VAT	INCL. VAT
Rocking Horse	693	839

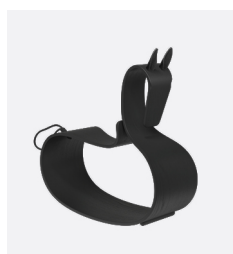

MATERIALS: Coloured ash, harness leather, halyard
COLOUR: Black
DIMENSIONS: Width 58,5 cm, depth 21 cm, height 60,5 cm
COLL: 1
ITEM NO.: 840433





SKAGERAK COLLECTION



COLLAR HANGER TAF

DESCRIPTION	EXCL. VAT	INCL. VAT
	36	44
 <p> MATERIALS: Oak, Stainless Steel DIMENSIONS: Length 43 cm, width 1,5 cm, height 22,5 cm COLLI: 1 ITEM NO.: 1431018 </p>		 5 706420 096108



COLLAR HANGER TAF

DESCRIPTION	EXCL. VAT	INCL. VAT
	36	44
 <p> MATERIALS: Oak, Aluminum COLOUR: Black DIMENSIONS: Length 43 cm, width 1,5 cm, height 22,5 cm COLLI: 1 ITEM NO.: 1431019 </p>		 5 706420 096122



COLLAR HANGER TAF

DESCRIPTION	EXCL. VAT	INCL. VAT
	36	44
 <p> MATERIALS: Teak, Stainless Steel DIMENSIONS: Length 43 cm, width 1,5 cm, height 22,5 cm COLLI: 1 ITEM NO.: 1431022 </p>		 5 706420 101154



PILOT COAT HANGER NINA TOLSTRUP

DESCRIPTION	EXCL. VAT	INCL. VAT
	57	69
 <p> MATERIALS: Oak, Stainless Steel DIMENSIONS: Length 43 cm, width 4 cm, height 21 cm COLLI: 3 ITEM NO.: S1600627 </p>		 5 706420 064695



PILOT COAT HANGER NINA TOLSTRUP

DESCRIPTION	EXCL. VAT	INCL. VAT
	57	69
 <p> MATERIALS: Oak, Stainless Steel COLOUR: Black DIMENSIONS: Length 43 cm, width 4 cm, height 21 cm COLL: 3 ITEM NO.: S1600628 </p>		 5 706420 064701



FIONIA TRAY SKAGERAK

DESCRIPTION	EXCL. VAT	INCL. VAT
	131	159
 <p> MATERIALS: Teak DIMENSIONS: Length 48 cm, width 32 cm, height 6 cm COLL: 1 ITEM NO.: S1600509 </p>		 5 706420 028925



FIONIA TRAY SKAGERAK

DESCRIPTION	EXCL. VAT	INCL. VAT
	131	159
 <p> MATERIALS: Oak DIMENSIONS: Length 48 cm, width 32 cm, height 6 cm COLL: 1 ITEM NO.: S1600588 </p>		 5 706420 034421



FIONIA TRAY SKAGERAK

DESCRIPTION	EXCL. VAT	INCL. VAT
	139	169
 <p> MATERIALS: Oak DIMENSIONS: Length 52 cm, width 36 cm, height 6 cm COLL: 1 ITEM NO.: 1600506 </p>		 5 706420 101246

FIONIA TRAY SKAGERAK

DESCRIPTION	EXCL. VAT	INCL. VAT
	139	169
 <p> MATERIALS: Teak DIMENSIONS: Lenght 52 cm, width 36 cm, height 6 cm COLLI: 1 ITEM NO.: S1600507 </p>		 5 706420 028901



NORR TRAY SKAGERAK

DESCRIPTION	EXCL. VAT	INCL. VAT
	81	99
 <p> MATERIALS: Oak, Leather DIMENSIONS: Lenght 46 cm, width 25,5 cm, height 2,5 cm COLLI: 1 ITEM NO.: S1930233 </p>		 5 706420 071051



NOMAD TABLE TRAY VE2

DESCRIPTION	EXCL. VAT	INCL. VAT
	189	229
 <p> MATERIALS: Oak, Steel COLOUR: Silk Grey DIMENSIONS: Lenght 60 cm, width 35 cm, height 22 cm COLLI: 1 ITEM NO.: 1930251 </p>		 5 706420 081647



NOMAD TRAY VE2

DESCRIPTION	EXCL. VAT	INCL. VAT
	65	79
 <p> MATERIALS: Oak DIMENSIONS: Lenght 42 cm, width 14 cm, height 3 cm COLLI: 1 ITEM NO.: S1930230 </p>		 5 706420 070924



NOMAD TRAY VE2

DESCRIPTION	EXCL. VAT	INCL. VAT
	48	59
 <p> MATERIALS: Oak DIMENSIONS: Length 23,5 cm, width 14 cm, height 2,5 cm COLL: 1 ITEM NO.: S1930241 </p>		 5 706420 074069



DANIA CUTTING BOARD SKAGERAK

DESCRIPTION	EXCL. VAT	INCL. VAT
	69	84
 <p> MATERIALS: Teak End Grain DIMENSIONS: Length 33 cm, width 21 cm, height 2,5 cm COLL: 6 ITEM NO.: S1990891 </p>		 706420 049067



DANIA CUTTING BOARD SKAGERAK

DESCRIPTION	EXCL. VAT	INCL. VAT
	98	119
 <p> MATERIALS: Teak End Grain DIMENSIONS: Length 35 cm, width 24 cm, height 4 cm COLL: 4 ITEM NO.: S1990845 </p>		 5 706420 030201



DANIA CUTTING BOARD SKAGERAK

DESCRIPTION	EXCL. VAT	INCL. VAT
	98	119
 <p> MATERIALS: Teak End Grain DIMENSIONS: Length 40 cm, width 24 cm, height 2,5 cm COLL: 4 ITEM NO.: S1990844 </p>		 5 706420 070160

DANIA CUTTING BOARD SKAGERAK

DESCRIPTION	EXCL. VAT	INCL. VAT
	114	139
 <p> MATERIALS: Teak End Grain DIMENSIONS: Length 50 cm, width 27 cm, height 3 cm COLL: 4 ITEM NO.: S1990847 </p>		 5 706420 030218

DANIA CUTTING BOARD SKAGERAK

DESCRIPTION	EXCL. VAT	INCL. VAT
	214	259
 <p> MATERIALS: Teak End Grain DIMENSIONS: Length 56 cm, width 35 cm, height 4 cm COLL: 1 ITEM NO.: S1990890 </p>		 5 706420 047131

NORDIC SERVING TRAY VE2



DESCRIPTION	EXCL. VAT	INCL. VAT
	131	159
 <p> MATERIALS: Oak DIMENSIONS: Diameter 30 cm, height 3,5 cm COLL: 1 ITEM NO.: 1600315 </p>		 5 706420 080961

NORDIC SERVING TRAY VE2

DESCRIPTION	EXCL. VAT	INCL. VAT
	205	249
 <p> MATERIALS: Oak DIMENSIONS: Diameter 45 cm, height 3,5 cm COLL: 1 ITEM NO.: 1600316 </p>		 5 706420 080947



NO. 10 TRAY LARGE TERUHIRO YANAGIHARA

DESCRIPTION	EXCL. VAT	INCL. VAT
	106	129

	<p>MATERIALS: Oak DIMENSIONS: Length 53,5 cm, width 34 cm, height 3,5 cm COLLI: 1 ITEM NO.: 1600496</p>	 5 706420 104315
--	--	--

NO. 10 TRAY MEDIUM TERUHIRO YANAGIHARA

DESCRIPTION	EXCL. VAT	INCL. VAT
	98	119

	<p>MATERIALS: Oak DIMENSIONS: Length 45 cm, width 32 cm, height 3,5 cm COLLI: 1 ITEM NO.: 1600495</p>	 5 706420 104308
--	--	--



NO. 10 TRAY SMALL TERUHIRO YANAGIHARA

DESCRIPTION	EXCL. VAT	INCL. VAT
	77	94



	<p>MATERIALS: Oak DIMENSIONS: Length 36,5 cm, width 30 cm, height 3,5 cm COLLI: 1 ITEM NO.: 1600494</p>	 5 706420 104292
--	--	--

SILD TRAY SØREN REFSGAARD



DESCRIPTION	EXCL. VAT	INCL. VAT
	131	159

	<p>MATERIALS: Teak DIMENSIONS: Length 55 cm, width 16 cm, height 1,5 cm COLLI: 1 ITEM NO.: 1600973</p>	 5 706420 087267
--	---	--

SILD TRAY SØREN REFSGAARD

DESCRIPTION	EXCL. VAT	INCL. VAT
	156	189
 <p>MATERIALS: Teak DIMENSIONS: Length 49 cm, width 24,5 cm, height 1,5 cm COLLI: 1 ITEM NO.: 1600971</p>		 5 706420 081142



NORR CARRIER DITTE BUUS NIELSEN

DESCRIPTION	EXCL. VAT	INCL. VAT
	114	139
 <p>MATERIALS: Oak, Brass Plated Steel DIMENSIONS: Length 22 cm, width 15,5 cm, height 20,5 cm COLLI: 1 ITEM NO.: 1930237</p>		 5 706420 087007



NORR PAPER TOWEL HOLDER DITTE BUUS NIELSEN

DESCRIPTION	EXCL. VAT	INCL. VAT
	69	84
 <p>MATERIALS: Oak, Leather COLOUR: Black DIMENSIONS: Diameter 14 cm, height 30,5 cm COLLI: 2 ITEM NO.: 1930261</p>		 5 706420 089803



NORR PAPER TOWEL HOLDER DITTE BUUS NIELSEN

DESCRIPTION	EXCL. VAT	INCL. VAT
	65	79
 <p>MATERIALS: Oak, Leather DIMENSIONS: Diameter 14 cm, height 30,5 cm COLLI: 2 ITEM NO.: S1930239</p>		 5 706420 073819



HAMMER GRINDER CHRISTOFFER HARLANG

DESCRIPTION	EXCL. VAT	INCL. VAT
	65	79
 <p>MATERIALS: Oak DIMENSIONS: Diameter 6,5 cm, height 12 cm COLLI: 2 ITEM NO.: 1836571</p>		 5 706420 103097



HAMMER GRINDER CHRISTOFFER HARLANG

DESCRIPTION	EXCL. VAT	INCL. VAT
	65	79
 <p>MATERIALS: Teak COLOUR: Oiled DIMENSIONS: Diameter 6,5 cm, height 12 cm COLLI: 2 ITEM NO.: 1836572</p>		 5 706420 103080



AINO MIRROR SMALL WESLEY WALTERS & SALLA LUHTASELA

DESCRIPTION	EXCL. VAT	INCL. VAT
	131	159
 <p>MATERIALS: Oak, Mirror DIMENSIONS: Width 14 cm, depth 4 cm, height 21 cm COLLI: 1 ITEM NO.: 1480003</p>		 5 706420 094227



AINO MIRROR LARGE WESLEY WALTERS & SALLA LUHTASELA

DESCRIPTION	EXCL. VAT	INCL. VAT
	205	249
 <p>MATERIALS: Oak, Mirror DIMENSIONS: Width 26,5 cm, depth 7 cm, height 32 cm COLLI: 1 ITEM NO.: 1480004</p>		 5 706420 094241



DANIA MAT SKAGERAK

DESCRIPTION	EXCL. VAT	INCL. VAT
	189	229
 <p>MATERIALS: Teak, Stainless Steel DIMENSIONS: Length 58,5 cm, width 41 cm, height 2,5 cm COLL: 1 ITEM NO.: S1600231</p>		 5 706420 028840



DANIA STOOL DESIGNIT

DESCRIPTION	EXCL. VAT	INCL. VAT
	189	229
 <p>MATERIALS: Teak DIMENSIONS: Width 38 cm, depth 34,5 cm, height 27,5 cm COLL: 1 ITEM NO.: S1600630</p>		 5 706420 036845

DANIA STOOL DESIGNIT



DESCRIPTION	EXCL. VAT	INCL. VAT
	189	229
 <p>MATERIALS: Oak DIMENSIONS: Width 38 cm, depth 34,5 cm, height 27,5 cm COLL: 1 ITEM NO.: S1600631</p>		 5 706420 054214

DANIA BOX 2 SKAGERAK

DESCRIPTION	EXCL. VAT	INCL. VAT
	81	99
 <p>MATERIALS: Teak DIMENSIONS: Length 31 cm, width 22 cm, height 13 cm COLL: 1 ITEM NO.: S1600572</p>		 5 706420 049388



DANIA BOX 3 SKAGERAK

DESCRIPTION	EXCL. VAT	INCL. VAT
	114	139

	MATERIALS: Teak DIMENSIONS: Length 31 cm, width 22 cm, height 25,5 cm COLLI: 1 ITEM NO.: S1600568	 5 706420 034292
--	--	--



DANIA BOX 4 SKAGERAK

DESCRIPTION	EXCL. VAT	INCL. VAT
	114	139

	MATERIALS: Teak DIMENSIONS: Length 44,5 cm, width 31 cm, height 13 cm COLLI: 1 ITEM NO.: S1600571	 5 706420 047117
--	--	--



DANIA LETTER TRAY SKAGERAK

DESCRIPTION	EXCL. VAT	INCL. VAT
	164	199



	MATERIALS: Oak DIMENSIONS: Length 28 cm, width 40 cm, height 21 cm COLLI: 1 ITEM NO.: S1902007	 5 706420 070740
--	---	--

NOMAD PEN HOLDER VE2



DESCRIPTION	EXCL. VAT	INCL. VAT
	36	44

	MATERIALS: Oak DIMENSIONS: Length 7,5 cm, width 7,5 cm, height 13 cm COLLI: 1 ITEM NO.: S1930242	 5 706420 074083
--	---	--

NOMAD LETTER TRAY VE2

DESCRIPTION	EXCL. VAT	INCL. VAT
	77	94
 <p>MATERIALS: Oak DIMENSIONS: Length 23,5 cm, width 32 cm, height 4 cm COLLI: 1 ITEM NO.: S1930240</p>		 5 706420 074045

NOMAD BOX VE2

DESCRIPTION	EXCL. VAT	INCL. VAT
	65	79
 <p>MATERIALS: Oak DIMENSIONS: Length 14 cm, width 14 cm, height 5,5 cm COLLI: 1 ITEM NO.: S1930231</p>		 5 706420 070931

EDGE POT STILLEBEN

DESCRIPTION	EXCL. VAT	INCL. VAT
	48	59
 <p>MATERIALS: Terracotta COLOUR: Burned Red DIMENSIONS: Diameter 18 cm, height 18 cm COLLI: 2 ITEM NO.: 1810410</p>		 5 706420 077756



EDGE POT STILLEBEN

DESCRIPTION	EXCL. VAT	INCL. VAT
	48	59
 <p>MATERIALS: Terracotta COLOUR: Light Grey DIMENSIONS: Diameter 18 cm, height 18 cm COLLI: 2 ITEM NO.: 1810433</p>		 5 706420 108986



EDGE POT STILLEBEN

DESCRIPTION	EXCL. VAT	INCL. VAT
	81	99
 <p>MATERIALS: Terracotta COLOUR: Burned Red DIMENSIONS: Diameter 25 cm, height 24 cm COLLI: 2 ITEM NO.: 1810430</p>		 5 706420 108955



EDGE POT STILLEBEN

DESCRIPTION	EXCL. VAT	INCL. VAT
	81	99
 <p>MATERIALS: Terracotta COLOUR: Light Grey DIMENSIONS: Diameter 25 cm, height 24 cm COLLI: 2 ITEM NO.: 1810434</p>		 5 706420 108993



EDGE POT STILLEBEN

DESCRIPTION	EXCL. VAT	INCL. VAT
	139	169
 <p>MATERIALS: Terracotta COLOUR: Burned Red DIMENSIONS: Diameter 35 cm, height 34 cm COLLI: 2 ITEM NO.: 1810431</p>		 5 706420 108962



EDGE POT STILLEBEN

DESCRIPTION	EXCL. VAT	INCL. VAT
	139	169
 <p>MATERIALS: Terracotta COLOUR: Light Grey DIMENSIONS: Diameter 35 cm, height 34 cm COLLI: 2 ITEM NO.: 1810435</p>		 5 706420 109006



STELLA CHRISTMAS TREE BASE SKAGERAK

DESCRIPTION	EXCL. VAT	INCL. VAT
	321	389
 <p> MATERIALS: Oak, Brass Plated Steel DIMENSIONS: Diameter 50,5 cm, height 15,5 cm COLLI: 1 ITEM NO.: 1986045 NOTE: Cup max diameter 9,5 cm </p>		 5 706420 101222

BEACH TENNIS (SKAGERAK GAMES) AURÉLIEN BARBRY

DESCRIPTION	EXCL. VAT	INCL. VAT
	139	169
 <p> MATERIALS: Teak, Canvas COLOUR: Dark Green, Dusty Coral DIMENSIONS: Length 36 cm, width 24 cm, height 3 cm COLLI: 1 ITEM NO.: 1994002 </p>		 5 706420 094043

BEACH TENNIS BALLS (SKAGERAK GAMES) AURÉLIEN BARBRY

DESCRIPTION	EXCL. VAT	INCL. VAT
	11	14
 <p> MATERIALS: Rubber COLOUR: Dusty Coral DIMENSIONS: Diameter 5,5 cm COLLI: 1 ITEM NO.: 1994002-6 </p>		 5 706420 098928

PRICE LIST 2024
SKAGERAK COLLECTION - INDOOR

EURO / VAT 21% / 11.2023

FRITZ HANSEN

CONTENT

03 • GENERAL TERMS AND CONDITIONS

CHAIRS AND BENCHES

- 05 • Cutter
- 06 • Dania
- 07 • Director's Chair
- 08 • Fionia
- 09 • Georg
- 10 • Hven
- 11 • Maissi
- 12 • Noboru
- 13 • Nomad
- 14 • Vent
- 15 • Vester

TABLES

- 16 • Aldus
- 17 • Georg
- 18 • Georg
- 19 • Hven
- 20 • Hven

STORAGE AND SHELVING

- 21 • Cutter
- 22 • Georg
- 23 • Jut
- 24 • Norr
- 25 • Vivlio

MIRRORS

- 26 • Cutter
- 27 • Georg

OTHER

- 28 • Dryp
- 29 • Georg

SPARE PARTS

- 30 • Cura Soap & Oils

SURFACE SELECTION

- 31 • Surface Selection

GENERAL TERMS AND CONDITIONS

CURRENCY & EFFECTIVE DATE

This price list is valid from 1 November 2023 and cancels all prior price lists.

Reservation is made for any errors and omissions. Furthermore, below general terms and conditions shall apply to all contracts under which Fritz Hansen A/S (Fritz Hansen) is the supplier/sub-supplier.

ORDERING

Orders must be placed through Fritz Hansen's web-based order system called the Partner Portal (www.fritzhansen.com - professional). Orders are not binding until the customer has received a written order confirmation from Fritz Hansen.

Price lists state the recommended retail price (RRP) or prices excl. VAT exclusive of freight and fees. All prices can be changed without notice. Changes to the collection such as discontinued products and/or items out of stock can occur even when stated differently in the price list. Updated information will be available on the partner portal only.

ORDER CANCELLATION

Orders can be cancelled in accordance with the below rules:

	ORDERS CANCELLED 0-3 DAYS AFTER ORDER CONFIRMATION HAS BEEN SENT	ORDERS CANCELLED 3-14 DAYS AFTER ORDER CONFIRMATION HAS BEEN SENT
STANDARD PRODUCTS	FEE: NONE	FEE: 5% OF NET PRICE EXCL. VAT.
SPECIALS OR MODIFIED PRODUCTS	FEE: FULL PRICE	

Change and cancellation of order after 14 days from receipt of the order confirmation is not possible.

DELIVERY

The following freight rates apply:

RATE	PER ORDER
EU+UK+NO+CH+US*	DKK 200 / € 55 / £ 50 / SEK 600 / NOK 550 / USD 55 EXCL. VAT.
REST OF THE WORLD	TO BE PICKED UP AT FRITZ HANSEN WAREHOUSES

For markets EU+UK+NO+CH+US free freight offered according to the following rates: Free shipping from DKK 3.000 / € 400 / £ 350 / SEK 4.500 / NOK 4.000 / USD 500 total order value excl. VAT.

* For deliveries to outer areas such as islands in Portugal and Spain as well as Svalbard in Norway and others, a surcharge of DKK 420 / € 56 / £ 42 / NOK 580 per parcel will apply.

Standard delivery terms:

- Denmark: DDP delivery address (INCO-Terms 2020)
- Countries within the EU: DDP delivery address (INCO-Terms 2020)
- European countries outside the EU: DAP delivery address (INCO-Terms 2020)
- USA & Canada: DDP delivery address (INCO-Terms 2020)
- Japan: DDP delivery address (INCO-Terms 2020)
- South Korea: DAT Seoul Airport (INCO-Terms 2020)
- Middle East, Asia, South and Central America, Australia: FCA Fritz Hansen warehouses in Denmark and Poland (INCO-Terms 2020)

For FCA: The goods must be picked up at the Fritz Hansen warehouses no later than 30 calendar days after the confirmed shipping date of the consolidated order. Address(es) for pickup will be specified on the commercial invoice. If the goods are not picked up, Fritz Hansen will charge the customer DKK 24 / € 3 / USD 4 per day per pallet.

If the partner so desires, Fritz Hansen can deliver at the end user's address against an additional fee.

CLAIMS

The physical product must be inspected upon delivery. Damage incurred in transit as well as any defects and deficiencies on the product incurred as a result of transportation must be recorded on the POD upon delivery. Fritz Hansen must be notified in writing of any claims about product defects and deficiencies within 48 hours of delivery. If the claims are made in due time and with the acceptance of Fritz Hansen, the customer is entitled to demand a replacement delivery or to have the defect remedied. The customer cannot demand a reduction or a compensation. Claims/replacements can only be made to the customer's address if delivery has not been made directly to the end user.

TERMS OF PAYMENT

Terms of payment are 30 days net cash from invoice date. Invoices are issued and dated when the goods are dispatched. In case of late payment, interest will be charged at a rate of 1.5 % for every month or part thereof as from the due date. Interest invoices are payable net cash within eight days. Fritz Hansen can decide that the customer shall pay in advance, if the customer's balance is or has previously been due, or if the order amount exceeds the credit limit approved by Fritz Hansen.

OBSERVATION OF TITLE

Title to the goods shall not pass to the customer until Fritz Hansen (or any third party to whom Fritz Hansen has assigned its rights to the purchase price) has received the full purchase price and been reimbursed any expenses incurred.

WARRANTY

Fritz Hansen provides a standard five-year warranty on standard products within the collections Furniture and Skagerak Collection (Indoor & Outdoor) against defects in materials and workmanship. For the Arne Jacobsen shell chairs (Ant™, Grand Prix™, Lily™, Series 7™), the standard warranty is 10 years. Within the Furniture collection, an extended warranty of up to 10 years is provided on selected products, provided they have been registered online on www.fritzhansen.com/my-fh (see table on the next page for details).

For the Poul Kjærholm collection, the standard warranty is 20 years except for PK0 A™ and PK60™, which is 10 years, and the PK15™, which is 5 years. Wicker and French Cane have a warranty of 2 years.

For the Lighting, Accessories and Skagerak Collection Accessories the standard warranty is 2 years. Specific for the Lighting category: Transformers, ballasts, light sources, and other electronic devices are subject to the warranty terms of the manufacturer in question. Fritz Hansen does not cover costs related to installation and dismantling, replacement of ballasts/transformers and other similar costs related to electricians and the like.

The warranty on all collections does not extend to ordinary tear, wear or damage to upholstery. On any material, textile, or leather which is not listed in our price lists configured on a specific product, the standard warranty is 2 years. The warranty is void upon subsequent changes to the product.

Additional warranty conditions can be found on www.fritzhansen.com.

LIMITATION OF LIABILITY

Fritz Hansen will assume no liability for any loss as a result of delays, defects or any other breach of contract, unless such loss was caused by gross negligence on the part of Fritz Hansen. Fritz Hansen will assume no liability for any indirect loss, including loss of profits, operating loss, goodwill, loss of customers, running costs or any other consequential economic loss.

CHOICE OF LAW AND JURISDICTION

Disputes between Fritz Hansen and its customers shall be subject to Danish law, except for the international civil law rules of Danish law, and shall be settled by Fritz Hansen's home court.

MEASUREMENTS

The stated measurements act only as a guideline. The measurements can vary, and size difference on a product can occur.

FORCE MAJURE

Fritz Hansen is without liability for non-performance of Fritz Hansen's obligations in respect to any orders received, if such non-performance is due to circumstances out of Fritz Hansen's reasonable control, which prevent the fulfilment of the purchase agreement or makes the fulfilment unreasonably burdensome. As examples of such circumstances the following can be mentioned: Industrial dispute and other circumstances which are beyond the control of the parties, such as fire, war, mobilization or calling in for military service of similar extent, requisition, seizure, exchange controls, riots or disturbances, shortage of means of transportation, ordinary scarcity of goods, restrictions of motive power and defects in or late performance from sub-suppliers due to any of the aforementioned circumstances.

The above circumstances only lead to exemption from liability if their influence on the fulfilment of the purchase agreement could not be anticipated at the conclusion of the agreement. Fritz Hansen must without undue delay notify the customer in writing if any such circumstances, occurrence and cessation, if Fritz Hansen wishes to invoke any grounds of exemption from liability.

Regardless of what follows from these general conditions of sales and delivery, any party is entitled to terminate the purchase agreement by notifying the other party in writing, if the fulfilment of the agreement is prevented for more than 6 months due to one of the above circumstances.

Unless mandatory rules preclude this, Fritz Hansen is in no case liable to the customer for operating losses, lost earnings, or other financial consequential damages under these general conditions for sale and delivery.

PRIVACY POLICY

At Fritz Hansen, confidentiality and data protection is a high priority. Guidelines for processing of personal data and description of the customer's and end users' rights according to applicable data protection law is governed by Fritz Hansen's privacy policy available on Fritz Hansen's website.

WARRANTY OVERVIEW

Price list collections	Furniture Collection						Poul Kjærholm Collection				Skagerak Collection		Lighting Collection	Accessories Collection					
	Textile, Cushions	Leather (1)	Leather (2)	Bases (3)	Bases (4)	Movable parts (5)	Anrt™ Grand Prix™, Lily™, Series 7™	Shells, Tabletops	Tabletops (6)	China Chair™	French Cane, Wicker	PK15™	PKO A™ & PK60™	Poul Kjærholm Collection	Outdoor	Indoor	Lighting	Accessories	Skagerak Collection
2 years										x							x	x	x
5 years	x	x		x		x		x			x			x	x				
10 years			x*		x*		x	x*				x**							
20 years									x**				x**						

1. Leather: Soft and Essential
2. Leather: Aura, Rustik, Natural, Grace and Embrace
3. Bases: Lacquered and Wooden (chairs), Powder coated (chairs and tables)
4. Bases: Aluminium, Chrome and Wooden (tables)
5. Moveable parts: Automatic return, Tilt, Height-adjustable, Swivel, Castors and Extension mechanism
6. Tabletops: Lacquer under tabletop, Lacquer on edges and Surface on tabletop

* Additional with registration on www.fritzhansen.com/my-fh

** Standard without registration



Dania Step Ladder is designed from a simple and functional approach to a practical object. Perfect for reaching high places or as an easy step up for the little ones. The bottom step slides in and out as needed, making it easy to use as a stool as well.

ITEM NO.	DESCRIPTION	EXCL. VAT	INCL. VAT
S1600517	Dania step ladder, teak FSC 100%, bottom step slides in and out	362	439
S1600536	Dania step ladder, oak FSC mix, bottom step slides in and out	362	439

STEP LADDER

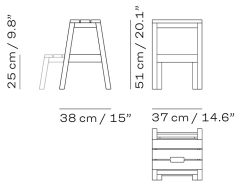



DIRECTOR'S CHAIR
SKAGERAK DESIGN

11.2023

Director's Chair is foldable, comfortable and beautiful to behold.

ITEM NO.	DESCRIPTION	EXCL. VAT	INCL. VAT
S1900585	Director's chair, seat height 46 cm, teak FSC 100%/canvas	577	699

CHAIR

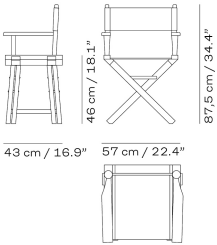



The Fionia Stool is available in both Oak and Teak versions.

ITEM NO.	DESCRIPTION	EXCL. VAT	INCL. VAT
S1600503	Fionia stool, seat height 44 cm, oak FSC 100%	271	329
S1600505	Fionia stool, seat height 44 cm, teak FSC 100%	271	329

STOOL

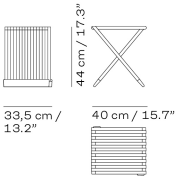



Hven is a collection of inviting and minimalist furniture with a natural Nordic look and feel. Hven is named after the Swedish island that lies in the strait between Denmark and Sweden. Designed in collaboration with contemporary Swedish designer, Anton Björnsing, the minimalistic collection is easy to mix with other furniture.

CHAIRS

ITEM NO.	DESCRIPTION	EXCL. VAT	INCL. VAT
1420010	Hven armchair, seat height 44,5 cm, oak FSC 100%	610	739
1420010-1	Hven armchair, seat height 44,5 cm, oak/white soap FSC 100%	701	849
1420010-2	Hven armchair, seat height 44,5 cm, oak/white oil FSC 100%	701	849
1420010-3	Hven armchair, seat height 44,5 cm, oak oil FSC 100%	701	849

CUSHIONS CHAIRS

ITEM NO.	DESCRIPTION	EXCL. VAT	INCL. VAT
1950530	Hven chair cushion, cognac, dunes aniline leather	189	229

BAR STOOLS

ITEM NO.	DESCRIPTION	EXCL. VAT	INCL. VAT
1420026	Hven bar stool, seat height 46 cm, oak FSC 100%	610	739
1420026-1	Hven bar stool, seat height 46 cm, oak/white soap FSC 100%	742	899
1420026-2	Hven bar stool, seat height 46 cm, oak/white oil FSC 100%	742	899
1420026-3	Hven bar stool, seat height 46 cm, oil oak FSC 100%	742	899

CUSHIONS BAR STOOLS

ITEM NO.	DESCRIPTION	EXCL. VAT	INCL. VAT
1961038	Hven bar stool cushion, dunes aniline leather, cognac	180	219

BENCHES

ITEM NO.	DESCRIPTION	EXCL. VAT	INCL. VAT
1420021	Hven bench, seat height 17.7 in, oak FSC 100%	742	899
1420021-1	Hven bench, seat height 17.7 in, oak/white soap FSC 100%	866	1.049
1420021-2	Hven bench, seat height 17.7 in, oak/white oil FSC 100%	866	1.049
1420021-3	Hven bench, seat height 17.7 in, oil oak FSC 100%	866	1.049

CUSHIONS BENCHES

ITEM NO.	DESCRIPTION	EXCL. VAT	INCL. VAT
1950532	Hven bench cushion, cognac, dunes aniline leather	296	359

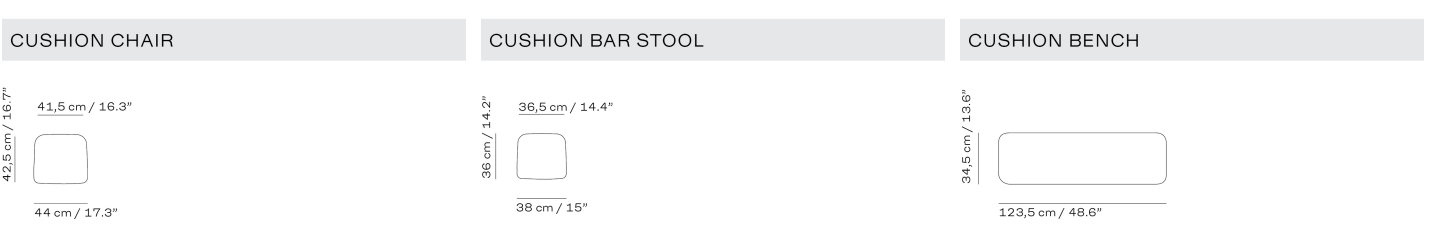
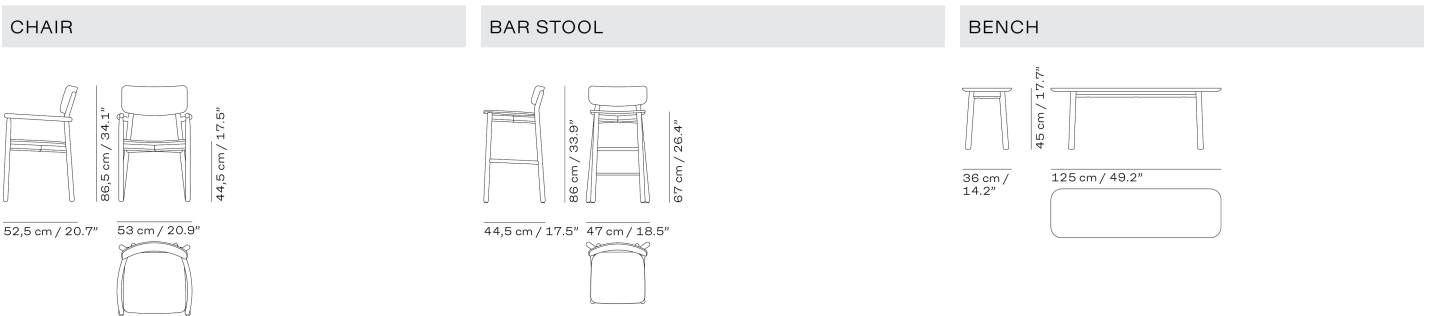



MAISSI
WESLEY WALTERS & SALLA LUHTASELA

11.2023

Maissi is an artistic two-person bench with a unique look in FSC-certified oak. The narrow style and clean cuts make it a welcoming piece in any modern space, from the hallway to the bedroom or living room.

ITEM NO.	DESCRIPTION	EXCL. VAT	INCL. VAT
1480080	Maissi bench, seat height 17.7 in, oak FSC 100%	1.032	1.249
1480080-1	Maissi bench, seat height 17.7 in, oak/white soap FSC 100%	1.156	1.399
1480080-2	Maissi bench, seat height 17.7 in, oak/white oil FSC 100%	1.156	1.399
1480080-3	Maissi bench, seat height 17.7 in, oil oak FSC 100%	1.156	1.399

BENCH

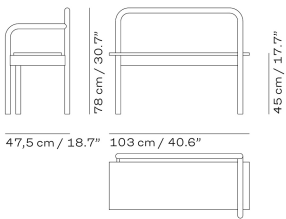



Taking its name from the Japanese word 'to climb,' the minimalist and multifunctional Noboru Step Ladder works wonderfully as a seat, ladder or a side table. Crafted in solid FSC™-certified oak, it channels the perfect balance of Japanese and Scandinavian sensibilities. Designed by the Canadian Design Studio MSDS.

ITEM NO.	DESCRIPTION	EXCL. VAT	INCL. VAT
1420060	Noboru step ladder, seat height 47 cm, oak FSC 100%, lower step slides in	371	449

STEP LADDER

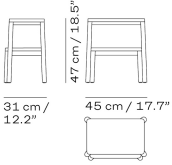



NOMAD VE2

11.2023

Crafted from untreated FSC-certified oak, Nomad is a minimalist iteration of the traditional three-legged stool. The elegant and stackable design is rooted in a passion for high-quality materials, form and function and perfectly encapsulates the adage 'less is more.'

ITEM NO.	DESCRIPTION	EXCL. VAT	INCL. VAT
1930252	Nomad stool, seat height 17.7 in, oak FSC 100%, stackable (max 4 pcs)	214	259

STOOL

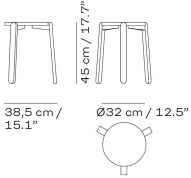

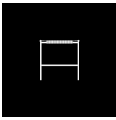

VENT

CHRIS LILJENBERG HALSTRØM

11.2023

The Vent series is named after the Danish word for wait—a nod to its origins as seating conceived for leisurely viewing artworks at museums. Handmade in collaboration with a local workshop for the blind and sight impaired, the designs marry form with function. Designed by the Danish/Swedish furniture designer Chris Liljenberg Halstrøm

STOOLS

ITEM NO.	DESCRIPTION	EXCL. VAT	INCL. VAT
1930650	Vent stool, seat height 17.7 in, black steel, Neutral Paper Cord	536	649

BENCHES

ITEM NO.	DESCRIPTION	EXCL. VAT	INCL. VAT
1930651	Vent bench, seat height 17.7 in, black steel, Neutral Paper Cord	949	1.149

STOOL

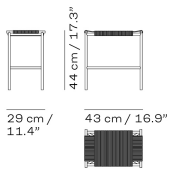

BENCH

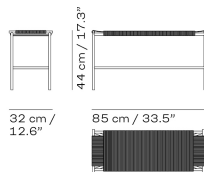



VESTER
CHRIS LILJENBERG HALSTRØM

11.2023

A dining chair designed in a well-proportioned idiom, the Vester Chair combines beauty and elegance with function and comfort. A transverse brass rod at the back indicates where to pull out the chair. Legs continuing up into the backrest form a small hook for hanging a purse or small item. The chair's body in golden oiled 100% FSC-certified oak naturally contrasts the fine brass detailing in this award-winning piece.

CHAIRS

ITEM NO.	DESCRIPTION	EXCL. VAT	INCL. VAT
1092000-3	Vester chair, seat height 44,5 cm, oil oak/brass, FSC 100%	726	879

CUSHIONS CHAIRS

ITEM NO.	DESCRIPTION	EXCL. VAT	INCL. VAT
1961070	Vester chair cushion, dunes leather, cognac	189	229

CHAIR

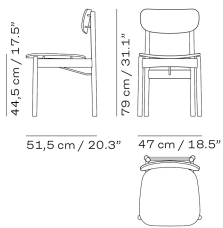

CUSHION CHAIR

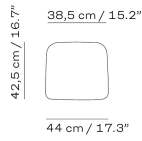



The Aldus series looks to the trestle table for its design cues. Bearing all the hallmarks of great craftsmanship, pieces fuse traditional techniques and high-quality materials with modern elegance. Designed by the Danish/Swedish furniture designer Chris Liljenberg Halstrøm.

ITEM NO.	DESCRIPTION	EXCL. VAT	INCL. VAT
1420036	Aldus table 160, table height 73 cm, oil oak/oak veneer FSC mix	2.065	2.499
1420037	Aldus table 180, table height 73 cm, oil oak/oak veneer FSC mix	2.230	2.699
1420034	Aldus table 200, table height 73 cm, oak oil FSC mix	2.313	2.799

TABLE 160

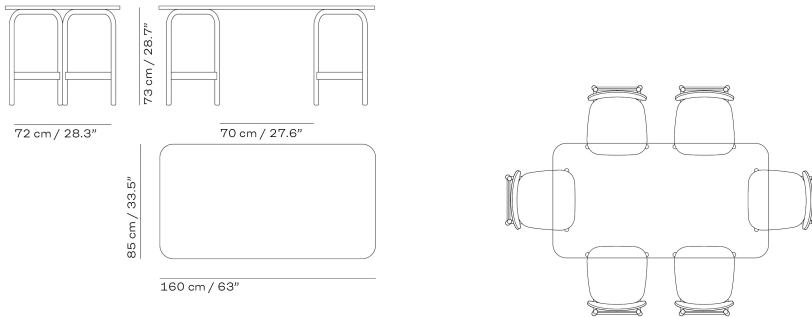

TABLE 180

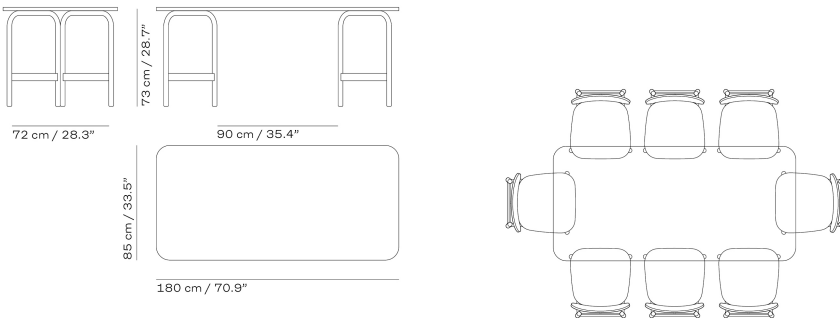
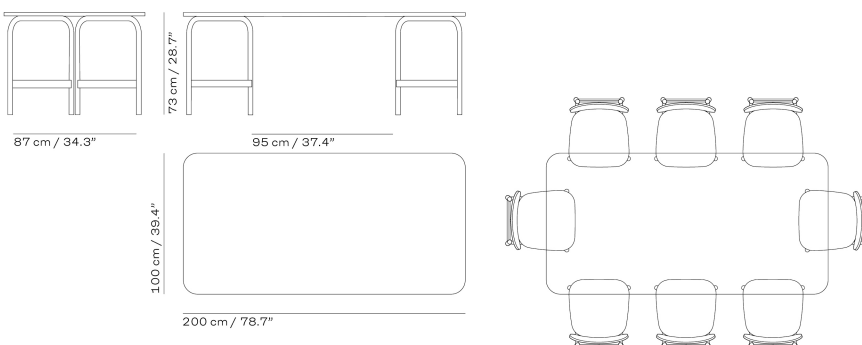

TABLE 200





Georg is a collection of functional furniture and accessories made from a warm mix of Nordic sensuality and Japanese minimalism. Designed in collaboration with Nordic designer, Chris Liljenberg Halstrøm.

CONSOLE TABLES

ITEM NO.	DESCRIPTION	EXCL. VAT	INCL. VAT
S1930302	Georg console table, table height 73 cm, oak FSC 100%	726	879
S1930310	Georg console table, table height 73 cm, black oak FSC 100%	759	919

DESKS

ITEM NO.	DESCRIPTION	EXCL. VAT	INCL. VAT
S1930331	Georg desk wall, table height 73 cm, oak FSC 100 %	866	1.049
1930349-1	Georg desk, table height 73 cm, oak/white soap FSC 100%	1.238	1.499
1930349-2	Georg desk, table height 73 cm, oak/white oil FSC 100%	1.238	1.499
1930349-3	Georg desk, table height 73 cm, oak/oil FSC 100%	1.238	1.499
1930366	Georg desk drawer, silk grey brackets, oak FSC 100%	156	189
1930366-1	Georg desk drawer, silk grey bracket,oak/white soap FSC 100%	263	319
1930366-2	Georg desk drawer, silk grey bracket, oak/white oil FSC 100%	263	319
1930366-3	Georg desk drawer, silk grey brackets, oak oil FSC 100%	263	319

SIDE TABLES

ITEM NO.	DESCRIPTION	EXCL. VAT	INCL. VAT
1930347	Georg side table, table height 44 cm, oak FSC 100%	214	259

TABLES

ITEM NO.	DESCRIPTION	EXCL. VAT	INCL. VAT
1930505	Georg dining table, table height 73 cm, oak white soap FSC mix	1.817	2.199
1930506	Georg dining table, table height 73 cm, oak/ white oil FSC mix	1.817	2.199
1930507	Georg dining table, table height 73 cm, oak oil FSC mix	1.817	2.199
1930508	Georg dining table, table height 73 cm, oak FSC mix	1.528	1.849



CONSOLE TABLE

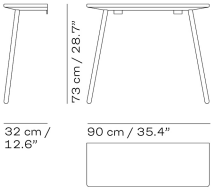

DESK WALL

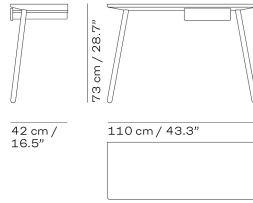

DESK

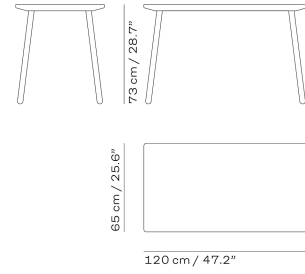

DRAWER

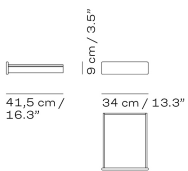

SIDE TABLE

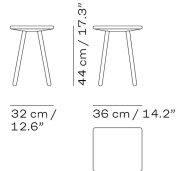

DINING TABLE

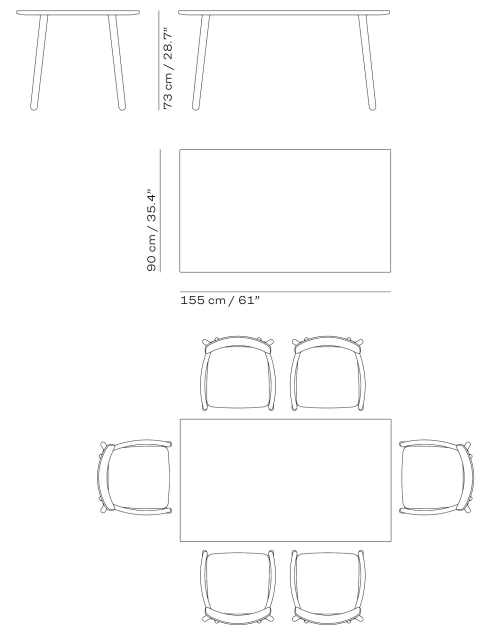



Hven Table is made from solid, FSC-certified oak with a stunning grain pattern and remarkable durability. A soft, minimalist design characterised by round legs and corners.

ITEM NO.	DESCRIPTION	EXCL. VAT	INCL. VAT
1420009	Hven table Ø110, table height 73 cm, oak FSC 100%	2.065	2.499
1420009-1	Hven table Ø110, table height 73 cm, oak/white soap FSC 100%	2.313	2.799
1420009-2	Hven table Ø110, table height 73 cm, oak/white oil FSC 100%	2.313	2.799
1420009-3	Hven table Ø110, table height 73 cm, oak oil FSC 100%	2.313	2.799
1420005	Hven table 190, table height 73 cm, oak FSC 100%	2.974	3.599
1420005-1	Hven table 190, table height 73 cm, oak/white soap FSC 100%	3.222	3.899
1420005-2	Hven table 190, table height 73 cm, oak/white oil FSC 100%	3.222	3.899
1420005-3	Hven table 190, table height 73 cm, oak oil FSC 100%	3.222	3.899
1420008	Hven table 260, table height 73 cm, oak FSC 100%	3.718	4.499
1420008-1	Hven table 260, table height 73 cm, oak/white soap FSC 100%	3.966	4.799
1420008-2	Hven table 260, table height 73 cm, oak/white oil FSC 100%	3.966	4.799
1420008-3	Hven table 260, table height 73 cm, oak oil FSC 100%	3.966	4.799

EXTENSION LEAF

ITEM NO.	DESCRIPTION	EXCL. VAT	INCL. VAT
1420007	Hven table Extension Plate, light grey MDF, TSCA, fits	453	549

TABLE Ø110

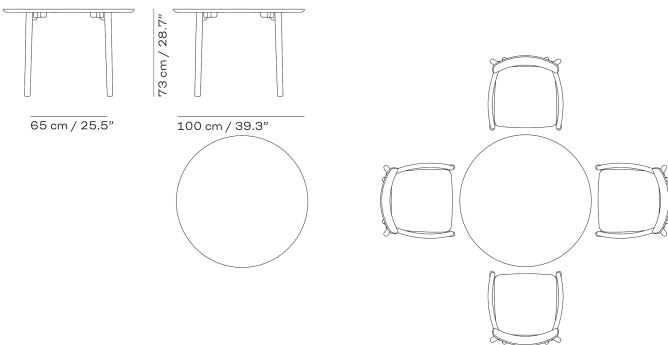



TABLE 190

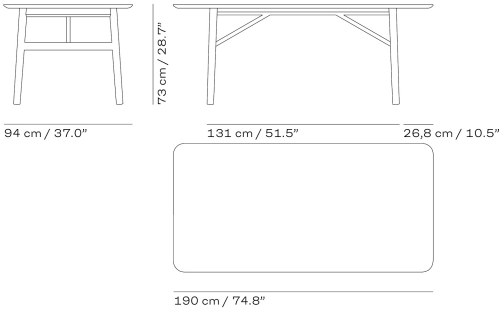
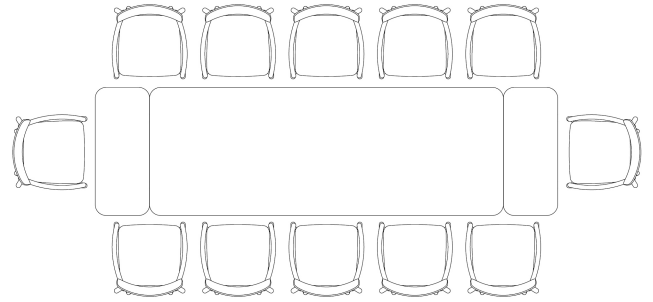
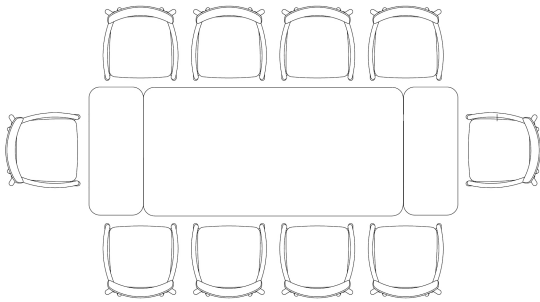
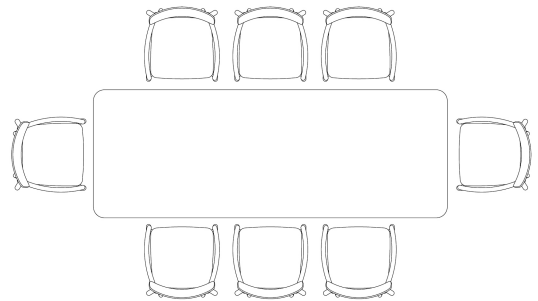
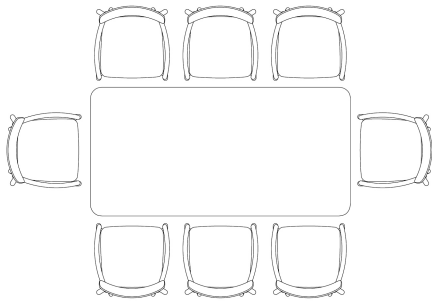
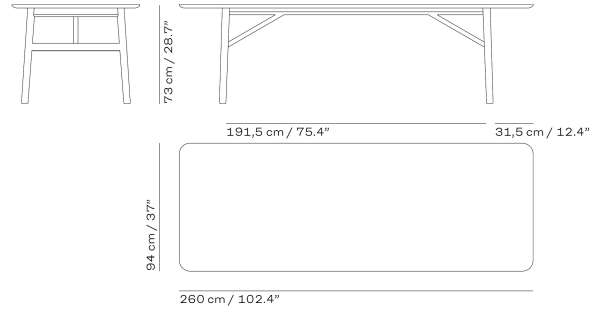
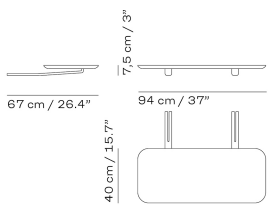
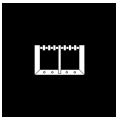

TABLE 260



EXTENSION LEAF





The iconic Cutter series designed in collaboration with Danish designer, Niels Hvass, is minimalistic, functional and a popular choice for hallways. Inspired by the German Bauhaus movement, the series contains many options and combinations giving a wonderful array of choice to suit every home.

BOXES

ITEM NO.	DESCRIPTION	EXCL. VAT	INCL. VAT
S1920430	Cutter box small, teak	106	129
S1920433	Cutter box small, black oak FSC mix	114	139
S1920435	Cutter box small, oak FSC mix	106	129
S1920420	Cutter box large, teak	189	229
S1920423	Cutter box large, black oak FSC mix	205	249
S1920425	Cutter box large, oak FSC mix	189	229

MINI WARDROBE

ITEM NO.	DESCRIPTION	EXCL. VAT	INCL. VAT
S1920451	Cutter mini wardrobe, oak FSC mix/stainless steel	288	349
S1920452	Cutter mini wardrobe, teak FSC 100%/stainless steel	288	349
S1920454	Cutter mini wardrobe, black oak FSC mix/stainless steel	296	359

WARDROBE

ITEM NO.	DESCRIPTION	EXCL. VAT	INCL. VAT
S1920455	Cutter wardrobe, oak FSC mix/stainless steel	635	769
S1920450	Cutter wardrobe, teak FSC 100%/stainless steel	635	769
S1920453	Cutter wardrobe, black oak FSC mix/stainless steel	676	819

COAT RACKS

ITEM NO.	DESCRIPTION	EXCL. VAT	INCL. VAT
S1920482	Cutter coat rack 72, oak FSC mix/stainless steel	189	229
S1920483	Cutter coat rack 72, teak FSC 100%/stainless steel	189	229
S1920484	Cutter coat rack 72, black oak FSC mix/stainless steel	205	249
S1920480	Cutter coat rack 100, oak FSC mix/stainless steel	271	329
S1920481	Cutter coat rack 100, teak/stainless steel	271	329
S1920489	Cutter coat rack 100, black oak FSC mix/stainless steel	296	359

BOX SMALL

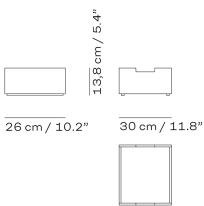

BOX LARGE

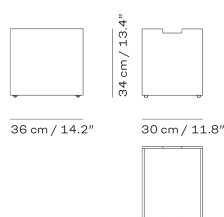

MINI WARDROBE

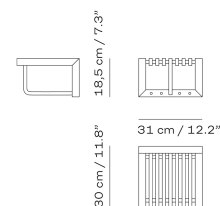

WARDROBE

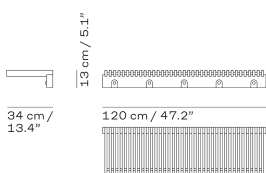

COAT RACK 72

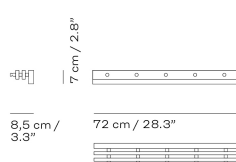

COAT RACK 100

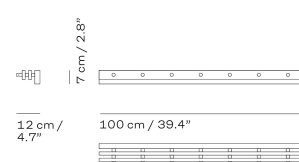



Two short, one long. Georg Rack gets its form from a simple construction of slender wooden poles. The Georg Rack is made of FSC-certified oak and works well with the Georg Hanger.

ITEM NO.	DESCRIPTION	EXCL. VAT	INCL. VAT
S1930313	Georg rack 60, oak FSC 100%	98	119
S1930312	Georg rack 60, black oak FSC 100%	106	129
S1930304	Georg rack 115, oak FSC 100%	131	159
S1930311	Georg rack 115, black oak FSC 100%	139	169
S1930318	Georg hanger, oak FSC 100%	28	34
S1930317	Georg hanger, black oak FSC 100%	32	39

RACK 60

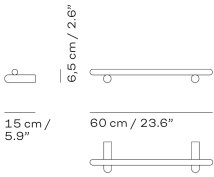

RACK 115

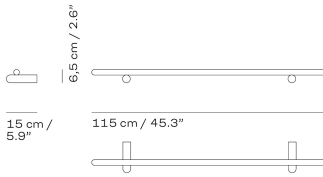

HANGER

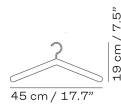

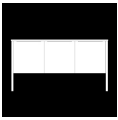

The round legs placed at the outer corners and the sleek brass handles give Jut a light and graceful expression. The shelves of the cabinet are adjustable with fittings on the inner side. Jut High Cabinet is suitable in almost any room, adding contemporary Nordic functionality to the practicality of storage. The tabletop comes in either oak or marble – both materials known for their beautifully vivid structures.

ITEM NO.	DESCRIPTION	EXCL. VAT	INCL. VAT
1090102	Jut cabinet, table height 68 cm, oak FSC mix	2.065	2.499
1090101	Jut cabinet, table height 68 cm, black marble/oak FSC mix	2.561	3.099
1090104	Jut cabinet, table height 68 cm, green marble/oak FSC mix	2.561	3.099
1090106	Jut high cabinet, table height 114 cm, black marble/ oak FSC mix	2.561	3.099
1090107	Jut high cabinet, table height 114 cm, green marble/ oak FSC mix	2.561	3.099
1090108	Jut high cabinet, table height 114 cm, oak FSC mix	2.065	2.499

CABINET

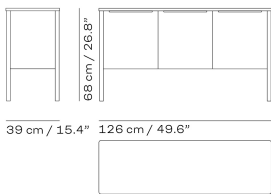

CABINET HIGH

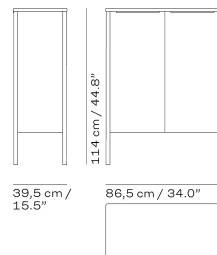

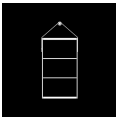

The Norr series in FSC-certified oak takes its cues from Scandinavian simplicity. Functional, well-crafted and beautiful designs for the home perfectly encapsulate the adage 'less is more'.

ITEM NO.	DESCRIPTION	EXCL. VAT	INCL. VAT
1930255	Norr shelf, oak FSC 100%/leather/brass	296	359
1930249	Norr magazine holder, oak FSC 100%	230	279
1930270	Norr magazine holder 120, oak FSC 100%	346	419

SHELF

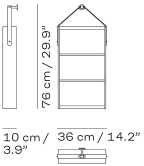

MAGAZINE HOLDER SMALL

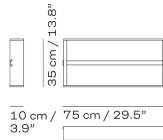

MAGAZINE HOLDER

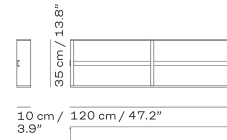



VIVLIO INCLUDED MIDDLE

11.2023

Vivlio is a modular shelving unit designed in collaboration with Chris L. Halstrøm and textile and colour designer Margrethe Odgaard of design studio, Included Middle. Space-optimising by design, the minimalist Vivlio shelving system allows for easy construction of a personalised unit, with the option to include multiple shelves and frames in different colours and sizes.

SHELVES

ITEM NO.	DESCRIPTION	EXCL. VAT	INCL. VAT
1930464	Vivlio shelf small, oak FSC mix	189	229
1930469	Vivlio shelf, small, black oak FSC mix	189	229
1930463	Vivlio shelf medium, oak FSC mix	214	259
1930468	Vivlio shelf, medium, black oak FSC mix	214	259
1930462	Vivlio shelf large, oak FSC mix	247	299
1930467	Vivlio shelf, large, black oak FSC mix	247	299

FRAMES

ITEM NO.	DESCRIPTION	EXCL. VAT	INCL. VAT
1930473	Vivlio frame, cinnamon brown	214	259
1930474	Vivlio frame, silk grey	214	259
1930475	Vivlio frame, black	214	259

SHELF SMALL

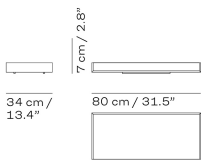

SHELF MEDIUM

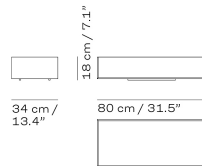

SHELF LARGE

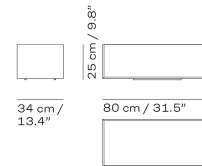

FRAME

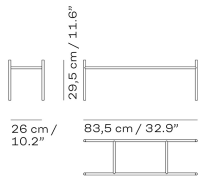



CUTTER NIELS HVASS

11.2023

A simple and contemporary mirror designed for the hallway or bedroom. A minimalist frame of four wooden mountings expresses the distinctive Cutter series design characteristics.

ITEM NO.	DESCRIPTION	EXCL. VAT	INCL. VAT
S1920440	Cutter mirror, Teak	511	619
S1920443	Cutter mirror, black oak FSC mix	536	649
S1920445	Cutter mirror, oak FSC mix	511	619

MIRROR

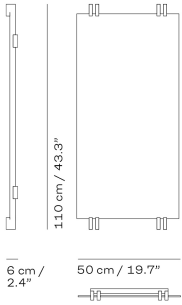



An elegant and practical wall-leaning mirror with Georg's characteristic slender wooden poles and rounded edges. The frame's two wooden poles can also be used for hanging bags, hats, scarves and more. The Georg Mirror is made of FSC-certified oak.

ITEM NO.	DESCRIPTION	EXCL. VAT	INCL. VAT
S1930303	Georg mirror, oak FSC 100%	453	549
S1930314	Georg mirror, black oak FSC 100%	470	569

MIRROR

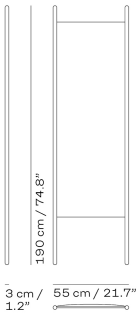



The practical and lightweight Dryp Drying Rack adds a pleasing aesthetic element to a practical household task.

ITEM NO.	DESCRIPTION	EXCL. VAT	INCL. VAT
S1600665	Dryp, oak FSC mix	321	389

DRYP

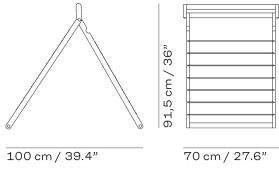

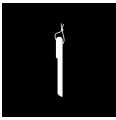

GEORG
CHRIS LILJENBERG HALSTRØM

11.2023

A flat, wooden hanger with elegant, rounded edges and a rotating hook. The Georg Hanger is made of FSC-certified oak.

ITEM NO.	DESCRIPTION	EXCL. VAT	INCL. VAT
1930338	Georg shoehorn, oak FSC 100%	77	94

SHOEHORN

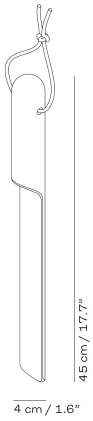



CURA SOAP & OILS
SKAGERAK DESIGN

11.2023

Cura is a series of oils and soap specially formulated to care for indoor and outdoor wooden furniture, ensuring it retains its colour and beauty with time and use.

ITEM NO.	DESCRIPTION	EXCL. VAT	INCL. VAT
1103041	Cura oil nature, wood care for indoor furniture	15	19
1103042	Cura oil white, wood care for indoor furniture	15	19
1103040	Cura soap, white, wood cleaner for indoor furniture	15	19

SURFACE SELECTION

SURFACE SELECTION

INVENTORY

- 33 • Upholstery
- 34 • Wood
- 35 • MDF
 - Marble
 - Steel
 - Paper cord

WE SUPPORT SUSTAINABLE WOOD SOURCING

One important step towards a more sustainable design industry is to support responsible wood sourcing and forest management. That is why we endorse the Forest Stewardship Council™ by increasing the total share of FSC™-certified wood in our production. Doing so, we help make sure that no more trees are felled than the forest can reproduce – and that local communities, biodiversity and forest workers are treated with respect. Since the FSC™ certification covers some areas of the world more thoroughly than others, we also take in PEFC-certified wood from Canada and the like.

Furthermore, we adhere to EU's Timber Regulation from 2013. This means that we perform due diligence on all shipments covered by the EUTR, to ensure that the wood comes from legal sources.

Look for our FSC-certified products.



**The mark of
responsible forestry**

SURFACE SELECTION

Colours and materials may vary from the images shown.
Actual colour, gloss level and structure may vary.

UPHOLSTERY

DIRECTOR'S CHAIR



WHITE
TEXTILE
CANVAS

GEORG



LIGHT GREY
TEXTILE
REMIX 3 - 123



DARK GREY
TEXTILE
REMIX 3 - 136



BEIGE
TEXTILE
LINEN



NATURAL*
LEATHER
NATURAL

*Only Georg Jubilee Stool

HVEN



COGNAC
LEATHER
DUNES

VESTER



COGNAC
LEATHER
DUNES

SURFACE SELECTION

Colours and materials may vary from the images shown.
Actual colour, gloss level and structure may vary.

UNTREATED VENEER



OAK
Vivio (Shelf)

COLOURED VENEER



OAK - BLACK
Vivio (Shelf)

UNTREATED SOLID WOOD



TEAK
Cutter
Dania
Director's Chair
Fionia

OAK
Cutter
Dania
Dryp
Fionia
Georg
Hven
Maissi
Noboru
Nomad
Norr

COLOURED SOLID WOOD

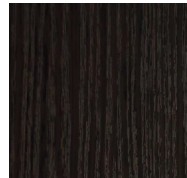

OAK - BLACK
Cutter
Georg (Bar stool)
Georg (Bench)
Georg (Console table)
Georg (Hanger)
Georg (Mirror)
Georg (Rack)
Georg (Stool)

OILED SOLID WOOD / VENEER



OAK - NATURAL
Aldus
Georg (Desk incl. drawer)
Georg (Dining table)
Hven
Jut
Maissi
Vester

OAK - WHITE PIGMENTED
Georg (Desk incl. drawer)
Georg (Dining table)
Hven
Maissi

SOAP TREATED SOLID WOOD / VENEER

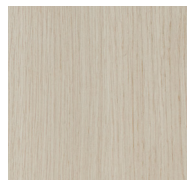

OAK - WHITE
Georg (Desk incl. drawer)
Georg (Dining table)
Hven
Maissi

SURFACE SELECTION

Colours and materials may vary from the images shown.
Actual colour, gloss level and structure may vary.

PAINTED MDF



LIGHT GREY

Hven (Extension plate)

HONED MARBLE

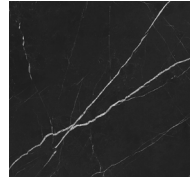

BLACK (NERO)

Jut



GREEN (VERDE)

Jut

POWDER COATED STEEL

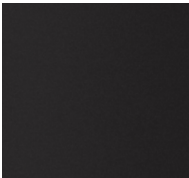

BLACK

Vent (Frame)

PAINTED STEEL

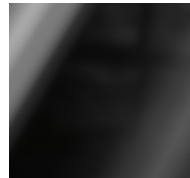

BLACK -
GLOSSY

Vivio (Frame)



CINNAMON BROWN -
GLOSSY

Vivio (Frame)



SILK GREY -
GLOSSY

Vivio (Frame)

PAPER CORD

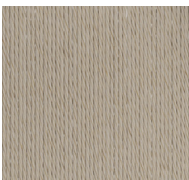

NATURAL

Vent (Seat)

