

Fritz Hansen Meubelen prijslijst

**PRICE LIST 2025**

FURNITURE EURO / EXCL. VAT 21% / 01.2025

Blz. 91 Outdoor collectie  
Blz 135 Poul-Kjærholm collectie  
Blz. 172 Lighting collectie  
Blz. 193 Accessoires

**FRITZ HANSEN**

# CONTENT

## 03 • GENERAL TERMS AND CONDITIONS

### CHAIRS

- 05 • Ant™
- 06 • Series 7™
- 07 • Series 7™
- 08 • Series 7™
- 09 • Children's Chairs / Junior
- 10 • Dot™ / High Dot™
- 11 • Grand Prix™
- 12 • Grand Prix™
- 13 • Grand Prix™
- 14 • Lily™
- 15 • Drop™
- 16 • Little Giraffe™
- 17 • Oxford™
- 18 • Oxford™
- 19 • N02™ Recycle
- 20 • Vico Duo™
- 21 • Vico Duo™
- 22 • China Chair™
- 23 • Carimate™
- 24 • Monolit™
- 25 • Taburet
- 26 • Utzon Stool

### LOUNGE

- 27 • Series 3300™
- 28 • Egg™
- 29 • Swan™
- 30 • Oksen™
- 31 • Pot™
- 32 • Lissoni Sofa™
- 33 • Ro™
- 34 • Fri™
- 35 • VIA57™
- 36 • Fred™
- 37 • Let™
- 38 • Monolit™

### SOFAS

- 39 • Series 3300™
- 40 • Swan Sofa™
- 41 • Lissoni Sofa™
- 42 • Lissoni Sofa™
- 43 • Alphabet™ Sofa Series
- 44 • Alphabet™ Sofa Series
- 45 • Favn™
- 46 • Lune™
- 47 • Lune™
- 48 • Ro™ Sofa
- 49 • Fri™ Sofa
- 50 • Plenum™
- 51 • Plenum™

### TABLES

- 52 • Superellipse™
- 53 • Superellipse™
- 54 • Supercircular™
- 55 • Circular
- 56 • Rectangular
- 57 • Egg™ Table
- 58 • FH3605™
- 59 • AJ Trolley™
- 60 • Essay™
- 61 • Essay™
- 62 • Analog™
- 63 • Pluralis™
- 64 • Pluralis™
- 65 • Pluralis™
- 66 • Pluralis™
- 67 • Little Friend™
- 68 • Planner™ Table Series

### SHELVING

- 69 • Planner™ Shelving

### OTHER

- 70 • Coat Tree™ / Coat Tree™ Wall

### SPARE PARTS

- 71 • Spare Parts
- 72 • Spare Parts

### SURFACE SELECTION

- 73 • Surface Selection

# GENERAL TERMS AND CONDITIONS

## CURRENCY & EFFECTIVE DATE

This price list is valid from 1 January 2025 and cancels all prior price lists.

Reservation is made for any errors and omissions. Furthermore, below general terms and conditions shall apply to all contracts under which Fritz Hansen A/S (Fritz Hansen) is the supplier/ sub-supplier.

## ORDERING

Orders must be placed through Fritz Hansen's web-based order system called the Partner Portal ([www.fritzhansen.com](http://www.fritzhansen.com) - professional). Orders are not binding until the customer has received a written order confirmation from Fritz Hansen.

Price lists state the recommended retail price (RRP) or prices excl. VAT exclusive of freight and fees. All prices can be changed without notice. Changes to the collection such as discontinued products and/or items out of stock can occur even when stated differently in the price list. Updated information will be available on the partner portal only.

## ORDER CANCELLATION

Orders can be cancelled in accordance with the below rules:

	ORDERS CANCELLED 0-3 DAYS AFTER ORDER CONFIRMATION HAS BEEN SENT	ORDERS CANCELLED 3-14 DAYS AFTER ORDER CONFIRMATION HAS BEEN SENT
STANDARD PRODUCTS	FEE: NONE	FEE: 5% OF NET PRICE EXCL. VAT.
SPECIALS OR MODIFIED PRODUCTS	FEE: FULL PRICE	

Change and cancellation of order after 14 days from receipt of the order confirmation is not possible.

## DELIVERY

The following freight rates apply:

RATE	PER ORDER
EU+UK+NO+CH+US*	DKK 200 / € 55 / £ 50 / SEK 600 / NOK 550 / USD 55 EXCL. VAT.
REST OF THE WORLD	TO BE PICKED UP AT FRITZ HANSEN WAREHOUSES

For markets EU+UK+NO+CH+US free freight offered according to the following rates: Free shipping from DKK 3.000 / € 400 / £ 350 / SEK 4.500 / NOK 4.000 / USD 500 total order value excl. VAT.

\* For deliveries to outer areas such as islands in Portugal and Spain as well as Svalbard in Norway and others, a surcharge of DKK 420 / € 56 / £ 42 / NOK 580 per parcel will apply.

### Standard delivery terms:

- Denmark: DDP delivery address (INCO-Terms 2020)
- Countries within the EU: DDP delivery address (INCO-Terms 2020)
- European countries outside the EU: DAP delivery address (INCO-Terms 2020)
- USA: DDP delivery address (INCO-Terms 2020)
- Canada DAP delivery address (INCO-Terms 2020)
- Japan: DDP delivery address (INCO-Terms 2020)
- South Korea: DDP Fritz Hansen Busan (INCO-Terms 2020)
- Middle East, Asia, South and Central America, Australia: FCA Fritz Hansen warehouses in Denmark (INCO-Terms 2020)

For FCA: The goods must be picked up at the Fritz Hansen warehouses no later than 30 calendar days after the confirmed shipping date of the consolidated order. Address(es) for pickup will be specified on the commercial invoice. If the goods are not picked up, Fritz Hansen will charge the customer DKK 24 / € 3 / USD 4 per day per colli (all furniture orders are colli based) or pallet (all Lighting, Accessories, and Skagerak Collection orders are pallet based).

If the partner so desires, Fritz Hansen can deliver at the end user's address against an additional fee.

## CLAIMS

The physical product must be inspected upon delivery. Damage incurred in transit as well as any defects and deficiencies on the product incurred as a result of transportation must be recorded on the POD upon delivery. Fritz Hansen must be notified in writing of any claims about product defects and deficiencies within 48 hours of delivery. If the claims are made in due time and with the acceptance of Fritz Hansen, the customer is entitled to demand a replacement delivery or to have the defect remedied. The customer cannot demand a reduction or a compensation. Claims/replacements can only be made to the customer's address if delivery has not been made directly to the end user.

## TERMS OF PAYMENT

Terms of payment are 30 days net cash from invoice date. Invoices are issued and dated when the goods are dispatched. In case of late payment, interest will be charged at a rate of 1.5 % for every month or part thereof as from the due date. Interest invoices are payable net cash within eight days. Fritz Hansen can decide that the customer shall pay in advance, if the customer's balance is or has previously been due, or if the order amount exceeds the credit limit approved by Fritz Hansen.

## OBSERVATION OF TITLE

Title to the goods shall not pass to the customer until Fritz Hansen (or any third party to whom Fritz Hansen has assigned its rights to the purchase price) has received the full purchase price and been reimbursed any expenses incurred.

## WARRANTY

Fritz Hansen provides a standard five-year warranty on standard products within the collections Furniture and Skagerak Collection (Indoor & Outdoor) against defects in materials and workmanship. For the Arne Jacobsen shell chairs (Ant™, Grand Prix™, Lily™, Series 7™), the standard warranty is 10 years. Within the Furniture collection, an extended warranty of up to 10 years is provided on selected products, provided they have been registered online on (see table on the next page for details).

Exception exists for AJ Children's Chairs, Series 7™ Junior, Series 7™ Cushion, Coat Tree™ Wall, Dot™, High Dot™ and AJ Trolley™ which are included in the Accessories warranty terms.

For the Poul Kjørholm collection, the standard warranty is 20 years except for PK0 A™ and PK60™, which is 10 years, and the PK15™, which is 5 years. Wicker and French Cane have a warranty of 2 years.

For the Lighting, Accessories and Skagerak Collection Accessories the standard warranty is 2 years. Specific for the Lighting category: Transformers, ballasts, light sources, and other electronic devices are subject to the warranty terms of the manufacturer in question. Fritz Hansen does not cover costs related to installation and dismantling, replacement of ballasts/transformers and other similar costs related to electricians and the like.

The warranty on all collections does not extend to ordinary tear, wear or of damage to upholstery. On any material, textile, or leather which is not listed in our price lists configured on a specific product, the standard warranty is 2 years. The warranty is void upon subsequent changes to the product.

Additional warranty conditions can be found on

## LIMITATION OF LIABILITY

Fritz Hansen will assume no liability for any loss as a result of delays, defects or any other breach of contract, unless such loss was caused by gross negligence on the part of Fritz Hansen. Fritz Hansen will assume no liability for any indirect loss, including loss of profits, operating loss, goodwill, loss of customers, running costs or any other consequential economic loss.

## CHOICE OF LAW AND JURISDICTION

Disputes between Fritz Hansen and its customers shall be subject to Danish law, except for the international civil law rules of Danish law, and shall be settled by Fritz Hansen's home court.

## MEASUREMENTS

The stated measurements act only as a guideline. The measurements can vary, and size difference on a product can occur.

## FORCE MAJURE

Fritz Hansen is without liability for non-performance of Fritz Hansen's obligations in respect to any orders received, if such non-performance is due to circumstances out of Fritz Hansen's reasonable control, which prevent the fulfilment of the purchase agreement or makes the fulfilment unreasonably burdensome. As examples of such circumstances the following can be mentioned: Industrial dispute and other circumstances which are beyond the control of the parties, such as fire, war, mobilization or calling in for military service of similar extent, requisition, seizure, exchange

controls, riots or disturbances, shortage of means of transportation, ordinary scarcity of goods, restrictions of motive power and defects in or late performance from sub-suppliers due to any of the aforementioned circumstances.

The above circumstances only lead to exemption from liability if their influence on the fulfilment of the purchase agreement could not be anticipated at the conclusion of the agreement. Fritz Hansen must without undue delay notify the customer in writing if any such circumstances, occurrence and cessation, if Fritz Hansen wishes to invoke any grounds of exemption from liability.

Regardless of what follows from these general conditions of sales and delivery, any party is entitled to terminate the purchase agreement by notifying the other party in writing, if the fulfilment of the agreement is prevented for more than 6 months due to one of the above circumstances.

Unless mandatory rules preclude this, Fritz Hansen is in no case liable to the customer for operating losses, lost earnings, or other financial consequential damages under these general conditions for sale and delivery.

## PRIVACY POLICY

At Fritz Hansen, confidentiality and data protection is a high priority. Guidelines for processing of personal data and description of the customer's and end users' rights according to applicable data protection law is governed by Fritz Hansen's privacy policy available on Fritz Hansen's website.

# WARRANTY OVERVIEW

Price list collections	Furniture Collection						Poul Kjærholm Collection				Skagerak Collection		Lighting Collection	Accessories Collection					
	Textiles, Cushions	Leather (1)	Leather (2)	Bases (3)	Bases (4)	Movable parts (5)	Anrt™ Grand Prix™, Lily™, Series 7™	Shells, Tabletops	Tabletops (6)	China Chair™	French Cane, Wicker	PK15™	PKO A™ & PK60™	Poul Kjærholm Collection	Outdoor	Indoor	Lighting	Accessories	Skagerak Collection
2 years										x							x	x	x
5 years	x	x		x		x					x				x	x			
10 years			x*			x*		x*					x**						
20 years									x**				x**						

1. Leather: Soft and Essential
2. Leather: Aura, Rustik, Natural, Grace and Embrace
3. Bases: Lacquered and Wooden (chairs), Powder coated (chairs and tables)
4. Bases: Aluminium, Chrome and Wooden (tables)
5. Moveable parts: Automatic return, Tilt, Height-adjustable, Swivel, Castors and Extension mechanism
6. Tabletops: Lacquer under tabletop, Lacquer on edges and Surface on tabletop

\* Additional with registration

\*\* Standard without registration



**ANT™**  
**ARNE JACOBSEN 1952**

**01.2025**

The Ant™ comes in clear lacquered, coloured ash or lacquered veneer. All chairs are made of pressure moulded veneer and are stackable. The shell is also available in front upholstered versions in a wide range of textiles and leather types. The base comes with 3 or 4 legs made of chromed or powder coated tubular steel.

MODEL	DESCRIPTION	COLOURED VENEER	LACQUERED VENEER	CLEAR LACQUERED VENEER
3100	Chair, 3 legs, stackable (max 8 pcs), seat height 44 cm or 46 cm, chromed or powder coated tubular steel base	280	296	428
3101	Chair, 4 legs, stackable (max 12 pcs), seat height 44 cm or 46 cm, chromed or powder coated tubular steel base	280	296	428

**COLOURED ASH AND LACQUERED VENEER - SEE THE SURFACE SELECTION**  
PALE ROSE (610/615), WILD ROSE (630/635), VENETIAN RED (670/675), PARADISE ORANGE (570/575), BURNT YELLOW (470/475), TRUE YELLOW (460/465), LIGHT BEIGE (130/135), DEEP CLAY (140/145), OLIVE GREEN (920/925), LAVENDER BLUE (810/815), DUSK BLUE (850/855), MIDNIGHT BLUE (890/895), EVERGREEN (950/955), BLACK (190/195), NINE GREY (150/155), WHITE (100/105)

**CLEAR LACQUERED VENEER: - SEE THE SURFACE SELECTION**  
BEECH, CHERRY, ELM, OAK, WALNUT, OAK - DARK STAINED

**BASE COLOURS**  
SILVER GREY, WARM GRAPHITE, BROWN BRONZE, BLACK, WHITE (ONLY WITH WHITE SHELL), CHROME

**FRONT UPHOLSTERED - COLOURED ASH VENEER**

MODEL	DESCRIPTION	CHRISTIANSHAVN	CATEGORY 1	CATEGORY 2	CATEGORY 3	CATEGORY 4	CATEGORY 5
3100	Chair, 3 legs, seat height 44 cm or 46 cm, chromed or powder coated tubular steel base	428	478	511	693	825	1.156
3101	Chair, 4 legs, seat height 44 cm or 46 cm, chromed or powder coated tubular steel base	428	478	511	693	825	1.156

**FRONT UPHOLSTERED - LACQUERED VENEER**

MODEL	DESCRIPTION	CHRISTIANSHAVN	CATEGORY 1	CATEGORY 2	CATEGORY 3	CATEGORY 4	CATEGORY 5
3100	Chair, 3 legs, seat height 44 cm or 46 cm, chromed or powder coated tubular steel base	445	495	528	709	866	1.156
3101	Chair, 4 legs, seat height 44 cm or 46 cm, chromed or powder coated tubular steel base	445	495	528	709	866	1.156

**FRONT UPHOLSTERED - CLEAR LACQUERED VENEER**

MODEL	DESCRIPTION	CHRISTIANSHAVN	CATEGORY 1	CATEGORY 2	CATEGORY 3	CATEGORY 4	CATEGORY 5
3100	Chair, 3 legs, seat height 44 cm or 46 cm, chromed or powder coated tubular steel base	577	619	652	825	990	1.280
3101	Chair, 4 legs, seat height 44 cm or 46 cm, chromed or powder coated tubular steel base	577	619	652	825	990	1.280

**CATEGORY 1:** BELFAST, CANVAS, CAPTURE, DIABLO, FAME, REMIX, TONUS  
**CATEGORY 2:** DIVINA, DIVINA MELANGE, DIVINA MD, FIORD, HALLINGDAL, RE-WOOL, STEELCUT, STEELCUT TRIO, SUNNIVA, VANIR, VIDAR  
**CATEGORY 3:** ESSENTIAL  
**CATEGORY 4:** Soft  
**CATEGORY 5:** Grace, Embrace, Natural  
**SELECTED TEXTILE COLOURS - SEE THE SURFACE SELECTION**  
BELFAST (770593, 770660, 771772, 772062, 772143, 772150, 772255, 774232, 774926, 775139)  
VANIR (193, 243, 373, 393, 413, 443, 473, 693, 733, 773, 913, 983)

DESCRIPTION	PRICE
Linking device for 3101	65
Felt glides (3 or 4 pcs.)	7
Small transport dolly for 8 chairs (3100) or 12 chairs (3101)	395
Large transport dolly for 40 chairs	759
Chair rack, mounted under a table top	57

**3100      3101      SMALL AND LARGE TRANSPORT DOLLY FOR STACKABLE CHAIRS**

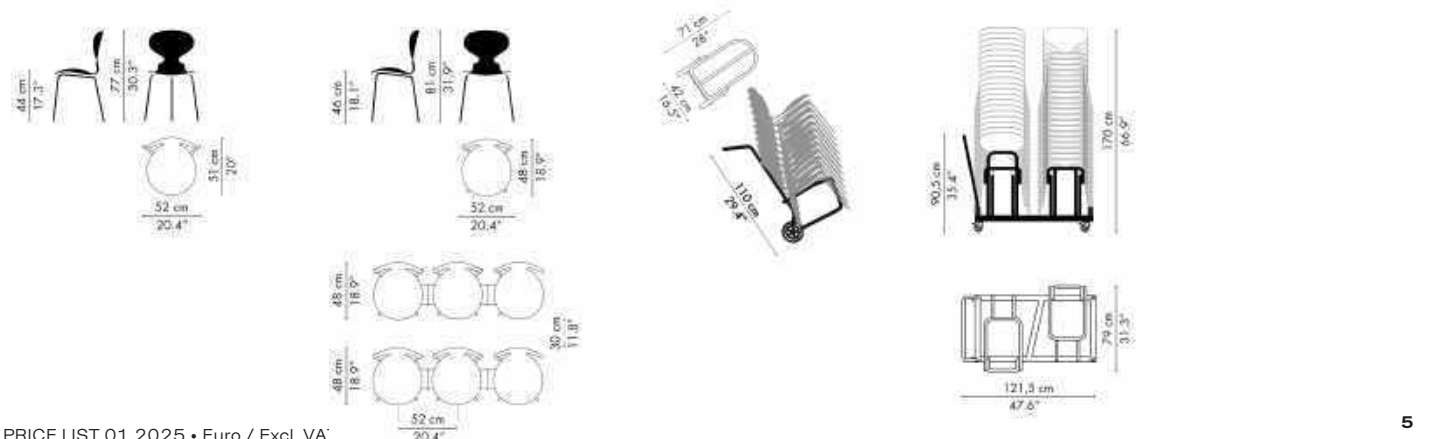



**SERIES 7™**  
**ARNE JACOBSEN 1955**

**01.2025**

The Series 7™ chair comes in three different finishes: Clear lacquered, coloured ash or lacquered veneer. All chairs are made of pressure moulded veneer. The shell is also available in front or fully upholstered versions in a wide range of textiles and leather types. Besides a base with four legs made of tubular steel, it also comes with a height-adjustable swivel base and castors, a counter or a bar stool. The bases of the Series 7™ are available with either a chromed or powder coated finish.

MODEL	DESCRIPTION	COLOURED VENEER	LACQUERED VENEER	CLEAR LACQUERED VENEER
3107	Chair, stackable (max 12 pcs.), seat height 43 cm, 46 cm or 48 cm, chromed or powder coated tubular steel base	395	412	461
3207	Armchair, seat height 43 cm or 46 cm, chromed or powder coated tubular steel base	676	759	800
3187	Counter stool, seat height 64 cm, chromed or powder coated tubular steel base	569	594	627
3197	Bar stool, seat height 76 cm, chromed or powder coated tubular steel base	569	594	627
3117	Swivel chair, adjustable seat height 44-56 cm, 5 castors, chromed or powder coated tubular steel base	908	908	990
3217	Swivel armchair, adjustable seat height 44-56 cm, 5 castors, chromed or powder coated tubular steel base	1.156	1.238	1.321

**COLOURED ASH AND LACQUERED VENEER - SEE THE SURFACE SELECTION**

PALE ROSE (610/615), WILD ROSE (630/635), VENETIAN RED (670/675), PARADISE ORANGE (570/575), BURNT YELLOW (470/475), TRUE YELLOW (460/465), LIGHT BEIGE (130/135), DEEP CLAY (140/145), OLIVE GREEN (920/925), LAVENDER BLUE (810/815), DUSK BLUE (850/855), MIDNIGHT BLUE (890/895), EVERGREEN (950/955), BLACK (190/195), NINE GREY (150/155), WHITE (100/105)

**CLEAR LACQUERED VENEER: - SEE THE SURFACE SELECTION**

BEECH, CHERRY, ELM, OAK, WALNUT, OAK - DARK STAINED

**BASE COLOURS**

SILVER GREY, WARM GRAPHITE, BROWN BRONZE, BLACK, WHITE (ONLY WITH WHITE SHELL & NOT AVAILABLE FOR MODELS WITH SWIVEL BASE; 3117 & 3217), CHROME

**FRONT UPHOLSTERED - COLOURED ASH VENEER**

MODEL	DESCRIPTION	CHRISTIANSHAVN	CATEGORY 1	CATEGORY 2	CATEGORY 3	CATEGORY 4	CATEGORY 5
3107	Chair, seat height 43 cm, 46 cm or 48 cm, chromed or powder coated tubular steel base	561	610	643	776	866	990
3207	Armchair, seat height 43 cm or 46 cm, chromed or powder coated tubular steel base	825	908	908	949	1.073	1.156
3187	Counter stool, seat height 64 cm, chromed or powder coated tubular steel base	734	776	817	949	1.073	1.156
3197	Bar stool, seat height 76 cm, chromed or powder coated tubular steel base	734	776	817	949	1.073	1.156
3117	Swivel chair, adjustable seat height 44-56 cm, 5 castors, chromed or powder coated tubular steel base	1.073	1.114	1.156	1.280	1.362	1.486
3217	Swivel armchair, adjustable seat height 44-56 cm, 5 castors, chromed or powder coated tubular steel base	1.321	1.362	1.404	1.445	1.569	1.734

**FRONT UPHOLSTERED - LACQUERED VENEER**

MODEL	DESCRIPTION	CHRISTIANSHAVN	CATEGORY 1	CATEGORY 2	CATEGORY 3	CATEGORY 4	CATEGORY 5
3107	Chair, seat height 43 cm, 46 cm or 48 cm, chromed or powder coated tubular steel base	577	619	660	800	908	990
3207	Armchair, seat height 43 cm or 46 cm, chromed or powder coated tubular steel base	949	990	990	1.073	1.114	1.238
3187	Counter stool, seat height 64 cm, chromed or powder coated tubular steel base	759	792	825	990	1.073	1.156
3197	Bar stool, seat height 76 cm, chromed or powder coated tubular steel base	759	792	825	990	1.073	1.156
3117	Swivel chair, adjustable seat height 44-56 cm, 5 castors, chromed or powder coated tubular steel base	1.114	1.156	1.197	1.362	1.362	1.486
3217	Swivel armchair, adjustable seat height 44-56 cm, 5 castors, chromed or powder coated tubular steel base	1.404	1.486	1.486	1.528	1.734	1.817

**FRONT UPHOLSTERED - CLEAR LACQUERED VENEER**

MODEL	DESCRIPTION	CHRISTIANSHAVN	CATEGORY 1	CATEGORY 2	CATEGORY 3	CATEGORY 4	CATEGORY 5
3107	Chair, seat height 43 cm, 46 cm or 48 cm, chromed or powder coated tubular steel base	652	693	726	866	990	1.114
3207	Armchair, seat height 43 cm or 46 cm, chromed or powder coated tubular steel base	990	1.073	1.073	1.114	1.238	1.321
3187	Counter stool, seat height 64 cm, chromed or powder coated tubular steel base	825	866	908	1.073	1.156	1.280
3197	Bar stool, seat height 76 cm, chromed or powder coated tubular steel base	825	866	908	1.073	1.156	1.280
3117	Swivel chair, adjustable seat height 44-56 cm, 5 castors, chromed or powder coated tubular steel base	1.156	1.238	1.238	1.404	1.486	1.569
3217	Swivel armchair, adjustable seat height 44-56 cm, 5 castors, chromed or powder coated tubular steel base	1.486	1.528	1.569	1.652	1.734	1.900

**CATEGORY 1: BELFAST, CANVAS, CAPTURE, DIABLO, FAME, REMIX, TONUS**

**CATEGORY 2: DIVINA, DIVINA MELANGE, DIVINA MD, FIORD, HALLINGDAL, RE-WOOL, STEELCUT, STEELCUT TRIO, SUNNIVA, VANIR**

**CATEGORY 3: ESSENTIAL**

**CATEGORY 4: SOFT**

**CATEGORY 5: GRACE, EMBRACE, NATURAL**

**SELECTED TEXTILE COLOURS - SEE THE SURFACE SELECTION**

BELFAST (770593, 770660, 771772, 772062, 772143, 772150, 772255, 774232, 774926, 775139)  
VANIR (193, 243, 373, 393, 413, 443, 473, 693, 733, 773, 913, 983)



FULLY UPHOLSTERED

MODEL	DESCRIPTION	CHRISTIANSHAVN	CATEGORY 1	CATEGORY 2	CATEGORY 3	CATEGORY 4	CATEGORY 5
3107	Chair, seat height 43 cm, 46 cm or 48 cm, chromed or powder coated tubular steel base	652	676	718	949	990	1.156
3207	Armchair, seat height 43 cm or 46 cm, chromed or powder coated tubular steel base	908	949	990	1.114	1.238	1.321
3187	Counter stool, seat height 64 cm, chromed or powder coated tubular steel base	866	908	949	1.156	1.238	1.404
3197	Bar stool, seat height 76 cm, chromed or powder coated tubular steel base	866	908	949	1.156	1.238	1.404
3117	Swivel chair, adjustable seat height 44-56 cm, 5 castors, chromed or powder coated tubular steel base	1.073	1.156	1.197	1.362	1.404	1.569
3217	Swivel armchair, adjustable seat height 44-56 cm, 5 castors, chromed or powder coated tubular steel base	1.404	1.445	1.528	1.652	1.734	1.900

CATEGORY 1: BELFAST, CANVAS, CAPTURE, DIABLO, FAME, REMIX, TONUS

CATEGORY 2: DIVINA, DIVINA MELANGE, DIVINA MD, FIORD, HALLINGDAL, RE-WOOL, STEELCUT, STEELCUT TRIO, SUNNIVA, VANIR

CATEGORY 3: ESSENTIAL

CATEGORY 4: SOFT

CATEGORY 5: GRACE, EMBRACE, NATURAL

SELECTED TEXTILE COLOURS - SEE THE SURFACE SELECTION

BELFAST (770593, 770660, 771772, 772062, 772143, 772150, 772255, 774232, 774926, 775139)

VANIR (193, 243, 373, 393, 413, 443, 473, 693, 733, 773, 913, 983)

OPTIONS

DESCRIPTION	PRICE
Hard castors for soft floors with or without brake	No surcharge
Soft castor for hard floors with or without brake	No surcharge
Linking device for 3107, short	65
Linking device for 3107 w/writing tablet and 3207, long	65
Writing tablet for 3107, fold-away, white laminated surface, chromed arm	296
Writing tablet for 3107, coloured veneer: black, chromed arm (Other colors are made to order, MOQ: 25 pcs)	296
Small transport dolly for 12 pcs. 3107 chairs, non-upholstered	395
Large transport dolly for 40 pcs. 3107 chairs, non-upholstered	759
Felt glides (4 pcs.)	7
Chair rack for 3107 chairs, mounted under a table top, for non-upholstered chairs only	57
3107SC Seat cushion, Wild leather, walnut (colli 4 pcs)	98
3107SC Seat cushion, Raw leather, black (colli 4 pcs)	65
3107SC Seat cushion, Intense leather, brown (colli 4 pcs.)	65



3107

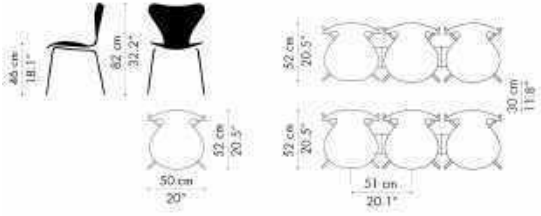

3107 WITH WRITING TABLET

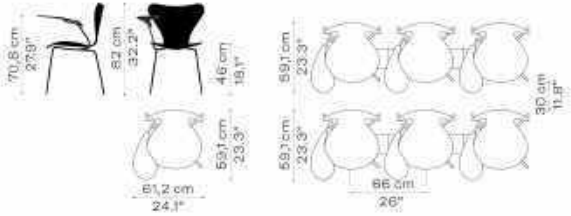

3207

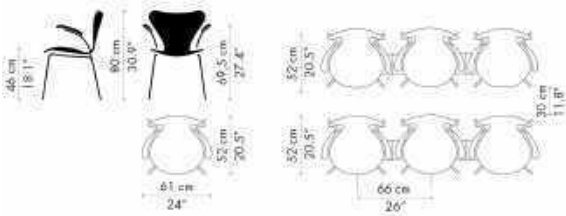

3117

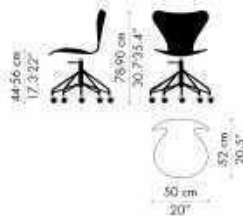

3217

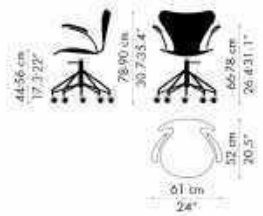

3187



3197



SMALL AND LARGE TRANSPORT DOLLY FOR STACKABLE CHAIRS

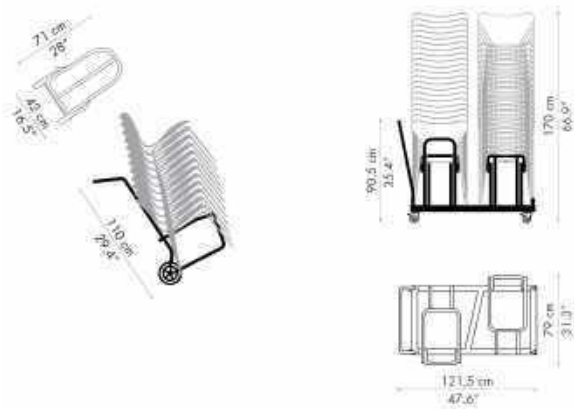





## CHILDREN'S CHAIRS / JUNIOR ARNE JACOBSEN 2005/2019

01.2025

The Children's Chairs are available in three variants: Coloured ash veneer (Wild Rose and Midnight Blue) and clear lacquered Oregon Pine. The base comes with 4 legs (stackable) and is made of chromed steel tubes. The Junior chair is available in clear lacquered oak veneer or black coloured ash veneer with a chromed steel base, coloured ash veneer in Evergreen or Burned Yellow with a Brown Bronze base.

### CHILDREN'S CHAIRS / JUNIOR

MODEL	DESCRIPTION	PRICE
840224	Ant™ Children's Chair, stackable (max 10 pcs.), seat height 34 cm, Midnight Blue (895), chromed tubular steel base - colli 1 (2 pcs)	263
840225	Ant™ Children's Chair, stackable (max 10 pcs.), seat height 34 cm, Wild Rose (635), chromed tubular steel base - colli 1 (2 pcs)	263
840226	Ant™ Children's Chair, stackable (max 10 pcs.), seat height 34 cm, Oregon Pine, chromed tubular steel base - colli 1 (2 pcs)	263
840221	Grand Prix™ Children's Chair, stackable (max 10 pcs.), seat height 34 cm, Midnight Blue (895), chromed tubular steel base - colli 1 (2 pcs)	263
840222	Grand Prix™ Children's Chair, stackable (max 10 pcs.), seat height 34 cm, Wild Rose (635), chromed tubular steel base - colli 1 (2 pcs)	263
840223	Grand Prix™ Children's Chair, stackable (max 10 pcs.), seat height 34 cm, Oregon Pine, chromed tubular steel base - colli 1 (2 pcs)	263
840243	Lily™ Children's Chair, stackable (max 10 pcs.), seat height 34 cm, Midnight Blue (895), chromed tubular steel base - colli 1 (2 pcs)	263
840242	Lily™ Children's Chair, stackable (max 10 pcs.), seat height 34 cm, Wild Rose (635), chromed tubular steel base - colli 1 (2 pcs)	263
840241	Lily™ Children's Chair, stackable (max 10 pcs.), seat height 34 cm, Oregon Pine, chromed tubular steel base - colli 1 (2 pcs)	263
840227	Series 7™ Children's Chair, stackable (max 10 pcs.), seat height 34 cm, Midnight Blue (895), chromed tubular steel base - colli 1 (2 pcs)	263
840228	Series 7™ Children's Chair, stackable (max 10 pcs.), seat height 34 cm, Wild Rose (635), chromed tubular steel base - colli 1 (2 pcs)	263
840229	Series 7™ Children's Chair, stackable (max 10 pcs.), seat height 34 cm, Oregon Pine, chromed tubular steel base - colli 1 (2 pcs)	263
840236	Junior chair, seat height 52 cm, Black, chromed tubular steel base	313
840237	Junior chair, seat height 52 cm, Oak veneer, chromed tubular steel base	313
840238	Junior chair, seat height 52, Burnt Yellow, Brown Bronze powder coated tubular steel base	313
840239	Junior chair, seat height 52, Evergreen, Brown Bronze powder coated tubular steel base	313

#### ANT™ CHILDREN'S CHAIR



#### GRAND PRIX™ CHILDREN'S CHAIR

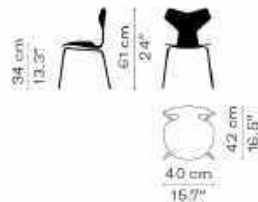

#### LILY™ CHILDREN'S CHAIR



#### SERIES 7™ CHILDREN'S CHAIR



#### SERIES 7™ JUNIOR





**DOT™ / HIGH DOT™**  
ARNE JACOBSEN 1954

01.2025

The Dot™ and the High Dot™ stools are available in selected leather and veneer variants: Black coloured ash or clear lacquered walnut. All stools come with four legs, while the High Dot™ Counter also comes with a three-legged base. The bases are made of chromed or powder coated tubular steel.

**DOT™, 46CM**

MODEL	DESCRIPTION	PRICE
840128	4 legs, black coloured ash (195), chromed tubular steel base	222
840132	4 legs, Walnut veneer, chromed tubular steel base	222
840105	4 legs, Intense matt black leather, black powder coated tubular steel base	271
840100	4 legs, Wild Walnut leather, chromed tubular steel base	271

**HIGH DOT™ COUNTER, 65 CM**

MODEL	DESCRIPTION	PRICE
840129	3 legs, black coloured ash (195), chromed tubular steel base	304
840133	3 legs Walnut veneer, chromed tubular steel base	304
840106	3 legs, Intense matt black leather, black powder coated tubular steel base	354
840107	3 legs, Walnut leather, chromed tubular steel base	354
840130	4 legs, black coloured ash (195), chromed tubular steel base	304
840134	4 legs, Walnut veneer, chromed tubular steel base	304
840136	4 legs, Intense Matt black leather, black powder coated tubular steel base	346
840138	4 legs, Wild Walnut leather, chromed tubular steel base	346

**HIGH DOT™ BAR, 76 CM**

MODEL	DESCRIPTION	PRICE
840131	4 legs, black coloured ash (195), chromed tubular steel base	304
840135	4 legs, Walnut veneer, chromed tubular steel base	304
840137	4 legs, Intense Matt black leather, black powder coated tubular steel base	346
840139	4 legs, Wild leather Walnut, chromed tubular steel base	346

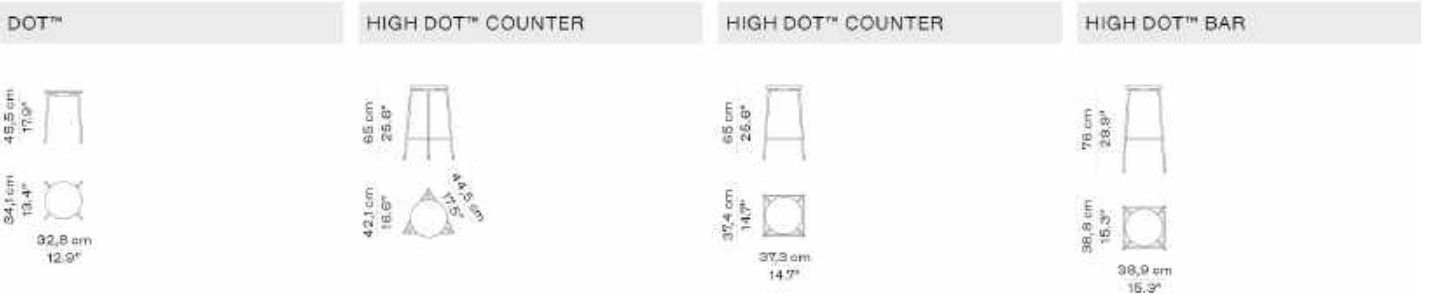



**GRAND PRIX™**  
ARNE JACOBSEN 1957

01.2025

The Grand Prix™ comes in clear lacquered (oak or walnut), coloured ash or lacquered (only 3130) veneer. All chairs are made of pressure moulded veneer. Front upholstery or full upholstery is available in a wide range of textiles and leather types. The base comes with four legs in several variants: Chromed or powder coated tubular steel (stackable max 5 pcs.) and wooden legs (non-stackable). Besides a base with four legs made of tubular steel, it also comes with a height-adjustable swivel base and castors, a counter or a bar stool.

MODEL	DESCRIPTION	COLOURED VENEER	LACQUERED VENEER	CLEAR LACQUERED VENEER
3130	Chair, stackable (max 5 pcs.), seat height 43 cm, 46 cm or 48 cm, chromed or powder coated tubular steel base	395	412	461
4130	Chair, seat height 44 cm or 46 cm, wooden legs	552		577
3138	Counter stool, seat height 64 cm, chromed or powder coated tubular steel base	544	552	594
3139	Bar stool, seat height 76 cm, chromed or powder coated tubular steel base	544	552	594
3131	Swivel chair, adjustable seat height 44-56 cm, 5 castors, chromed or powder coated tubular steel base	825	908	908

COLOURED ASH AND LACQUERED VENEER - SEE THE SURFACE SELECTION  
PALE ROSE (610/615), WILD ROSE (630/635), VENETIAN RED (670/675), PARADISE ORANGE (570/575), BURNT YELLOW (470/475), TRUE YELLOW (460/465), LIGHT BEIGE (130/135), DEEP CLAY (140/145), OLIVE GREEN (920/925), LAVENDER BLUE (810/815), DUSK BLUE (850/855), MIDNIGHT BLUE (890/895), EVERGREEN (950/955), BLACK (190/195), NINE GREY (150/155), WHITE (100/105)

CLEAR LACQUERED VENEER: - SEE THE SURFACE SELECTION  
OAK, WALNUT

BASE COLOURS  
3130, 3131, 3138, 3139: SILVER GREY, WARM GRAPHITE, BROWN BRONZE, BLACK, WHITE (ONLY WITH WHITE SHELL & NOT AVAILABLE FOR MODELS WITH SWIVEL BASE; 3131), CHROME  
4130\*: OAK, WALNUT, BLACK, WHITE (ONLY WITH WHITE SHELL)

[\*OAK/WALNUT VENEER SHELLS ARE ONLY AVAILABLE WITH MATCHING WOODEN BASE]

**FRONT UPHOLSTERED - COLOURED ASH VENEER**

MODEL	DESCRIPTION	CHRISTIANSHAVN	CATEGORY 1	CATEGORY 2	CATEGORY 3	CATEGORY 4	CATEGORY 5
3130	Chair, stackable (max 5 pcs.), seat height 43 cm, 46 cm or 48 cm, chromed or powder coated tubular steel base	561	610	643	784	866	990
4130	Chair, seat height 43 cm or 46 cm, wooden legs	718	767	800	949	1.032	1.156
3138	Counter stool, seat height 64 cm, chromed or powder coated tubular steel base	701	742	776	908	990	1.114
3139	Bar stool, seat height 76 cm, chromed or powder coated tubular steel base	701	742	776	908	990	1.114
3131	Swivel chair, adjustable seat height 44-56 cm, 5 castors, chromed or powder coated tubular steel base	990	1.073	1.073	1.238	1.321	1.445

**FRONT UPHOLSTERED - LACQUERED VENEER**

MODEL	DESCRIPTION	CHRISTIANSHAVN	CATEGORY 1	CATEGORY 2	CATEGORY 3	CATEGORY 4	CATEGORY 5
3130	Chair, stackable (max 5 pcs.), seat height 43 cm, 46 cm or 48 cm, chromed or powder coated tubular steel base	577	619	660	800	908	990
3138	Counter stool, seat height 64 cm, chromed or powder coated tubular steel base	709	759	792	949	990	1.114
3139	Bar stool, seat height 76 cm, chromed or powder coated tubular steel base	709	759	792	949	990	1.114
3131	Swivel chair, adjustable seat height 44-56 cm, 5 castors, chromed or powder coated tubular steel base	1.073	1.073	1.114	1.321	1.445	1.734

**FRONT UPHOLSTERED - CLEAR LACQUERED VENEER**

MODEL	DESCRIPTION	CHRISTIANSHAVN	CATEGORY 1	CATEGORY 2	CATEGORY 3	CATEGORY 4	CATEGORY 5
3130	Chair, stackable (max 5 pcs.), seat height 43 cm, 46 cm or 48 cm, chromed or powder coated tubular steel base	652	693	726	866	990	1.114
4130	Chair, seat height 43 cm or 46 cm, wooden legs	742	784	825	949	1.032	1.156
3138	Counter stool, seat height 64 cm, chromed or powder coated tubular steel base	784	825	866	990	1.114	1.156
3139	Bar stool, seat height 76 cm, chromed or powder coated tubular steel base	784	825	866	990	1.114	1.156
3131	Swivel chair, adjustable seat height 44-56 cm, 5 castors, chromed or powder coated tubular steel base	1.114	1.156	1.197	1.362	1.486	1.817

CATEGORY 1: CANVAS, CAPTURE, DIABLO, FAME, REMIX, TONUS  
CATEGORY 2: DIVINA, DIVINA MELANGE, DIVINA MD, FIORD, HALLINGDAL, RE-WOOL, STEELCUT, STEELCUT TRIO, SUNNIVA, VANIR  
CATEGORY 3: ESSENTIAL  
CATEGORY 4: SOFT  
CATEGORY 5: GRACE, EMBRACE, NATURAL

SELECTED TEXTILE COLOURS - SEE THE SURFACE SELECTION  
VANIR (193, 243, 373, 393, 413, 443, 473, 693, 733, 773, 913, 983)



FULLY UPHOLSTERED

MODEL	DESCRIPTION	CHRISTIANSHAVN	CATEGORY 1	CATEGORY 2	CATEGORY 3	CATEGORY 4	CATEGORY 5
3130	Chair, seat height 43 cm, 46 or 48 cm, chromed or powder coated tubular steel base	652	676	718	949	990	1.156
4130	Chair, seat height 43 cm or 46 cm, wooden legs	809	866	908	1.073	1.156	1.321
3138	Counter stool, seat height 64 cm, chromed or powder coated tubular steel base	825	866	908	1.114	1.156	1.321
3139	Bar stool, seat height 76 cm, chromed or powder coated tubular steel base	825	866	908	1.114	1.156	1.321
3131	Swivel chair, adjustable seat height 44-56 cm, 5 castors, chromed or powder coated tubular steel base	1.032	1.073	1.156	1.321	1.569	1.817

CATEGORY 1: CANVAS, CAPTURE, DIABLO, FAME, REMIX, TONUS  
 CATEGORY 2: DIVINA, DIVINA MELANGE, DIVINA MD, FIORD, HALLINGDAL, RE-WOOL, STEELCUT, STEELCUT TRIO, SUNNIVA, VANIR  
 CATEGORY 3: ESSENTIAL  
 CATEGORY 4: SOFT  
 CATEGORY 5: GRACE, EMBRACE, NATURAL

SELECTED TEXTILE COLOURS - SEE THE SURFACE SELECTION  
 VANIR (193, 243, 373,393, 413, 443, 473, 693, 733, 773, 913, 983)

OPTIONS

DESCRIPTION	PRICE
Hard castors for soft floors with or without brake	No surcharge
Soft castor for hard floors with or without brake	No surcharge
Linking device for 3130 chairs	65
Small transport dolly for 5 pcs. 3130 chairs, non-upholstered	395
Chair rack for 3130 chairs, mounted under a table top, for non-upholstered chairs only	57
Felt glides (4 pcs.)	7



3130

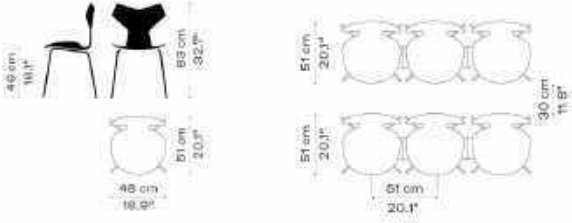

4130



3131

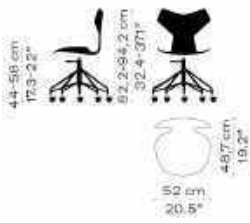

3138



3139



SMALL TRANSPORT DOLLY FOR STACKABLE CHAIRS





The Lily™ chair comes in two variants; with or without arms, in clear lacquered walnut veneer or fully upholstered in a wide range of textiles and leather types. All chairs are made of pressure moulded veneer. The base comes with four legs made of chromed tubular steel.

MODEL	DESCRIPTION	CLEAR LACQUERED WALNUT
3108	Chair, stackable, seat height 43 cm or 46 cm, chromed tubular steel base	594
3208	Armchair, seat height 43 cm or 46 cm, chromed tubular steel base	1.073

FULLY UPHOLSTERED

MODEL	DESCRIPTION	CHRISTIANSHAVN	CATEGORY 1	CATEGORY 2	CATEGORY 3	CATEGORY 4	CATEGORY 5
3108	Chair, seat height 43 cm or 46 cm, chromed tubular steel base	1.073	1.114	1.114	1.445	1.569	1.982
3208	Armchair, seat height 43 cm or 46 cm, chromed tubular steel base	2.230	2.395	2.395	2.478	2.643	2.891

CATEGORY 1: CANVAS, CAPTURE, DIABLO, FAME, REMIX, TONUS  
 CATEGORY 2: DIVINA, DIVINA MELANGE, DIVINA MD, FIORD, HALLINGDAL, RE-WOOL, STEELCUT, STEELCUT TRIO, SUNNIVA, VANIR  
 CATEGORY 3: ESSENTIAL  
 CATEGORY 4: SOFT  
 CATEGORY 5: GRACE, EMBRACE, NATURAL

SELECTED TEXTILE COLOURS - SEE THE SURFACE SELECTION  
 VANIR (193, 243, 373,393, 413, 443, 473, 693, 733, 773, 913, 983)

OPTIONS

DESCRIPTION	PRICE
Felt glides (4 pcs.)	7
Linking device for 3108	65
Small transport dolly for 8 pcs. 3108 chairs, non-upholstered	395
Chair rack for 3108 chairs, mounted under a table top, for non-upholstered chairs only	57

3108

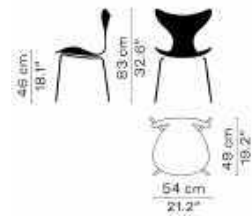

3208

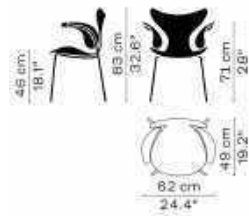

SMALL TRANSPORT DOLLY





**DROP™**  
ARNE JACOBSEN 1958/2014

01.2025

The Drop™ chair comes with a shell made of ABS plastic and four legs in chromed or powder coated tubular steel. The chair is also available upholstered in a wide range of textile and leather types.

**PLASTIC**

MODEL	DESCRIPTION	PLASTIC (ABS)
3110	Chair, 43 cm or 46 cm, chromed or powder coated tubular steel base	296

PLASTIC COLOURS - SEE THE SURFACE SELECTION  
DEEP CLAY, LIGHT BEIGE, PALE ROSE, OLIVE GREEN, BLACK, WHITE

BASE COLOURS  
WARM GRAPHITE, BROWN BRONZE, BLACK, WHITE (ONLY WITH WHITE SHELL), CHROME

**FULLY UPHOLSTERED**

MODEL	DESCRIPTION	CHRISTIANSHAVN	CATEGORY 1	CATEGORY 2	CATEGORY 3	CATEGORY 4	CATEGORY 5
3110	Chair, 43 cm or 46 cm, handstitched, chromed or powder coated tubular steel base	908	949	990	1.569	1.734	2.065
3110UB	Chair, 43 cm or 46 cm, Essential leather with front stitching and piping, chrome or powder coated tubular steel base				990		

CATEGORY 1: CANVAS, CAPTURE, DIABLO, FAME, REMIX, TONUS  
CATEGORY 2: DIVINA, DIVINA MELANGE, DIVINA MD, FIORD, HALLINGDAL, RE-WOOL, STEELCUT, STEELCUT TRIO, SUNNIVA  
CATEGORY 3: ESSENTIAL  
CATEGORY 4: AURA  
CATEGORY 5: GRACE, EMBRACE, NATURAL

**OPTIONS**

DESCRIPTION	PRICE
Felt glides (4 pcs.)	7
3110SC Seat cushion, Salsa 3 textile, grey (36)	52
3110SC Seat cushion, Salsa 3 textile, black (39)	52

3110/3110UB

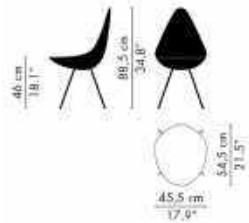



**LITTLE GIRAFFE™**  
**ARNE JACOBSEN 1959/2018**

**01.2025**

The Little Giraffe™ chair is upholstered with either a fixed or a removable cover in a wide selection of textiles and leather types. Seat and backrest of the chair are made from PUR-foam moulded around an inner steel frame. Its base is available either with four tubular steel legs or a five-star base made of die-cast aluminium.

MODEL	DESCRIPTION	CHRISTIANSHAVN	CATEGORY 1	CATEGORY 2	CATEGORY 3	CATEGORY 4	CATEGORY 5
3201	Chair, fixed cover, 4 legs, chromed or black powder coated tubular steel base	1.073	1.114	1.156	1.817	1.982	2.147
3201R	Chair, removable cover, 4 legs, chromed or black powder coated tubular steel base	1.156	1.197	1.280			
3211	Swivel chair, fixed cover, height-adjustable, satin brushed or black powder coated aluminium base, 5 castors	1.073	1.114	1.156	1.817	1.982	2.147
3211R	Swivel chair, removable cover, height-adjustable, satin brushed or black powder coated aluminium base, 5 castors	1.156	1.238	1.280			
32C	Removable cover, in textile only	304	321	362			

CATEGORY 1: CANVAS, CAPTURE, DIABLO, FAME, REMIX, TONUS  
 CATEGORY 2: DIVINA, DIVINA MELANGE, DIVINA MD, FIORD, HALLINGDAL, RE-WOOL, STEELCUT, STEELCUT TRIO, SUNNIVA  
 CATEGORY 3: ESSENTIAL  
 CATEGORY 4: AURA  
 CATEGORY 5: GRACE, EMBRACE, NATURAL

BASE COLOURS  
 3201, 3201R: BLACK, CHROME  
 3211, 3211R: BLACK, BRUSHED ALUMINIUM

**OPTIONS**

DESCRIPTION	PRICE
Hard castors for soft floors with or without brake	No surcharge
Soft castor for hard floors with or without brake	No surcharge

3201



3211







**OXFORD™**  
**ARNE JACOBSEN 1965**

01.2025

The Oxford™ chair comes fully upholstered in a wide range of textile or leather types and is available with a low or medium back, with or without armrests. The inner shell of the chair is made of a pressure moulded veneer shell covered with cut HR foam. The base of the chair is made of die-cast aluminium and available either as a fixed four-star or five-star base with or without castors, either fixed or height adjustable with tilt mechanism. The bases come in two finishes; satin brushed or powder coated aluminium, while the five-star base is also optionally available in mirror chrome. Optional comfort-enhancing arm pads are available for armrest configurations.

**4-STAR BASE**

MODEL	DESCRIPTION	CHRISTIANSHAVN	CATEGORY 1	CATEGORY 2	CATEGORY 3	CATEGORY 4	CATEGORY 5
3141T	Chair, low back, fixed seat height, toes	1.734	1.817	1.941	2.230	2.561	3.470
3143T	Chair, medium back, fixed seat height, toes	1.941	2.065	2.147	2.478	2.809	3.800
3241T	Armchair, low back, fixed seat height, toes	1.941	2.065	2.147	2.395	2.809	3.718
3243T	Armchair, medium back, fixed seat height, toes	2.147	2.230	2.395	2.643	3.057	4.048

**5-STAR BASE**

MODEL	DESCRIPTION	CHRISTIANSHAVN	CATEGORY 1	CATEGORY 2	CATEGORY 3	CATEGORY 4	CATEGORY 5
3171T	Chair, low back, fixed seat height, glides or toes	1.900	1.982	2.065	2.313	2.643	3.635
3173T	Chair, medium back, fixed height, glides or toes	2.065	2.230	2.313	2.643	2.974	3.966
3191T	Chair, low back, height adjustable, tilt, glides or toes	1.941	2.065	2.147	2.395	2.726	3.718
3193T	Chair, medium back, height adjustable, tilt, glides or toes	2.147	2.230	2.395	2.643	3.057	4.048
3271T	Armchair, low back, fixed seat height, glides or toes	2.065	2.230	2.313	2.561	2.891	3.883
3273T	Armchair, medium back, fixed seat height, glides or toes	2.313	2.395	2.478	2.809	3.139	4.131
3291T	Armchair, low back, height adjustable, tilt, glides or toes	2.147	2.230	2.395	2.643	2.974	3.883
3293T	Armchair, medium back, height adjustable, tilt, glides or toes	2.395	2.478	2.561	2.891	3.222	4.214

**5-STAR BASE WITH CASTORS**

MODEL	DESCRIPTION	CHRISTIANSHAVN	CATEGORY 1	CATEGORY 2	CATEGORY 3	CATEGORY 4	CATEGORY 5
3171W	Chair, low back, fixed seat height, castors	2.147	2.230	2.395	2.643	2.974	3.883
3173W	Chair, medium back, fixed seat height, castors	2.395	2.478	2.561	2.891	3.222	4.214
3191W	Chair, low back, height adjustable, tilt, castors	2.230	2.313	2.478	2.726	3.057	3.966
3193W	Chair, medium back, height adjustable, tilt, castors	2.395	2.561	2.643	2.974	3.304	4.296
3271W	Armchair, low back, fixed seat height, castors	2.395	2.478	2.561	2.809	3.139	4.131
3273W	Armchair, medium back, fixed seat height, castors	2.561	2.643	2.809	3.057	3.470	4.461
3291W	Armchair, low back, height adjustable, tilt, castors	2.478	2.561	2.643	2.891	3.222	4.214
3293W	Armchair, medium back, height adjustable, tilt, castors	2.643	2.726	2.891	3.139	3.470	4.544

CATEGORY 1: TONUS  
 CATEGORY 2: DIVINA, DIVINA MELANGE, DIVINA MD, FIORD, HALLINGDAL, STEELCUT, STEELCUT TRIO, SUNNIVA, RE-WOOL, VIDAR  
 CATEGORY 3: ESSENTIAL, SONAR  
 CATEGORY 4: SOFT  
 CATEGORY 5: GRACE, EMBRACE, NATURAL

BASE COLOURS: BROWN BRONZE, BLACK, SATIN BRUSHED ALUMINIUM

**OPTIONS**

DESCRIPTION	PRICE
Hard castors for soft floors with or without brake	No surcharge
Soft castor for hard floors with or without brake	No surcharge
Automatic return for chairs with fixed seat height	156
Arm pads in black plastic for chairs upholstered in textile	61
Arm pads in matching leather for chairs upholstered in leather	180
Mirror chromed base (5-star bases)	98
Mirror chromed base and armrests (5-star bases)	197



3141T

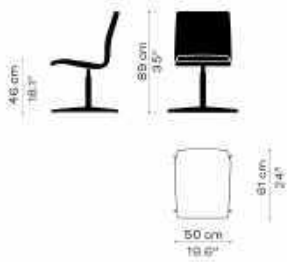

3143T

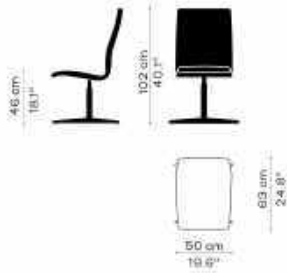

3241T

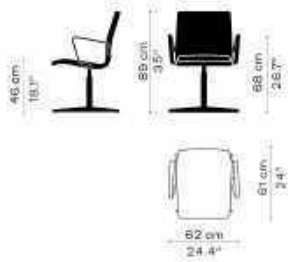

3243T



3171T

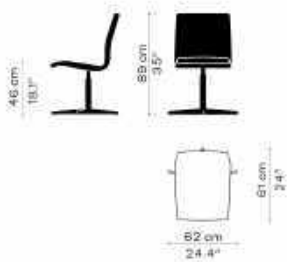

3173T

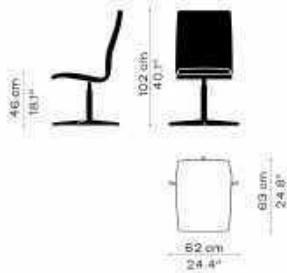

3191T



3193T

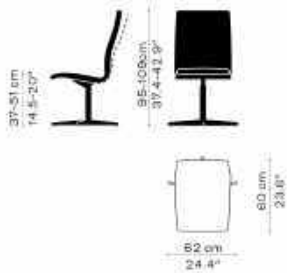

3271T



3273T



3291T



3293T



3171W

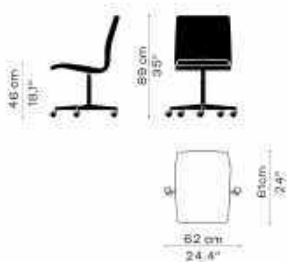

3173W



3191W

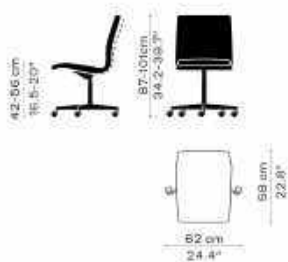

3193W

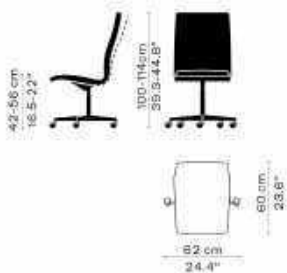

3271W

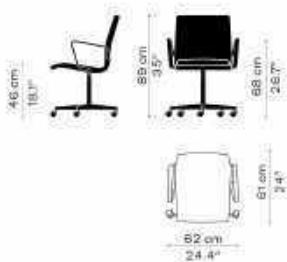

3273W

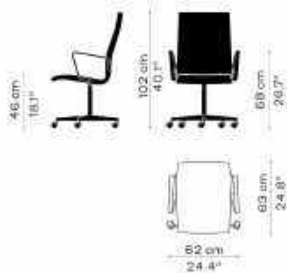

3291W



3293W

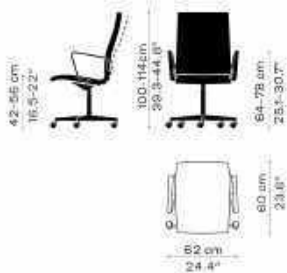



## NO2™ RECYCLE NENDO 2019

01.2025

NO2™ Recycle is made from recycled plastic (PP) from household waste. It is available in seven shell colours with four legs made of tubular steel, a sledge base made of solid steel or a die-cast aluminium swivel base. The NO2™ Recycle is also configurable as counter or bar stool with a four-legged base. The chair is available with an optional seat cushion in textile, mounted or sold separately.

MODEL	DESCRIPTION	RECYCLED PLASTIC (PP)
N02-10	Chair, stackable (max 10 pcs.), seat height 46 cm, 4 legs, chromed or powder coated tubular steel	263
N02-11	Armchair, stackable (max 10 pcs.), seat height 46 cm, 4 legs, chromed or powder coated tubular steel	346
N02-20	Chair, stackable (max 10 pcs.), seat height 46 cm, chromed solid steel sledge base	263
N02-21	Chair w/welded linking device, stackable (max 10 pcs.), seat height 46 cm, chromed steel sledge base	304
N02-30	Swivel chair, polished aluminium base, 5 castors	461
N02-31	Swivel armchair, polished aluminium base, 5 castors	552
N02-40	Counter stool, stackable (max 4 pcs.), seat height 64 cm, chromed or powder coated tubular steel base	313
N02-50	Bar stool, stackable (max 4 pcs.), seat height 76 cm, chromed or powder coated tubular steel base	371

SHELL AND BASE COLOURS  
OFF WHITE, GREY, BLACK, DARK ORANGE, DARK RED, LIGHT BLUE, DARK BLUE

### OPTIONS

DESCRIPTION	PRICE
Hard castors for soft floors with or without brake	No surcharge
Soft castor for hard floors with or without brake	No surcharge
N02-70 Seat cushion, Just textile in black (60999), dark grey (60121) or light grey (60118)	57
Linking device for N02-20	32
Felt glides (4 pcs.)	7
Small transport dolly for 10 pcs. N02-10, N02-11 or N02-20 chairs	395
Chair rack for N02 chairs, mounted under a table top	57

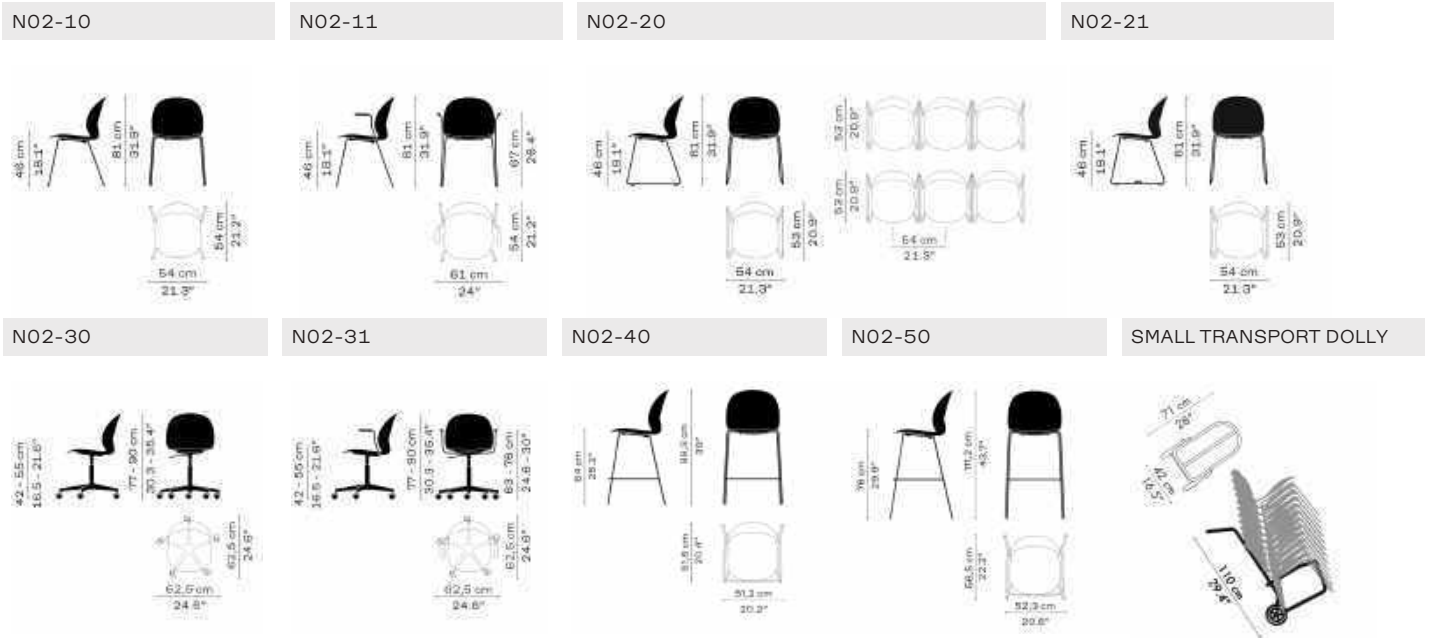

#### CERTIFICATION

The NO2™ Recycle models N02-10 and N02-11 with powder coated legs have achieved the EU-Ecolabel.





**VICO DUO™**  
VICO MAGISTRETTI 1997/2020

01.2025

The Vico Duo™ chair comes with a pressure moulded veneer shell and is available in two different finishes: Clear lacquered (oak or walnut) or black coloured ash (195) veneer. The shell is also available in front or fully upholstered versions in a wide range of textiles and leather types. Besides a four-legged tubular steel base, the Vico Duo™ is configurable with a sledge base made of solid steel, or as counter or bar stool with a four-legged tubular steel base. The chair is also available with a seat cushion in textile, mounted or purchased separately. Armrests are available on the models detailed below.

MODEL	DESCRIPTION	BLACK COLOURED ASH	CLEAR LACQUERED VENEER
VM110	Chair, stackable (max 10 pcs.), seat height 46 cm, 4 legs, chromed or black powder coated tubular steel base	288	288
VM111	Armchair, stackable (max 8 pcs.), seat height 46 cm, 4 legs, chromed or black powder coated tubular steel base	354	354
VM112	Chair w/welded linking device, stackable (max 8 pcs.), seat height 46 cm, 4 legs, chromed or black powder coated tubular steel base	387	387
VM113	Armchair w/welded linking device, stackable (max 8 pcs.), seat height 46 cm, 4 legs, chromed or black powder coated tubular steel base	478	478
VM114	Chair, stackable (max 8 pcs.), seat height 46 cm, chromed steel sledge base	288	288
VM115	Chair w/welded linking device, stackable (max 8 pcs.), seat height 46 cm, chromed steel sledge base	346	346
VM116	Counter stool, stackable (max 4 pcs.), seat height 64 cm, chromed or black powder coated tubular steel base	362	362
VM118	Bar stool, stackable (max 4 pcs.), seat height 76 cm, chromed or black powder coated tubular steel base	428	428

CLEAR LACQUERED VENEER: - SEE THE SURFACE SELECTION  
OAK, WALNUT

**FRONT UPHOLSTERED - BLACK COLOURED ASH**

MODEL	DESCRIPTION	CHRISTIANSHAVN	CATEGORY 1	CATEGORY 2	CATEGORY 3	CATEGORY 4	CATEGORY 5
VM110	Chair, seat height 46 cm, 4 legs with arms, chromed or black powder coated tubular steel base	379	412	470	552	660	825
VM111	Armchair, seat height 46 cm, 4 legs, chromed or black powder coated tubular steel base	437	478	528	610	718	908
VM112	Chair w/welded linking device, seat height 46 cm, 4 legs, chromed or black powder coated tubular steel base	478	511	561	652	759	949
VM113	Armchair w/welded linking device, seat height 46 cm, 4 legs, chromed or black powder coated tubular steel base	561	594	652	734	866	1.032
VM114	Chair, seat height 46 cm, chromed steel sledge base	379	412	470	552	660	825
VM115	Chair w/welded linking device, seat height 46 cm, chromed steel sledge base	428	470	519	610	709	908
VM116	Counter stool, seat height 64 cm, chromed or black powder coated tubular steel base	445	486	536	627	726	908
VM118	Bar stool, seat height 76 cm, chromed or black powder coated tubular steel base	519	552	610	693	800	990

**FRONT UPHOLSTERED - CLEAR LACQUERED VENEER**

MODEL	DESCRIPTION	CHRISTIANSHAVN	CATEGORY 1	CATEGORY 2	CATEGORY 3	CATEGORY 4	CATEGORY 5
VM110	Chair, seat height 46 cm, 4 legs with arms, chromed or black powder coated tubular steel base	379	412	470	552	660	825
VM111	Armchair, seat height 46 cm, 4 legs, chromed or black powder coated tubular steel base	437	478	528	610	718	908
VM112	Chair w/welded linking device, seat height 46 cm, 4 legs, chromed or black powder coated tubular steel base	478	511	561	652	759	949
VM113	Armchair w/welded linking device, seat height 46 cm, 4 legs, chromed or black powder coated tubular steel base	561	594	652	734	866	1.032
VM114	Chair, seat height 46 cm, chromed steel sledge base	379	412	470	552	660	825
VM115	Chair w/welded linking device, seat height 46 cm, chromed steel sledge base	428	470	519	610	709	908
VM116	Counter stool, seat height 64 cm, chromed or black powder coated tubular steel base	445	486	536	627	726	908
VM118	Bar stool, seat height 76 cm, chromed or black powder coated tubular steel base	519	552	610	693	800	990

CATEGORY 1: BELFAST, CANVAS, CAPTURE, DIABLO, FAME, REMIX, TONUS  
 CATEGORY 2: DIVINA, DIVINA MELANGE, DIVINA MD, FIORD, HALLINGDAL, RE-WOOL, STEELCUT, STEELCUT TRIO, SUNNIVA  
 CATEGORY 3: ESSENTIAL  
 CATEGORY 4: SOFT  
 CATEGORY 5: GRACE, EMBRACE, NATURAL

SELECTED TEXTILE COLOURS - SEE THE SURFACE SELECTION  
 BELFAST (770593, 770660, 771772, 772062, 772143, 772150, 772255, 774232, 774926, 775139)



FULLY UPHOLSTERED

MODEL	DESCRIPTION	CHRISTIANSHAVN	CATEGORY 1	CATEGORY 2	CATEGORY 3	CATEGORY 4	CATEGORY 5
VM110	Chair, seat height 46 cm, 4 legs with arms, chromed or black powder coated tubular steel base	428	461	511	652	825	1.156
VM111	Armchair, seat height 46 cm, 4 legs, chromed or black powder coated tubular steel base	486	519	569	709	908	1.197
VM112	Chair w/welded linking device, seat height 46 cm, 4 legs, chromed or black powder coated tubular steel base	519	552	610	742	949	1.238
VM113	Armchair w/welded linking device, seat height 46 cm, 4 legs, chromed or black powder coated tubular steel base	610	643	693	825	1.032	1.321
VM114	Chair, seat height 46 cm, chromed steel sledge base	428	461	511	652	825	1.156
VM115	Chair w/welded linking device, seat height 46 cm, chromed steel sledge base	478	511	561	701	908	1.197
VM116	Counter stool, seat height 64 cm, chromed or black powder coated tubular steel base	495	528	577	718	908	1.238
VM118	Bar stool, seat height 76 cm, chromed or black powder coated tubular steel base	561	594	652	792	990	1.280

CATEGORY 1: BELFAST, CANVAS, CAPTURE, DIABLO, FAME, REMIX, TONUS  
 CATEGORY 2: DIVINA, DIVINA MELANGE, DIVINA MD, FIORD, HALLINGDAL, RE-WOOL, STEELCUT, STEELCUT TRIO, SUNNIVA  
 CATEGORY 3: ESSENTIAL  
 CATEGORY 4: SOFT  
 CATEGORY 5: GRACE, EMBRACE, NATURAL

SELECTED TEXTILE COLOURS - SEE THE SURFACE SELECTION  
 BELFAST (770593, 770660, 771772, 772062, 772143, 772150, 772255, 774232, 774926, 775139)

OPTIONS

DESCRIPTION	PRICE
Small transport dolly for 10 pcs. Vico Duo chairs without arms (except counter and bar stool) and 8 pcs. with arms, non-upholstered	395
Linking device for VM114	32
Felt glides (4 pcs.)	7
VM170 seat cushion, Just textile black (60999) or dark grey (60121)	57

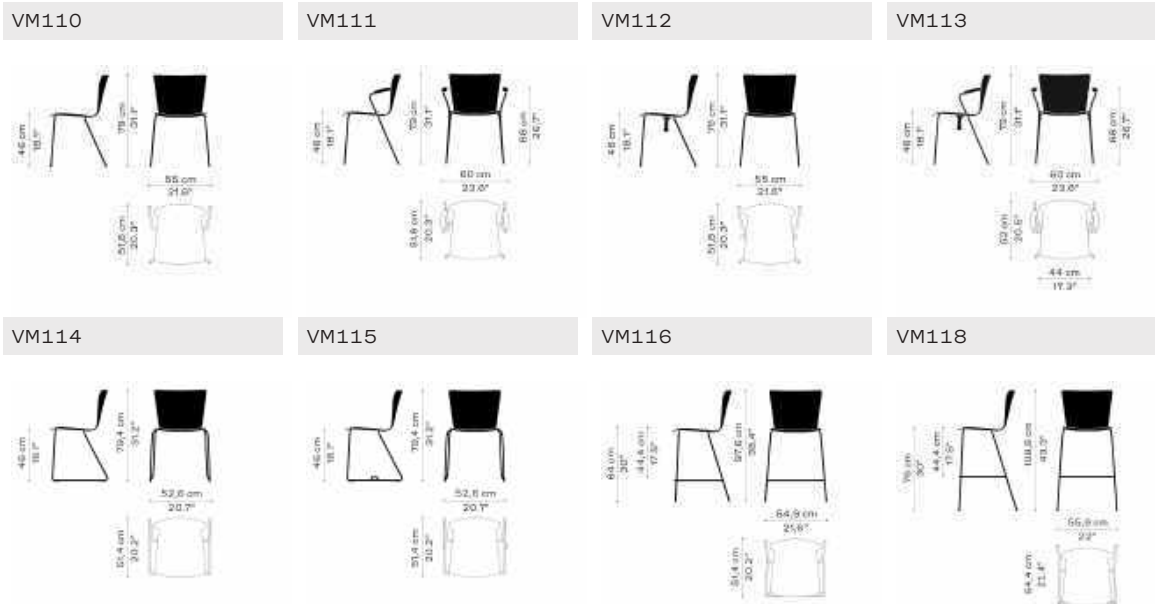

SMALL TRANSPORT DOLLY





**CHINA CHAIR™**  
**HANS J. WEGNER 1944**

**01.2025**

The China Chair™ is available in two types of solid wood: Clear lacquered cherry and black coloured ash. The chair comes with an integrated loose seat cushion, upholstered in leather and available in various leather types.

MODEL	DESCRIPTION	CATEGORY 4	CATEGORY 5
4283	Armchair, seat height 45 cm, solid wood, clear lacquered cherry	7.850	8.180
4283	Armchair, seat height 45 cm, solid wood, black coloured ash	6.280	6.610
4283SC	Replacement seat cushion (loose)	1.073	1.404

CATEGORY 4: AURA  
CATEGORY 5: GRACE, EMBRACE, NATURAL

4283

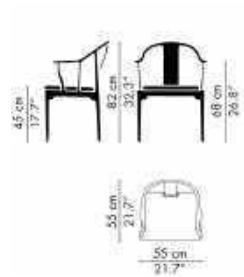



## CARIMATE™ VICO MAGISTRETTI 1959

01.2025

Originally designed in 1959 for the Carimate golf club north of Milan, from which the chair takes its name, Vico Magistretti's bold and charismatic design became a highly prized collectable piece from the Italian designer's body of work. A strikingly memorable as well as comfortable chair, the Carimate™ is known for its bold personality and finely detailed construction. Magistretti's charismatic Carimate is available in untreated Beech and black coloured Ash with paper cord seat as a pure and honest expression of the design icon. Perfect for creating a bold and memorable dining setting and a must-have for collectors of Magistretti works.

MODEL	DESCRIPTION	UNTREATED BEECH	BLACK COLOURED ASH
VM120	Armchair, seat height 45 cm	1.114	1.156

### VM120

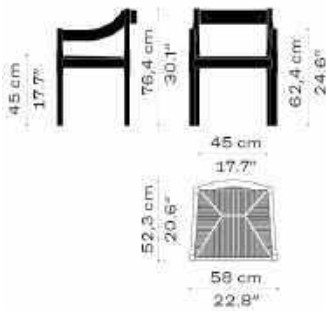



**MONOLIT™**  
**CECILIE MANZ 2024**

The Monolit™ by Cecilie Manz is a contemporary, distinct chair design made to elevate dining and lounge environments with its graceful elegance and tranquil expression. Available in two heights ideal for dining and lounging, its signature cocooning shape offers a welcoming embrace, providing both comfort and a sense of privacy, while the innovative design includes a space underneath for securely storing personal items.

MODEL	DESCRIPTION	CHRISTIANSHAVN	CATEGORY 1	CATEGORY 2	CATEGORY 3	CATEGORY 5
CM220	Dining chair, seat height 44 cm, textile piping	1.156	1.321	1.569		
CM221	Dining chair, seat height 44 cm, hand stitched leather piping	1.404	1.569	1.817	-	2.230

CATEGORY 1: TONUS  
 CATEGORY 2: HALLINGDAL, SERPENTINE, SUNNIVA, TWILL WEAVE, VIDAR  
 CATEGORY 5: NATURAL

**GM220 / CM221**

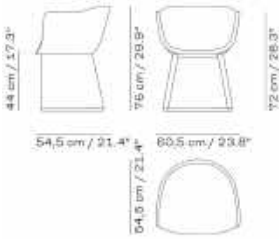





# TABURET CECILIE MANZ 2021

01.2025

Taburet is a contemporary, functional stool and occasional side table design that embodies uncompromising precision in its exquisite craftsmanship. Offering tactility and sitting comfort, Taburet is crafted in oiled solid wood with visible grain and a subtly concaved seat.

MODEL	DESCRIPTION	OILED PINE	OILED CHERRY
CM210	Stool, seat height 46 cm	1.445	1.734

## CM210

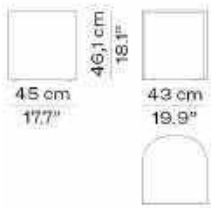



## UTZON STOOL JØRN UTZON 1950

01.2025

The Utzon Stool is a captivating creative expression by acclaimed Danish architect Jørn Utzon. It was designed during the same period as the Sydney Opera House. The stool is a meticulously crafted functional sculpture. Decorative in appearance yet deceptively comfortable.

Crafted with oiled solid beech wood, veneer beech wood, and adorned with beautiful brass detailing. The stool exudes an extrovert playfulness in its fascinating appearance.

MODEL	DESCRIPTION	CLEAR LACQUERED BEECH
JU01	Stool, seat height 43 cm	949

JU01

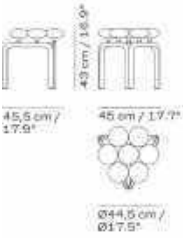



**SERIES 3300™**  
**ARNE JACOBSEN 1956**

**01.2025**

Series 3300™ is available both as a lounge chair and a 2- or 3-seater sofa. Its frame is made of chromed tubular steel, while the cushions are made of cut HR foam covering a wooden base structure. The cushions come fully upholstered in a wide range of textiles and leather types.

MODEL	DESCRIPTION	CHRISTIANSHAVN	CATEGORY 1	CATEGORY 2	CATEGORY 3	CATEGORY 4	CATEGORY 5
3300	Lounge chair, chromed tubular steel base	4.131	4.379	4.627	6.528	8.098	9.503

CATEGORY 1: CANVAS, CAPTURE, DIABLO, FAME, REMIX, TONUS  
 CATEGORY 2: DIVINA, DIVINA MELANGE, DIVINA MD, FIORD, HALLINGDAL, RE-WOOL, STEELCUT, STEELCUT TRIO, SUNNIVA  
 CATEGORY 3: ESSENTIAL  
 CATEGORY 4: AURA  
 CATEGORY 5: GRACE, EMBRACE, NATURAL

**3300**

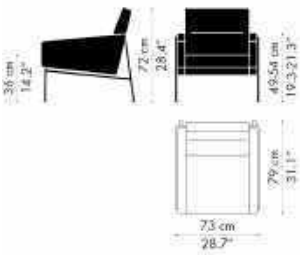



The Egg™ lounge chair comes fully upholstered in a wide range of textiles and leather types. The four-star base consists either of a satin chromed steel column connected to a base in satin brushed aluminium or a powder coated steel column connected to a base in powder coated aluminium. The inner shell is made of a hard moulded foam, padded with a softer foam structure to increase comfort. A matching Egg™ footstool is available in the same base and upholstery options as the Egg™ lounge chair.

MODEL	DESCRIPTION	CHRISTIANSHAVN	CATEGORY 1	CATEGORY 2	CATEGORY 3	CATEGORY 4	CATEGORY 5
3316	Lounge chair, 4-star base, tilt and swivel	6.032	6.362	6.776	8.676	9.503	10.329
3127	Footstool, 4-star base	1.900	1.941	1.982	2.147	2.395	2.726

CATEGORY 1: CANVAS, CAPTURE, DIABLO, FAME, TONUS  
 CATEGORY 2: DIVINA, DIVINA MELANGE, DIVINA MD, FIORD, HALLINGDAL, RE-WOOL, STEELCUT, STEELCUT TRIO, SUNNIVA  
 CATEGORY 3: ESSENTIAL  
 CATEGORY 4: AURA  
 CATEGORY 5: GRACE, EMBRACE, NATURAL

BASE COLOURS  
 SILVER GREY, WARM GRAPHITE, BROWN BRONZE, BLACK, BRUSHED ALUMINIUM

**OPTIONS**

DESCRIPTION	PRICE
Automatic return for 3316	164

3316

3127





The Swan™ lounge chair comes fully upholstered in a wide range of textiles and leather types. The four-star base consists either of a satin chromed steel column connected to a base in satin brushed aluminium or a powder coated steel column connected to a base in powder coated aluminium. The inner shell is made of a hard moulded foam, padded with a softer foam structure to increase comfort.

MODEL	DESCRIPTION	CHRISTIANSHAVN	CATEGORY 1	CATEGORY 2	CATEGORY 3	CATEGORY 4	CATEGORY 5
3320	Lounge chair, 4-star base, swivel	3.470	3.635	3.800	4.627	5.205	5.784

CATEGORY 1: CAPTURE, DIABLO, FAME, TONUS  
 CATEGORY 2: DIVINA, DIVINA MELANGE, DIVINA MD, FIORD, HALLINGDAL, RE-WOOL, STEELCUT, STEELCUT TRIO, SUNNIVA  
 CATEGORY 3: ESSENTIAL  
 CATEGORY 4: AURA  
 CATEGORY 5: GRACE, EMBRACE, NATURAL

BASE COLOURS  
 SILVER GREY, WARM GRAPHITE, BROWN BRONZE, BLACK, BRUSHED ALUMINIUM

DESCRIPTION	PRICE
Automatic return for 3320	164
Special seat height: 48 cm	44

3320

3320 + 8 CM

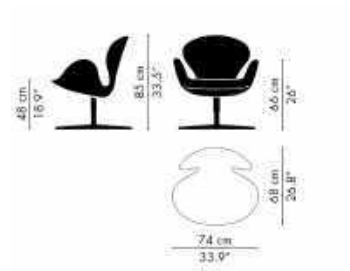



**OKSEN™**  
**ARNE JACOBSEN 1968/2017**

**01.2025**

Oksen™ lounge chair comes in three different leather types: Aura and Grace in the colours black and walnut as well as in Essential leather. The five-star base is available in black powder coated aluminium or satin brushed aluminium with a satin brushed steel column. A matching Oksen™ footstool is available in the same base and upholstery options as the Oksen™ lounge chair.

MODEL	DESCRIPTION	CATEGORY 3	CATEGORY 4	CATEGORY 5
4201	Lounge chair, swivel, satin brushed aluminium or black powder coated aluminium	9.090	11.156	12.809
4210	Footstool, satin brushed aluminium or black powder coated aluminium	2.230	2.726	2.974

CATEGORY 3: ESSENTIAL  
 CATEGORY 4: AURA (Black or Walnut)  
 CATEGORY 5: GRACE (Black or Walnut)

**OPTIONS**

DESCRIPTION	PRICE
Automatic return for 4201	164

4201

4210





**POT™**  
**ARNE JACOBSEN 1959/2017**

**01.2025**

The Pot™ lounge chair comes fully upholstered in a wide range of textiles and leather types. The inner shell is made of a hard moulded foam, padded with a softer foam structure to increase comfort. The lounge chair's base consists of four legs in chromed or Brown Bronze powder coated tubular steel.

MODEL	DESCRIPTION	CHRISTIANSHAVN	CATEGORY 1	CATEGORY 2	CATEGORY 3	CATEGORY 4	CATEGORY 5
3318	Lounge chair, chromed or Brown Bronze powder coated tubular steel base	1.528	1.610	1.817	2.313	2.809	3.222

CATEGORY 1: CANVAS, CAPTURE, DIABLO, FAME, REMIX, TONUS  
 CATEGORY 2: DIVINA, DIVINA MELANGE, DIVINA MD, FIORD, HALLINGDAL, RE-WOOL, STEELCUT, STEELCUT TRIO, SUNNIVA  
 CATEGORY 3: ESSENTIAL  
 CATEGORY 4: AURA  
 CATEGORY 5: GRACE, EMBRACE, NATURAL

**3318**





The Lissoni Sofa™ is a fully upholstered sofa series and comes in a variety of sizes and corner configurations. The sofa cushions consist of a core of cut foam and a channel sewed comfort-enhancing cover stuffed with synthetic flakes and feathers. The frame is either made of matt brushed stainless steel or powder coated steel. The Lissoni Sofa™ is available in a wide range of textiles and leather types.

**MATT BRUSHED STAINLESS STEEL FRAME**

MODEL	DESCRIPTION	CHRISTIANSHAVN	CATEGORY 1	CATEGORY 2	CATEGORY 3	CATEGORY 4	CATEGORY 5
PL111S	Lounge chair	3.222	3.387	3.718	4.379	4.875	6.280
PL111	Lounge chair	3.718	4.131	4.214	4.875	5.619	7.189

**POWDER COATED STEEL FRAME**

MODEL	DESCRIPTION	CHRISTIANSHAVN	CATEGORY 1	CATEGORY 2	CATEGORY 3	CATEGORY 4	CATEGORY 5
PL111S	Lounge chair	2.643	2.809	3.057	3.635	3.966	5.123
PL111	Lounge chair	3.057	3.387	3.470	3.966	4.627	5.866

CATEGORY 1: CANVAS, CAPTURE, DIABLO, FAME, REMIX, TONUS  
 CATEGORY 2: CLAY, DIVINA, DIVINA MELANGE, DIVINA MD, FIORD, HALLINGDAL, MOSS, RE-WOOL, STEELCUT, STEELCUT TRIO, SUNNIVA  
 CATEGORY 3: ESSENTIAL  
 CATEGORY 4: SOFT  
 CATEGORY 5: GRACE, EMBRACE, NATURAL

BASE COLOURS  
 BROWN BRONZE, BLACK, MATT BRUSHED STAINLESS STEEL

**PL111S**

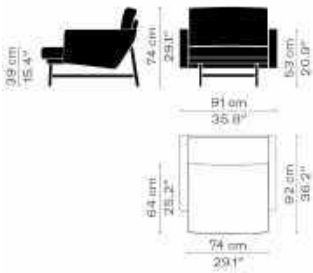

**PL111**

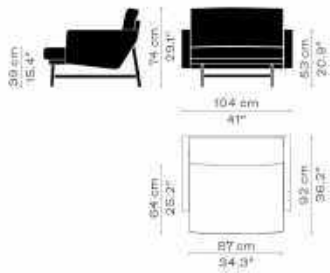





The Ro™ lounge chair comes fully upholstered in a wide range of textiles. Single textile or a mix of two textiles; one textile for the shell and one for the cushions. The base is available with four legs in brushed aluminium or solid oak with a clear lacquer finish. A matching Ro™ footstool is available in the same base and upholstery options as the Ro™ lounge chair.

MODEL	DESCRIPTION	CHRISTIANSHAVN	CATEGORY 1	CATEGORY 2
JH1	Lounge chair, brushed aluminium legs	2.726	2.809	2.809
JH2	Lounge chair, solid oak legs	2.726	2.809	2.809
JH11	Footstool, brushed aluminium legs	792	825	825
JH12	Footstool, solid oak legs	792	825	825

CATEGORY 1: CANVAS (ONLY CUSHIONS & FOOTSTOOL), CAPTURE, DIABLO (ONLY CUSHIONS & FOOTSTOOL), FAME, REMIX (ONLY CUSHIONS & FOOTSTOOL), TONUS  
 CATEGORY 2: DIVINA, DIVINA MD, DIVINA MELANGE, FIORD, HALLINGDAL, RE-WOOL, STEELCUT, STEELCUT TRIO, SUNNIVA, TWILL WEAVE, VIDAR

JH1

JH2

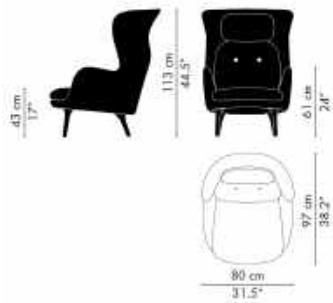

JH11

JH12

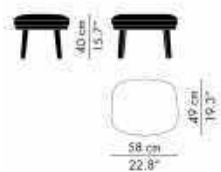
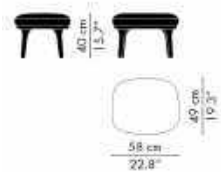



Fri™ is offered as a lounge chair, sofa, and footstool, and is fully upholstered in a diverse selection of textiles. Choose between tapered legs in aluminium or solid oak, and opt for a single textile or a combination of two textiles.

MODEL	DESCRIPTION	CHRISTIANSHAVN	CATEGORY 1	CATEGORY 2
JH4	Lounge chair, brushed aluminium legs	2.478	2.561	2.561
JH5	Lounge chair, solid oak legs	2.478	2.561	2.561
JH14	Footstool, brushed aluminium legs	792	825	825
JH15	Footstool, solid oak legs	792	825	825

CATEGORY 1: CANVAS, CAPTURE, FAME, REMIX, TONUS  
CATEGORY 2: DIVINA, DIVINA MD, DIVINA MELANGE, FIORD, HALLINGDAL, RE-WOOL, STEELCUT, STEELCUT TRIO, SUNNIVA, VIDAR

JH4

JH5

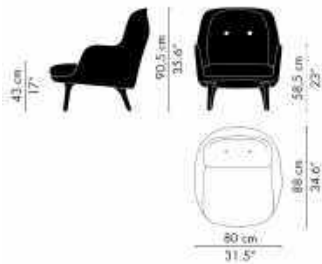

JH14

JH15





VIA57™  
BJARKE INGELS IN COLLABORATION WITH KIBISI 2016

01.2025

VIA57™ lounge chair comes fully upholstered in a range of textiles. The wooden base is made of solid oak with a clear lacquer finish. Seat and back are composed of soft moulded PE foam around an inner steel frame.

MODEL	DESCRIPTION	CHRISTIANSHAVN	CATEGORY 1	CATEGORY 2
BIO1	Lounge chair, solid oak base	2.147	2.147	2.313

CATEGORY 1: CAPTURE, TONUS  
CATEGORY 2: DIVINA, DIVINA MD, DIVINA MELANGE, FIORD, HALLINGDAL, RE-WOOL, STEELCUT, STEELCUT TRIO, SUNNIVA

BIO1





**FRED™**  
**JAIME HAYON 2019**

The Fred™ lounge chair is available in two types of solid wood and a total of four different finishes: Black coloured ash, clear lacquered (oak or walnut stained oak) or oiled oak. The upholstered cushions are available in a variety of textile and leather types.

MODEL	DESCRIPTION	CHRISTIANSHAVN	CATEGORY 1	CATEGORY 2	CATEGORY 3
JH97	Lounge chair, Black coloured oak	1.900	1.982	2.065	2.395
JH97	Lounge chair, Walnut stained oak	1.900	1.982	2.065	2.395
JH97	Lounge chair, Clear lacquered oak	1.982	2.065	2.147	2.478
JH97	Lounge chair, Natural oiled oak	1.982	2.065	2.147	2.478

CATEGORY 1: BELFAST  
 CATEGORY 2: HALLINGDAL, RE-WOOL  
 CATEGORY 3: ESSENTIAL

SELECTED TEXTILE COLOURS - SEE THE SURFACE SELECTION  
 BELFAST (770593, 770660, 771772, 772062, 772143, 772150, 772255, 774232, 774926, 775139)

JH97





**LET™**  
**SEBASTIAN HERKNER 2020**

**01.2025**

The Let™ lounge chair comes fully upholstered and is available in a wide range of textiles and leather. Inner seat and backrest of the chair are made from PUR-foam moulded around an inner steel frame. The four-legged base of the Let™ lounge chair is available either in solid wood or tubular steel. The wooden bases come with a clear lacquered oak, clear lacquered ash or black coloured ash finish, while steel bases are available in chrome or powder coated in Black, Warm Graphite or Brown Bronze.

MODEL	DESCRIPTION	CHRISTIANSHAVN	CATEGORY 1	CATEGORY 2	CATEGORY 3
SH200	Lounge chair, wooden base	1.569	1.652	1.734	1.900
SH210	Lounge chair, chromed or powder coated tubular steel base	1.486	1.569	1.652	1.817

CATEGORY 1: CANVAS, REMIX, FAME, TONUS

CATEGORY 2: DIVINA, DIVINA MELANGE, DIVINA MD, FIORD, HALLINGDAL, RE-WOOL, STEELCUT, STEELCUT TRIO, SUNNIVA, VANIR

CATEGORY 3: ESSENTIAL

BASE COLOURS

SH200: CLEAR LACQUERED OAK, CLEAR LACQUERED ASH OR BLACK COLOURED ASH

SH210: BROWN BRONZE, BLACK, CHROME

SH200

SH210





**MONOLIT™**  
**CECILIE MANZ 2024**

The Monolit™ by Cecilie Manz is a contemporary, distinct chair design made to elevate dining and lounge environments with its graceful elegance and tranquil expression. Available in two heights ideal for dining and lounging, its signature cocooning shape offers a welcoming embrace, providing both comfort and a sense of privacy, while the innovative design includes a space underneath for securely storing personal items.

DESCRIPTION	CHRISTIANSHAVN	CATEGORY 1	CATEGORY 2	CATEGORY 3	CATEGORY 5
CM230 Lounge chair, seat height 39 cm, textile piping	1.156	1.321	1.569	-	-
CM231 Lounge chair, seat height 39 cm, hand stitched leather piping	1.404	1.569	1.817	-	2.230

CATEGORY 1: TONUS  
 CATEGORY 2: HALLINGDAL, SERPENTINE, SUNNIVA, TWILL WEAVE, VIDAR  
 CATEGORY 5: NATURAL

**CM230 / CM231**





**SERIES 3300™**  
**ARNE JACOBSEN 1956**

01.2025

Series 3300™ is available both as a lounge chair and a 2- or 3-seater sofa. Its frame is made of chromed tubular steel, while the cushions are made of cut HR foam covering a wooden base structure. The cushions come fully upholstered in a wide range of textiles and leather types.

MODEL	DESCRIPTION	CHRISTIANSHAVN	CATEGORY 1	CATEGORY 2	CATEGORY 3	CATEGORY 4	CATEGORY 5
3302	2-seater sofa, chromed tubular steel base	6.114	6.445	6.776	9.916	11.569	13.635
3303	3-seater sofa, chromed tubular steel base	8.098	8.676	9.090	12.809	15.288	17.767
	Additional modules for Series 3300, chromed tubular steel base	1.982	2.147	2.230	3.222	3.552	4.131

CATEGORY 1: CANVAS, CAPTURE, DIABLO, FAME, REMIX, TONUS  
 CATEGORY 2: DIVINA, DIVINA MELANGE, DIVINA MD, FIORD, HALLINGDAL, RE-WOOL, STEELCUT, STEELCUT TRIO, SUNNIVA  
 CATEGORY 3: ESSENTIAL  
 CATEGORY 4: AURA  
 CATEGORY 5: GRACE, EMBRACE, NATURAL

**3302**

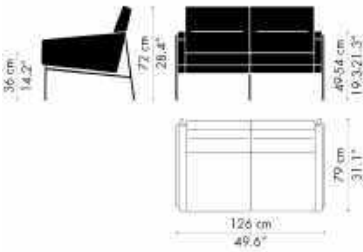

**3303**

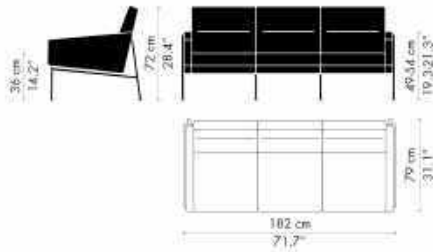



**SWAN SOFA™**  
**ARNE JACOBSEN 1958**

**01.2025**

The Swan™ sofa comes fully upholstered in a wide range of textiles and leather types. The sofa rests on a shaker base in satin brushed aluminium. The inner shell is made of a hard moulded foam, padded with a comfort-enhancing foam structure with lower density.

MODEL	DESCRIPTION	CHRISTIANSHAVN	CATEGORY 1	CATEGORY 2	CATEGORY 3	CATEGORY 4	CATEGORY 5
3321	2-seater sofa, shaker base, satin brushed aluminium	7.354	7.685	8.180	10.742	12.395	14.048

CATEGORY 1: CAPTURE, DIABLO, FAME, TONUS  
 CATEGORY 2: DIVINA, DIVINA MELANGE, DIVINA MD, FIORD, HALLINGDAL, RE-WOOL, STEELCUT, STEELCUT TRIO, SUNNIVA  
 CATEGORY 3: ESSENTIAL  
 CATEGORY 4: AURA  
 CATEGORY 5: GRACE, EMBRACE, NATURAL

**3321**

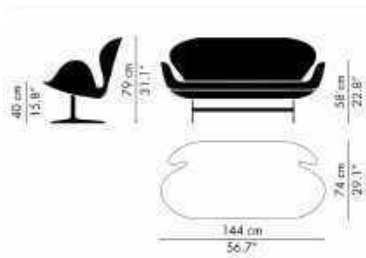





The Lissoni Sofa™ is a fully upholstered sofa and comes in a variety of sizes and corner configurations. The sofa cushions consist of a core of cut foam and a channel sewed comfort-enhancing cover stuffed with synthetic flakes and feathers. The frame is either made of matt brushed stainless steel or powder coated steel. The Lissoni Sofa™ is available in a wide range of textiles and leather types.

**MATT BRUSHED STAINLESS STEEL FRAME**

MODEL	DESCRIPTION	CHRISTIANSHAVN	CATEGORY 1	CATEGORY 2	CATEGORY 3	CATEGORY 4	CATEGORY 5
PL110S	Pouf	1.404	1.528	1.734	1.982	2.230	2.809
PL110	Pouf	1.610	1.734	1.900	2.230	2.478	3.139
PL112S	2-seater sofa, length 168 cm	4.957	5.205	6.032	6.858	7.602	9.916
PL112	2-seater sofa, length 198 cm	6.197	6.528	7.519	8.676	9.503	12.395
PL113S	3-seater sofa, length 243 cm	7.354	7.767	9.090	10.329	11.156	14.875
PL113	3-seater sofa, length 288 cm	9.090	9.503	10.329	11.982	13.222	16.941
PL114S	4-seater corner sofa, left / right	9.916	10.329	11.569	13.635	14.875	19.420
PL114	4-seater corner sofa, left / right	10.742	11.156	12.809	14.875	16.114	21.486
PL115S	5-seater corner sofa	11.569	11.982	13.635	15.701	17.354	22.313
PL115	5-seater corner sofa	12.809	13.635	15.288	17.354	19.420	25.205
PL116S	5-seater corner sofa, left / right	12.809	13.635	14.875	17.354	19.007	24.792
PL116	5-seater corner sofa, left / right	14.461	15.288	16.114	18.594	21.073	26.858
PL117S	6-seater corner sofa, left / right	13.635	14.461	16.528	19.007	20.660	26.858
PL117	6-seater corner sofa, left / right	15.288	16.114	18.594	20.660	23.139	30.164
PL118S	7-seater corner sofa	16.114	16.941	19.420	21.900	24.379	31.404
PL118	7-seater corner sofa	17.354	19.420	20.660	24.379	27.685	34.709

**POWDER COATED STEEL FRAME**

MODEL	DESCRIPTION	CHRISTIANSHAVN	CATEGORY 1	CATEGORY 2	CATEGORY 3	CATEGORY 4	CATEGORY 5
PL110S	Pouf	1.156	1.238	1.404	1.610	1.817	2.313
PL110	Pouf	1.321	1.404	1.569	1.817	1.982	2.561
PL112S	2-seater sofa, length 168 cm	4.131	4.379	4.957	5.701	6.280	8.180
PL112	2-seater sofa, length 198 cm	5.288	5.536	6.362	7.271	8.015	10.329
PL113S	3-seater sofa, length 243 cm	6.362	6.776	7.685	9.090	9.916	12.809
PL113	3-seater sofa, length 288 cm	7.850	8.263	9.503	10.742	11.982	15.701
PL114S	4-seater corner sofa, left / right	8.676	9.090	9.916	11.569	12.809	16.528
PL114	4-seater corner sofa, left / right	9.916	10.742	11.569	13.635	15.288	19.420
PL115S	5-seater corner sofa	9.916	10.329	11.569	13.635	14.875	19.420
PL115	5-seater corner sofa	11.982	12.809	14.461	16.528	18.180	23.552
PL116S	5-seater corner sofa, left / right	10.742	11.156	12.809	14.461	16.114	20.660
PL116	5-seater corner sofa, left / right	12.395	13.222	14.461	16.941	19.007	24.379
PL117S	6-seater corner sofa, left / right	11.982	12.809	14.461	16.528	18.180	23.552
PL117	6-seater corner sofa, left / right	14.461	15.288	17.354	19.833	21.900	28.511
PL118S	7-seater corner sofa	14.048	14.875	16.941	19.420	21.486	27.685
PL118	7-seater corner sofa	16.941	17.767	20.247	23.139	25.619	33.057

CATEGORY 1: CANVAS, CAPTURE, DIABLO, FAME, REMIX, TONUS  
 CATEGORY 2: CLAY, DIVINA, DIVINA MELANGE, DIVINA MD, FIORD, HALLINGDAL, MOSS, RE-WOOL, STEELCUT, STEELCUT TRIO, SUNNIVA  
 CATEGORY 3: ESSENTIAL  
 CATEGORY 4: SOFT  
 CATEGORY 5: GRACE, EMBRACE, NATURAL

BASE COLOURS  
 BROWN BRONZE, BLACK, MATT BRUSHED STAINLESS STEEL

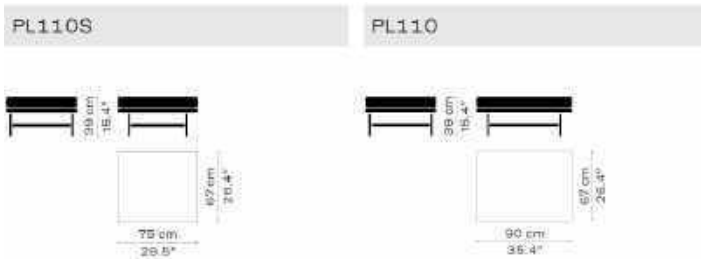



PL112S



PL112



PL113S



PL113

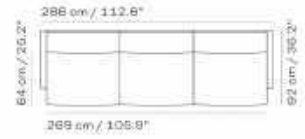

PL114S L

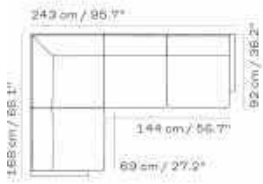

PL114S R

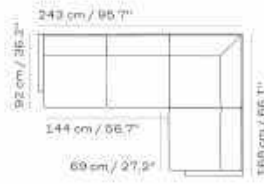

PL114 L

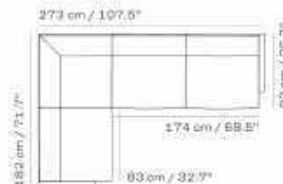

PL114 R



PL115S

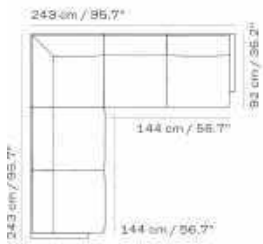

PL115



PL116S L

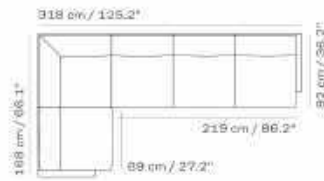

PL116S R

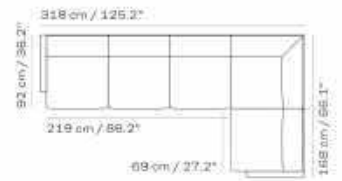

PL116 L

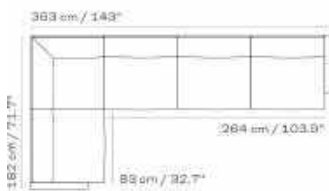

PL116 R



PL117S L

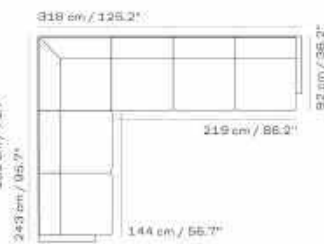

PL117S R

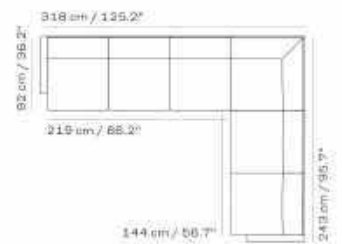

PL117 L

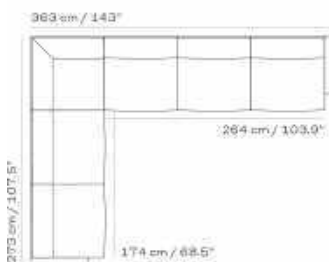

PL117 R

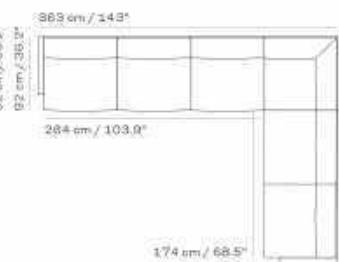

PL118S

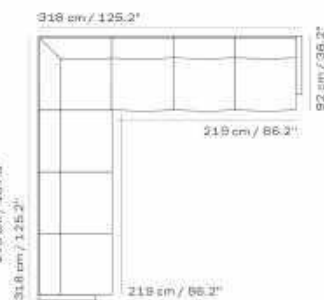

PL118

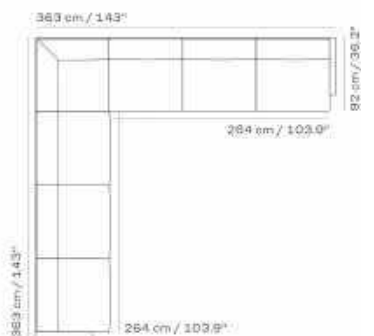



**ALPHABET™ SOFA SERIES**  
**PIERO LISSONI 2008**

**01.2025**

The Alphabet™ Sofa Series is a modular sofa system with units that can be combined in a variety of ways. The fully upholstered seat, back and armrest units come in a wide range of textiles, which can be removed for cleaning or replacement. You can choose to include a piping along the edges on both seat, back and armrests.

MODEL	DESCRIPTION	CHRISTIANSHAVN	CATEGORY 1	CATEGORY 2
PL210-1	2-seater sofa, 1 corner backrest, 1 backrest, 1 armrest	4.461	4.709	4.957
PL210-2	2-seater sofa, 1 corner backrest, 1 backrest, 1 armrest	4.461	4.709	4.957
PL210-3	2-seater sofa, 1 corner backrest, 1 backrest	3.966	4.131	4.379
PL210-4	2-seater sofa, 1 corner backrest, 1 backrest	3.966	4.131	4.379
PL240-1	2-seater sofa, 1 backrest, 2 armrests	4.544	4.792	5.040
PL240-2	2-seater sofa, 1 corner backrest, 1 backrest, 1 armrest	4.792	5.040	5.288
PL240-3	2-seater sofa, 1 corner backrest, 1 backrest, 1 armrest	4.792	5.040	5.288
PL240-4	2-seater sofa, 1 corner backrest, 1 backrest	4.131	4.379	4.627
PL240-5	2-seater sofa, 1 corner backrest, 1 backrest	4.131	4.379	4.627
PL255-1	3-seater sofa, 1 backrest, 2 armrests	5.288	5.619	5.866
PL270-1	3-seater sofa, 1 backrest, 2 armrests	5.453	5.784	6.032
PL300-1	3-seater sofa, 1 corner backrest, 2 backrests, 1 armrest	6.197	6.528	6.858
PL300-2	3-seater sofa, 1 corner backrest, 2 backrests, 1 armrest	6.197	6.528	6.858
PL300-3	4-seater sofa, 1 corner backrest, 2 backrests	7.023	7.437	7.850
PL300-4	4-seater sofa, 1 corner backrest, 2 backrests	7.023	7.437	7.850

MODEL	DESCRIPTION	CHRISTIANSHAVN	CATEGORY 1	CATEGORY 2
PL75-105	Sofa seat unit	1.032	1.073	1.156
PL90-105	Sofa seat unit	1.114	1.197	1.238
PL120-105	Sofa seat unit	1.280	1.321	1.404
PL120-120	Sofa seat unit	1.404	1.486	1.569

**BASE UNITS - BACK**

MODEL	DESCRIPTION	CHRISTIANSHAVN	CATEGORY 1	CATEGORY 2
PL75-30	Sofa back unit	544	569	594
PL90-30	Sofa back unit	594	627	660
PL120-30	Sofa back unit	660	693	734
PL150-30	Sofa back unit	792	825	908
PL180-30	Sofa back unit	908	949	990
PL240-30	Sofa back unit	1.032	1.073	1.156
PL255-30	Sofa back unit	1.114	1.156	1.238
PL270-30	Sofa back unit	1.156	1.238	1.280
PL90-90-30	Corner backrest	817	866	908

**BASE UNITS - ARMREST**

MODEL	DESCRIPTION	CHRISTIANSHAVN	CATEGORY 1	CATEGORY 2
PL60-30	Armrest	486	511	528

MODEL	DESCRIPTION	CHRISTIANSHAVN	CATEGORY 1	CATEGORY 2
PLO01	Additional sofa cushion (1 pcs.)	147	156	180

CATEGORY 1: CANVAS, CAPTURE, DIABLO, FAME, REMIX, TONUS  
CATEGORY 2: DIVINA, DIVINA MELANGE, DIVINA MD, FIORD, HALLINGDAL, KARAKORUM, RE-WOOL, STEELCUT, STEELCUT TRIO, SUNNIVA

ALPHABET COVERS ARE AVAILABLE FOR ALL MODULES AT 35% OF THE MODULE PRICE  
PIPING ALONG THE EDGES ON BOTH SEAT, BACK AND ARMRESTS IS AVAILABLE AT NO ADDITIONAL COST



PL210-1

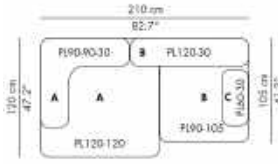

PL210-2

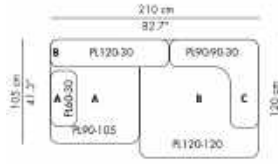

PL210-3

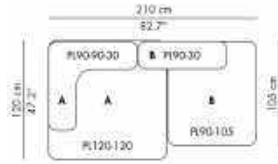

PL210-4

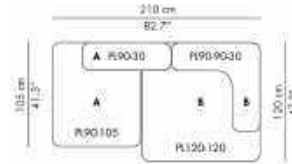

PL240-1

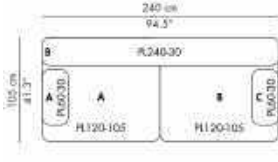

PL240-2

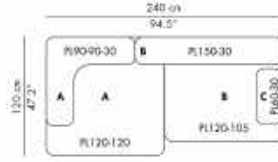

PL240-3



PL240-4

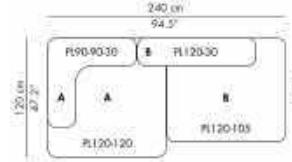

PL240-5

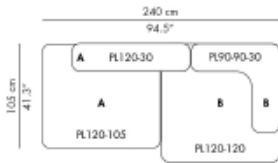

PL255-1

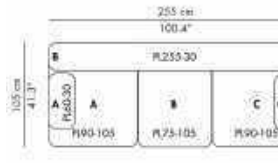

PL270-1

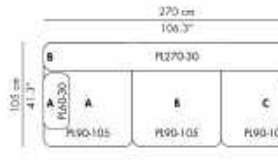

PL300-1

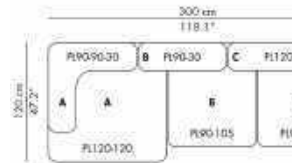

PL300-2

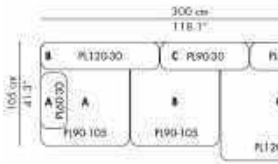

PL300-3

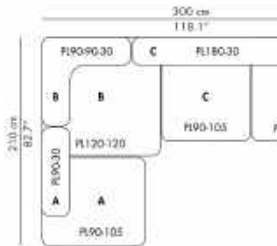

PL300-4

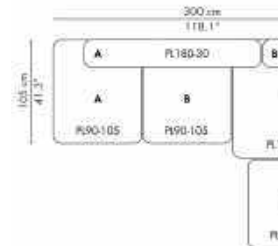

PL75-105

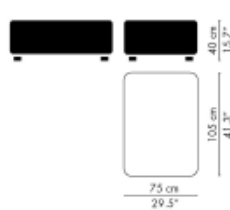

PL90-105

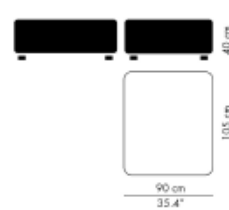

PL120-105

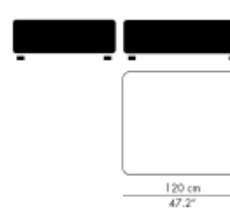

PL120-120

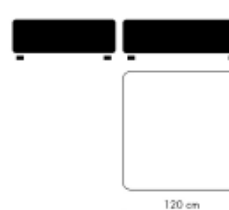

PL90-90-30

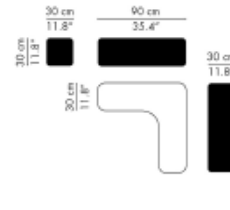

PL75-30

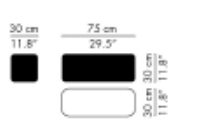

PL90-30



PL120-30



PL150-30



PL180-30



PL240-30

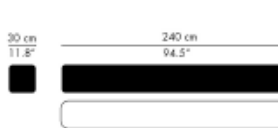

PL255-30

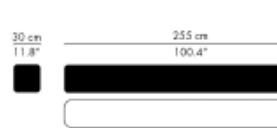

PL270-30

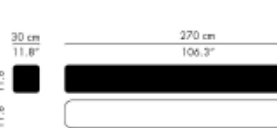

PL60-30

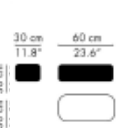

PL001

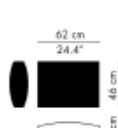



**FAVN™**  
**JAIME HAYON 2011**

**01.2025**

The Favn™ sofa comes in a wide range of textiles. It is available with a single coherent textile or a mix of up to three textiles; one textile for the shell and base, a second for the seat and back cushions and third textile for the small decorative cushions. The inner shell of the sofa is made of a hard moulded foam, padded with a soft, comfort-enhancing foam structure. The legs are made of brushed aluminium and a set of felt glides (for soft wooden floors) comes with the sofa as a standard.

MODEL	DESCRIPTION	CHRISTIANSHAVN	CATEGORY 1	CATEGORY 2
JH3	3-seater sofa, brushed aluminium legs incl. 2 loose decorative cushions	9.090	9.503	9.503

**OPTIONS**

MODEL	DESCRIPTION	CHRISTIANSHAVN	CATEGORY 1	CATEGORY 2
JH9	Additional decorative sofa cushion (1 pcs.)	238	263	263

CATEGORY 1: CANVAS (ONLY SEAT/BACK & DECORATIVE CUSHIONS), CAPTURE, DIABLO (ONLY SEAT/BACK & DECORATIVE CUSHIONS), FAME, REMIX (ONLY SEAT/BACK & DECORATIVE CUSHIONS), TONUS  
 CATEGORY 2: DIVINA, DIVINA MELANGE, DIVINA MD, FIORD, HALLINGDAL, RE-WOOL, STEELCUT, STEELCUT TRIO, SUNNIVA

JH3

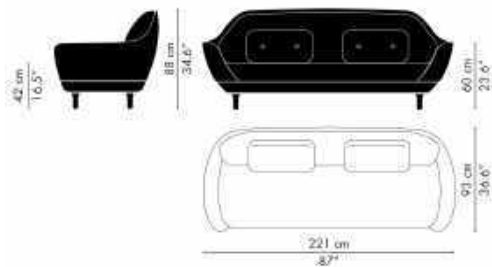

JH9

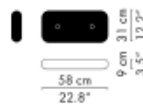



**LUNE™**  
JAIME HAYON 2017

01.2025

Lune™ is a modular sofa available in nine standard configurations featuring six different modules. The various modules can also be individually combined to create customised configurations. Lune™ comes fully upholstered in a variety of textiles and leather types. The base is available in brushed aluminium, or in two solid wood options: Clear lacquered oak or black coloured oak.

MODEL	DESCRIPTION	CHRISTIANSHAVN	CATEGORY 1	CATEGORY 2	CATEGORY 4	CATEGORY 5
JH200	Sofa, 2-seater, wooden or aluminium base	3.883	4.131	4.544	9.090	11.982
JH300	Sofa, 3-seater, wooden or aluminium base	5.453	5.701	6.362	11.982	16.528
JH301	Sofa, 3-seater with left chaise longue, wooden or aluminium base	6.280	6.610	7.354	12.809	18.180
JH302	Sofa, 3-seater with right chaise longue, wooden or aluminium base	6.280	6.610	7.354	12.809	18.180
JH400	Sofa, 4-seater, wooden or aluminium base	7.023	7.354	8.098	14.875	20.660
JH500	Sofa, 5-seater, wooden or aluminium base	8.676	9.090	9.916	17.767	25.205
JH510	Sofa, 5-seater with corner, wooden or aluminium base	10.329	10.742	11.569	20.247	29.751
JH600	Sofa, 6-seater, wooden or aluminium base	11.156	11.569	12.809	20.660	31.404
JH610	Sofa, 6-seater with corner, wooden or aluminium base	11.982	12.395	13.635	23.139	34.296

**SOFA MODULES**

MODEL	DESCRIPTION	CHRISTIANSHAVN	CATEGORY 1	CATEGORY 2	CATEGORY 4	CATEGORY 5
JH001	Sofa central module, wooden or aluminium base	1.817	1.900	2.065	3.470	4.957
JH002L	Sofa arm module left, wooden or aluminium base	2.065	2.147	2.395	4.214	5.949
JH002R	Sofa arm module right, wooden or aluminium base	2.065	2.147	2.395	4.214	5.949
JH003	Sofa corner module, wooden or aluminium base	2.809	2.891	3.139	5.205	7.437
JH004L	Sofa chaise longue module left, wooden or aluminium base	2.809	2.891	3.139	5.536	7.767
JH004R	Sofa chaise longue module right, wooden or aluminium base	2.809	2.891	3.139	5.536	7.767

CATEGORY 1: CANVAS, CAPTURE, DIABLO, FAME, LINARA, REMIX, TONUS  
 CATEGORY 2: DIVINA, DIVINA MELANGE, DIVINA MD, FIORD, HALLINGDAL, RE-WOOL, STEELCUT, STEELCUT TRIO, SUNNIVA  
 CATEGORY 4: AURA, SOFT  
 CATEGORY 5: EMBRACE

**BASE COLOURS**  
 BRUSHED ALUMINIUM, CLEAR LACQUERED OAK, BLACK COLOURED OAK

**SELECTED TEXTILE COLOURS - SEE THE SURFACE SELECTION**  
 LINARA (2494/198, 2494/324, 2494/118, 2494/340, 2494/30, 2494/237)



JH200

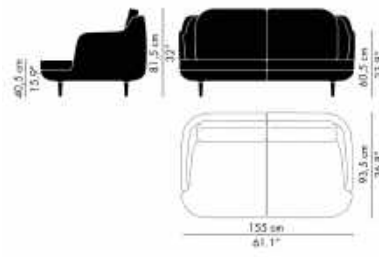

JH300

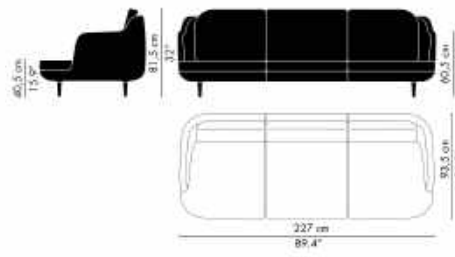

JH301

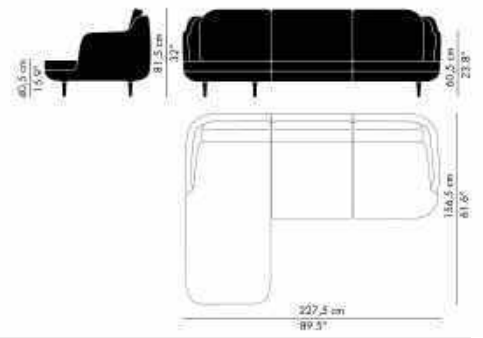

JH302

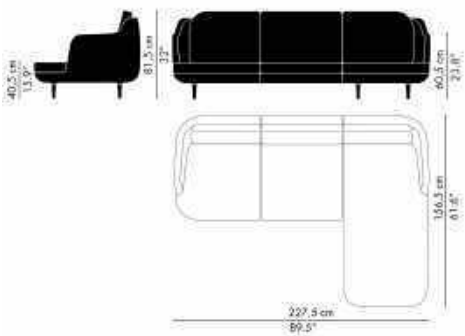

JH400

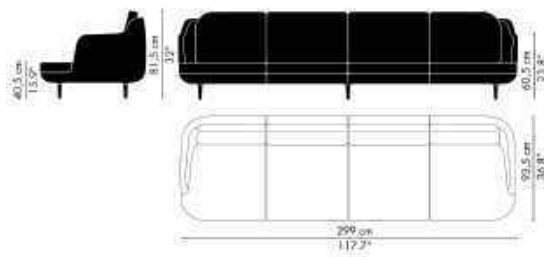

JH500

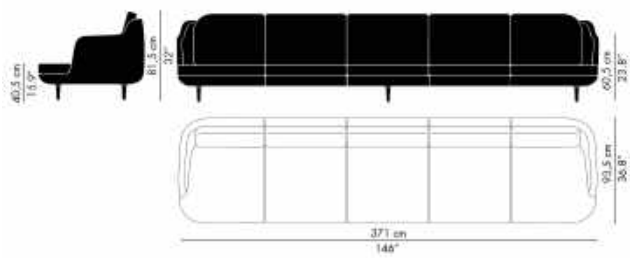

JH600

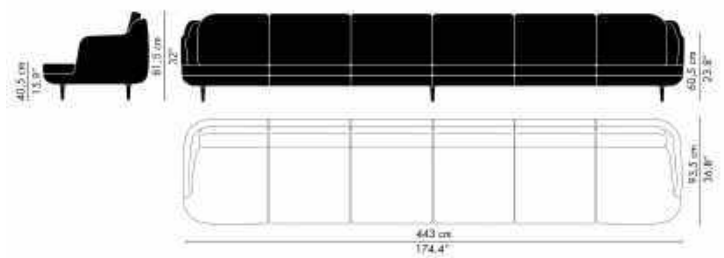

JH510

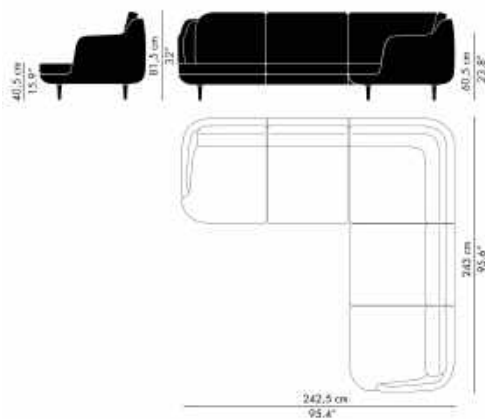

JH610

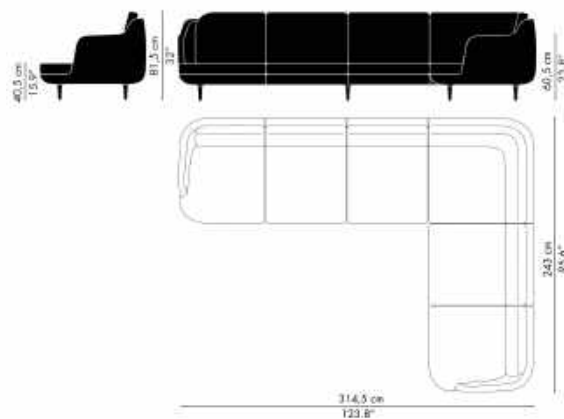

JH001

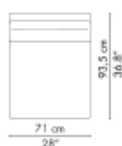

JH002L

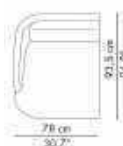

JH002R

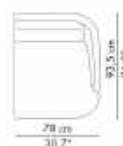

JH003

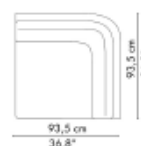

JH004L



JH004R





**RO™ SOFA**  
**JAIME HAYON 2017**

**01.2025**

The Ro™ Sofa comes fully upholstered in a wide range of textiles. As a single textile or a mix of two textiles; one textile for the shell and one for the cushions. The base consists of four legs in brushed aluminium or is available wooden base in solid oak with a clear lacquer finish.

MODEL	DESCRIPTION	CHRISTIANSHAVN	CATEGORY 1	CATEGORY 2
JH110	2-seater sofa, brushed aluminium legs	5.536	5.784	5.784
JH120	2-seater sofa, solid oak base	5.949	6.280	6.280

CATEGORY 1: CANVAS (ONLY CUSHIONS), CAPTURE, DIABLO (ONLY CUSHIONS), FAME, REMIX (ONLY CUSHIONS), TONUS  
 CATEGORY 2: DIVINA, DIVINA MELANGE, DIVINA MD, FIORD, HALLINGDAL, RE-WOOL, STEELCUT, STEELCUT TRIO, SUNNIVA

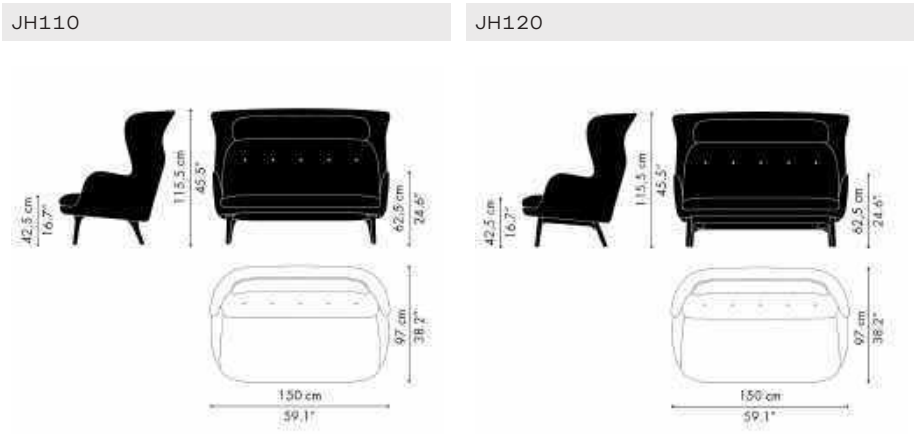





**FRI™ SOFA**  
**JAIME HAYON 2024**

**01.2025**

Fri™ is offered as a lounge chair, sofa, and footstool, and is fully upholstered in a diverse selection of textiles. Choose between tapered legs in aluminium or solid oak, and opt for a single textile or a combination of two textiles.

MODEL	DESCRIPTION	CHRISTIANSHAVN	CATEGORY 1	CATEGORY 2
JH140	2-seater sofa, brushed aluminium legs	3.470	3.718	4.048
JH150	2-seater sofa, solid oak legs	3.470	3.718	4.048

CATEGORY 1: CANVAS, CAPTURE, DIABLO, FAME, REMIX, TONUS  
 CATEGORY 2: DIVINA, DIVINA MD, DIVINA MELANGE, FIORD, HALLINGDAL, RE-WOOL, STEELCUT, STEELCUT TRIO, SUNNIVA, VIDAR

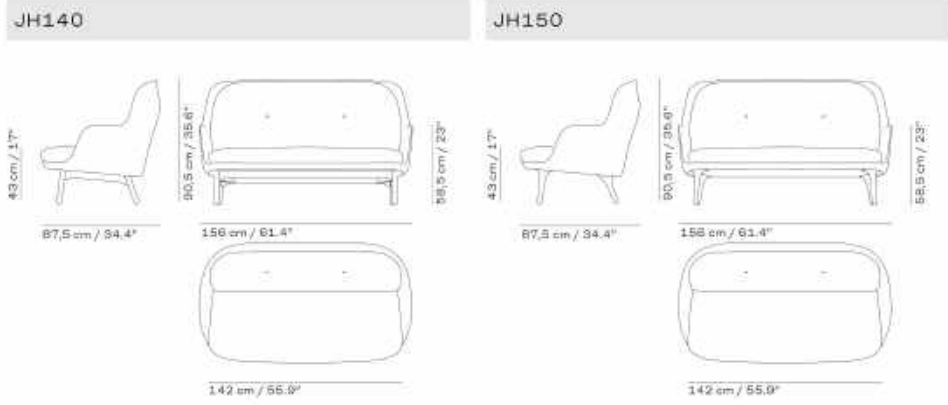



**PLENUM™**  
**JAIME HAYON 2018**

**01.2025**

Plenum™ is a high-back sofa system available in one-, two-, or three-seater versions, as well as a Cabin model. The standard sofa options include features such as power plugs and mounted side tables, with two table variants available. The Plenum Cabin supports optional screen mounting plate, power plugs, USB ports, and additional table options.

**SOFAS**

MODEL	DESCRIPTION	CHRISTIANSHAVN	CATEGORY 1	CATEGORY 2
JH1001	1-seater sofa, black powder coated steel base	5.040	5.288	5.701
JH1002	2-seater sofa, black powder coated steel base	6.528	6.858	7.354
JH1003	3-seater sofa, black powder coated steel base	7.685	8.098	8.676

CATEGORY 1: CANVAS, CAPTURE, FAME, REMIX, TONUS  
 CATEGORY 2: DIVINA, DIVINA MELANGE, DIVINA MD, FIORD, HALLINGDAL, RE-WOOL, STEELCUT, STEELCUT TRIO, SUNNIVA

**CABIN**

MODEL	DESCRIPTION	CHRISTIANSHAVN	CATEGORY 1	CATEGORY 2
JH1004M	4-seater cabin, black powder coated steel base	13.635	14.048	14.461
JH1004MUT	4-seater cabin with table (JH71), black powder coated steel base	14.048	14.461	14.875
JH1004M	4-seater cabin with table (JH72) and screen-ready, black powder coated steel base	14.048	14.461	15.288

CATEGORY 1: CANVAS, CAPTURE, FAME, REMIX, TONUS  
 CATEGORY 2: DIVINA, DIVINA MELANGE, DIVINA MD, FIORD, HALLINGDAL, RE-WOOL, STEELCUT, STEELCUT TRIO, SUNNIVA

**TABLES**

MODEL	DESCRIPTION	LAMINATE (POLYREY)
JH70	Side sofa table, light grey laminate, black powder coated steel base	792
JH71	Table, light grey laminate, without power solution, black powder coated steel base	577
JH72	Table, light grey laminate, with power solution, black powder coated steel base	-
JH75	Coffee table, light grey laminate, black powder coated steel base	990
JH80	Table, light grey laminate, black powder coated steel base	1.114

JH70 MUST BE ORDERED TOGETHER WITH SOFA AND IS NOT INTERCHANGEABLE

**OPTIONS**

DESCRIPTION	PRICE
PU01, Power unit for sofa, black (1 pcs., available in select markets only)	470



JH1001



JH1002



JH1003

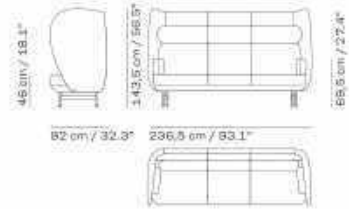

JH1004MU

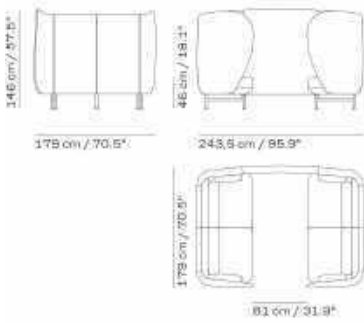

JH1004MUT (JH71)



JH1004MUTS (JH72)



JH70

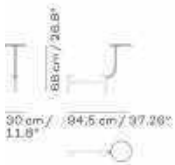

JH75

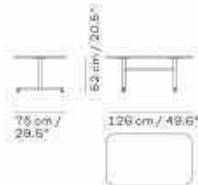

JH80

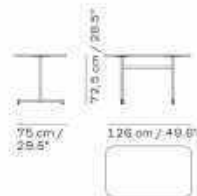

PU01



PU02





**SUPERELLIPSE™**  
PIET HEIN/BRUNO MATHSSON 1968

01.2025

The Superellipse™ tables are available in various sizes and with a tabletop made of either Fenix laminate or clear lacquered walnut veneer. While laminate versions come with an aluminium edge, the walnut veneer versions come with a natural wooden edge. The table's iconic span legs are available either in chromed or powder coated steel.

**DINING TABLES (HEIGHT 72 CM)**

MODEL	DESCRIPTION	FENIX LAMINATE	CLEAR LACQUERED WALNUT	H/L/W
B611	Table, span legs, detachable	1.817	2.643	72/135/90
B612	Table, span legs, detachable	1.982	2.809	72/150/100
B616	Table, span legs, detachable	2.147	3.139	72/170/100
B613	Table, span legs, detachable	2.313	3.470	72/180/120
B614	Table, span legs, detachable	3.057	4.544	72/240/120
B617	Table, span legs, detachable	4.709	7.106	72/300/130
B6180	Table, span legs, detachable	2.395	3.552	72/180/100
B6200	Table, span legs, detachable	2.726	3.966	72/200/100
B6240	Table, span legs, detachable	3.139	4.709	72/240/100

**EXTENSION TABLES (HEIGHT 72 CM)**

MODEL	DESCRIPTION	FENIX LAMINATE	CLEAR LACQUERED WALNUT	H/L/W
B620	Table, span legs, detachable	4.296	6.776	72/170(270)/100
B619	Table, span legs, detachable	4.544	7.519	72/180(300)/120

**OPTIONS**

DESCRIPTION	PRICE
Span legs, table height 52 cm (B2), 70 cm (B4) or 74 cm (B8)	98

FENIX LAMINATE COLOURS - SEE THE SURFACE SELECTION  
WHITE, GREY, BLACK, BROWN OTTAWA, GREY BROMO, GREY EFESO

SPAN LEGS COLOURS  
SILVER GREY, WARM GRAPHITE, BROWN BRONZE, BLACK, WHITE, CHROME



B611

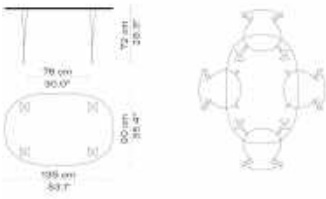

B612

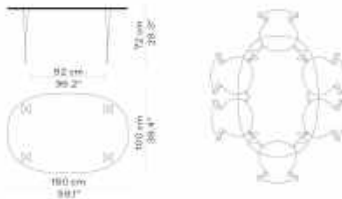

B616

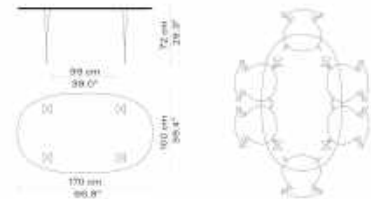

B613

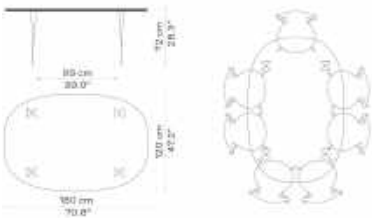

B614

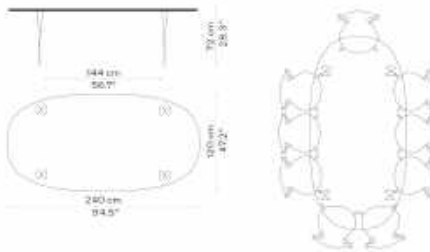

B617

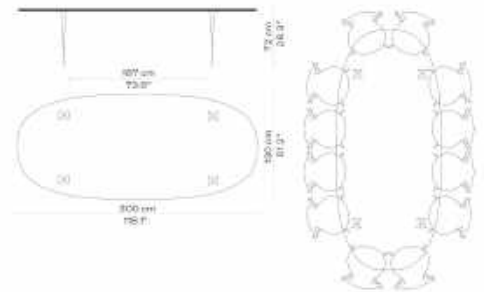

B6180

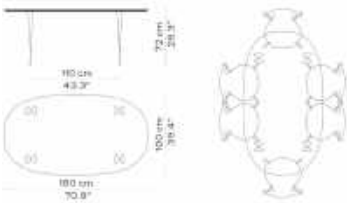

B6200

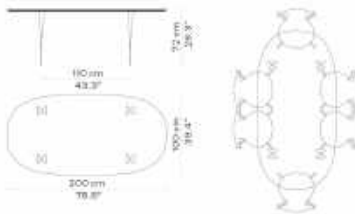

B2640

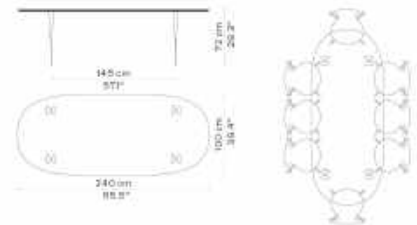

B620

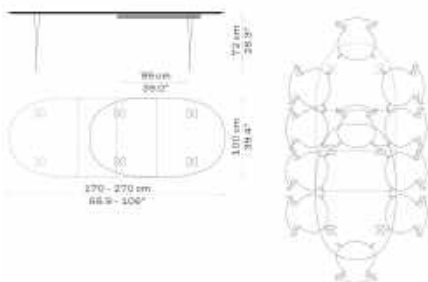

B619

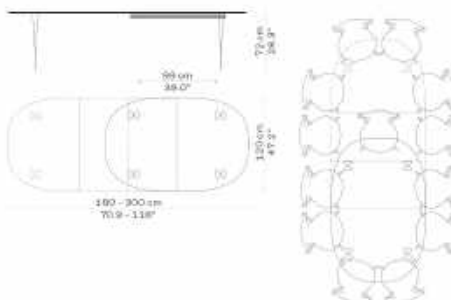





The Circular tables are available in various sizes and with a tabletop made of either Fenix laminate or clear lacquered walnut veneer. While laminate versions come with an aluminium edge, the walnut veneer versions come with a natural wooden edge. The four-star base is made of either satin brushed aluminium with a satin chromed steel pedestal or powder coated aluminium with matching steel pedestal. The Circular tables are also configurable as coffee or bar table.

**DINING TABLES (HEIGHT 72 CM)**

MODEL	DESCRIPTION	FENIX LAMINATE	CLEAR LACQUERED WALNUT	H/Ø
A622	Table, pedestal base, 4-star	1.362	1.817	72/75
A623	Table, pedestal base, 4-star	1.610	2.065	72/90
A825	Table, pedestal base, 6-star	2.395	3.139	72/120
A826	Table, pedestal base, 6-star	3.139	3.718	72/145

**COFFEE TABLES (HEIGHT 47 CM)**

MODEL	DESCRIPTION	FENIX LAMINATE	CLEAR LACQUERED WALNUT	H/Ø
A222	Coffee table, pedestal base, 4-star	1.238	1.610	47/75
A223	Coffee table, pedestal base, 4-star	1.445	1.900	47/90

**BAR TABLE (HEIGHT 108 CM)**

MODEL	DESCRIPTION	FENIX LAMINATE	CLEAR LACQUERED WALNUT	H/Ø
A922	Bar table, pedestal base, 4-star	1.528	1.900	108/75

FENIX LAMINATE COLOURS - SEE THE SURFACE SELECTION  
WHITE, GREY, BLACK, BROWN OTTAWA, GREY BROMO, GREY EFESO

PEDESTAL BASE COLOURS  
SILVER GREY, BROWN BRONZE, BLACK, SATIN BRUSHED ALUMINIUM

**OPTIONS**

DESCRIPTION	PRICE
Pedestal base 4-star, table height 47 cm (A2), 70 cm (A4), Table height 108 cm (A9 - only for Ø 75 cm table top)	98

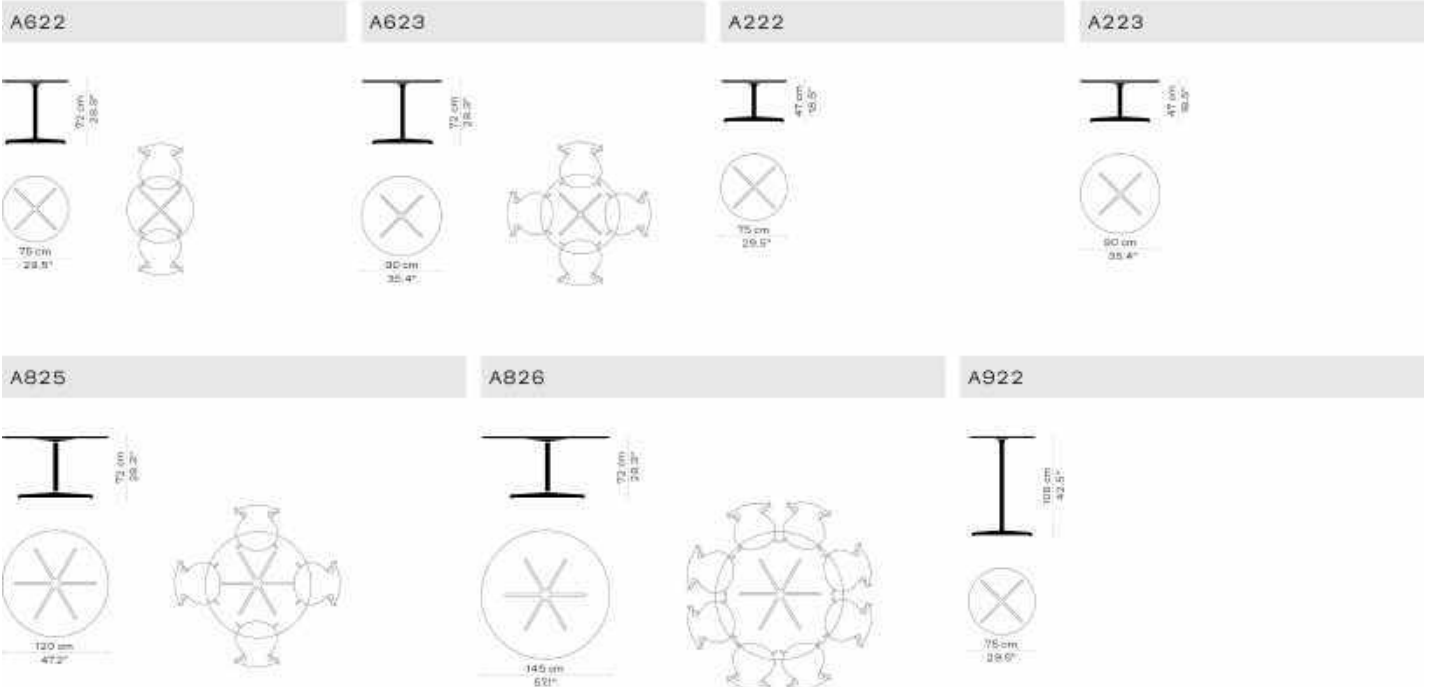



**RECTANGULAR**  
**PIET HEIN/BRUNO MATHSSON/ARNE JACOBSEN 1968**

01.2025

The Rectangular tables are available in two sizes and with a tabletop made of either Fenix laminate or clear lacquered walnut veneer. While laminate versions come with an aluminium edge, the walnut veneer versions come with a natural wooden edge. The table's iconic span legs are available either in chromed or powder coated steel.

**DINING TABLES (HEIGHT 72 CM)**

MODEL	DESCRIPTION	FENIX LAMINATE	CLEAR LACQUERED WALNUT	H/L/W
B637	Table, span legs, detachable	1.817	2.726	72/140/80
B638	Table, span legs, detachable	2.065	2.891	72/160/80

**OPTIONS**

DESCRIPTION	PRICE
Span legs, table height 52 cm (B2), 70 cm (B4) or 74 cm (B8)	98

**FENIX LAMINATE COLOURS - SEE THE SURFACE SELECTION**  
 WHITE, GREY, BLACK, BROWN OTTAWA, GREY BROMO, GREY EFESO

**SPAN LEGS COLOURS**  
 SILVER GREY, WARM GRAPHITE, BROWN BRONZE, BLACK, WHITE, CHROME

**B637**

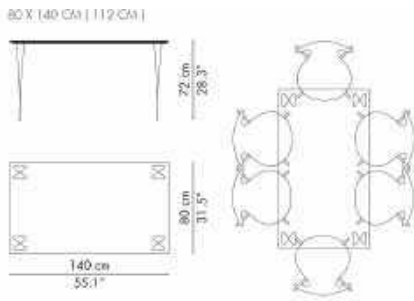

**B638**

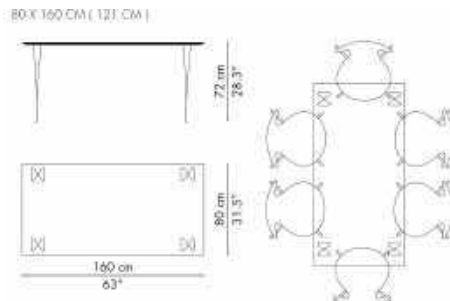





**EGG™ TABLE**  
**ARNE JACOBSEN 1952**

01.2025

The Egg™ Table is crafted with an FSC-certified clear lacquered walnut veneer tabletop. Resting on three chromed steel legs, the elliptical design is equally purposeful as a kitchen or dining table in smaller spaces as it is in a home office. It fits seamlessly into any setting.

MODEL	DESCRIPTION	CLEAR LACQUERED WALNUT	H/L/W
3603	Table, 3 legs, chromed tubular steel	1.982	74/115/84

3603 H72

3603 H74

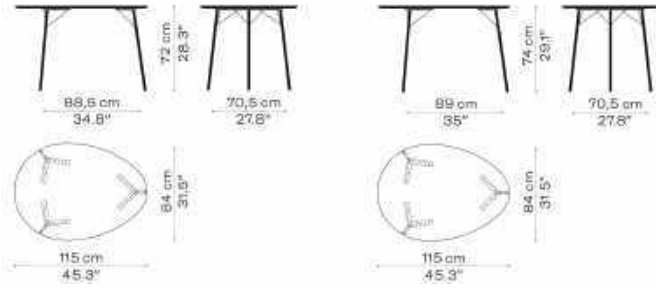



**FH3605™**  
ARNE JACOBSEN 1955

01.2025

The FH3605™ table or "Writing Desk" is a rectangular table available in either black coloured ash or clear lacquered walnut veneer. The base consists of four legs made of chromed or black powder coated steel with a solid wood detail matching the tabletop. FH3605™ is available with one document drawer in solid wood in walnut or black coloured ash (195). The drawer can be installed in either left or right side.

MODEL	DESCRIPTION	BLACK COLOURED ASH	CLEAR LACQUERED WALNUT	H/L/W
3605DD	Desk with drawer, veneer table top, chromed or powder coated steel, table height 72 cm or 74 cm	2.726	2.891	72/152/80
3605DE	Desk, veneer table top, chromed or powder coated steel, table height 72 cm or 74 cm	2.230	2.478	72/152/80
3605DR	Drawer, solid wood	486	544	8/52/30

FH3605DD

FH3605DE

FH3605DR

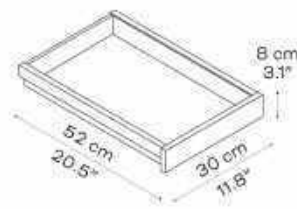
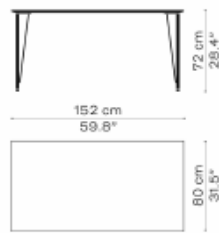
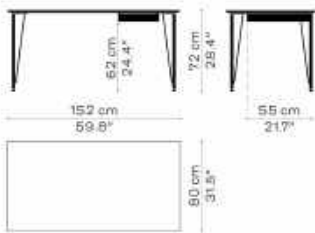



**AJ TROLLEY™**  
**ARNE JACOBSEN 1955/2020**

**01.2025**

The AJ Trolley™ is a small table with triangular tabletops with a black coloured ash veneer finish. While the tabletops are made of veneered medium-density fiberboard, the frame is made of brushed stainless steel and comes with castors with a metal housing.

MODEL	DESCRIPTION	PRICE
840410	Trolley, black coloured ash (195), brushed stainless steel	676
840412	Trolley, clear lacquered walnut veneer, brushed stainless steel	742

**840410**

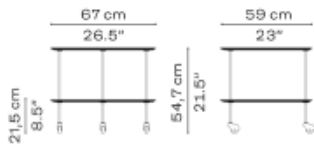



The Essay™ table comes in three sizes and is made of solid oak which is treated with either natural or white pigmented oil. The Essay™ extension leaf comes in two widths and is available in black Fenix laminate.

MODEL	DESCRIPTION	NATURAL OAK	WHITE PIGMENTED OAK	H/L/W
CM21	Table, solid oak	4.048	4.048	72/218/95
CM27	Table, solid oak	5.371	5.371	72/272/100
CM31	Table, solid oak	6.776	6.776	72/317/100

**EXTENSION LEAF**

MODEL	DESCRIPTION	BLACK FENIX LAMINATE	L/W
CM95	Extension leaf, black laminate tabletop	619	48/95
CM100	Extension leaf, black laminate tabletop	619	48/100

**CM21**

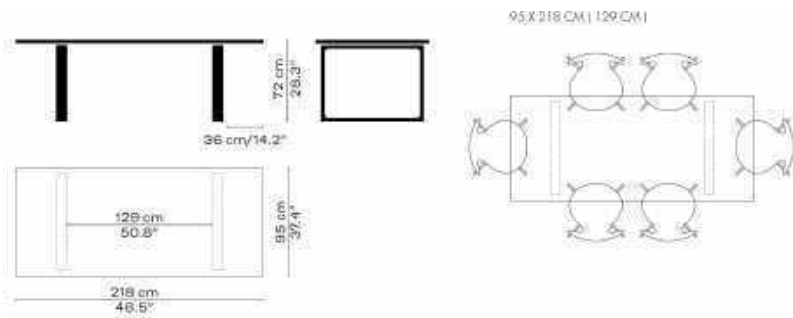

**CM21 + 2/CM95**

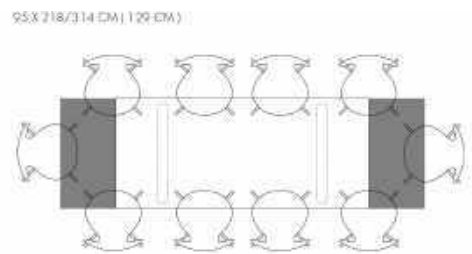

**CM27**

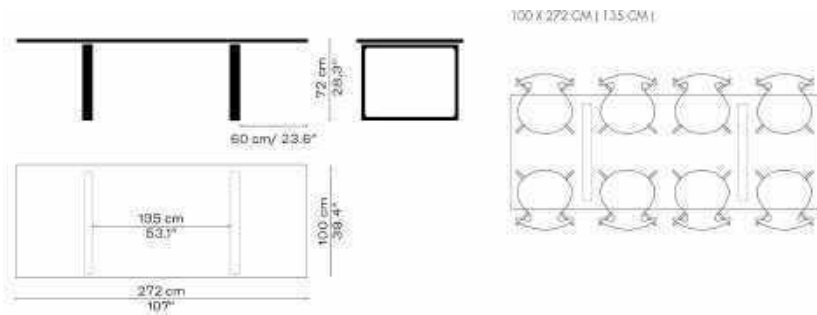

**CM27 + 2/CM100**

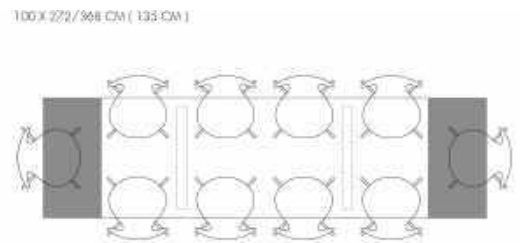



CM31

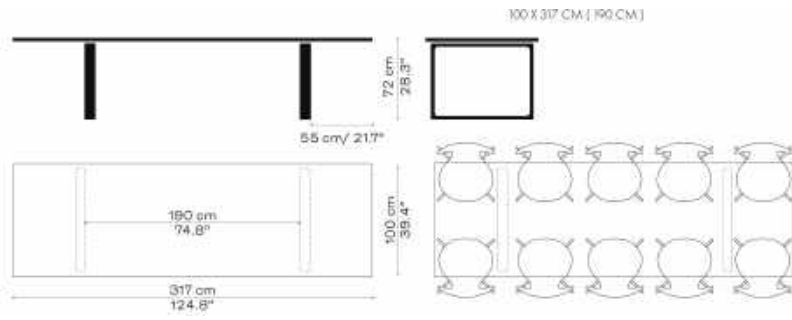

CM31 + 2/CM100

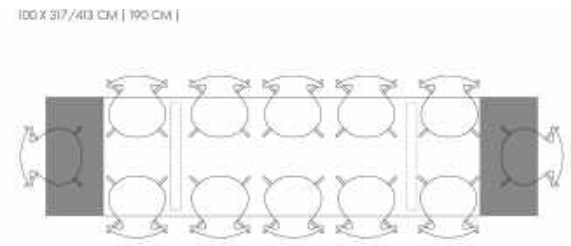

CM95



CM100





The Analog™ table series consists of a dining table, coffee table and side table. The tabletops share a distinctive shape and are crafted in both laminate and veneer versions. The legs are solid wood and are attached to the tabletop with an elegant 'trumpet'.

MODEL	DESCRIPTION	COLOURED VENEER	CLEAR LACQUERED SOLID WOOD (PFLEIDERER)	LAMINATE	CLEAR LACQUERED VENEER	H/L/W
JH43	Table, laminate or veneer top, legs in solid wood	-	-	1.528	1.817	72/130/105
JH63	Table, laminate or veneer top, legs in solid wood	-	-	1.817	2.230	72/185/105
JH83	Table, laminate or veneer top, legs in solid wood	-	-	2.147	2.809	72/245/105
JH93	Table, laminate top, legs in solid wood	-	-	1.404	-	72/110/110
JH43A	Side table, top and legs in solid oak wood		825			43/47,5/62
JH63A	Coffee table, veneer top, legs in solid wood (only available in walnut)	1.156	-		1.321	36/79/103,5

TABLE WITH TABLETOP IN WHITE LAMINATE OR CLEAR LACQUERED OAK VENEER IS AVAILABLE WITH LEGS IN CLEAR LACQUERED OAK AND WHITE TRUMPETS.  
TABLE WITH TABLETOP IN CLEAR LACQUERED WALNUT VENEER IS AVAILABLE WITH LEGS IN BLACK COLOURED OAK OR CLEAR LACQUERED WALNUT, BOTH WITH BLACK TRUMPETS.

**JH43** **JH63**

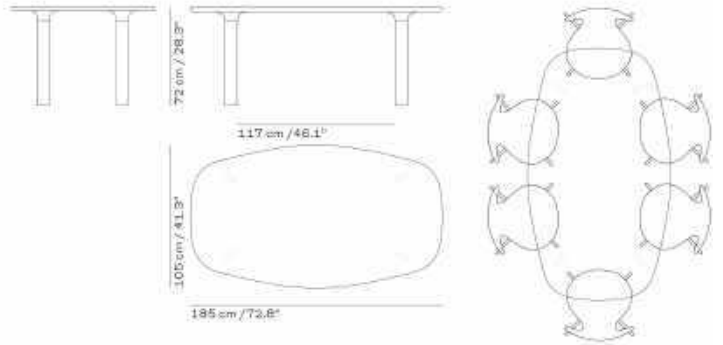
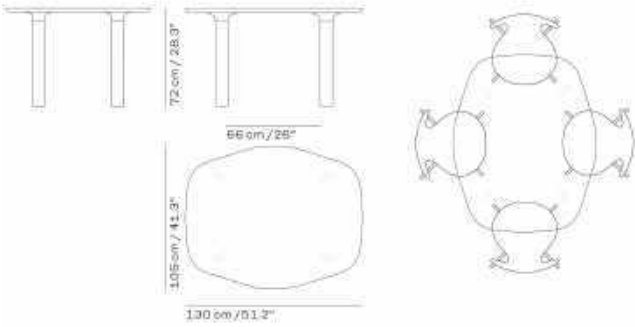

**JH83** **JH93**

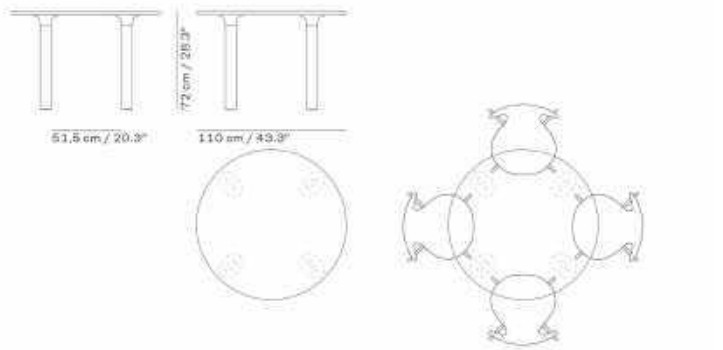
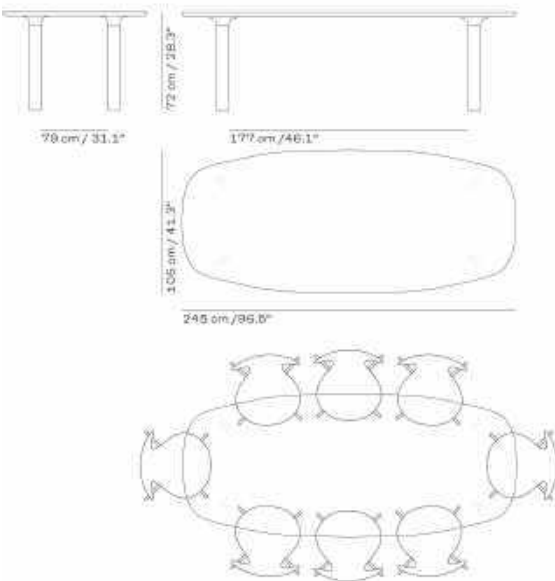

**JH43A** **JH63A**

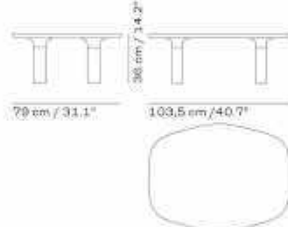
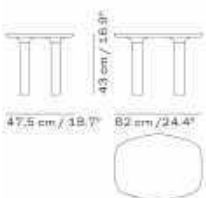



**PLURALIS™**  
KASPER SALTO 2016

01.2025

The Pluralis™ table comes in a wide range of sizes and with five different table tops: Mauve Brown linoleum, Lava Grey or white laminate (Polyrey) and clear lacquered oak or walnut veneer. The base is made of die-cast aluminium and comes with a polished or powder coated finish. The base is mounted with adjustable glides. Electrification and cable management are optionally available.\*

MODEL	DESCRIPTION	LAMINATE (POLYREY)	LINOLEUM	VENEER: OAK	VENEER: WALNUT
KS430	Table, rectangular, polished or powder coated aluminium, 80 cm x 160 cm	1.652	1.982	2.643	2.643
KS431	Table, rectangular, polished or powder coated aluminium, 80 cm x 180 cm	1.900	2.313	2.891	2.891
KS432	Table, rectangular, polished or powder coated aluminium, 100 cm x 200 cm	2.065	2.478	3.222	3.304
KS433	Table, rectangular, polished or powder coated aluminium, 100 cm x 220 cm	2.313	2.643	3.222	3.304
KS434	Table, rectangular, polished or powder coated aluminium, 100 cm x 240 cm	2.478	2.974	3.883	3.966
KS434A	Table, rectangular, polished or powder coated aluminium, 100 cm x 240 cm	2.974	3.552	4.627	4.709
KS435	Table, rectangular, polished or powder coated aluminium, 120 cm x 320 cm	3.304	3.966	5.205	5.288
KS436	Table, rectangular, polished or powder coated aluminium, 120 cm x 480 cm	4.957	5.949	7.767	7.933
KS437	Table, wall-mounted tapered, polished or powder coated aluminium, 80/120 cm x 120 cm	3.800	4.048	4.627	4.709
KS438	Table, tapered, polished or powder coated aluminium, 80/120 cm x 240 cm	4.048	4.379	4.957	4.957
KS439	Table, double tapered, polished or powder coated aluminium, 80/120 cm x 480 cm	6.280	6.528	6.941	7.023

LAMINATE COLOURS:  
WHITE, LAVA GREY

LINOLEUM COLOURS:  
MAUVE BROWN

CLEAR LACQUERED VENEER:  
Oak, Walnut

BASE COLOURS:  
BROWN BRONZE, BLACK, POLISHED ALUMINIUM

**ELECTRIFICATION**

DESCRIPTION	PRICE
Power Frame, including 4-module power strip, 28,4 cm x 7,3 cm, stainless steel, 3 m power infeed cable	470
Top Frame including 4-module power strip, 30,3 cm x 9,4 cm, with lid matching the tabletop, 3 m power infeed cable	1.445
Rectangular cable well, L 32,5 cm x W 13 cm, incl. cut out, aluminium (1 pcs.)	214
Round cable well, Ø 8,8 cm, incl. cut out, aluminium (1 pcs)	214
Cable tray, 65 cm, black powder coated steel	180
Cable hose, 78-125 cm, black or silver	180
Cut out for customer's own electrification solution is available, with pricing determined on a case-by-case basis.	

\*POWER FRAME AND TOP FRAME AVAILABLE IN EU, GB, CH, KR, JP, AND CN



KS430

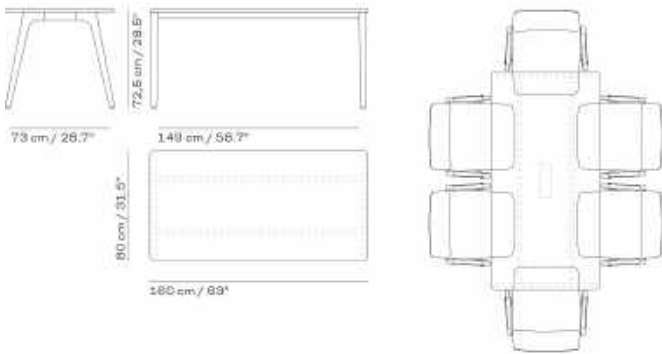

KS431

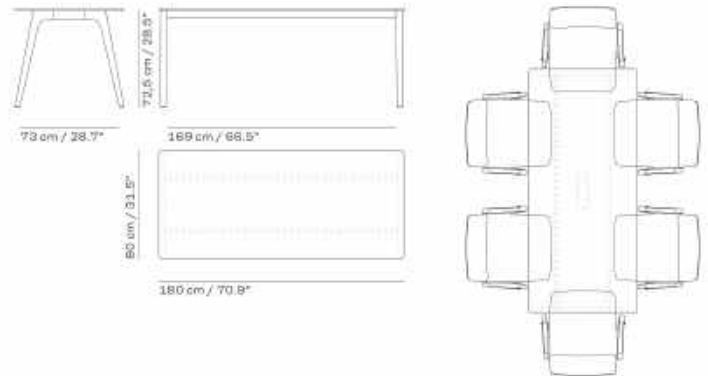

KS432

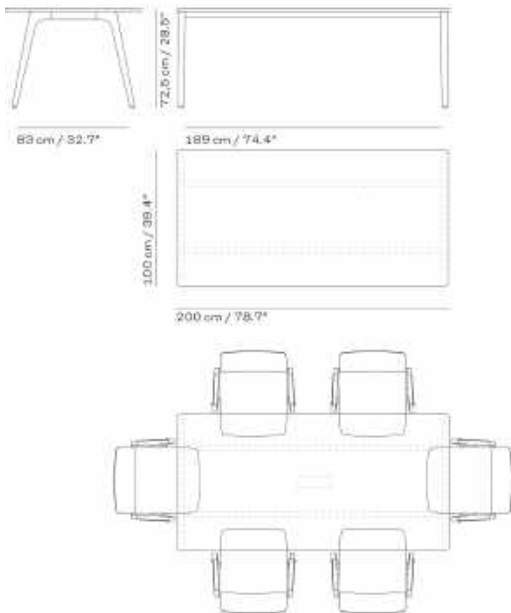

KS433

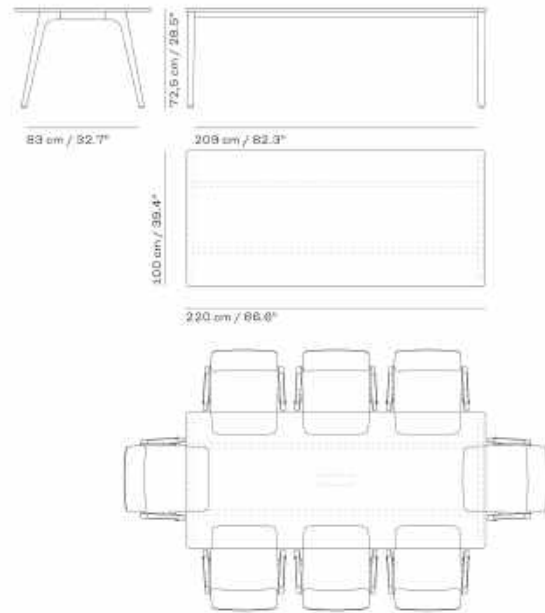

KS434

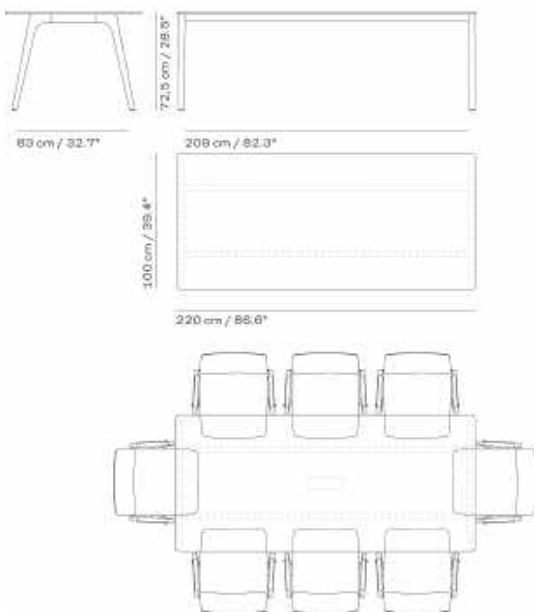

KS434A

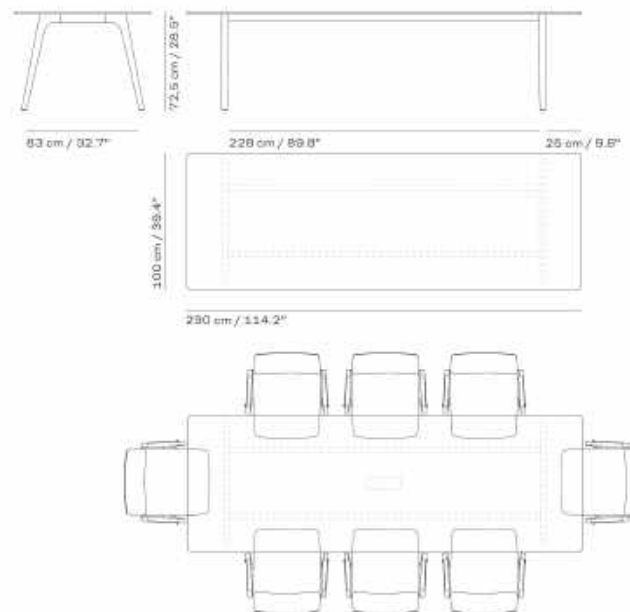





KS435

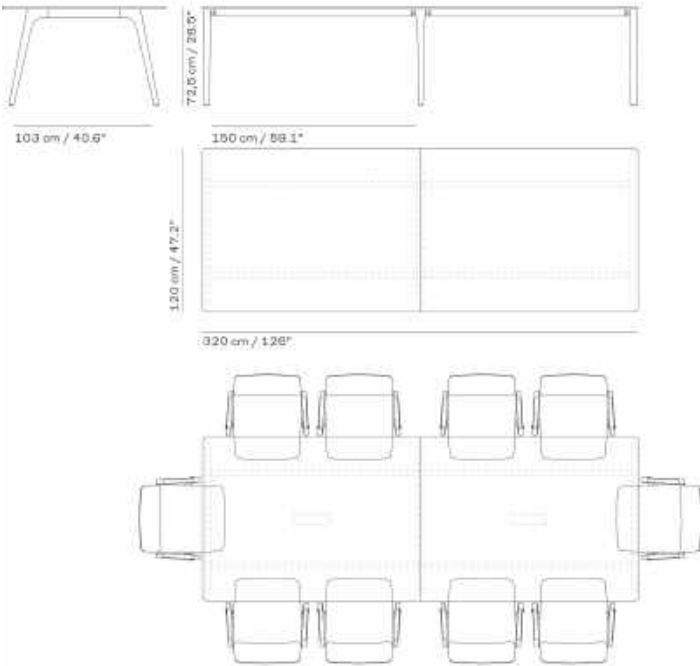

KS436

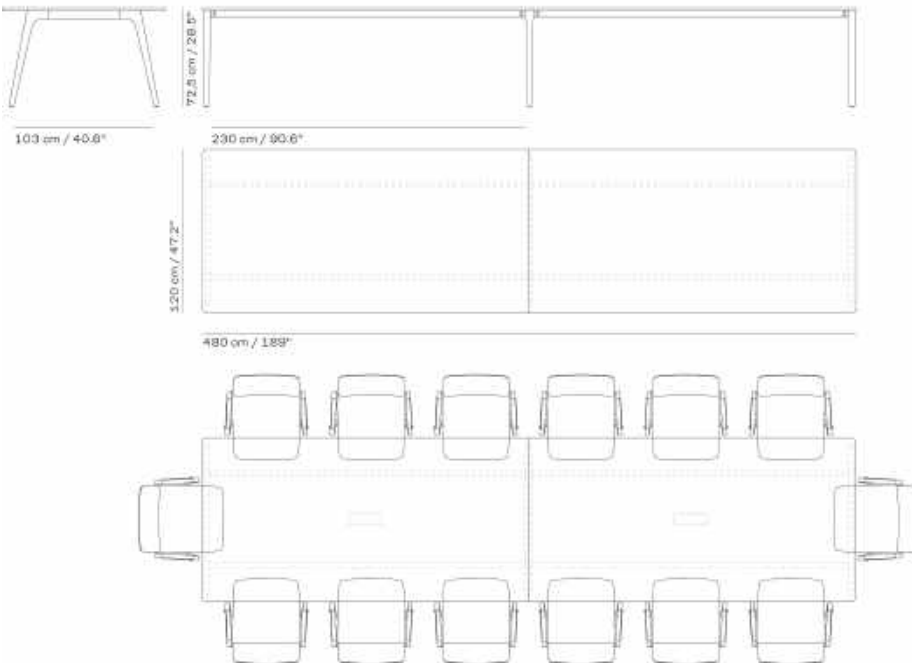



KS437

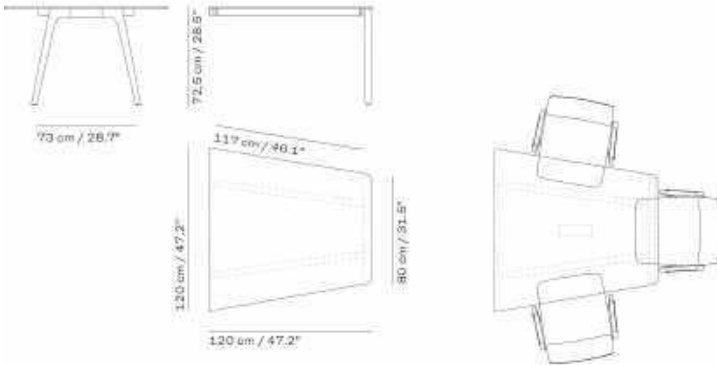

KS438

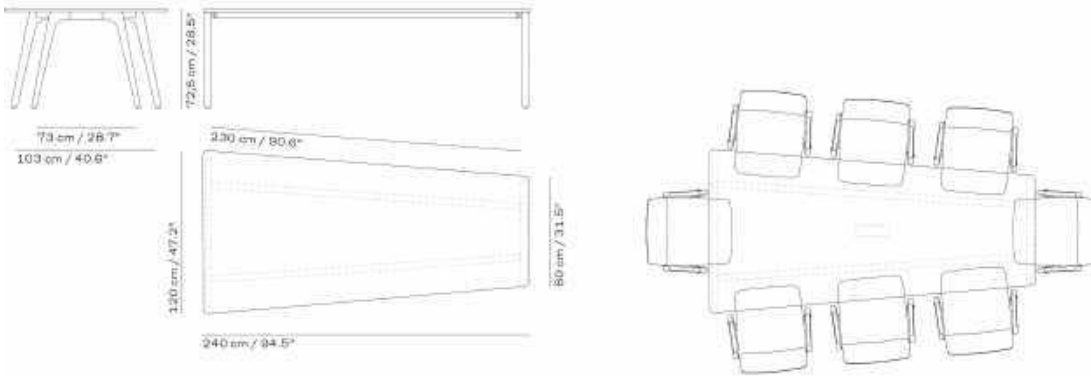

KS439

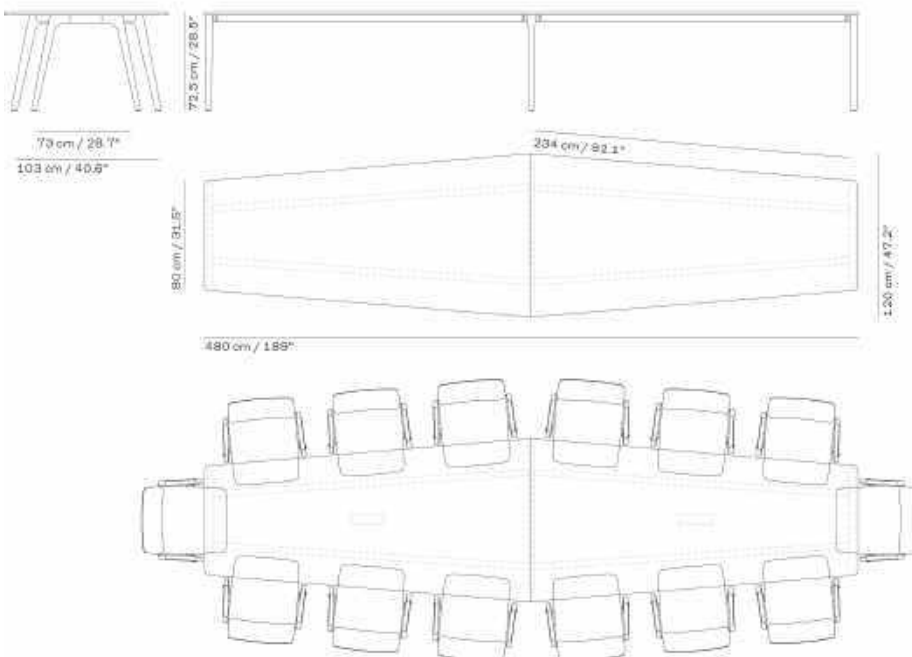



**LITTLE FRIEND™**  
**KASPER SALTO 2005**

01.2025

The Little Friend™ table is available as a height-adjustable or fixed height version. The tabletop comes in compact laminate with four different finishes: Black, white, Oak or Walnut. The base is made of a die-cast aluminium foot that is connected to a steel column. The configurable base finishes in chrome column/polished foot, lacquered black or white depending on the tabletop.

MODEL	DESCRIPTION	BLACK, WHITE	OAK, WALNUT	H/Ø
KS11	Table, Ø45 cm, height adjustable, chromed/polished or powder coated base	1.156	1.280	50 - 73/45
KS12	Table, Ø45 cm, fixed height, chromed/polished or lacquered base	776	866	60/45
KS13	Table, height adjustable, chromed/polished or lacquered base	1.156	1.280	
KS14	Table, fixed height, chromed/polished or lacquered base	784	866	

TABLE WITH A TABLETOP IN WHITE IS AVAILABLE WITH A WHITE OR CHROMED/POLISHED BASE.  
TABLE WITH A TABLETOP IN BLACK, OAK OR WALNUT IS AVAILABLE WITH A BLACK OR CHROMED/POLISHED BASE.

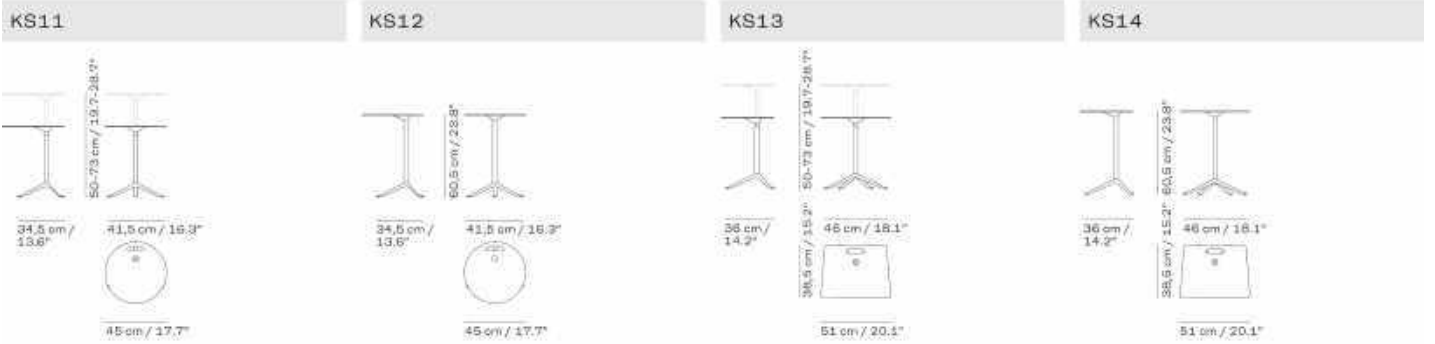



**PLANNER™ TABLE SERIES**  
**PAUL MCCOBB 1952/2018**

**01.2025**

The Planner™ Table Series consists of coffee tables in six different sizes. The honed marble tabletop is available in two colours: Cream or Charcoal. The base consists of a frame in black powder coated steel.

MODEL	DESCRIPTION	MARBLE	H/L/W
MC300	Circular coffee table, marble top, powder coated base	1.404	40/80/80
MC310	Rectangular coffee table, marble top, powder coated steel base	1.114	40/75/45
MC320	Square coffee table, marble top, powder coated steel base	1.404	40/80/80
MC330	Square coffee table, marble top, powder coated steel base	990	40/45/45
MC340	Square coffee table, marble top, powder coated steel base	2.147	40/100/100
MC350	Rectangular coffee table, marble top, powder coated steel base	1.941	40/130/70

MARBLE COLOURS - SEE THE SURFACE SELECTION  
 CREAM, CHARCOAL

MC300

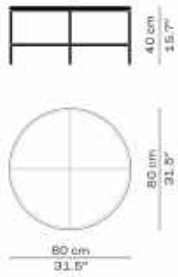

MC310

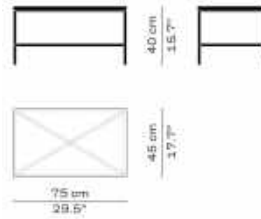

MC320

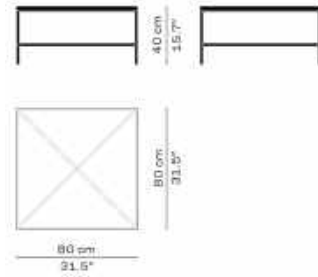

MC330

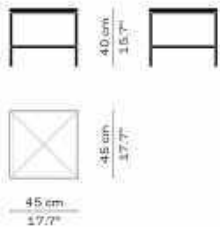

MC340

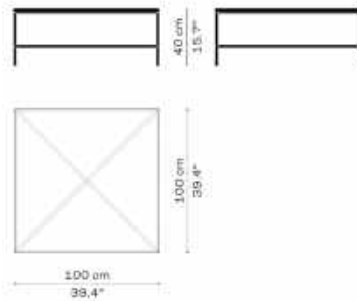

MC350

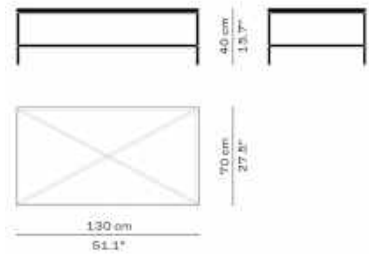



**PLANNER™ SHELVING**  
PAUL MCCOBB 1952/2019

01.2025

The Planner™ Shelving Series comes in three sizes with shelves in clear lacquered oak veneer and a black powder coated steel frame.

MODEL	DESCRIPTION	CLEAR LACQUERED OAK	H/L/W
MC500	Shelving, small, oak veneer, powder coated steel frame	1.238	84,4/120,7/38,1
MC510	Shelving, medium, oak veneer, powder coated steel frame	1.528	123,2/120,7/38,1
MC520	Shelving, large, oak veneer, powder coated steel frame	1.817	165/120,7/38,1

MC500

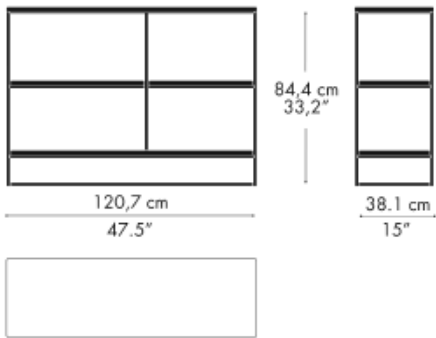

MC510

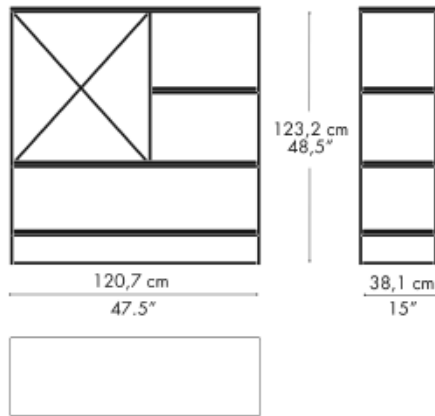

MC520

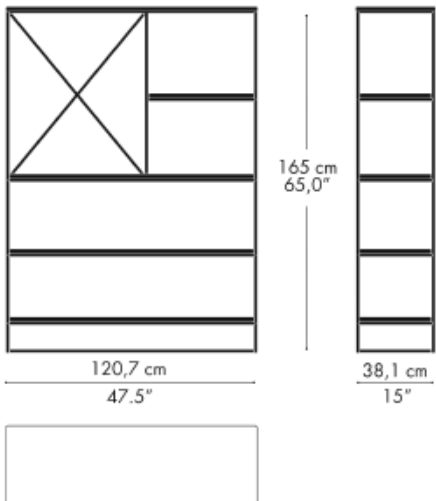



**COAT TREE™ / COAT TREE™ WALL**  
SIDSE WERNER 1971/2019

01.2025

The Coat Tree™ has a free standing and wall mounted variant consisting of eight or four bent steel tubes with round moulded plastic knobs.

MODEL	DESCRIPTION	PRICE
840332	Coat Tree, Chrome / Black knobs	1.114
840330	Coat Hanger, Light Grey / Grey knobs	321
840331	Coat Hanger, Dark Blue / Black knobs	321

840332

840330/840331

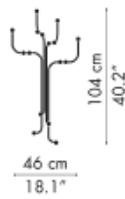



A selection of spare parts for chairs, lounge furniture and tables. Items are sold in colli unless stated otherwise.

**CHAIRS**

DESCRIPTION	PRICE
Glides for Ant™, Series 7™, Grand Prix™ and Lily™, Black. 1 colli (24 pcs)	3
Glides w/felt for Ant™, Series 7™, Grand Prix™ and Lily™, Black. 1 colli (24 pcs)	3
Glides for Grand Prix™ (4130) wooden base. 1 colli (24 pcs)	3
Glides w/felt for Grand Prix™ (4130), wooden base. 1 colli (24 pcs)	3
Hard castor for soft floors with alu cap for Series 7™, no brake	15
Soft castor for hard floors with alu cap for Series 7™, no brake	15
Hard castor for soft floors with alu cap and tap for Series 7™ produced before 2003, no brake	15
Soft castor for hard floors with alu cap and tap for Series 7™ produced before 2003, no brake	15
Hard castor for soft floors with alu cap for Oxford™, no brake	15
Soft castor for hard floors with alu cap for Oxford, no brake	15
Spacer for Ant™, Series 7™, Grand Prix™, Lily™, High Dot™ & Dot™, Black or Grey rubber. 1 colli (24 pcs)	3
Cover for Ant™, Series 7™, Grand Prix™, Lily™ & Dot™ (4-legs), Black plastic. 1 colli (6 pcs)	11
Cover for Ant™ & High Dot™ (3-legs), Black plastic. 1 colli (6 pcs)	11
Chair base 4 legs, seat height 43 cm, 46 cm or 48 cm, for Ant™, Series 7™ & Grand Prix™, chromed or powder coated steel	205

FERRULE / FERRULE W. FELT

SPACER

COVER



CHAIR BASE

CASTOR (SERIES 7™)

CASTOR (OXFORD™)



**LOUNGE & SOFAS**

DESCRIPTION	PRICE
Glides for the Egg™, Swan™ and Swan sofa™, moulded Black polyamide. 1 colli (4 pcs)	3
Glides with felt for the Egg™, Swan™ and Swan sofa™, moulded Black polyamide. 1 colli (4 pcs)	3
Adjustment handle for the Egg™, polished stainless steel	131

GLIDE

GLIDE W. FELT

ADJUSTMENT HANDLE





TABLES

DESCRIPTION	PRICE
Glide for span legs, transparent plastic. 1 colli (4 pcs)	7
Span legs (set of 4 pcs.), table height 70 cm (B4), without mounting plate, chromed or powder coated steel	734
Span legs (set of 4 pcs.), table height 72 cm (B6), without mounting plate, chromed or powder coated steel	734
Pedestal base 4-star, table height 47 cm (A2), satin brushed aluminium, satin chromed pedestal	784
Pedestal base 4-star, table height 72 cm (A6), satin brushed aluminium, satin chromed pedestal	784
Pedestal base, 4-star, table height 108 cm (A9), satin brushed aluminium, satin chromed pedestal	784
Pedestal base, 6-star, table height 72 cm (A8), satin brushed aluminium, satin chromed pedestal	1.652
Laminate cleaner for White laminate. 1 colli (6 pcs)	106
Cleaning sponges for laminate tabletops. 1 colli (10 pcs)	11
Essay™ oil kit, natural (1 pcs)	69
Essay™ oil kit, White pigmented (1 pcs)	69
Stonewash for marble tables (1 pcs)	36

SPAN LEGS	A2	A6	A8	A9
-----------	----	----	----	----



GLIDER SPAN LEGS	LAMINATE CLEANER	ESSAY OIL KIT	STONE WASH	CLEANING SPONGES
------------------	------------------	---------------	------------	------------------





# SURFACE SELECTION

# SURFACE SELECTION

## INVENTORY

- 75 • Textiles
- 80 • Leather
- 83 • Seat cushions
- 84 • Wood
- 87 • Plastic
  - Paper cord
- 88 • Laminate
  - Linoleum
  - Marble
- 89 • Powder coated metal
- 90 • Metal

# SURFACE SELECTION

## TEXTILES

Please note that not all textiles are suitable on all the furniture. On each individual model the standard textile options are listed. Some textiles are only available in a selection of colours.

### CUSTOMER'S OWN MATERIAL (COM)

Customers can supply their own textiles. Textile requirements, based on standard textile 130 cm wide, can be given on inquiry. We reserve the right to reject textiles that we find unsuitable for upholstery.

### CATEGORY 1

#### BELFAST (VELVET)

MATERIALS: 100% COTTON  
DURABILITY: 50.000 MARTINDALE  
COLOURS: 10

#### CANVAS

MATERIALS: 90% NEW WOOL (WORSTED), 10% NYLON  
DURABILITY: 100.000 MARTINDALE  
AVAILABLE IN ALL COLOURS

#### CAPTURE

MATERIALS: 85% WOOL, 15% POLYAMIDE  
DURABILITY: 200.000 MARTINDALE  
AVAILABLE IN ALL COLOURS

#### DIABLO

MATERIALS: 54% VISCOSE, 46% COTTON  
DURABILITY: >30.000 MARTINDALE  
AVAILABLE IN ALL COLOURS

#### FAME

MATERIALS: 95% WOOL, 5% POLYAMID  
DURABILITY: 200.000 MARTINDALE  
AVAILABLE IN ALL COLOURS

#### LINARA

MATERIALS: 63% COTTON, 37% LINEN  
DURABILITY: 36.000 MARTINDALE  
COLOURS: 6

#### REMIX

MATERIALS: 90% NEW WOOL (WORSTED), 10% NYLON  
DURABILITY: 100.000 MARTINDALE  
AVAILABLE IN ALL COLOURS

#### RENEWED LOOP

MATERIALS: 100% POST-INDUSTRIAL RECYCLED  
POLYESTER  
DURABILITY: 100.000 MARTINDALE  
COLOURS: 4

#### TONUS

MATERIALS: 90% NEW WOOL, 10% HELANCA  
DURABILITY: 100.000 MARTINDALE  
AVAILABLE IN ALL COLOURS

### CATEGORY 2

#### CLAY

MATERIALS: 76% LINEN, 21% COTTON,  
3% POLYESTER  
DURABILITY: 45.000 MARTINDALE  
COLOURS: 6

#### DIVINA

MATERIALS: 100% NEW WOOL  
DURABILITY: 45.000 MARTINDALE  
AVAILABLE IN ALL COLOURS

#### DIVINA MD

MATERIALS: 100% NEW WOOL  
DURABILITY: 45.000 MARTINDALE  
AVAILABLE IN ALL COLOURS

#### DIVINA MELANGE

MATERIALS: 100% NEW WOOL  
DURABILITY: 45.000 MARTINDALE  
AVAILABLE IN ALL COLOURS

#### FIORD

MATERIALS: 92% NEW WOOL (WORSTED), 8% NYLON  
DURABILITY: 60.000 MARTINDALE  
AVAILABLE IN ALL COLOURS

#### HALLINGDAL

MATERIALS: 70% NEW WOOL, 30% VISCOSE  
DURABILITY: 100.000 MARTINDALE  
AVAILABLE IN ALL COLOURS

#### KARAKORUM

MATERIALS: 42% WOOL, 33% VISCOSE, 24% COTTON,  
1% POLYAMIDE  
DURABILITY: 40.000 MARTINDALE  
AVAILABLE IN ALL COLOURS

#### MOSS

MATERIALS: 52% COTTON, 22% VISCOSE,  
14% POLYACRYLIC, 6% LINEN, 3% POLYESTER,  
3% NYLON  
DURABILITY: 50.000 MARTINDALE  
COLOURS: 6

#### QUAY

MATERIALS: 66% POST-INDUSTRIAL RECYCLED  
COTTON, 27% POLYESTER, 6% RAYON, 1% NYLON  
DURABILITY: 100.000 MARTINDALE  
COLOURS: 1

#### RE-WOOL

MATERIALS: 45% RECYCLED WOOL, 45% NEW WOOL  
(WORSTED), 10% NYLON  
DURABILITY: 100.000 MARTINDALE  
AVAILABLE IN ALL COLOURS

#### SERPENTINE

MATERIALS: 98% NEW WOOL (WORSTED), 2% NYLON  
DURABILITY: 45.000 MARTINDALE  
COLOURS: 6

#### STEELCUT

MATERIALS: 90% NEW WOOL (WORSTED), 10% NYLON  
DURABILITY: 100.000 MARTINDALE  
AVAILABLE IN ALL COLOURS

#### STEELCUT TRIO

MATERIALS: 90% NEW WOOL (WORSTED), 10% NYLON  
DURABILITY: 100.000 MARTINDALE  
AVAILABLE IN ALL COLOURS

#### SUNNIVA

MATERIALS: 58% NEW WOOL, 25% VISCOSE, 8% LINEN,  
5% NYLON, 4% POLYESTER  
DURABILITY: 50.000 MARTINDALE  
AVAILABLE IN ALL COLOURS

#### TWILL WEAVE

MATERIALS: 90% NEW WOOL (WORSTED), 10% NYLON  
DURABILITY: 60.000 MARTINDALE  
AVAILABLE IN ALL COLOURS

#### VANIR

MATERIALS: 92% NEW WOOL (WORSTED), 8% NYLON  
DURABILITY: 100.000 MARTINDALE  
COLOURS: 12

#### VIDAR

MATERIALS: 94% NEW WOOL, 6% NYLON  
DURABILITY: 100.000 MARTINDALE  
AVAILABLE IN ALL COLOURS

### CATEGORY 3

#### SONAR

MATERIALS: 59% NEW WOOL, 25% VISCOSE,  
9% LINEN, 5% NYLON, 2% POLYESTER  
DURABILITY: 20.000 MARTINDALE  
AVAILABLE IN ALL COLOURS

### MISCELLANEOUS

#### JUST

MATERIALS: 98% POST-CONSUMER RECYCLED  
POLYESTER / 2% POLYESTER  
DURABILITY: 70.000 MARTINDALE

#### SALSA

MATERIALS: 100% POLYESTER  
DURABILITY: 200.000 MARTINDALE

# SURFACE SELECTION

## TEXTILES

	BELFAST	CANVAS	CAPTURE	CHRISTIANSHAVN	CLAY	DIABLO	DIVINA	DIVINA MELANGE	DIVINA MD	FAME	FIORD	HALLINGDAL	JUST	KARAKORUM	LINARA	MOSS	QUAY	REMIX	RENEWED LOOP	RE-WOOL	SALSA	SONAR	SERPENTINE	STEELCUT	STEELCUT TRIO	SUNNIVA	TONUS	TWILL WEAVE	VANIR	VIDAR	
ALPHABET™ SOFA SERIES		●	●	●		●	●	●	●	●	●	●		●					●	●				●	●	●	●				
ANT™ FRONT	●	●	●	●		●	●	●	●	●	●	●							●	●				●	●	●	●			●	●
CHINA CHAIR™																															
DOT™																															
DROP™		●	●	●		●	●	●	●	●	●	●							●	●				●	●	●	●				
DROP™ SEAT CUSHION																					●										
EGG™		●	●	●		●	●	●	●	●	●	●								●	●				●	●	●	●			
FAVN™ SHELL/BASE			●	●			●	●	●	●	●	●								●	●				●	●	●	●			
FAVN™ SEAT/BACK		●	●	●		●	●	●	●	●	●	●							●	●					●	●	●	●			
FAVN™ CUSHIONS		●	●	●		●	●	●	●	●	●	●							●	●					●	●	●	●			
FRED™	●			●								●								●	●										
FRI™		●	●	●			●	●	●	●	●	●							●	●					●	●	●	●			●
FRI™ FOOTSTOOL		●	●	●			●	●	●	●	●	●							●	●					●	●	●	●			●
FRI™ SOFA		●	●	●			●	●	●	●	●	●							●	●					●	●	●	●			●
GRAND PRIX™ FRONT		●	●	●		●	●	●	●	●	●	●							●	●					●	●	●	●			●
GRAND PRIX™ FULL		●	●	●		●	●	●	●	●	●	●							●	●					●	●	●	●			●
LET™		●		●			●	●	●	●	●	●							●	●					●	●	●	●			●
LILY™		●	●	●		●	●	●	●	●	●	●							●	●					●	●	●	●			●
LITTLE GIRAFFE™		●	●	●		●	●	●	●	●	●	●							●	●					●	●	●	●			
LITTLE GIRAFFE™ REMOVABLE COVER		●	●	●		●	●	●	●	●	●	●							●	●					●	●	●	●			
LISSONI SOFA™		●	●	●	●	●	●	●	●	●	●	●				●			●	●					●	●	●	●			
LUNE™		●	●	●		●	●	●	●	●	●	●			●				●	●					●	●	●	●			
MONOLIT™				●								●					●						●				●	●	●		●
N02™ RECYCLE SEAT CUSHION													●																		
OXFORD™		●	●	●		●	●	●	●	●	●	●							●	●		●			●	●	●	●			●
PLENUM™		●	●	●			●	●	●	●	●	●							●	●	●				●	●	●	●			
POT™		●	●	●		●	●	●	●	●	●	●							●	●					●	●	●	●			
RO™ SHELL			●	●			●	●	●	●	●	●								●	●				●	●	●	●	●		●
RO™ CUSHIONS		●	●	●		●	●	●	●	●	●	●							●	●					●	●	●	●	●		●
RO™ FOOTSTOOL		●	●	●		●	●	●	●	●	●	●							●	●					●	●	●	●	●		●
RO™ SOFA SHELL			●	●			●	●	●	●	●	●								●	●				●	●	●	●			
RO™ SOFA CUSHIONS		●	●	●		●	●	●	●	●	●	●							●	●					●	●	●	●			
SERIES 7™ FRONT	●	●	●	●		●	●	●	●	●	●	●							●	●					●	●	●	●			●
SERIES 7™ FULL	●	●	●	●		●	●	●	●	●	●	●							●	●					●	●	●	●			●
SERIES 3300™		●	●	●		●	●	●	●	●	●	●							●	●					●	●	●	●			
SWAN™			●	●		●	●	●	●	●	●	●								●	●				●	●	●	●			
SWAN SOFA™			●	●		●	●	●	●	●	●	●								●	●				●	●	●	●			
VIA57™			●	●			●	●	●		●	●								●	●				●	●	●	●			
VICO DUO™ FRONT	●	●	●	●		●	●	●	●	●	●	●							●	●					●	●	●	●			
VICO DUO™ FULL	●	●	●	●		●	●	●	●	●	●	●							●	●					●	●	●	●			
VICO DUO™ SEAT CUSHION													●																		

# SURFACE SELECTION

Colours and materials may vary from the images shown.  
Actual colour, gloss level and structure may vary.

## TEXTILES

### CHRISTIANSHAVN™



Alphabet™ Sofa Series  
Ant™  
Drop™  
Egg™  
Favn™  
Fred™  
Fri™  
Fri™ Sofa  
Grand Prix™  
Let™  
Lily™  
Lissoni Sofa™  
Little Giraffe™  
Lune™  
Monolit™  
Oxford™  
Plenum™  
Pot™  
Ro™  
Ro™ Sofa  
Series 7™  
Series 3300™  
Swan™  
Swan Sofa™  
VIA57™  
Vico Duo™

**MATERIALS:** 85% WOOL, 15% POLYAMID  
**DURABILITY:** 200.000 MARTINDALE  
**LIGHT FASTNESS:** 5-7  
**COLOURS:** 26

Christianshavn™ is a timeless, wool mix textile designed by Fritz Hansen. Its 26 contemporary colours offer an immense variety in both unicolour and melange weave. It has superior comfort due to the wool mix and with its high durability and a 200.000 rubs martindale, it is suitable for all upholstered products in the Fritz Hansen collection. The name; Christianshavn leads back to where it all started. The young enterprising cabinet-maker Fritz Hansen started his furniture production company in Christianshavn - a central part of Copenhagen. Christianshavn can be used in private interiors as well as public areas.

# SURFACE SELECTION

Colours and materials may vary from the images shown.  
Actual colour, gloss level and structure may vary.

## SELECTED TEXTILE COLOURS

### BELFAST (VELVET)



**FOREST GREEN**  
770660  
Ant™  
Fred™  
Series 7™  
Vico Duo™

**MISTY ROSE**  
770593  
Ant™  
Fred™  
Series 7™  
Vico Duo™

**NIGHT BLACK**  
772150  
Ant™  
Fred™  
Series 7™  
Vico Duo™

**DARK PLUM**  
774232  
Ant™  
Fred™  
Series 7™  
Vico Duo™

**SEAL GREY**  
775139  
Ant™  
Fred™  
Series 7™  
Vico Duo™

**SOFT OCHRE**  
774926  
Ant™  
Fred™  
Series 7™  
Vico Duo™

**GREY BROWN**  
771772  
Ant™  
Fred™  
Series 7™  
Vico Duo™



**AUTUMN RED**  
772255  
Ant™  
Fred™  
Series 7™  
Vico Duo™

**GREY BLUE**  
772143  
Ant™  
Fred™  
Series 7™  
Vico Duo™

**MIDNIGHT BLUE**  
772062  
Ant™  
Fred™  
Series 7™  
Vico Duo™

### CLAY

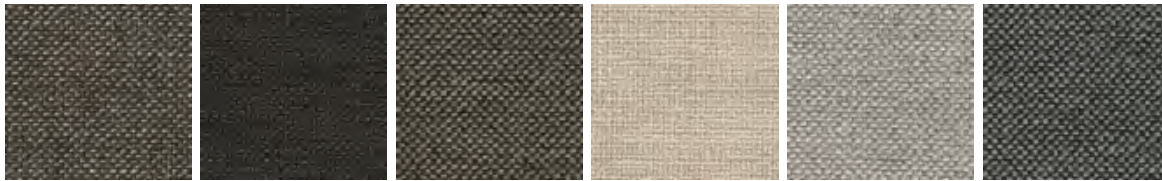

**BROWN**  
0004  
Lissoni Sofa™

**DARK BROWN**  
0005  
Lissoni Sofa™

**DARK SAND**  
0008  
Lissoni Sofa™

**BEIGE**  
0011  
Lissoni Sofa™

**LIGHT GREY**  
0012  
Lissoni Sofa™

**GREY**  
0013  
Lissoni Sofa™

### LINARA



**BLUEBERRY**  
2494/198  
Lune™

**EUCALYPTUS**  
2494/324  
Lune™

**GINGERSNAP**  
2494/118  
Lune™

**GREY MIST**  
2494/340  
Lune™

**INDIGO**  
2494/30  
Lune™

**LEAD**  
2494/237  
Lune™

### MOSS

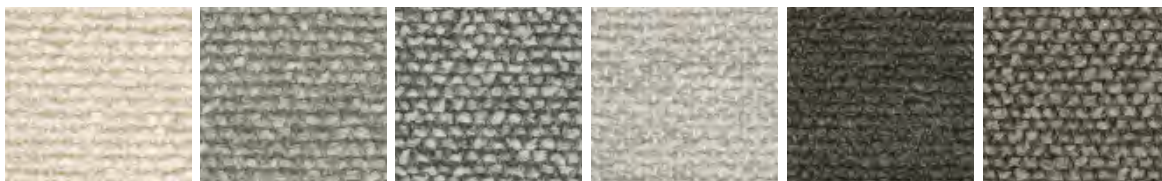

**BEIGE**  
0004  
Lissoni Sofa™

**LIGHT GREY**  
0005  
Lissoni Sofa™

**GREY**  
0006  
Lissoni Sofa™

**SAND/GREY**  
0011  
Lissoni Sofa™

**DARK CLAY**  
0014  
Lissoni Sofa™

**CLAY**  
0015  
Lissoni Sofa™

# SURFACE SELECTION

Colours and materials may vary from the images shown.  
Actual colour, gloss level and structure may vary.

## SELECTED TEXTILE COLOURS

### QUAY



REFINERY  
035  
Monolit™

### RENEWED LOOP

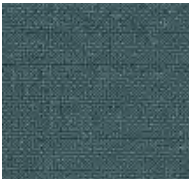

LIGHT PETROL BLUE  
67131  
Plenum™



PETROL BLUE  
67133  
Plenum™

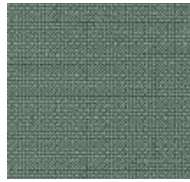

DUSTY LIGHT GREEN  
68290  
Plenum™



MOSS GREEN  
68292  
Plenum™

### SERPENTINE



GREY/BEIGE  
118  
Monolit™



BLACK/GREY  
198  
Monolit™



SAND/PEACH  
238  
Monolit™

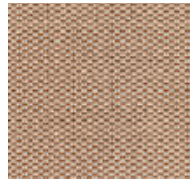

CREME/BRONZE  
428  
Monolit™



BLACK/BLUE  
798  
Monolit™



GREEN/GREY  
988  
Monolit™

### VANIR



BLACK/GREY  
193  
Ant™  
Grand Prix™  
Lily™  
Series 7™



SAND/BLUE  
243  
Ant™  
Grand Prix™  
Lily™  
Series 7™



GRANITE BROWN  
373  
Ant™  
Grand Prix™  
Lily™  
Series 7™



BLACK/MUSTARD  
393  
Ant™  
Grand Prix™  
Lily™  
Series 7™



BEIGE MUSTARD  
413  
Ant™  
Grand Prix™  
Lily™  
Series 7™



CORN YELLOW  
443  
Ant™  
Grand Prix™  
Lily™  
Series 7™



PURPLE/YELLOW  
473  
Ant™  
Grand Prix™  
Lily™  
Series 7™



DARK PURPLE  
693  
Ant™  
Grand Prix™  
Lily™  
Series 7™



LIGHT BLUE  
733  
Ant™  
Grand Prix™  
Lily™  
Series 7™



DUSTY BLUE  
773  
Ant™  
Grand Prix™  
Lily™  
Series 7™



LIGHT EMERALD GREEN  
913  
Ant™  
Grand Prix™  
Lily™  
Series 7™



DARK EMERALD GREEN  
983  
Ant™  
Grand Prix™  
Lily™  
Series 7™

# SURFACE SELECTION

## LEATHER

Please note that leather is a natural material with natural variation in colour and surface structure. The presence of scars and marks from bites etc. on the leather may occur and are characteristics of genuine leather.

Further information about materials, care and maintenance can be found on

### CUSTOMER'S OWN LEATHER (COL)

Customers can supply their own leather. Prices excluding leather as well as leather requirements can be given on inquiry. Please note that only very few types of leather/qualities are suitable. Fritz Hansen retains the right to reject the qualities we find unsuitable.

### SPECIAL LEATHER COLOURS

On inquiry and at a surcharge, special leather colours may be available for the models available with leather upholstery.

	AURA	BUFFED	EMBRACE	ESSENTIAL	GRACE	INTENSE	NATURAL	RAW	SOFT	WILD
ANT™ FRONT			●	●	●		●		●	
CHINA CHAIR™	●		●		●		●			
DOT™		●				●				●
DROP™	●		●	●	●		●			
EGG™	●		●	●	●		●			
FRED™				●						
GRAND PRIX™ FRONT			●	●	●		●		●	
GRAND PRIX™ FULL			●	●	●		●		●	
HIGH DOT™		●				●				●
LET™				●						
LILY™			●	●	●		●		●	
LITTLE GIRAFFE™	●		●	●	●		●			
LISSONI SOFA™			●	●	●		●		●	
LUNE™	●		●						●	
MONOLIT™							●			
OKSEN™	●			●	●					
OXFORD™			●	●	●		●		●	
POT™	●		●	●	●		●			
SERIES 7™ FRONT			●	●	●		●		●	
SERIES 7™ FULL			●	●	●		●		●	
SERIES 7™ SEAT CUSHION						●		●		●
SERIES 3300™	●		●	●	●		●			
SWAN™	●		●	●	●		●			
SWAN SOFA™	●		●	●	●		●			
VICO DUO™ FRONT			●	●	●		●		●	
VICO DUO™ FULL			●	●	●		●		●	



# SURFACE SELECTION

Colours and materials may vary from the images shown.  
Actual colour, gloss level and structure may vary.

## LEATHER

### AURA



BLACK

China Chair™  
Drop™  
Egg™  
Little Giraffe™  
Lune™  
Oksen™  
Pot™  
Series 3300™  
Swan™  
Swan Sofa™

BLACK BROWN

**CATEGORY: 4**  
Chrome-tanned, top-coated, strong  
full-grain and durable surface.

Thickness 1.4-1.6 mm.

COGNAC

WALNUT

### EMBRACE

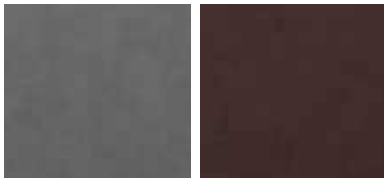

CONCRETE GREY

Ant™  
China Chair™  
Drop™  
Egg™  
Grand Prix™  
Lily™  
Little Giraffe™  
Lissoni Sofa™  
Lune™  
Oxford™  
Pot™  
Series 7™  
Series 3300™  
Swan™  
Swan Sofa™  
Vico Duo™

CHOCOLATE

**CATEGORY: 5**  
Chrome-tanned, fully grained,  
extraordinary soft aniline with a special  
waxing giving a slightly 'oily' surface.  
Colour variations, visible natural  
markings e.g. Neck wrinkles.

Thickness 1.2-1.4 mm.

### ESSENTIAL



BLACK

Ant™  
Drop™  
Egg™  
Fred™  
Grand Prix™  
Let™  
Lily™  
Little Giraffe™  
Lissoni Sofa™  
Oksen™  
Oxford™  
Pot™  
Series 7™  
Series 3300™  
Swan™  
Swan Sofa™  
Vico Duo™

WALNUT

**CATEGORY: 3**  
Chrome-tanned, lightly polished,  
top-coated and grain printed durable  
surface.

Thickness 1.0-1.2 mm.

LAVA

# SURFACE SELECTION

Colours and materials may vary from the images shown.  
Actual colour, gloss level and structure may vary.

## LEATHER

### GRACE



#### BLACK

Ant™  
China Chair™  
Drop™  
Egg™  
Grand Prix™  
Lily™  
Little Giraffe™  
Lissoni Sofa™  
Oksen™  
Oxford™  
Pot™  
Series 7™  
Series 3300™  
Swan™  
Swan Sofa™  
Vico Duo™

#### DARK BROWN

**CATEGORY: 5**  
Vegetable and chrome-tanned, aniline, full-grain with light structure and light impregnation. Becomes lighter and patinated with use, visible natural markings.

Thickness 1.2-1.4 mm.

#### WALNUT

#### CHESTNUT

### NATURAL



#### NATURAL

Ant™  
China Chair™  
Drop™  
Egg™  
Grand Prix™  
Lily™  
Little Giraffe™  
Lissoni Sofa™  
Monolit™  
Oxford™  
Pot™  
Series 7™  
Series 3300™  
Swan™  
Swan Sofa™  
Vico Duo™

**CATEGORY: 5**  
Vegetable-tanned, chrome-free, natural leather, no colour or protective finish. Becomes darker and patinated with use, visible natural markings.

Thickness 1.2-1.4 mm.

### SOFT



#### BLACK

Ant™  
Grand Prix™  
Lily™  
Lissoni Sofa™  
Little Giraffe™  
Lune™  
Oxford™  
Series 7™  
Vico Duo™

#### BLACK BROWN

**CATEGORY: 4**  
Chrome-tanned, semi-aniline, full-grain with light structure and surface finish.

Thickness 1.0-1.2 mm.

#### COGNAC

#### WALNUT

# SURFACE SELECTION

Colours and materials may vary from the images shown.  
Actual colour, gloss level and structure may vary.

## SEAT CUSHIONS

### DROP™ (3110SC)



GREY  
TEXTILE  
SALSA 3/36

BLACK  
TEXTILE  
SALSA 3/39

### NO2™ RECYCLE (NO2-70)



LIGHT GREY  
TEXTILE  
JUST 60118

DARK GREY  
TEXTILE  
JUST 60121

BLACK  
TEXTILE  
JUST 60999

### SERIES 7™ (3107SC)



WALNUT  
LEATHER  
WILD

BLACK  
LEATHER  
RAW

BROWN  
LEATHER  
INTENSE

### VICO DUO™ (VM170)

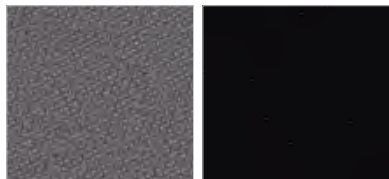

DARK GREY  
TEXTILE  
JUST 60121

BLACK  
TEXTILE  
JUST 60999

# SURFACE SELECTION

Colours and materials may vary from the images shown.  
Actual colour, gloss level and structure may vary.

## COLOURED VENEER

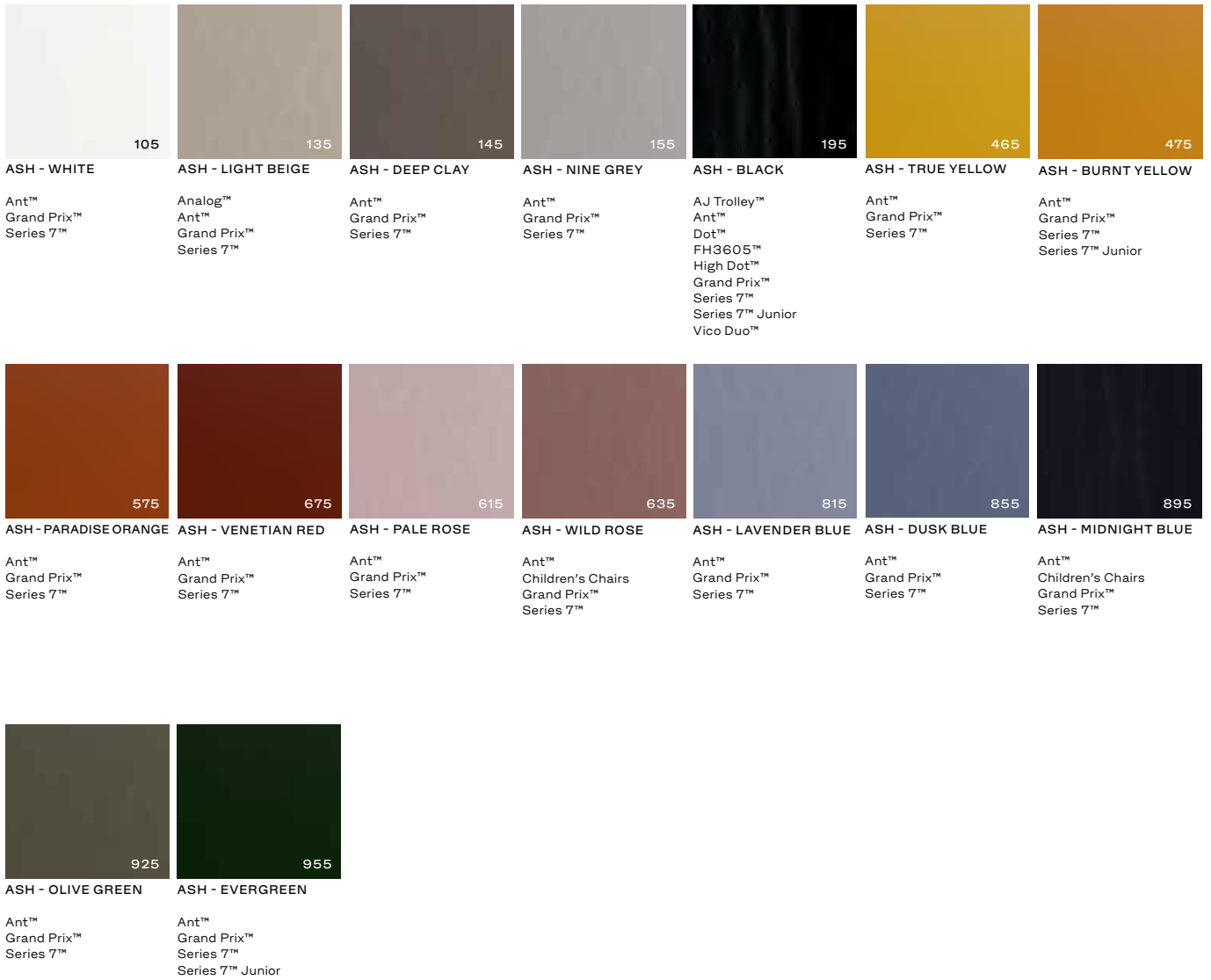

# SURFACE SELECTION

Colours and materials may vary from the images shown.  
Actual colour, gloss level and structure may vary.

## LACQUERED VENEER

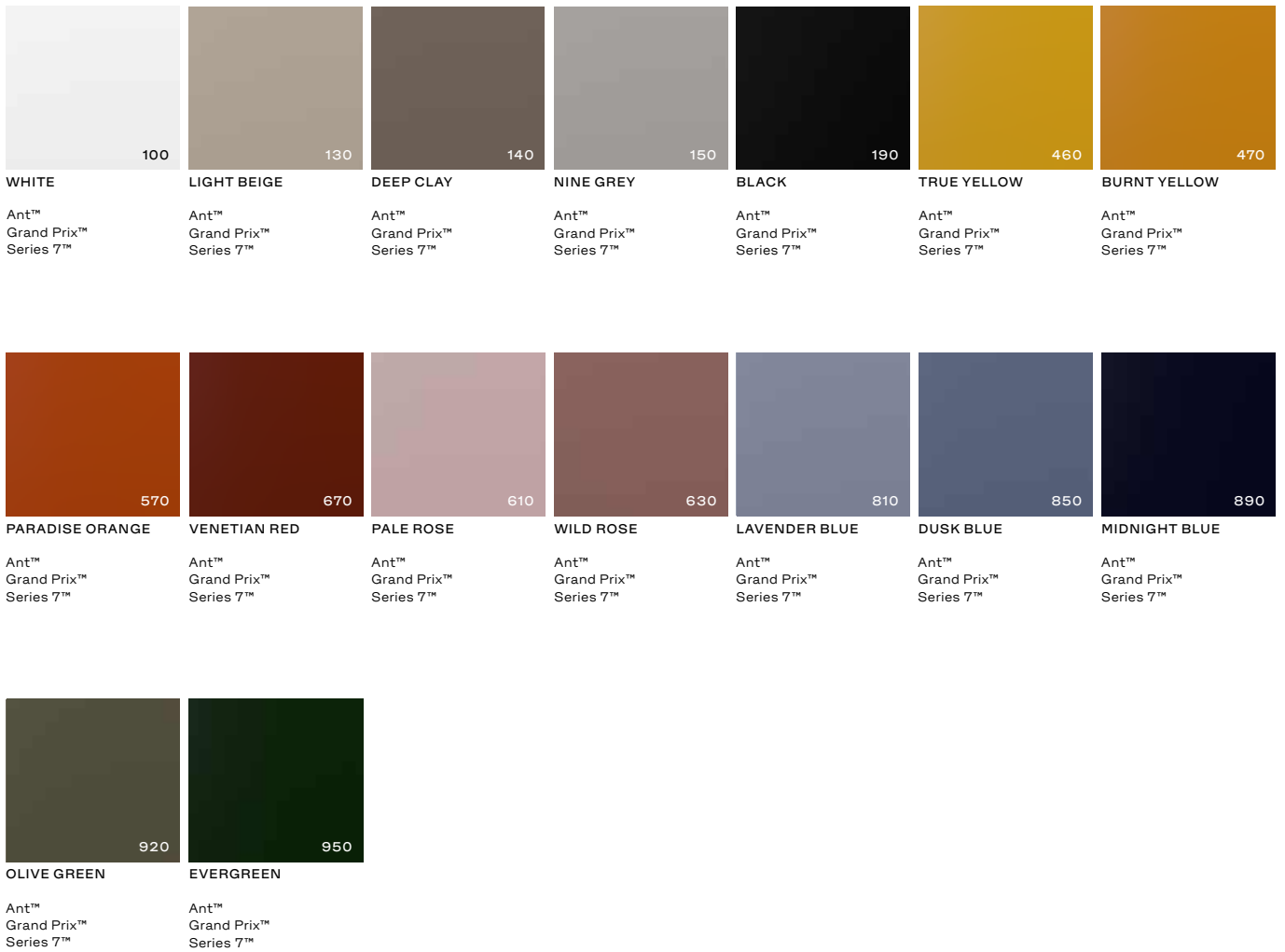

# SURFACE SELECTION

Colours and materials may vary from the images shown.  
Actual colour, gloss level and structure may vary.

## CLEAR LACQUERED VENEER

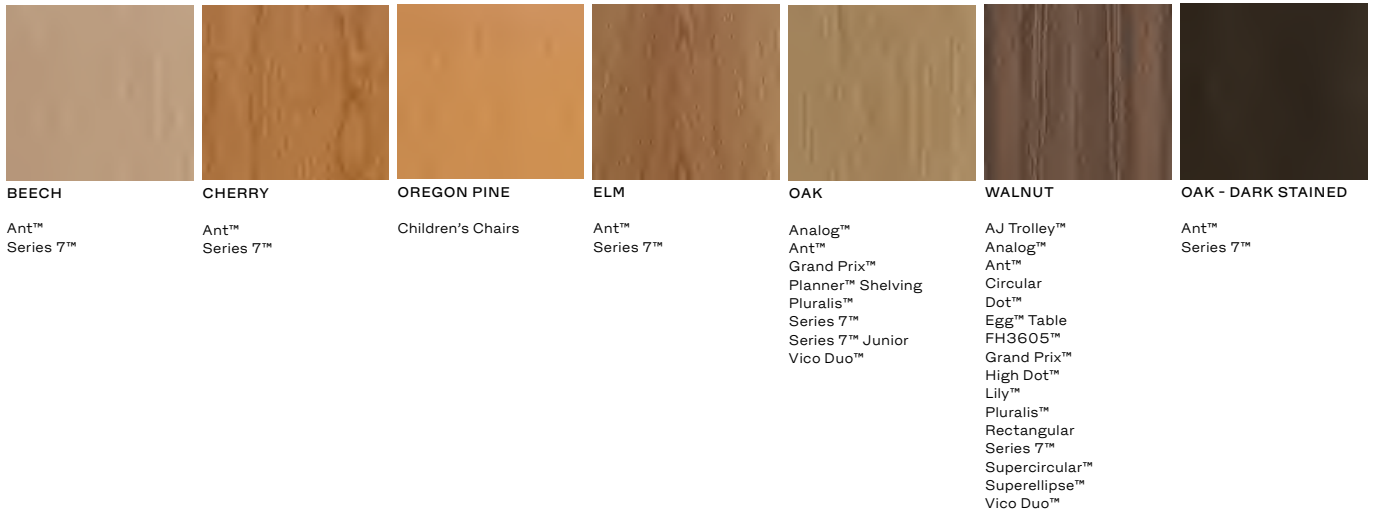

## CLEAR LACQUERED SOLID WOOD



## OILED SOLID WOOD

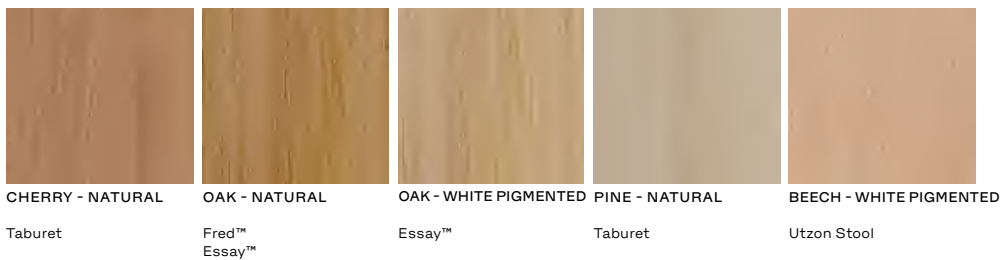

## UNTREATED SOLID WOOD

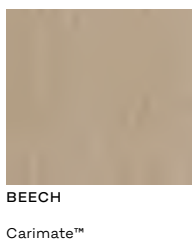

## COLOURED SOLID WOOD

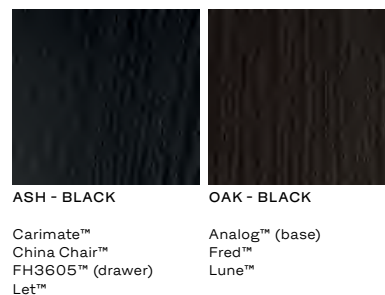

# SURFACE SELECTION

Colours and materials may vary from the images shown.  
Actual colour, gloss level and structure may vary.

## PLASTIC (ABS)

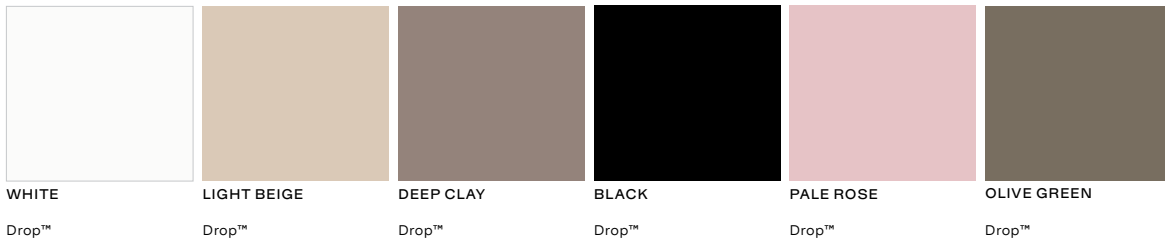

## RECYCLED PLASTIC (PP)

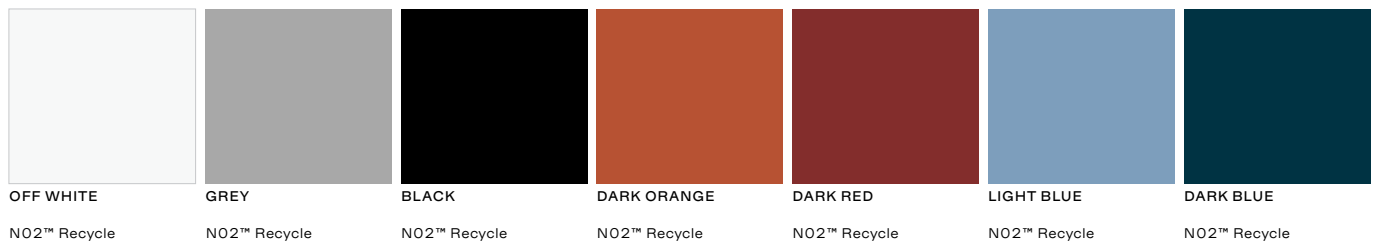

## PAPER CORD



# SURFACE SELECTION

Colours and materials may vary from the images shown.  
Actual colour, gloss level and structure may vary.

## LAMINATE (FENIX)



## LAMINATE (POLYREY)

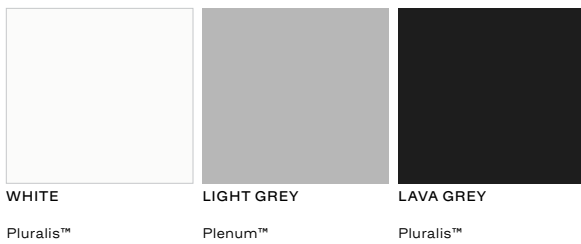

## LAMINATE (PFLEIDERER)



## COMPACT LAMINATE

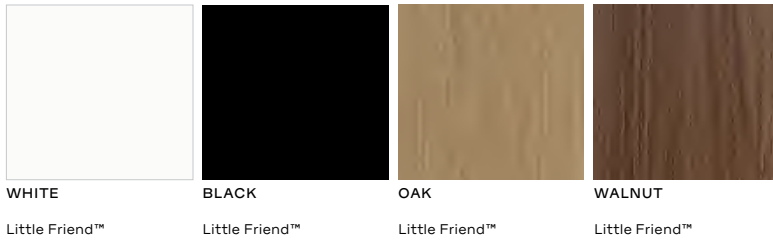

## LINOLEUM



## HONED MARBLE

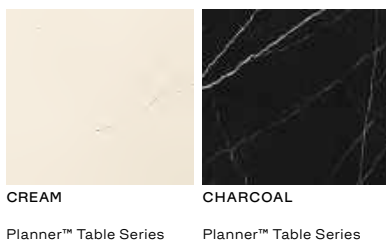



# SURFACE SELECTION

Colours and materials may vary from the images shown.  
Actual colour, gloss level and structure may vary.

## POWDER COATED METAL (STEEL OR ALUMINIUM)

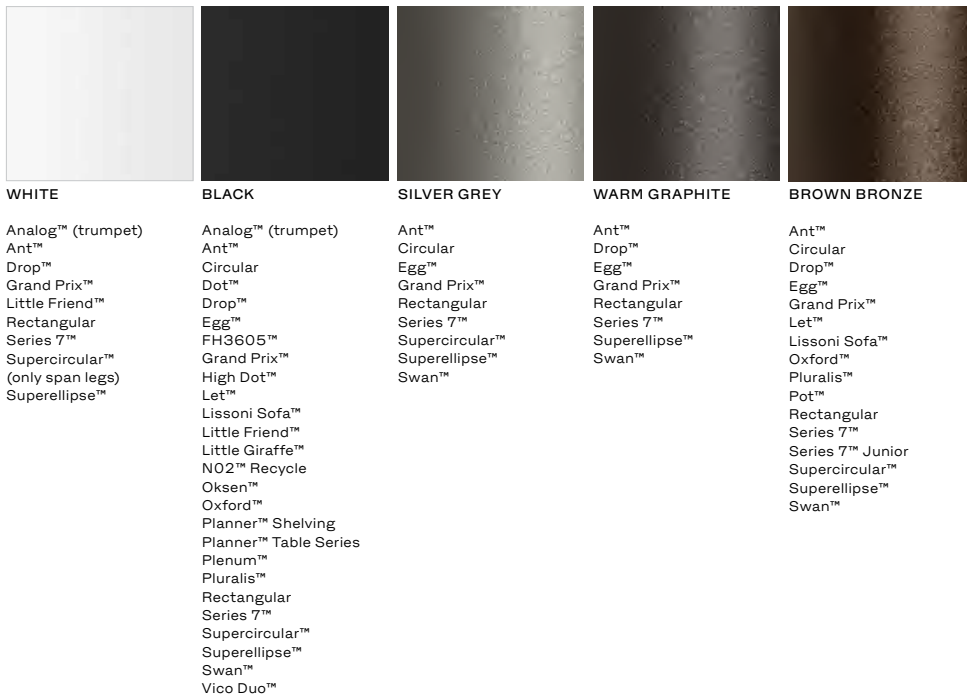
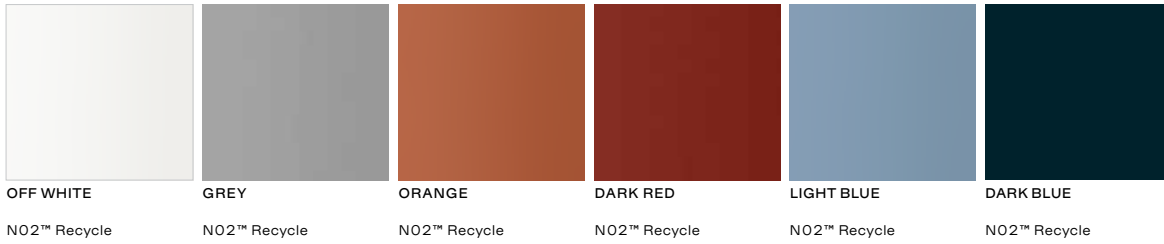

# SURFACE SELECTION

Colours and materials may vary from the images shown.  
Actual colour, gloss level and structure may vary.

## STEEL

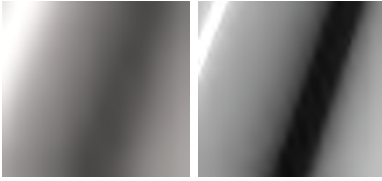

BRUSHED STAINLESS  
STEEL - MATT

Lissoni Sofa™

CHROMED STEEL  
- BRIGHT

Ant™  
Children's Chairs  
Circular  
Coat Tree™  
Dot™  
Drop™  
Egg™ Table  
FH3605™  
Grand Prix™  
High Dot™  
Let™  
Lily™  
Little Giraffe™  
N02™ Recycle  
Pot™  
Rectangular  
Series 3300™  
Series 7™  
Series 7™ Junior  
Supercircular™  
(only span legs)  
Superellipse™  
Vico Duo™

## ALUMINIUM

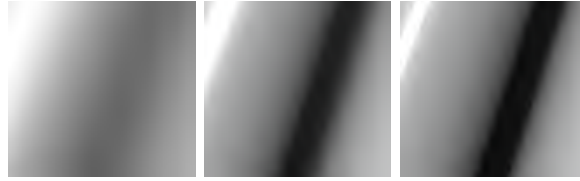

BRUSHED  
- MATT

Circular  
Egg™  
Favn™  
Fri™  
Fri™ Sofa  
Little Giraffe™  
(swivel base)  
Lune™  
Oksen™  
Oxford™  
Ro™  
Ro™ Sofa  
Swan™  
Swan Sofa™  
Supercircular™  
(only pedestal base)

POLISHED  
- BRIGHT

Little Friend™  
N02™ Recycle  
(swivel base)  
Pluralis™

CHROMED  
- BRIGHT

Oxford™

# PRICE LIST 2025

## SKAGERAK COLLECTION - OUTDOOR

EURO / VAT 21% / 01.2025

FRITZ HANSEN

# CONTENT

## 03 • GENERAL TERMS AND CONDITIONS

### OUTDOOR

- 05 • Ballare
- 06 • Banco
- 07 • Barriere
- 08 • Barriere
- 09 • Between Lines
- 10 • Columbus
- 11 • Drachmann
- 12 • Drachmann
- 13 • Drachmann
- 14 • England
- 15 • Helios
- 16 • Liliium
- 17 • Liliium
- 18 • Overlap
- 19 • Pantry
- 20 • Pelagus
- 21 • Pelagus
- 22 • Plank
- 23 • Reform
- 24 • Regatta
- 25 • Riviera
- 26 • Selandia
- 27 • Selandia
- 28 • Skagen
- 29 • Skagen
- 30 • Spider Web
- 31 • Steamer
- 32 • Tradition
- 33 • Umbrellas
- 34 • Umbrellas
- 35 • Vendia
- 36 • Virkelyst
- 37 • Virkelyst
- 38 • Carekit
- 39 • Cura

### SURFACE SELECTION

- 40 • Surface Selection

# GENERAL TERMS AND CONDITIONS

## CURRENCY & EFFECTIVE DATE

This price list is valid from 1 January 2025 and cancels all prior price lists.

Reservation is made for any errors and omissions. Furthermore, below general terms and conditions shall apply to all contracts under which Fritz Hansen A/S (Fritz Hansen) is the supplier/sub-supplier.

## ORDERING

Orders must be placed through Fritz Hansen's web-based order system called the Partner Portal ([www.fritzhansen.com](http://www.fritzhansen.com) - professional). Orders are not binding until the customer has received a written order confirmation from Fritz Hansen.

Price lists state the recommended retail price (RRP) or prices excl. VAT exclusive of freight and fees. All prices can be changed without notice. Changes to the collection such as discontinued products and/or items out of stock can occur even when stated differently in the price list. Updated information will be available on the partner portal only.

## ORDER CANCELLATION

Orders can be cancelled in accordance with the below rules:

	ORDERS CANCELLED 0-3 DAYS AFTER ORDER CONFIRMATION HAS BEEN SENT	ORDERS CANCELLED 3-14 DAYS AFTER ORDER CONFIRMATION HAS BEEN SENT
STANDARD PRODUCTS	FEE: NONE	FEE: 5% OF NET PRICE EXCL. VAT.
SPECIALS OR MODIFIED PRODUCTS	FEE: FULL PRICE	

Change and cancellation of order after 14 days from receipt of the order confirmation is not possible.

## DELIVERY

The following freight rates apply:

RATE	PER ORDER
EU+UK+NO+CH+US*	DKK 200 / € 55 / £ 50 / SEK 600 / NOK 550 / USD 55 EXCL. VAT.
REST OF THE WORLD	TO BE PICKED UP AT FRITZ HANSEN WAREHOUSES

For markets EU+UK+NO+CH+US free freight offered according to the following rates: Free shipping from DKK 3.000 / € 400 / £ 350 / SEK 4.500 / NOK 4.000 / USD 500 total order value excl. VAT.

\* For deliveries to outer areas such as islands in Portugal and Spain as well as Svalbard in Norway and others, a surcharge of DKK 420 / € 56 / £ 42 / NOK 580 per parcel will apply.

### Standard delivery terms:

- Denmark: DDP delivery address (INCO-Terms 2020)
- Countries within the EU: DDP delivery address (INCO-Terms 2020)
- European countries outside the EU: DAP delivery address (INCO-Terms 2020)
- USA: DDP delivery address (INCO-Terms 2020)
- Canada DAP delivery address (INCO-Terms 2020)
- Japan: DDP delivery address (INCO-Terms 2020)
- South Korea: DDP Fritz Hansen Busan (INCO-Terms 2020)
- Middle East, Asia, South and Central America, Australia: FCA Fritz Hansen warehouses in Denmark (INCO-Terms 2020)

For FCA: The goods must be picked up at the Fritz Hansen warehouses no later than 30 calendar days after the confirmed shipping date of the consolidated order. Address(es) for pickup will be specified on the commercial invoice. If the goods are not picked up, Fritz Hansen will charge the customer DKK 24 / € 3 / USD 4 per day per colli (all furniture orders are colli based) or pallet (all Lighting, Accessories, and Skagerak Collection orders are pallet based).

If the partner so desires, Fritz Hansen can deliver at the end user's address against an additional fee.

## CLAIMS

The physical product must be inspected upon delivery. Damage incurred in transit as well as any defects and deficiencies on the product incurred as a result of transportation must be recorded on the POD upon delivery. Fritz Hansen must be notified in writing of any claims about product defects and deficiencies within 48 hours of delivery. If the claims are made in due time and with the acceptance of Fritz Hansen, the customer is entitled to demand a replacement delivery or to have the defect remedied. The customer cannot demand a reduction or a compensation. Claims/replacements can only be made to the customer's address if delivery has not been made directly to the end user.

## TERMS OF PAYMENT

Terms of payment are 30 days net cash from invoice date. Invoices are issued and dated when the goods are dispatched. In case of late payment, interest will be charged at a rate of 1.5 % for every month or part thereof as from the due date. Interest invoices are payable net cash within eight days. Fritz Hansen can decide that the customer shall pay in advance, if the customer's balance is or has previously been due, or if the order amount exceeds the credit limit approved by Fritz Hansen.

## OBSERVATION OF TITLE

Title to the goods shall not pass to the customer until Fritz Hansen (or any third party to whom Fritz Hansen has assigned its rights to the purchase price) has received the full purchase price and been reimbursed any expenses incurred.

## WARRANTY

Fritz Hansen provides a standard five-year warranty on standard products within the collections Furniture and Skagerak Collection (Indoor & Outdoor) against defects in materials and workmanship. For the Arne Jacobsen shell chairs (Ant™, Grand Prix™, Lily™, Series 7™), the standard warranty is 10 years. Within the Furniture collection, an extended warranty of up to 10 years is provided on selected products, provided they have been registered online on [www.fritzhansen.com/my-fh](http://www.fritzhansen.com/my-fh) (see table on the next page for details).

Exception exists for AJ Children's Chairs, Series 7™ Junior, Series 7™ Cushion, Coat Tree™ Wall, Dot™, High Dot™ and AJ Trolley™ which are included in the Accessories warranty terms.

For the Poul Kjærholm collection, the standard warranty is 20 years except for PK0 A™ and PK60™, which is 10 years, and the PK15™, which is 5 years. Wicker and French Cane have a warranty of 2 years.

For the Lighting, Accessories and Skagerak Collection Accessories the standard warranty is 2 years. Specific for the Lighting category: Transformers, ballasts, light sources, and other electronic devices are subject to the warranty terms of the manufacturer in question. Fritz Hansen does not cover costs related to installation and dismantling, replacement of ballasts/transformers and other similar costs related to electricians and the like.

The warranty on all collections does not extend to ordinary tear, wear or damage to upholstery. On any material, textile, or leather which is not listed in our price lists configured on a specific product, the standard warranty is 2 years. The warranty is void upon subsequent changes to the product.

Additional warranty conditions can be found on [www.fritzhansen.com](http://www.fritzhansen.com).

## LIMITATION OF LIABILITY

Fritz Hansen will assume no liability for any loss as a result of delays, defects or any other breach of contract, unless such loss was caused by gross negligence on the part of Fritz Hansen. Fritz Hansen will assume no liability for any indirect loss, including loss of profits, operating loss, goodwill, loss of customers, running costs or any other consequential economic loss.

## CHOICE OF LAW AND JURISDICTION

Disputes between Fritz Hansen and its customers shall be subject to Danish law, except for the international civil law rules of Danish law, and shall be settled by Fritz Hansen's home court.

## MEASUREMENTS

The stated measurements act only as a guideline. The measurements can vary, and size difference on a product can occur.

## FORCE MAJURE

Fritz Hansen is without liability for non-performance of Fritz Hansen's obligations in respect to any orders received, if such non-performance is due to circumstances out of Fritz Hansen's reasonable control, which prevent the fulfilment of the purchase agreement or makes the fulfilment unreasonably burdensome. As examples of such circumstances the following can be mentioned: Industrial dispute and other circumstances which are beyond the control of the parties, such as fire, war, mobilization or calling in for military service of similar extent, requisition, seizure, exchange

controls, riots or disturbances, shortage of means of transportation, ordinary scarcity of goods, restrictions of motive power and defects in or late performance from sub-suppliers due to any of the aforementioned circumstances.

The above circumstances only lead to exemption from liability if their influence on the fulfilment of the purchase agreement could not be anticipated at the conclusion of the agreement. Fritz Hansen must without undue delay notify the customer in writing if any such circumstances, occurrence and cessation, if Fritz Hansen wishes to invoke any grounds of exemption from liability.

Regardless of what follows from these general conditions of sales and delivery, any party is entitled to terminate the purchase agreement by notifying the other party in writing, if the fulfilment of the agreement is prevented for more than 6 months due to one of the above circumstances.

Unless mandatory rules preclude this, Fritz Hansen is in no case liable to the customer for operating losses, lost earnings, or other financial consequential damages under these general conditions for sale and delivery.

## PRIVACY POLICY

At Fritz Hansen, confidentiality and data protection is a high priority. Guidelines for processing of personal data and description of the customer's and end users' rights according to applicable data protection law is governed by Fritz Hansen's privacy policy available on Fritz Hansen's website.

# WARRANTY OVERVIEW

Price list collections	Furniture Collection						Poul Kjærholm Collection				Skagerak Collection		Lighting Collection	Accessories Collection					
	Textiles, Cushions	Leather (1)	Leather (2)	Bases (3)	Bases (4)	Movable parts (5)	Ant <sup>™</sup> Grand Prix <sup>™</sup> , Lily <sup>™</sup> , Series 7 <sup>™</sup>	Shells, Tabletops	Tabletops (6)	China Chair <sup>™</sup>	French Cane, Wicker	PK15 <sup>™</sup>	PKO A <sup>™</sup> & PK60 <sup>™</sup>	Poul Kjærholm Collection	Outdoor	Indoor	Lighting	Accessories	Skagerak Collection
2 years										x							x	x	x
5 years	x	x		x		x					x			x	x				
10 years			x*		x*		x	x*				x**							
20 years									x**				x**						

1. Leather: Soft and Essential
2. Leather: Aura, Rustik, Natural, Grace and Embrace
3. Bases: Lacquered and Wooden (chairs), Powder coated (chairs and tables)
4. Bases: Aluminium, Chrome and Wooden (tables)
5. Movable parts: Automatic return, Tilt, Height-adjustable, Swivel, Castors and Extension mechanism
6. Tabletops: Lacquer under tabletop, Lacquer on edges and Surface on tabletop

\* Additional with registration on [www.fritzhansen.com/my-fh](http://www.fritzhansen.com/my-fh)

\*\* Standard without registration



The Ballare series of elegant outdoor furniture is crafted for lasting beauty. Blurring the lines between indoor and outdoor living, the minimalist designs feature soft curves and considered details that make them a delight to look at as well as to use. Designed by Danish designer Jakob Berg.

**CHAIRS**

ITEM NO.	DESCRIPTION	EXCL. VAT	INCL. VAT
S1505100	Ballare chair, seat height 45,5 cm, teak FSC 100%, stackable (max 4 pcs)	635	769

**TABLES**

ITEM NO.	DESCRIPTION	EXCL. VAT	INCL. VAT
S1505200	Ballare table, table height 73 cm, teak FSC 100%, incl. 2 extension plates, length incl. extension 246/295 cm	3.222	3.899

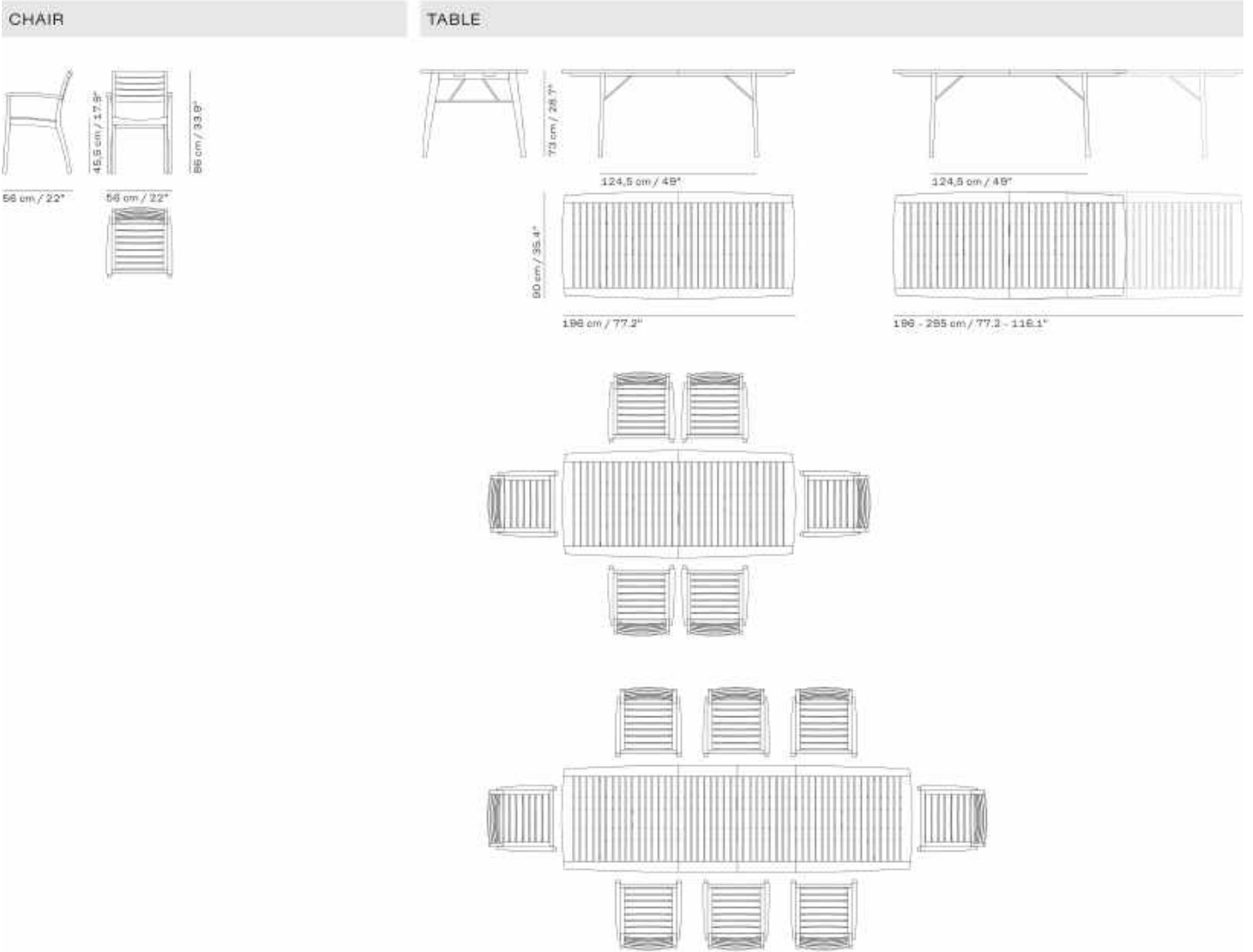



Originally designed for an outdoor exhibition in Finland called Social Seating, the Banco Bench by Portuguese designer Hugo Passos derives beauty from the simple premise of creating something that enhances the experience of nature.

**BENCHES**

ITEM NO.	DESCRIPTION	EXCL. VAT	INCL. VAT
1506150	Banco bench, seat height 45 cm, teak FSC 100%	1.280	1.549
1506140	Banco bench double, seat height 45 cm, teak FSC 100%	2.230	2.699

**BENCH**

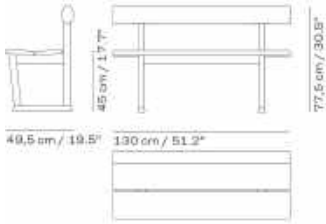

**BENCH DOUBLE**

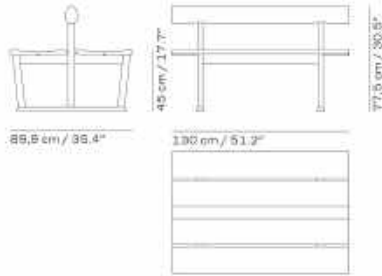



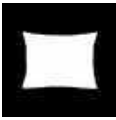

The Barriere series is a range of beautiful cushions designed to make seating experiences better and softer. Designed for all weather conditions, the cushions are made to last year after year with resilient and weatherproof materials.

**SEAT CUSHIONS 43X43**

ITEM NO.	DESCRIPTION	EXCL. VAT	INCL. VAT
1960856	Barriere cushion, 43x43 cm, charcoal	57	69
1960857	Barriere cushion, 43x43 cm, ash	57	69
1960858	Barriere cushion, 43x43 cm, white	57	69
1960859	Barriere cushion, 43x43 cm, marine	57	69
1961170	Barriere cushion 43x43 cm, golden yellow stripe	57	69

**SEAT CUSHIONS 55X43**

ITEM NO.	DESCRIPTION	EXCL. VAT	INCL. VAT
1970580	Barriere cushion 55x43 cm, golden yellow stripe	73	89
1970581	Barriere cushion 55x43 cm, charcoal	73	89
1970582	Barriere cushion 55x43 cm, ash	73	89
1970583	Barriere cushion 55x43 cm, marine	73	89
1970584	Barriere cushion 55x43 cm, white	73	89

**SEAT CUSHIONS 125X43**

ITEM NO.	DESCRIPTION	EXCL. VAT	INCL. VAT
1960967	Barriere cushion 125x43 cm, golden yellow stripe	156	189
1961008	Barriere cushion 125x43 cm, ash	156	189
1961009	Barriere cushion 125x43 cm, charcoal	156	189

**DECK CHAIR CUSHIONS**

ITEM NO.	DESCRIPTION	EXCL. VAT	INCL. VAT
1960852	Barriere deck chair cushion, charcoal	288	349
1960853	Barriere deck chair cushion, ash	288	349
1961271	Barriere deck chair cushion, cloud white	288	349
1960855	Barriere deck chair cushion, marine	288	349
1961052	Barriere deck chair cushion, golden yellow stripe	288	349
1961152	Barriere deck chair cushion, papyrus	354	429



**DECK CHAIR CUSHION**

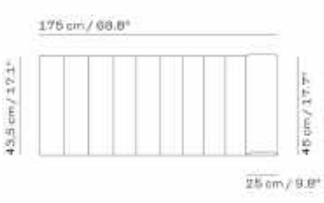



**DECORATIVE PILLOWS 50X40**

ITEM NO.	DESCRIPTION	EXCL. VAT	INCL. VAT
1960965	Barriere pillow 50x40 cm, golden yellow stripe	77	94
1961187	Barriere pillow 50x40 cm, light apricot/dark green	98	119
1961188	Barriere pillow 50x40 cm, lemon/sand stripe	98	119
1961257	Barriere pillow 50x40 cm, honey yellow	114	139
1970593	Barriere pillow 50x40 cm, papyrus	114	139

**DECORATIVE PILLOWS 60X50**

ITEM NO.	DESCRIPTION	EXCL. VAT	INCL. VAT
1961239	Barriere pillow 60x50 cm, light apricot/dark green stripe	114	139
1961243	Barriere pillow 60x50 cm, lemon/sand stripe	114	139
1961247	Barriere pillow 60x50 cm, golden yellow stripe	98	119
1961254	Barriere pillow 60x50 cm, honey yellow	123	149
1970597	Barriere pillow 60x50 cm, papyrus	123	149

**DECORATIVE PILLOW 50X40**

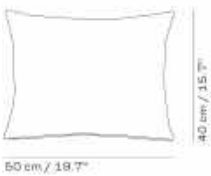

**DECORATIVE PILLOW 60X50**





Made with comfort, quality and durability in mind, the Between Lines series has a restful expression which makes it perfect for enjoying life slowly in the great outdoors. Designed by Danish furniture designer Stine Weigelt.

**DECK CHAIRS**

ITEM NO.	DESCRIPTION	EXCL. VAT	INCL. VAT
1550605	Between Lines deck chair, seat height 28 cm, teak FSC 100%	767	929

**CUSHIONS DECK CHAIRS**

ITEM NO.	DESCRIPTION	EXCL. VAT	INCL. VAT
1960660	Between Lines deck chair cushion, charcoal	362	439
1960869	Between Lines deck chair cushion, ash	362	439
1961159	Between Lines deck chair cushion, papyrus	453	549
1961161	Between Lines deck chair cushion, lemon/sand stripe	404	489

**STOOLS**

ITEM NO.	DESCRIPTION	EXCL. VAT	INCL. VAT
1550615	Between Lines deck stool, seat height 28 cm, teak FSC 100%	346	419

**DECK CHAIR**

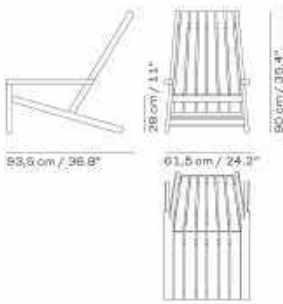

**CUSHION DECK CHAIR**



**STOOL**





## COLUMBUS SKAGERAK DESIGN

01.2025

The Columbus Series takes its design cues from traditional American-style garden chairs. Pared back to a simpler, Scandinavian expression with slatted seats and visible fittings, the series is equally suited to al fresco dining and or relaxing on a sunny terrace or balcony.

### SUNBEDS

ITEM NO.	DESCRIPTION	EXCL. VAT	INCL. VAT
S1390650	Columbus sunbed w/black suntexture, teak FSC 100%, reclining backrest	1.280	1.549
S1390655	Columbus sunbed w/white suntexture, teak FSC 100%, reclining backrest	1.280	1.549

### SUNBED

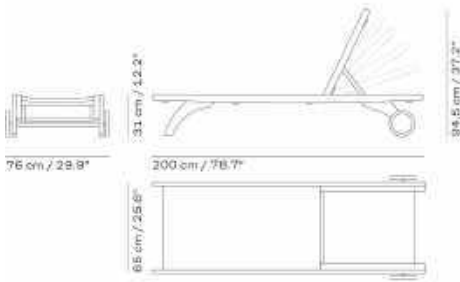



The signature Drachmann series draws inspiration from the beautiful garden of Danish romantic poet and painter, Holger Drachmann. A careful balance of Nordic nostalgia and modern simplicity underlies its enduring popularity.

#### CHAIRS

ITEM NO.	DESCRIPTION	EXCL. VAT	INCL. VAT
S1040520	Drachmann chair, seat height 44 cm, teak FSC 100%	701	849

#### CUSHIONS CHAIRS

ITEM NO.	DESCRIPTION	EXCL. VAT	INCL. VAT
1960220	Drachmann chair cushion, lemon/sand stripe	205	249
1960221	Drachmann chair cushion, light apricot/dark green stripe	205	249
1960228	Drachmann chair cushion, papyrus	222	269
1960800	Drachmann chair cushion, charcoal	180	219
1960801	Drachmann chair cushion, ash	180	219
1960803	Drachmann chair cushion, marine	180	219

#### BENCHES

ITEM NO.	DESCRIPTION	EXCL. VAT	INCL. VAT
S1040505	Drachmann bench 120 cm, seat height 44 cm, teak FSC 100%	1.280	1.549
S1040510	Drachmann bench 165 cm, seat height 44 cm, teak FSC 100%	1.528	1.849
S1040515	Drachmann bench 200 cm, seat height 44 cm, teak FSC 100%	1.817	2.199

#### CUSHIONS BENCHES

ITEM NO.	DESCRIPTION	EXCL. VAT	INCL. VAT
1960222	Drachmann cushion 120 cm, lemon/sand stripe	321	389
1960223	Drachmann cushion 120 cm, light apricot/dark green stripe	321	389
1960229	Drachmann cushion 120 cm, papyrus	362	439
1960804	Drachmann cushion 120 cm, charcoal	288	349
1960805	Drachmann cushion 120 cm, ash	288	349
1960807	Drachmann cushion 120 cm, marine	288	349
1960224	Drachmann cushion 165 cm, lemon/sand stripe	379	459
1960225	Drachmann cushion 165 cm, light apricot/dark green stripe	379	459
1960230	Drachmann cushion 165 cm, papyrus	486	589
1960808	Drachmann cushion 165 cm, charcoal	346	419
1960809	Drachmann cushion 165 cm, ash	346	419
1960811	Drachmann cushion 165 cm, marine	346	419
1960226	Drachmann cushion 200 cm, lemon/sand stripe	453	549
1960227	Drachmann cushion 200 cm, light apricot/dark green stripe	453	549
1960231	Drachmann cushion 200 cm, papyrus	594	719
1960812	Drachmann cushion 200 cm, charcoal	379	459
1960813	Drachmann cushion 200 cm, ash	379	459
1960815	Drachmann cushion 200 cm, marine	379	459

#### TABLES

ITEM NO.	DESCRIPTION	EXCL. VAT	INCL. VAT
S1042005	Drachmann table Ø126, table height 72 cm, teak FSC 100%, hole in middle for parasol	1.817	2.199
S1042010	Drachmann table 86 cm, table height 72 cm, teak FSC 100%, hole in middle for parasol	990	1.199
S1042015	Drachmann table 156 cm, table height 72 cm, teak FSC 100%, hole in middle for parasol	1.486	1.799
S1042020	Drachmann table 190 cm, table height 72 cm, teak FSC 100%, hole in middle for parasol	2.065	2.499



CHAIR

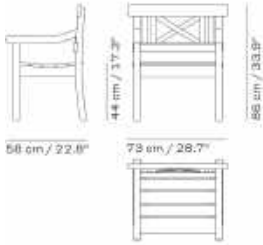

CUSHION CHAIR



BENCH 120

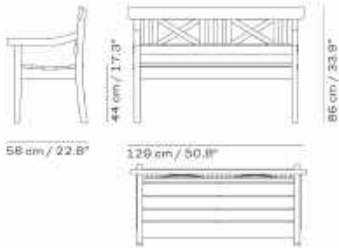

CUSHION BENCH 120



BENCH 165

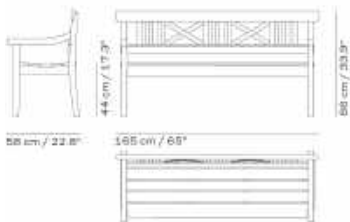

CUSHION BENCH 165



BENCH 200

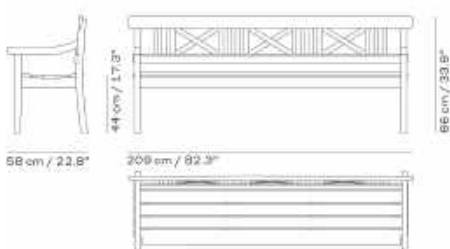

CUSHION BENCH 200





TABLE Ø126

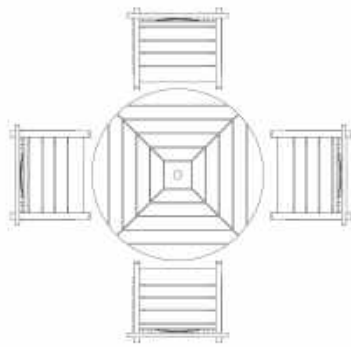
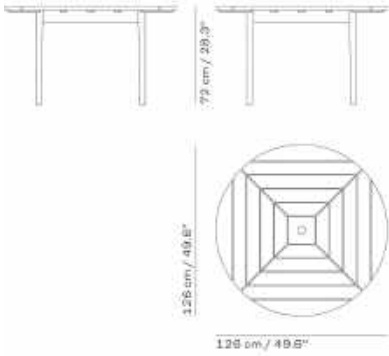

TABLE 86

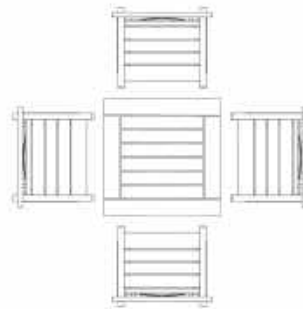

TABLE 156

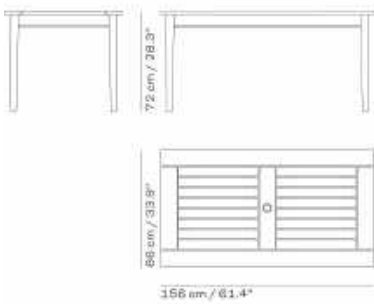
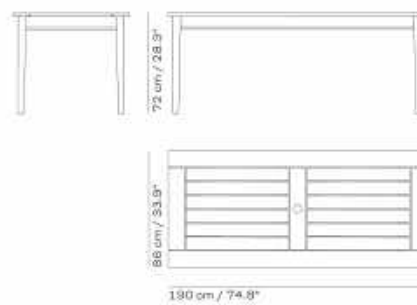

TABLE 190





Looking to the wooden benches found in parks and gardens across Britain, the England Series is a modern interpretation of a classic design, complete with comfortable contours and a sturdy and durable construction. Crafted in 100% FSC-certified teak.

ITEM NO.	DESCRIPTION	EXCL. VAT	INCL. VAT
S1350505	England bench 152 cm, seat height 44 cm, teak FSC 100%	1.528	1.849
S1350510	England bench 180 cm, seat height 44 cm, teak FSC 100%	1.734	2.099

**BENCH 152**

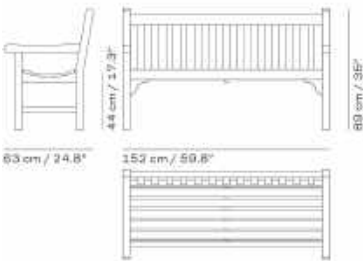

**BENCH 180**

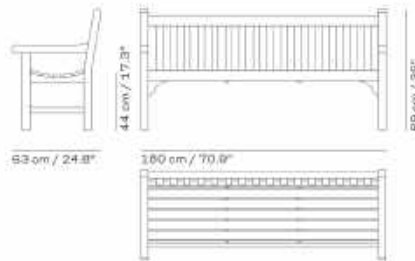





## HELIOS SKAGERAK DESIGN

01.2025

The free-standing Helios Fire Bowl offers comforting warmth all year round—and a focal point for outdoor gatherings. Cast in iron with handle inserts that make it easy to move when not in use. A removable ash tray underneath ensures the area stays clean.

### GARDEN

ITEM NO.	DESCRIPTION	EXCL. VAT	INCL. VAT
S1810512	Helios firebowl, cast iron, side handles for easy move	362	439

### FIREBOWL





## LILIUM BIG - BJARKE INGELS GROUP

01.2025

The Lilium series is a contemporary take on outdoor furniture inspired by the shape of a lily pad. Designed by the renowned BIG – Bjarke Ingels Group – Lilium is long-lasting furniture, crafted in teak and stainless steel, ideal for outdoor events and gatherings for years to come.

### CHAIRS

ITEM NO.	DESCRIPTION	EXCL. VAT	INCL. VAT
1420074	Lilium chair, seat height 45 cm, teak FSC 100%, stainless steel frame	577	699
1420075	Lilium armchair, seat height 45 cm, teak FSC 100%, stainless steel frame	635	769
1420070	Lilium lounge chair, seat height 37 cm, teak FSC 100%/stainless steel	990	1.199

### CUSHIONS CHAIRS

ITEM NO.	DESCRIPTION	EXCL. VAT	INCL. VAT
1961015	Lilium chair cushion, ash	139	169
1961016	Lilium chair cushion, white	139	169
1961017	Lilium chair cushion, marine	139	169
1961031	Lilium chair cushion, charcoal	139	169
1961153	Lilium chair cushion, papyrus	139	169
1961012	Lilium lounge chair cushions, ash	205	249
1961013	Lilium lounge chair cushions, white	205	249
1961014	Lilium lounge chair cushions, marine	205	249
1961030	Lilium lounge chair cushions, charcoal	205	249
1961157	Lilium lounge chair cushion, papyrus	205	249

### BENCHES

ITEM NO.	DESCRIPTION	EXCL. VAT	INCL. VAT
1420072	Lilium bench, seat height 45 cm, teak FSC 100%, stainless steel frame	908	1.099

### CUSHIONS BENCHES

ITEM NO.	DESCRIPTION	EXCL. VAT	INCL. VAT
1961019	Lilium bench cushion, ash	205	249
1961020	Lilium bench cushion, white	205	249
1961021	Lilium bench cushion, marine	205	249
1961155	Lilium bench cushion, papyrus	205	249
1961018	Lilium bench cushion, charcoal	205	249

### TABLES

ITEM NO.	DESCRIPTION	EXCL. VAT	INCL. VAT
1420073	Lilium table 160, table height 73 cm, teak FSC 100%, stainless steel frame	1.404	1.699
1420071	Lilium lounge table, table height 50 cm, teak FSC 100%, stainless steel frame	635	769



CHAIR



ARMCHAIR



LOUNGE CHAIR

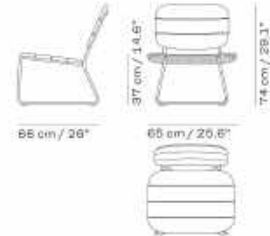

CUSHION CHAIR

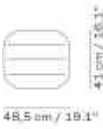

CUSHION LOUNGE CHAIR

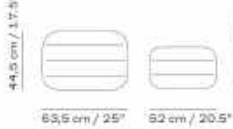

BENCH

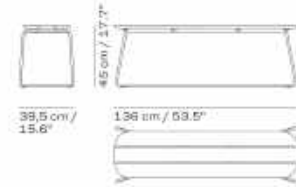

CUSHION BENCH

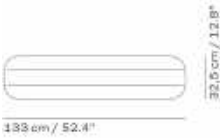

TABLE

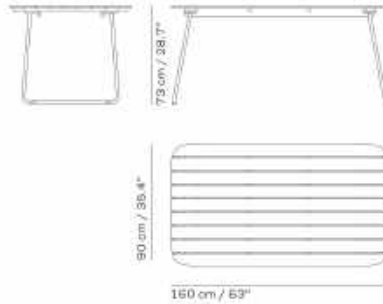

LOUNGE TABLE

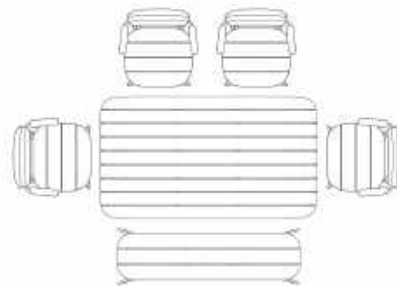
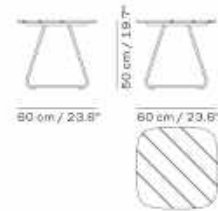



**OVERLAP**  
TAF

Overlap series stands strong on its overlapping steel legs. Thanks to the rustic wooden planks and the powder-coated steel, the collection has a modern edge and contemporary appeal. Perfect for both indoor and outdoor use. Overlap is designed in collaboration with Swedish architecture studio, TAF.

**BENCHES**

ITEM NO.	DESCRIPTION	EXCL. VAT	INCL. VAT
1392012	Overlap bench, seat height 43 cm, hunter green, western red cedar/powder coated steel	1.238	1.499
1392013	Overlap bench, seat height 43 cm, anthracite black, western red cedar/powder coated steel	1.238	1.499

**TABLES**

ITEM NO.	DESCRIPTION	EXCL. VAT	INCL. VAT
1392002	Overlap table, table height 73 cm, hunter green, western red cedar/powder coated steel	3.222	3.899
1392003	Overlap table, table height 73 cm, anthracite black, western red cedar/powder coated steel	3.222	3.899

**BENCH**



**TABLE**

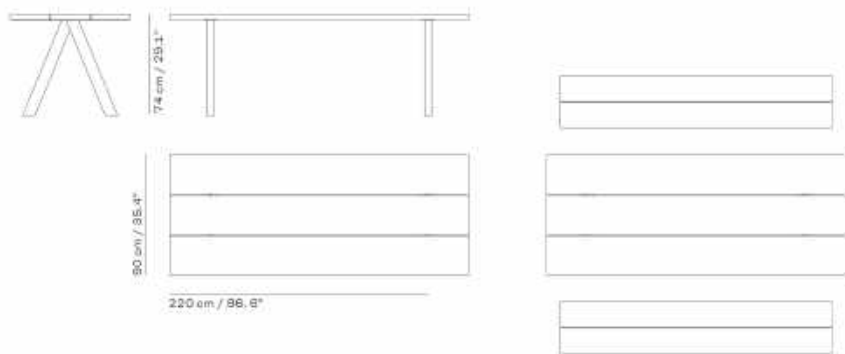



**PANTRY**  
MARIA ZACHARIAE

01.2025

The Pantry series of freestanding shelving units offers versatile storage solutions for indoor and outdoor living. The portable designs in durable FSC-certified teak feature easy-clean, natural limestone tops and slatted shelves that offer extra surface space whether cooking, potting plants or simply storing useful items close to hand.

ITEM NO.	DESCRIPTION	EXCL. VAT	INCL. VAT
1600811	Pantry module 1, table height 92,5 cm, limestone/teak FSC 100%	1.528	1.849
1600821	Pantry module 2, table height 92,5 cm, limestone/ teak FSC 100%	2.313	2.799

**MODULE 1**

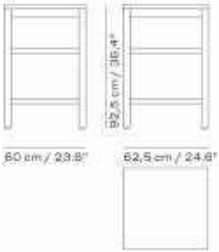

**MODULE 2**

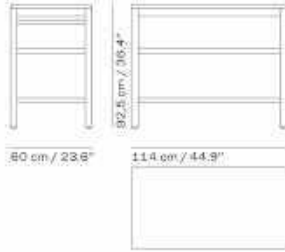



Pelagus has a graceful contemporary expression that sits lightly in nature and holds its own in urban environments. The collection is high on comfort and versatility. It is furniture that suits a lifestyle as diverse as that lived in urban cosmopolitans or far from the city and grounded in nature. Designed in collaboration with Stockholm-based Note Design Studio.

#### CHAIRS

ITEM NO.	DESCRIPTION	EXCL. VAT	INCL. VAT
1430054	Pelagus chair, seat height 45 cm, light Ivory, teak FSC 100%/powder coated aluminum, stackable (max 5 pcs)	635	769
1430059	Pelagus chair, seat height 45 cm, hunter green, teak FSC 100%/powder coated aluminum, stackable (max 5 pcs)	635	769
1430056	Pelagus armchair, seat height 45 cm, light Ivory, teak FSC 100%/powder coated aluminum, stackable (max 2 pcs)	767	929
1430060	Pelagus armchair, seat height 45 cm, hunter green, teak FSC 100%/powder coated aluminum, stackable (max 2 pcs)	767	929
1430050	Pelagus lounge chair, seat height 38 cm, teak FSC 100%/powder coated aluminum	1.404	1.699

#### CUSHIONS CHAIRS

ITEM NO.	DESCRIPTION	EXCL. VAT	INCL. VAT
1961055	Pelagus chair cushion, honey yellow	189	229
1961102	Pelagus chair cushion, charcoal	147	179
1961105	Pelagus chair cushion, ash	147	179
1961054	Pelagus lounge chair cushion, honey yellow	379	459
1961104	Pelagus lounge chair cushion, charcoal	304	369
1961107	Pelagus lounge chair cushion, ash	304	369

#### TABLES

ITEM NO.	DESCRIPTION	EXCL. VAT	INCL. VAT
1430053	Pelagus table, table height 74 cm, light Ivory, teak FSC 100%/powder coated aluminum	3.222	3.899
1430058	Pelagus table, table height 74 cm, hunter green, teak FSC 100%/powder coated aluminum, can be extended (extension plates sold seperately)	3.222	3.899
1430062	Pelagus extension plate, teak FSC 100%, 1 pcs, can be stored on the frame underneath the tabletop	511	619

#### SUNBEDS

ITEM NO.	DESCRIPTION	EXCL. VAT	INCL. VAT
1430055	Pelagus sunbed, teak FSC 100%, powder coated aluminum	2.230	2.699
1430061	Pelagus sunbed armrest, teak FSC 100%, 1 pcs	156	189

#### CUSHIONS SUNBEDS

ITEM NO.	DESCRIPTION	EXCL. VAT	INCL. VAT
1961056	Pelagus sunbed cushion, honey yellow	635	769
1961103	Pelagus sunbed cushion, charcoal	544	659
1961106	Pelagus sunbed cushion, ash	544	659



CHAIR

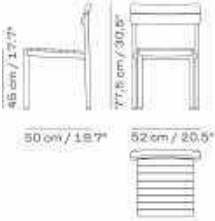

ARMCHAIR



LOUNGE CHAIR

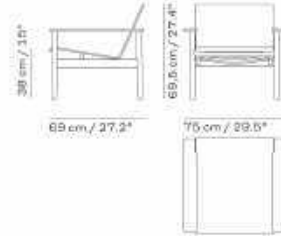

CUSHION CHAIR

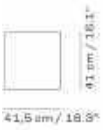

CUSHION LOUNGE CHAIR



EXTENSION PLATE



TABLE

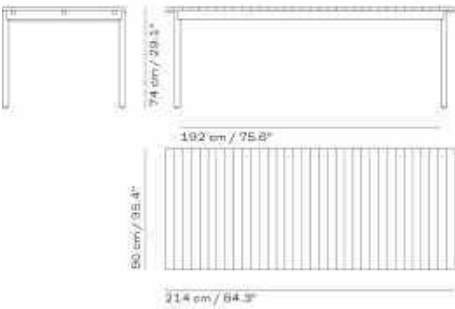

SUNBED

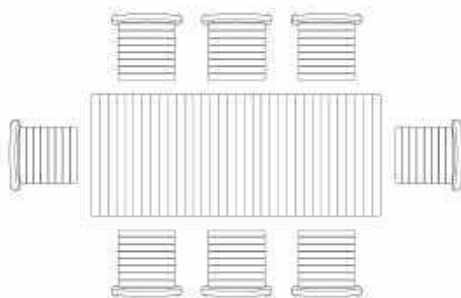
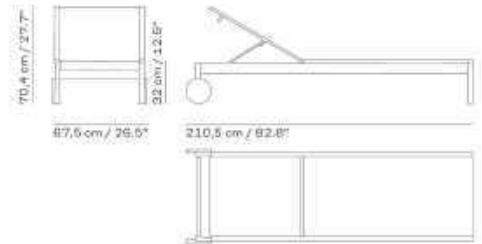

SUNBED ARMREST

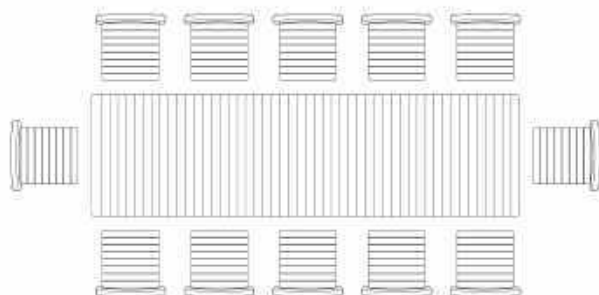

CUSHION SUNBED

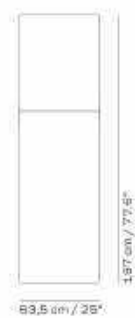



Plank outdoor series by contemporary Parisian designer Aurélien Barbry, is characterised by simplicity and functional beauty. An architectural repetition lends the Plank series a clean and modern elegance.

**CHAIRS**

ITEM NO.	DESCRIPTION	EXCL. VAT	INCL. VAT
1350601	Plank chair, seat height 45 cm, teak FSC 100%	635	769

**BENCHES**

ITEM NO.	DESCRIPTION	EXCL. VAT	INCL. VAT
1350600	Plank bench 144, seat height 45 cm, teak FSC 100%	1.404	1.699

**TABLES**

ITEM NO.	DESCRIPTION	EXCL. VAT	INCL. VAT
1350602	Plank table 160x90, table height 73 cm, teak FSC 100%	1.528	1.849

**CHAIR**

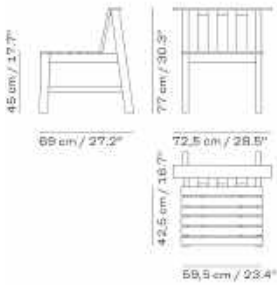

**BENCH**

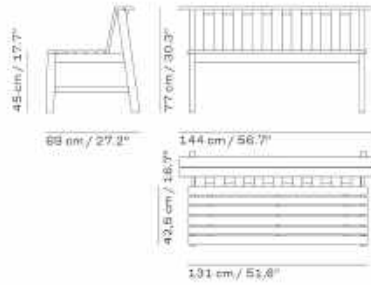

**TABLE**

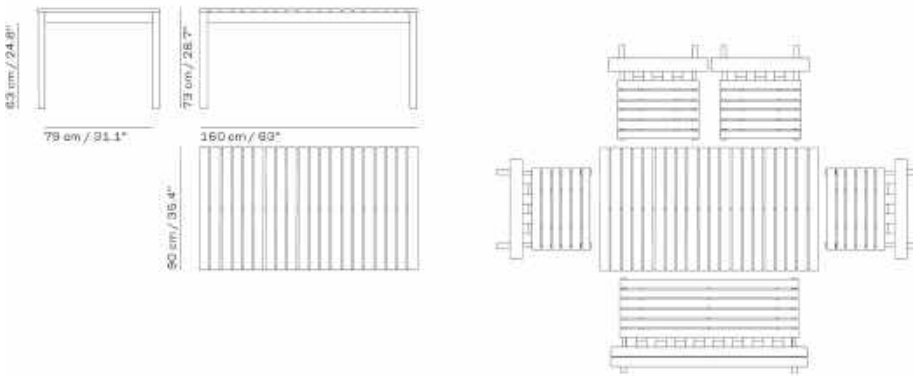





Reform series is known for its classic yet modern look – made in a combination of aluminium and untreated teak. Designed in collaboration with Swedish designer Louise Hederström.

**BENCHES**

ITEM NO.	DESCRIPTION	EXCL. VAT	INCL. VAT
1560026	Reform bench 110, seat height 43,5 cm, hunter green, teak FSC 100%	792	959
1560027	Reform bench 110, seat height 43,5 cm, anthracite black, teak FSC 100%	792	959

**TABLES**

ITEM NO.	DESCRIPTION	EXCL. VAT	INCL. VAT
1560040	Reform table 125, table height 73 cm, hunter green, teak FSC 100%	1.280	1.549
1560041	Reform table 125, anthracite black, table height 73 cm, teak FSC 100%	1.280	1.549

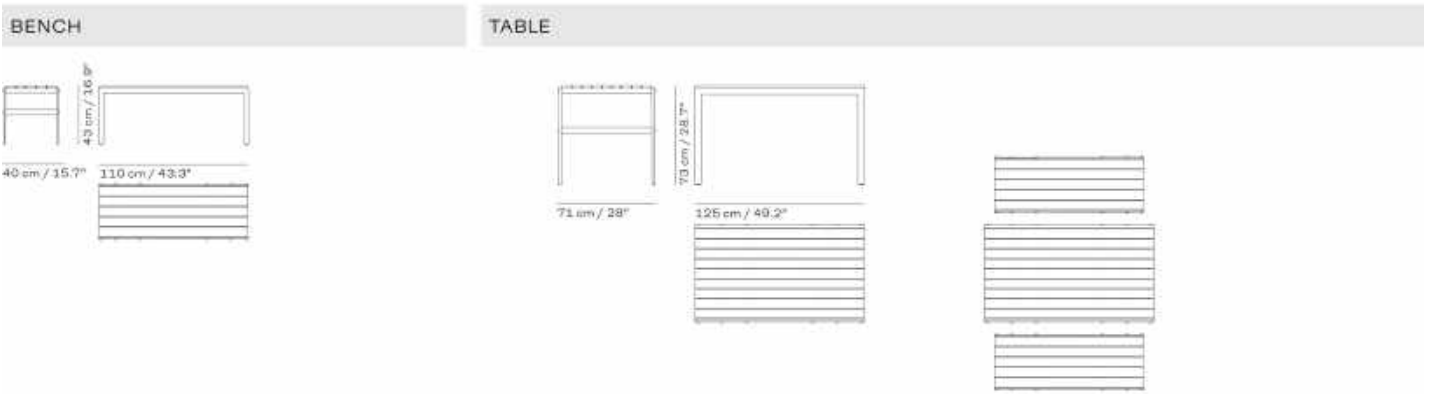



The Regatta Series of garden furniture profiles minimalist lines with soft curves that add character to outdoor spaces. Designed by Hans Thyge & Co design studio.

**CHAIRS**

ITEM NO.	DESCRIPTION	EXCL. VAT	INCL. VAT
S1508500	Regatta lounge chair, seat height 40 cm, teak FSC 100%	1.486	1.799

**STOOLS**

ITEM NO.	DESCRIPTION	EXCL. VAT	INCL. VAT
S1508700	Regatta lounge stool, seat height 41 cm, teak FSC 100%	635	769

**BENCHES**

ITEM NO.	DESCRIPTION	EXCL. VAT	INCL. VAT
S1508650	Regatta lounge bench, seat height 40 cm, teak FSC 100%	2.230	2.699

**TABLES**

ITEM NO.	DESCRIPTION	EXCL. VAT	INCL. VAT
S1508600	Regatta lounge table, table height 45 cm, teak FSC 100%	577	699

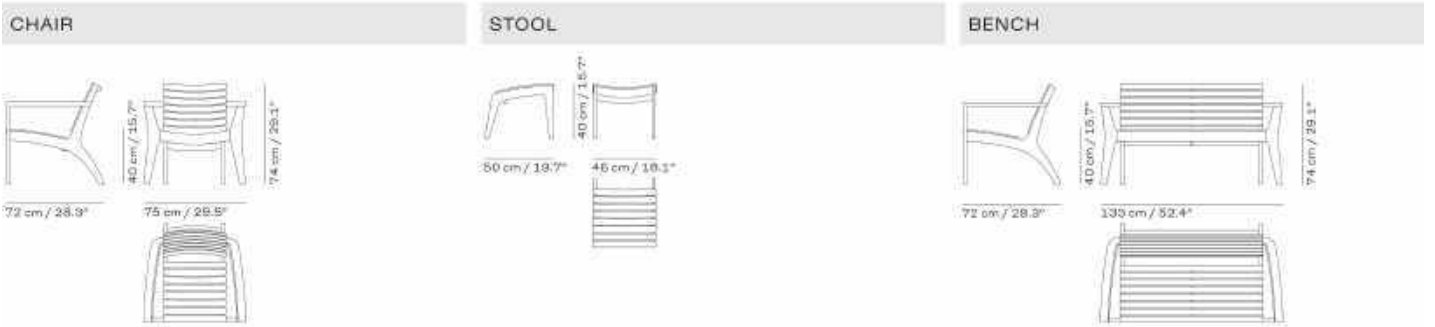



Designed in 1990 in collaboration with Danish designer, Povl B. Eskildsen, the versatile Riviera Collection has become an outdoor classic, renowned for its flexibility and straightforward appearance. Taking a sustainability approach, the design optimises the use of materials, using the slimmest possible amount in the teak slats without compromising strength. The ingenious construction is adjustable by design, allowing the pieces in the Riviera collection to transform in both expression and functionality and can easily be supplemented by a comfortable cushion.

**LOUNGE**

ITEM NO.	DESCRIPTION	EXCL. VAT	INCL. VAT
S1701516	Riviera lounge, seat height 33 cm, teak FSC 100%/stainless steel	2.561	3.099

**CUSHIONS LOUNGE**

ITEM NO.	DESCRIPTION	EXCL. VAT	INCL. VAT
1960848	Riviera lounge cushion, charcoal	470	569
1960849	Riviera lounge cushion, ash	470	569
1960850	Riviera lounge cushion, white	470	569
1961148	Riviera lounge cushion, papyrus	519	629
1961150	Riviera lounge cushion, golden yellow stripe	544	659

**SUNBEDS**

ITEM NO.	DESCRIPTION	EXCL. VAT	INCL. VAT
S1701515	Riviera sunbed, seat height 33 cm, teak FSC 100%/stainless steel	1.734	2.099

**CUSHIONS SUNBEDS**

ITEM NO.	DESCRIPTION	EXCL. VAT	INCL. VAT
1960844	Riviera cushion, charcoal	577	699
1960845	Riviera cushion, ash	577	699
1961270	Riviera cushion, cloud white	577	699
1960963	Riviera cushion, golden yellow stripe	577	699
1961146	Riviera cushion, papyrus	643	779

**LOUNGE**

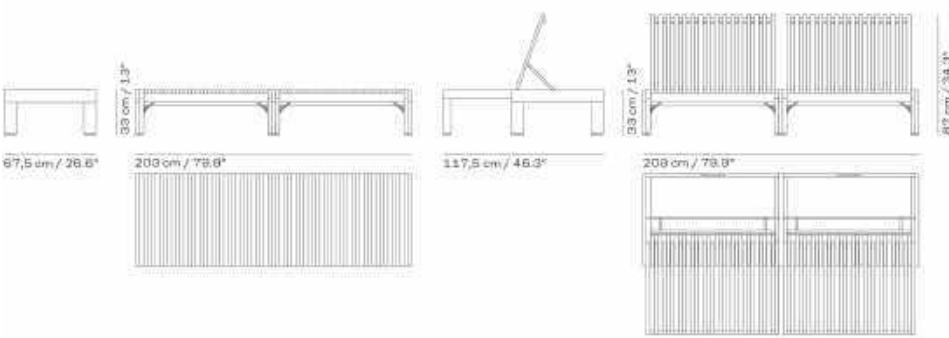

**CUSHION LOUNGE**



**SUNBED**

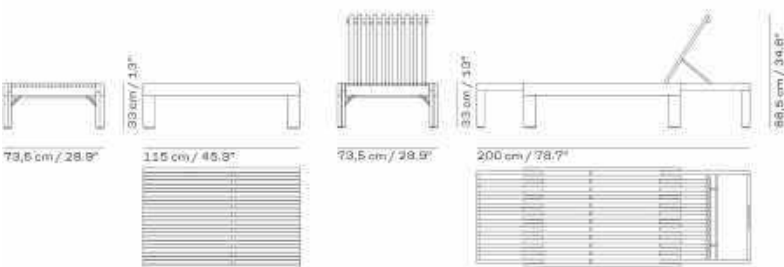

**CUSHION SUNBED**

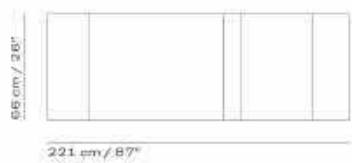



The Selandia series is known for its signature slight curves and elegant Nordic look with subtle French references that hint at long summer nights in the open air.

**CHAIRS**

ITEM NO.	DESCRIPTION	EXCL. VAT	INCL. VAT
S1400503	Selandia chair, teak FSC 100%, foldable	470	569
S1400505	Selandia armchair, teak FSC 100%, foldable	577	699
1400516	Selandia 2-seater, seat height 45 cm, teak FSC 100%, foldable	1.156	1.399

**CUSHIONS CHAIRS**

ITEM NO.	DESCRIPTION	EXCL. VAT	INCL. VAT
1961044	Selandia chair seat cushion, marine	81	99
1961045	Selandia chair seat cushion, ash	81	99
1961046	Selandia chair seat cushion, charcoal	81	99
1961047	Selandia chair seat cushion, white	81	99
1961143	Selandia chair cushion, papyrus	131	159
1961145	Selandia chair cushion, light apricot/dark green stripe	123	149

**CUSHIONS ARMCHAIRS**

ITEM NO.	DESCRIPTION	EXCL. VAT	INCL. VAT
1961040	Selandia armchair seat cushion, marine	98	119
1961041	Selandia armchair seat cushion, ash	98	119
1961042	Selandia armchair seat cushion, charcoal	98	119
1961274	Selandia armchair seat cushion, cloud white	98	119
1961142	Selandia armchair cushion, papyrus	131	159
1961144	Selandia armchair cushion, light apricot/dark green stripe	123	149

**TABLES**

ITEM NO.	DESCRIPTION	EXCL. VAT	INCL. VAT
1400519	Selandia table Ø94, table height 73 cm, teak FSC 100%, folds flat	1.073	1.299
1400518	Selandia table 75, table height 73 cm, teak FSC 100%, foldable	767	929
1400517	Selandia folding table 147, table height 73 cm, teak FSC 100%, foldable	1.280	1.549
S1450520	Selandia table, table height 73 cm, teak FSC 100%, foldable, hole in middle for parasol, extendable (extension plates sold separately)	2.726	3.299
1450525	Selandia extension leaf, teak FSC 100%	470	569

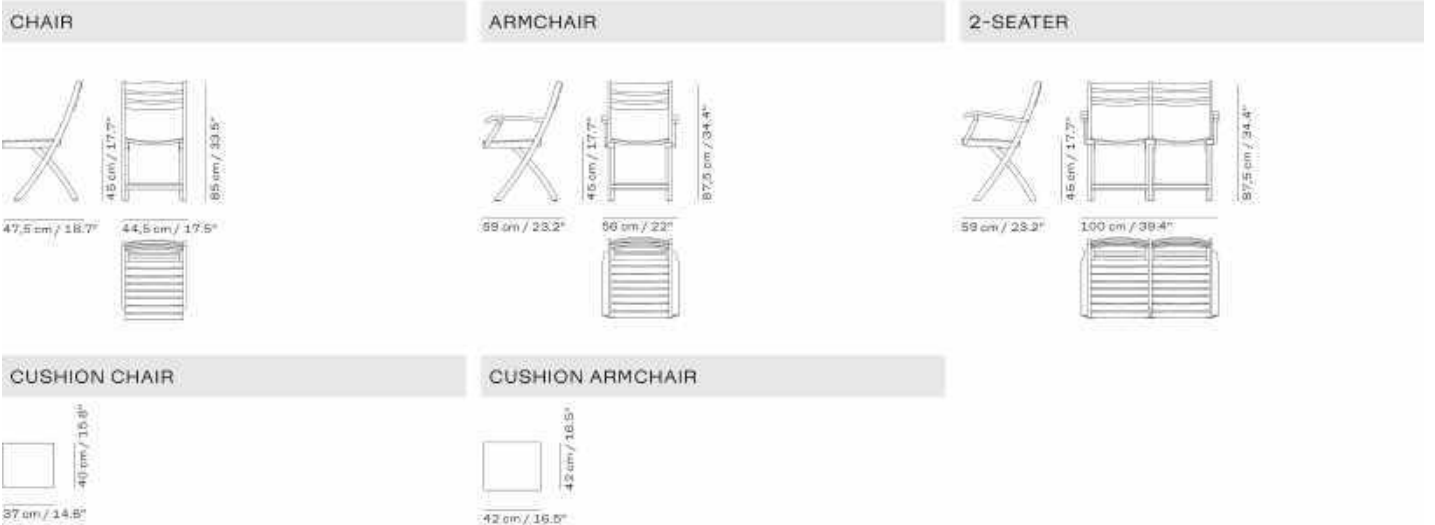



TABLE Ø94

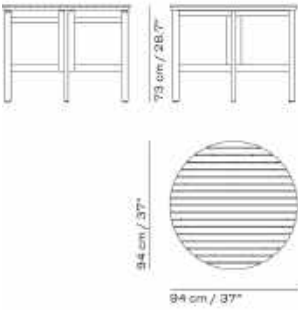

TABLE 75

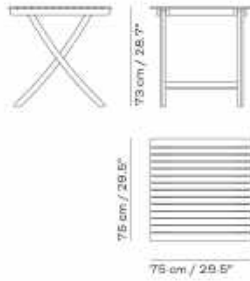
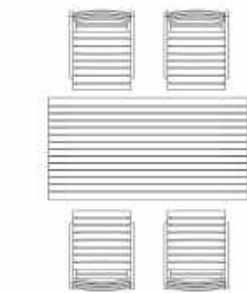
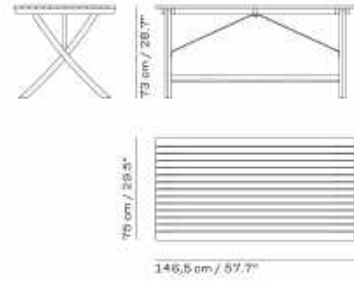
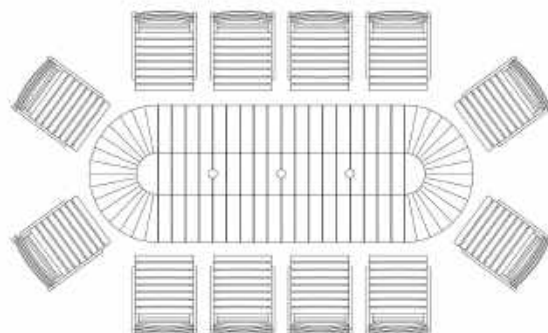
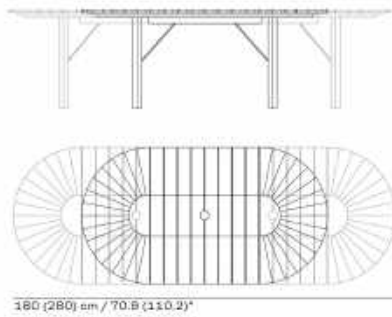
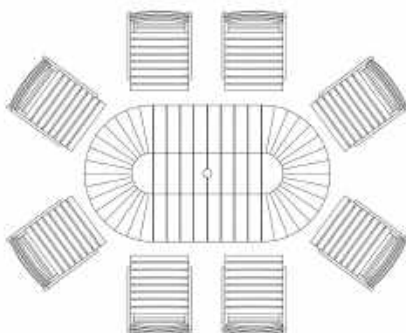
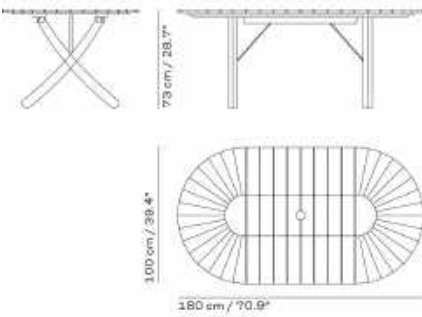

TABLE 147



TABLE



EXTENSION LEAF

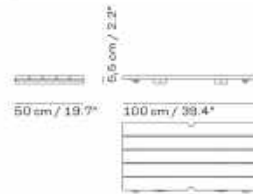



Named after the northernmost tip of Denmark, the Skagen series of outdoor furniture designed by Mogens Holmriis draws inspiration from the region's natural beauty. Characterised by meticulous craftsmanship and elegant silhouettes, the series is shaped from FSC-certified teak, a durable hard wood that patinates to a silver-grey hue over time.

**CHAIRS**

ITEM NO.	DESCRIPTION	EXCL. VAT	INCL. VAT
S1131005	Skagen chair, seat height 44 cm, teak FSC 100%,	577	699

**CUSHIONS CHAIRS**

ITEM NO.	DESCRIPTION	EXCL. VAT	INCL. VAT
1960828	Skagen chair cushion, charcoal	156	189
1960829	Skagen chair cushion, ash	156	189
1961268	Skagen chair cushion, cloud white	156	189
1960831	Skagen chair cushion, marine	156	189
1961048	Skagen chair cushion, golden yellow stripe	156	189
1961141	Skagen chair cushion, papyrus	156	189

**BENCHES**

ITEM NO.	DESCRIPTION	EXCL. VAT	INCL. VAT
S1131010	Skagen bench, seat height 44 cm, teak FSC 100%	1.073	1.299

**CUSHIONS BENCHES**

ITEM NO.	DESCRIPTION	EXCL. VAT	INCL. VAT
1960832	Skagen bench cushion, charcoal	288	349
1960833	Skagen bench cushion, ash	288	349
1961269	Skagen bench cushion, cloud white	288	349
1960835	Skagen bench cushion, marine	288	349
1961050	Skagen bench cushion, golden yellow stripe	288	349
1961140	Skagen bench cushion, papyrus	296	359

**TABLES**

ITEM NO.	DESCRIPTION	EXCL. VAT	INCL. VAT
S1131015	Skagen table, table height 73 cm, teak FSC 100%	1.238	1.499

**CHAIR**



**BENCH**

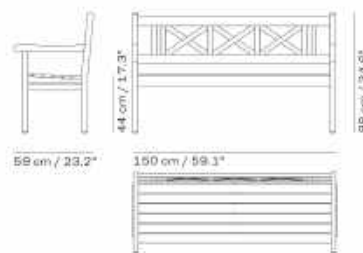

**CUSHION CHAIR**



**CUSHION BENCH**





TABLE

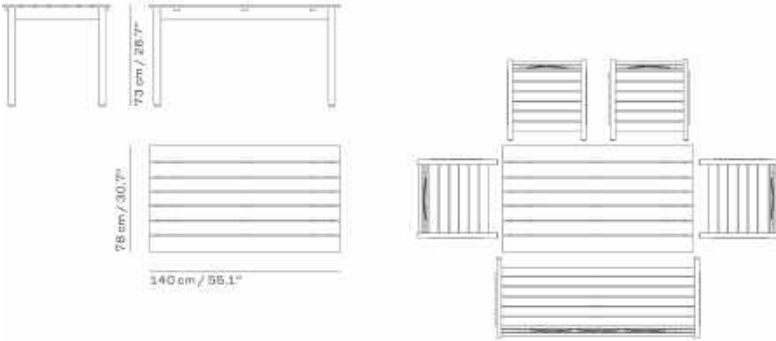



## SPIDER WEB ANDERS BRØGGER

01.2025

The Spider Web Drying Rack not only resembles the artistry of the tiny predator, it also shares its resilience and ability to stay captivating and functional in even the harshest surroundings. Crafted from durable teak wood and string for outdoor use. The wood patinates to a beautiful silver-grey over time.

### GARDEN

ITEM NO.	DESCRIPTION	EXCL. VAT	INCL. VAT
S1600670	Spider Web, height 180 cm, teak FSC 100%	1.280	1.549

### SPIDER WEB

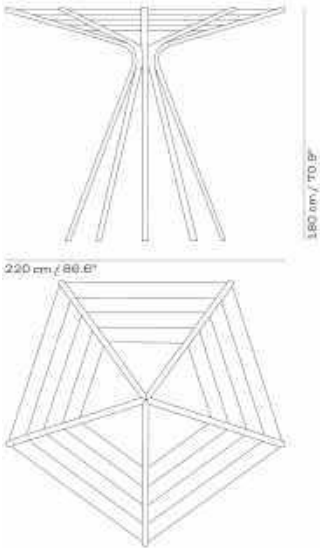





The flowing lines of the Steamer Deck Chair are inspired by the curved lines of a cruise ship. The chair has an integrated footrest that folds up easily when not in use. Steamer Deck Chair is crafted from high-quality teak in a clean and light expression with functionality and comfort at the forefront of this Nordic archetype.

DECK CHAIRS

ITEM NO.	DESCRIPTION	EXCL. VAT	INCL. VAT
S1550505	Steamer deck chair, seat height 32,5 cm, teak FSC 100%, reclining backrest, integrated footrest, folds flat	1.073	1.299

DECK CHAIR

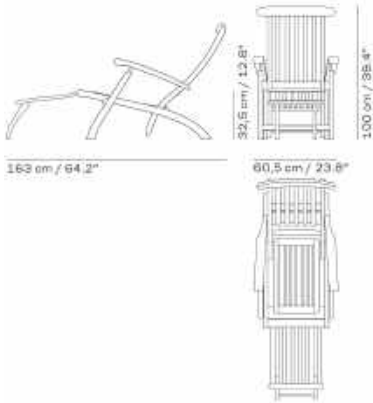



**TRADITION**  
POVL B. ESKILDSEN

Tradition is a modular lounge series in teak that brings refined sophistication to outdoor spaces. With the versatility to fit any lounging style preference, Tradition's elegance and comfort are an invitation to unwind. Designed for Fritz Hansen by Danish architect and designer Povl B. Eskildsen.

The spacer module for Tradition extends the outdoor lounge set with a generous extra seat. Crafted in the same high-quality materials and dedication to details, the spindle backrest sits perfectly with all other Tradition pieces and can be secured together to create a seamless and stable lounge experience.

**LOUNGE CHAIRS**

ITEM NO.	DESCRIPTION	EXCL. VAT	INCL. VAT
1505967	Tradition lounge chair, seat height 40 cm, teak FSC 100%, light sand	2.561	3.099
1505985	Tradition lounge chair, seat height 40 cm, teak FSC 100%, charcoal	2.313	2.799
1505988	Tradition lounge chair, seat height 40 cm, teak FSC 100%, honey yellow	2.561	3.099

**SOFA MODULES**

ITEM NO.	DESCRIPTION	EXCL. VAT	INCL. VAT
1505968	Tradition endmodule, seat height 40 cm, teak FSC 100%, light sand	2.313	2.799
1505984	Tradition endmodule, seat height 40 cm, teak FSC 100%, charcoal	2.065	2.499
1505987	Tradition endmodule, seat height 40 cm, teak FSC 100%, honey yellow	2.313	2.799
1505946	Tradition corner module, seat height 40 cm, teak FSC 100%, light sand	2.561	3.099
1505948	Tradition corner module, seat height 40 cm, teak FSC 100%, honey yellow	2.561	3.099
1505949	Tradition corner module, seat height 40 cm, teak FSC 100%, charcoal	2.313	2.799
1505969	Tradition spacer module, seat height 40 cm, teak FSC 100%, light sand	2.065	2.499
1505983	Tradition spacer module, seat height 40 cm, teak FSC 100%, charcoal	1.900	2.299
1505986	Tradition spacer module, seat height 40 cm, teak FSC 100%, honey yellow	2.065	2.499
1505995	Tradition pouf, seat height 40 cm, teak FSC 100%, charcoal	1.156	1.399
1505996	Tradition pouf, seat height 40 cm, teak FSC 100%, honey yellow	1.280	1.549
1505997	Tradition pouf, seat height 40 cm, teak FSC 100%, light sand	1.280	1.549

**TABLES**

ITEM NO.	DESCRIPTION	EXCL. VAT	INCL. VAT
1505992	Tradition lounge table, table height 27 cm, teak FSC 100%	809	979
1505993	Tradition lounge table, table height 40 cm, teak FSC 100%	809	979

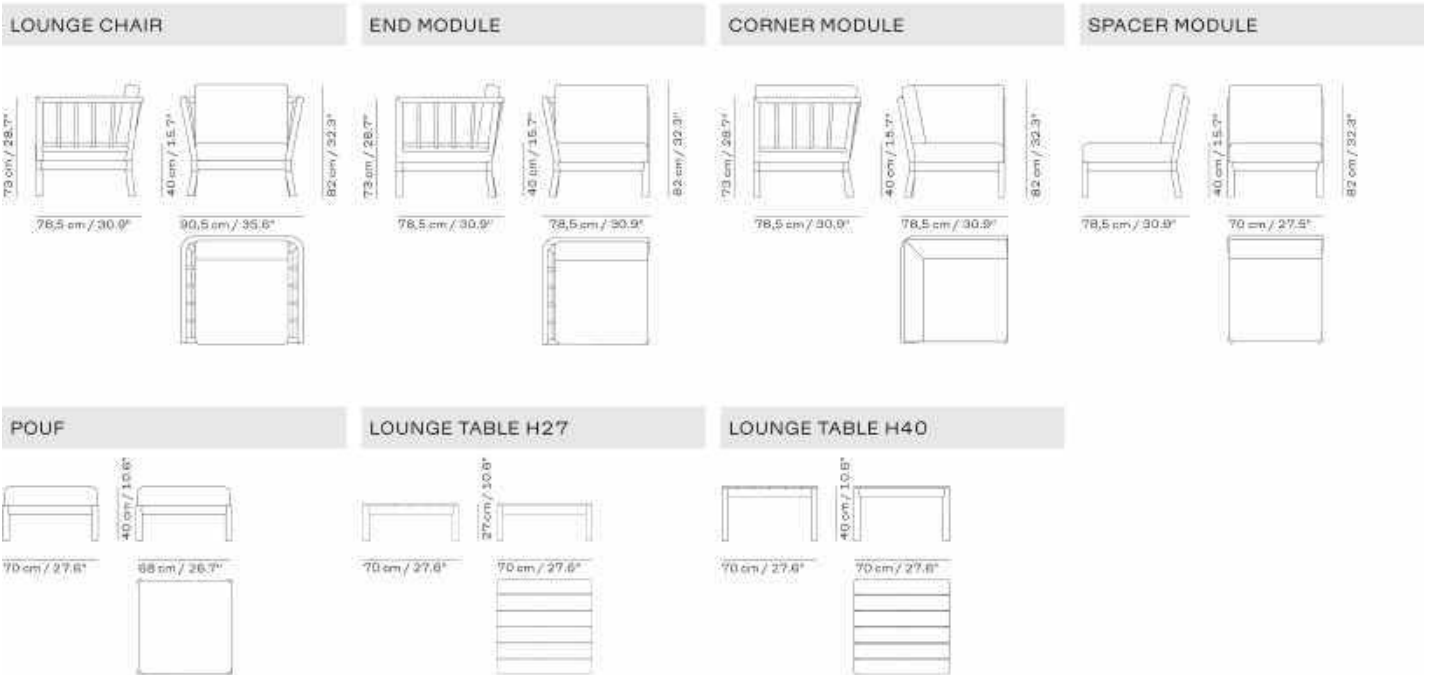



## UMBRELLAS SKAGERAK DESIGN

01.2025

Stay cool in the shade with beautiful, durable umbrellas crafted from long-lasting materials. Water and stain resistant fabric and wooden poles that can withstand wind and weather.

### ATLANTIS

ITEM NO.	DESCRIPTION	EXCL. VAT	INCL. VAT
1910091	Atlantis umbrella Ø330, dark blue stripes, Kapur FSC 100%, fits with Capri umbrella foot 50 kg	1.073	1.299
1910092	Atlantis umbrella Ø330, golden yellow stripes, Kapur FSC 100%, fits with Capri umbrella foot 50 kg	1.073	1.299
S1910090	Atlantis umbrella Ø330, off-white, Kapur FSC 100%, fits with Capri umbrella foot 50 kg	908	1.099
S1910095	Atlantis umbrella 330x330, off-white, Kapur FSC 100%, fits with Capri umbrella foot 50 kg	990	1.199

### CATANIA

ITEM NO.	DESCRIPTION	EXCL. VAT	INCL. VAT
S1910130	Catania umbrella Ø270, off-white, Kapur FSC 100%, fits with Capri umbrella foot 30 kg	280	339

### MESSINA

ITEM NO.	DESCRIPTION	EXCL. VAT	INCL. VAT
1910101	Messina umbrella Ø210, off-white, Kapur FSC 100%, fits with Capri umbrella foot 30 kg	362	439
1910111	Messina umbrella Ø270, off-white, Kapur FSC 100%, fits with Capri umbrella foot 30 kg	495	599
1910137	Messina umbrella Ø270, dark blue stripes, kapur FSC 100%, fits with Capri umbrella foot 30 kg	693	839
1910138	Messina umbrella Ø270, golden yellow stripes, kapur FSC 100%, fits with Capri umbrella foot 30 kg	693	839
1910118	Messina umbrella Ø300, lemon/sand stripe, kapur FSC 100%, fits with Capri umbrella foot 50 kg	866	1.049
1910119	Messina umbrella Ø300, lightapricot/darkgreen, kapur FSC 100%, fits with Capri umbrella foot 50 kg	866	1.049
1910135	Messina umbrella Ø300, off-white, Kapur FSC 100%, fits with Capri umbrella foot 50 kg	635	769
1910136	Messina umbrella 270x270, off-white, Kapur FSC 100%, fits with Capri umbrella foot 50 kg	594	719
1910121	Messina umbrella 300, lemon/sand stripe, kapur FSC 100%, fits with Capri umbrella foot 50 kg	908	1.099
1910122	Messina umbrella 300, light apricot/darkgreen, kapur FSC100%, fits with Capri umbrella foot 50 kg	908	1.099
S1910120	Messina umbrella 300, off-white, Kapur FSC 100%, fits with Capri umbrella foot 50 kg	693	839

### CAPRI

ITEM NO.	DESCRIPTION	EXCL. VAT	INCL. VAT
S1900620	Capri umbrella Foot 30 kg., max. dia. 4 cm	428	519
S1900625	Capri umbrella Foot 50 kg., max. dia. 5 cm	552	669

### OPTIONS

ITEM NO.	DESCRIPTION	EXCL. VAT	INCL. VAT
S1910200	Umbrella Cover 330x330 cm	98	119
S1910210	Umbrella Cover Ø330	81	99



ATLANTIS Ø330

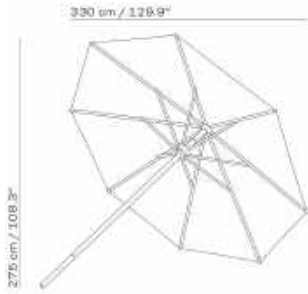

ATLANTIS 330X330

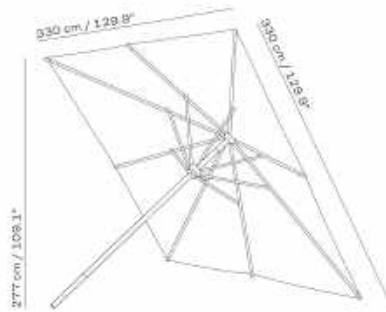

CATANIA Ø270

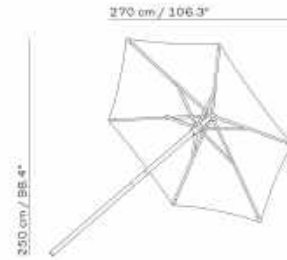

MESSINA Ø210

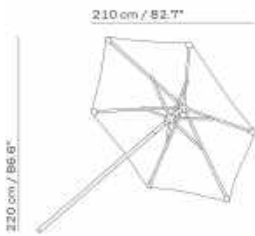

MESSINA Ø270

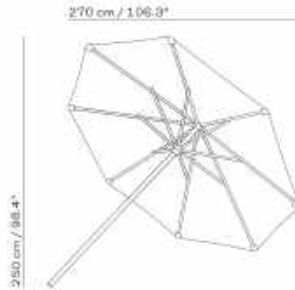

MESSINA Ø300

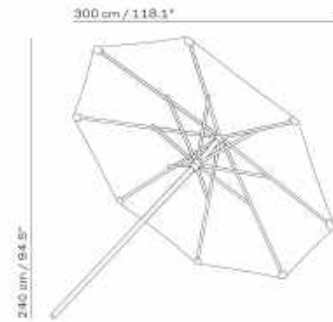

MESSINA 270X270

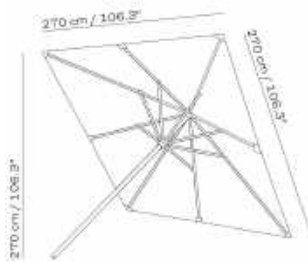

MESSINA 300X300

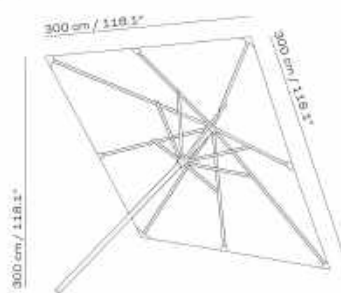

CAPRI 30



CAPRI 50





Made with smaller spaces in mind, the Vendia Series delivers all the elegance of traditional garden furniture in a scaled-down design that is ideal for balconies, patios and terraces where space is at a premium. Designed in collaboration with Danish Designer Mogens Holmriis

CHAIRS

ITEM NO.	DESCRIPTION	EXCL. VAT	INCL. VAT
S1600522	Vendia chair, seat height 45 cm, teak FSC 100%, foldable	371	449

TABLES

ITEM NO.	DESCRIPTION	EXCL. VAT	INCL. VAT
S1600400	Vendia table Ø75, table height 67 cm, teak FSC 100%	453	549

CHAIR



TABLE

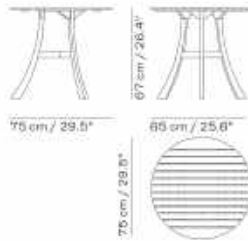

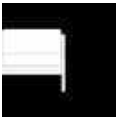

Virkelyst is a modern outdoor series characterised by clean lines, discreet details and high comfort. Designed by contemporary design studio, Says Who.

**CHAIRS**

ITEM NO.	DESCRIPTION	EXCL. VAT	INCL. VAT
1505731	Virkelyst chair, seat height 43 cm, teak FSC 100%, ash	1.528	1.849
1505732	Virkelyst chair, seat height 43 cm, teak FSC 100%, charcoal	1.528	1.849
1505720	Virkelyst chair, seat height 43 cm, teak FSC 100%, cloud white	1.528	1.849
1505737	Virkelyst chair, seat height 43 cm, teak FSC 100%, honey yellow	1.569	1.899
1505882	Virkelyst chair, seat height 43 cm, teak FSC 100%, golden yellow stripe	1.528	1.849
1505898	Virkelyst chair, seat height 43 cm, papyrus	1.528	1.849

**SOFAS**

ITEM NO.	DESCRIPTION	EXCL. VAT	INCL. VAT
1505776	Virkelyst 2-seater, seat height 43 cm, teak FSC 100%, honey yellow	2.726	3.299
1505781	Virkelyst 2-seater, seat height 43 cm, teak FSC 100%, ash	2.561	3.099
1505782	Virkelyst 2-seater, seat height 43 cm, teak FSC 100%, charcoal	2.561	3.099
1505721	Virkelyst 2-seater, seat height 43 cm, teak FSC 100%, cloud white	2.561	3.099
1505883	Virkelyst 2-seater, seat height 43 cm, teak FSC 100%, golden yellow stripe	2.561	3.099
1505897	Virkelyst 2-seater, seat height 43 cm, papyrus	2.561	3.099
1505777	Virkelyst 3-seater, seat height 43 cm, teak FSC 100%, honey yellow	3.552	4.299
1505779	Virkelyst 3-seater, seat height 43 cm, teak FSC 100%, golden yellow stripe	3.304	3.999
1505783	Virkelyst 3-seater, seat height 43 cm, teak FSC 100%, ash	3.304	3.999
1505784	Virkelyst 3-seater, seat height 43 cm, teak FSC 100%, charcoal	3.304	3.999
1505722	Virkelyst 3-seater, seat height 43 cm, teak FSC 100%, cloud white	3.304	3.999
1505896	Virkelyst 3-seater, seat height 43 cm, papyrus	3.304	3.999

**POUFS**

ITEM NO.	DESCRIPTION	EXCL. VAT	INCL. VAT
1505791	Virkelyst pouf, seat height 43 cm, teak FSC 100%, ash	1.032	1.249
1505792	Virkelyst pouf, seat height 43 cm, teak FSC 100%, charcoal	1.032	1.249
1505723	Virkelyst pouf, seat height 43 cm, teak FSC 100%, cloud white	1.032	1.249
1505797	Virkelyst pouf, seat height 43 cm, honey yellow	1.073	1.299
1505887	Virkelyst pouf, seat height 43 cm, teak FSC 100%, golden yellow stripe	1.032	1.249
1505899	Virkelyst pouf, seat height 43 cm, papyrus	1.032	1.249

**TABLES**

ITEM NO.	DESCRIPTION	EXCL. VAT	INCL. VAT
1505774	Virkelyst table, High, table height 66,5 cm, teak FSC 100%	1.114	1.349
S1505753	Virkelyst table, table height 38 cm, teak FSC 100%	1.032	1.249
S1505770	Virkelyst table, table height 30 cm, teak FSC 100%	627	759

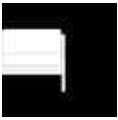

LOUNGE CHAIR

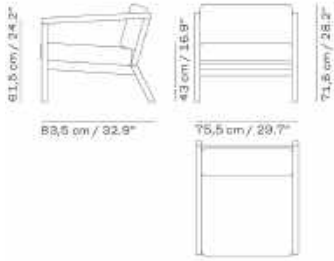

2-SEATER

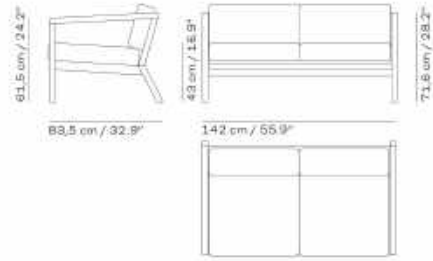

3-SEATER

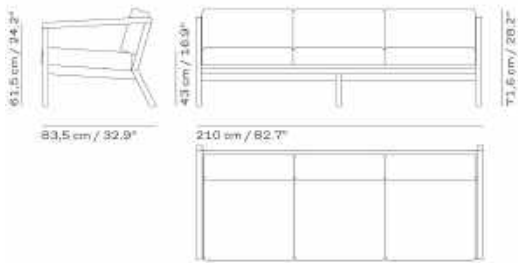

POUF

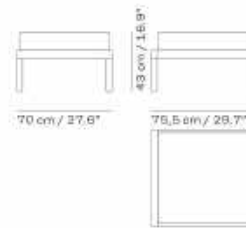
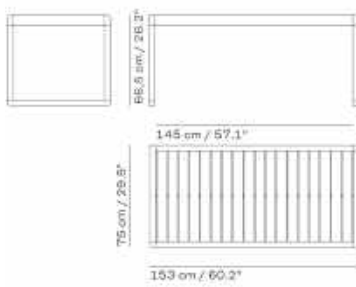

TABLE HIGH



TABLE

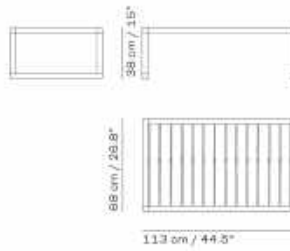
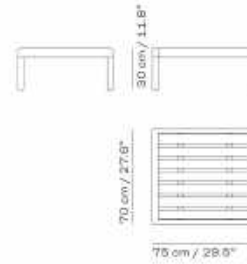

TABLE SMALL





## CAREKIT

01.2025

Clean, scrub and restore garden furniture with the Outdoor Care Kit. Packaged in a reusable cardboard box made in collaboration with a local social enterprise, Garden Wood Cleaner prevents build up from algae and dirt, eliminating mold and mildew damage. The corresponding scrub brush in wood and natural bristles is made in collaboration with a workshop for the blind and sight impaired.

### SPARE PARTS

ITEM NO.	DESCRIPTION	EXCL. VAT	INCL. VAT
1103050	Care kit, wood cleaner and wooden cleaning brush	32	39





**CURA**  
**SKAGERAK DESIGN**

**01.2025**

Cura is a series of oils and soap specially formulated to care for indoor and outdoor wooden furniture, ensuring it retains its colour and beauty with time and use.

**SPARE PARTS**

ITEM NO.	DESCRIPTION	EXCL. VAT	INCL. VAT
1103043	Cura oil nature, wood care for outdoor furniture	15	19

# SURFACE SELECTION

# SURFACE SELECTION

## INVENTORY

- 40 • Textiles
- 42 • Wood
  - Concrete
  - Limestone
  - Cast iron
  - Metal

---

## WE SUPPORT SUSTAINABLE WOOD SOURCING

One important step towards a more sustainable design industry is to support responsible wood sourcing and forest management. That is why we endorse the Forest Stewardship Council™ by increasing the total share of FSC™-certified wood in our production. Doing so, we help make sure that no more trees are felled than the forest can reproduce – and that local communities, biodiversity and forest workers are treated with respect. Since the FSC™ certification covers some areas of the world more thoroughly than others, we also take in PEFC-certified wood from Canada and the like.

Furthermore, we adhere to EU's Timber Regulation from 2013. This means that we perform due diligence on all shipments covered by the EUTR, to ensure that the wood comes from legal sources.

Look for our FSC-certified products.



**The mark of  
responsible forestry**

# SURFACE SELECTION

## TEXTILES

	ASH	CHARCOAL	CLOUD WHITE	DARK BLUE / SAND CHECKER	DARK BLUE STRIPE*	GOLDENYELLOW STRIPE	GOLDENYELLOW STRIPE*	HONEYYELLOW	LEMON / SAND STRIPE	LIGHT APRICOT / DARK GREEN	LIGHT SAND	MARINE	OFF-WHITE 100z*	OFF-WHITE 80z*	PAPYRUS	WHITE
ATLANTIS 330X330													●			
ATLANTIS Ø330					●		●						●			
BARRIERE SEAT CUSHION 125X43	○	○				○										
BARRIERE SEAT CUSHION 43X43	○	○				○						○				○
BARRIERE SEAT CUSHION 55X43	○	○				○						○				○
BARRIERE DECK CHAIR CUSHION	●	●	○			○						○			●	
BARRIERE DECORATIVE PILLOW 50X40				○		●		○	●	●					●	
BARRIERE DECORATIVE PILLOW 60X50				○		●		○	●	●					●	
BETWEEN LINES DECK CHAIR CUSHION	●	●							●						●	
CATANIA Ø270														●		
DRACHMANN SERIES CUSHION	●	●							●	●		○			●	
LILIUM SERIES CUSHION	○	○										○			●	○
MESSINA 270X270													●			
MESSINA 300X300									●	●			●			
MESSINA Ø210													●			
MESSINA Ø270					●		●						●			
MESSINA Ø300									●	●			●			
PELAGUS SERIES CUSHION	●	●						○								
RIVIERA LOUNGE CUSHION	●	●				●									●	○
RIVIERA SUNBED CUSHION	●	●	○			●									●	
SELANDIA SERIES CUSHION	●	●	○							●		○			●	○
SKAGEN SERIES CUSHION	●	●	○			●						○			●	
TRADITION SERIES		●						○			○					
VIRKELYST SERIES	●	●	○			●		○							●	

- \* Only used on umbrellas
- Available in all markets excl. UK
- Available in all markets incl. UK

# SURFACE SELECTION

Colours and materials may vary from the images shown.  
Actual colour, gloss level and structure may vary.

## TEXTILES

### CUSHIONS, PILLOWS AND UMBRELLAS



**CHARCOAL**

Agora® Panama  
100% Solution-dyed  
Acrylic  
20.000 Martindale

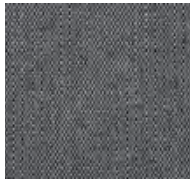

**ASH**

Agora® Panama  
100% Solution-dyed  
Acrylic  
20.000 Martindale



**MARINE**

Agora® Panama  
100% Solution-dyed  
Acrylic  
20.000 Martindale



**CLOUD WHITE**

Natté  
100% Sunbrella Acrylic



**WHITE**

Agora® Panama  
100% Solution-dyed  
Acrylic  
20.000 Martindale



**PAPYRUS**

Heritage  
50% Recycled Sunbrella  
Acrylic, 47 % Sunbrella  
Acrylic, 3% PES  
22.000 Martindale



**LIGHT SAND**

Lopi  
100% Sunbrella Acrylic  
90.000 Martindale



**HONEY YELLOW**

Lopi  
100% Sunbrella Acrylic  
90.000 Martindale

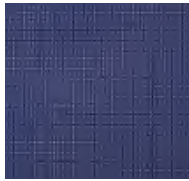

**DARK BLUE /  
SAND CHECKER**

Domino  
100% Sunbrella Acrylic  
80.000 Martindale



**LEMON / SAND**

Agora® Lines  
100% Solution-dyed  
Acrylic  
20.000 Martindale



**LIGHT APRICOT /  
DARK GREEN**

Agora® Lines  
100% Solution-dyed  
Acrylic  
20.000 Martindale



**GOLDEN YELLOW**

Acrisol® Egeo  
100% Dyed Fiber Acrylic  
20.000 Martindale

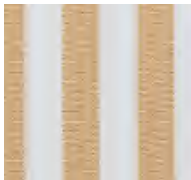

**GOLDEN YELLOW**

Agora® Lines  
100% Solution-dyed  
Acrylic  
20.000 Martindale



**DARK BLUE STRIPE**

Agora® Lines  
100% Solution-dyed  
Acrylic  
20.000 Martindale

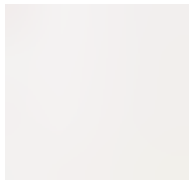

**OFF WHITE**

100% piece dyed  
polyester

### SUNBEDS & LOUNGE CHAIRS



**SLING, SAND**

Pelagus (Sunbed)  
Pelagus (Lounge chair)



**SUNTEXTURE, WHITE**

Columbus (Sunbed)

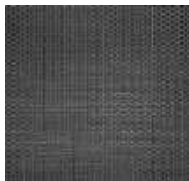

**SUNTEXTURE, BLACK**

Columbus (Sunbed)

# SURFACE SELECTION

Colours and materials may vary from the images shown.  
Actual colour, gloss level and structure may vary.

## UNTREATED SOLID WOOD



TEAK

- Ballare
- Banco
- Between Lines
- Columbus
- Cutter
- Drachmann
- England
- Lilium
- Pantry
- Pelagus
- Plank
- Reform
- Regatta
- Riviera
- Selandia
- Skagen
- Spider Web
- Steamer
- Tradition
- Vendia
- Virkelyst



WESTERN RED CEDAR

- Overlap

## CLEAR LACQUERED SOLID WOOD



KAPUR

- Atlantis
- Catania
- Messina

## CONCRETE



GREY

- Capri

## LIMESTONE



JURA BEIGE

- Pantry

## CAST IRON



BLACK

- Helios

## POWDER COATED METAL (STEEL OR ALUMINIUM)



HUNTER GREEN -  
TEXTURED

- Overlap
- Pelagus
- Reform



ANTHRACITE BLACK -  
TEXTURED

- Overlap
- Reform

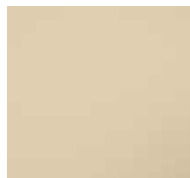

LIGHT IVORY -  
TEXTURED

- Pelagus

## STEEL



BRUSHED STAINLESS  
STEEL - MATT

- Lilium

# PRICE LIST 2025

POUL KJÆRHOLM

EURO / EXCL. VAT 21% / 01.2025

FRITZ HANSEN

# CONTENT

## 03 • GENERAL TERMS AND CONDITIONS

### CHAIRS

- 05 • PK8™
- 06 • PK9™
- 07 • PK11™
- 08 • PK15™

### LOUNGE AND SOFAS

- 09 • PKO A™
- 10 • PK4™
- 11 • PK20™
- 12 • PK22™
- 13 • PK24™
- 14 • PK25™
- 15 • PK26™
- 16 • PK31™
- 17 • PK33™
- 18 • PK80™
- 19 • PK81™
- 20 • PK91™

### TABLES

- 21 • PK40™
- 22 • PK51™/PK55™
- 23 • PK54™/PK54A™
- 24 • PK58™
- 25 • PK60™
- 26 • PK61™/PK61A™
- 27 • PK62™
- 28 • PK63™/PK63A™
- 29 • PK65™
- 30 • PK71™

### SURFACE SELECTION

- 31 • Surface Selection



# GENERAL TERMS AND CONDITIONS

## CURRENCY & EFFECTIVE DATE

This price list is valid from 1 January 2025 and cancels all prior price lists.

Reservation is made for any errors and omissions. Furthermore, below general terms and conditions shall apply to all contracts under which Fritz Hansen A/S (Fritz Hansen) is the supplier/sub-supplier.

## ORDERING

Orders must be placed through Fritz Hansen's web-based order system called the Partner Portal ([www.fritzhansen.com](http://www.fritzhansen.com) - professional). Orders are not binding until the customer has received a written order confirmation from Fritz Hansen.

Price lists state the recommended retail price (RRP) or prices excl. VAT exclusive of freight and fees. All prices can be changed without notice. Changes to the collection such as discontinued products and/or items out of stock can occur even when stated differently in the price list. Updated information will be available on the partner portal only.

## ORDER CANCELLATION

Orders can be cancelled in accordance with the below rules:

	ORDERS CANCELLED 0-3 DAYS AFTER ORDER CONFIRMATION HAS BEEN SENT	ORDERS CANCELLED 3-14 DAYS AFTER ORDER CONFIRMATION HAS BEEN SENT
STANDARD PRODUCTS	FEE: NONE	FEE: 5% OF NET PRICE EXCL. VAT.
SPECIALS OR MODIFIED PRODUCTS	FEE: FULL PRICE	

Change and cancellation of order after 14 days from receipt of the order confirmation is not possible.

## DELIVERY

The following freight rates apply:

RATE	PER ORDER
EU+UK+NO+CH+US*	DKK 200 / € 55 / £ 50 / SEK 600 / NOK 550 / USD 55 EXCL. VAT.
REST OF THE WORLD	TO BE PICKED UP AT FRITZ HANSEN WAREHOUSES

For markets EU+UK+NO+CH+US free freight offered according to the following rates: Free shipping from DKK 3.000 / € 400 / £ 350 / SEK 4.500 / NOK 4.000 / USD 500 total order value excl. VAT.

\* For deliveries to outer areas such as islands in Portugal and Spain as well as Svalbard in Norway and others, a surcharge of DKK 420 / € 56 / £ 42 / NOK 580 per parcel will apply.

### Standard delivery terms:

- Denmark: DDP delivery address (INCO-Terms 2020)
- Countries within the EU: DDP delivery address (INCO-Terms 2020)
- European countries outside the EU: DAP delivery address (INCO-Terms 2020)
- USA: DDP delivery address (INCO-Terms 2020)
- Canada DAP delivery address (INCO-Terms 2020)
- Japan: DDP delivery address (INCO-Terms 2020)
- South Korea: DDP Fritz Hansen Busan (INCO-Terms 2020)
- Middle East, Asia, South and Central America, Australia: FCA Fritz Hansen warehouses in Denmark (INCO-Terms 2020)

For FCA: The goods must be picked up at the Fritz Hansen warehouses no later than 30 calendar days after the confirmed shipping date of the consolidated order. Address(es) for pickup will be specified on the commercial invoice. If the goods are not picked up, Fritz Hansen will charge the customer DKK 24 / € 3 / USD 4 per day per colli (all furniture orders are colli based) or pallet (all Lighting, Accessories, and Skagerak Collection orders are pallet based).

If the partner so desires, Fritz Hansen can deliver at the end user's address against an additional fee.

## CLAIMS

The physical product must be inspected upon delivery. Damage incurred in transit as well as any defects and deficiencies on the product incurred as a result of transportation must be recorded on the POD upon delivery. Fritz Hansen must be notified in writing of any claims about product defects and deficiencies within 48 hours of delivery. If the claims are made in due time and with the acceptance of Fritz Hansen, the customer is entitled to demand a replacement delivery or to have the defect remedied. The customer cannot demand a reduction or a compensation. Claims/replacements can only be made to the customer's address if delivery has not been made directly to the end user.

## TERMS OF PAYMENT

Terms of payment are 30 days net cash from invoice date. Invoices are issued and dated when the goods are dispatched. In case of late payment, interest will be charged at a rate of 1.5 % for every month or part thereof as from the due date. Interest invoices are payable net cash within eight days. Fritz Hansen can decide that the customer shall pay in advance, if the customer's balance is or has previously been due, or if the order amount exceeds the credit limit approved by Fritz Hansen.

## OBSERVATION OF TITLE

Title to the goods shall not pass to the customer until Fritz Hansen (or any third party to whom Fritz Hansen has assigned its rights to the purchase price) has received the full purchase price and been reimbursed any expenses incurred.

## WARRANTY

Fritz Hansen provides a standard five-year warranty on standard products within the collections Furniture and Skagerak Collection (Indoor & Outdoor) against defects in materials and workmanship. For the Arne Jacobsen shell chairs (Ant™, Grand Prix™, Lily™, Series 7™), the standard warranty is 10 years. Within the Furniture collection, an extended warranty of up to 10 years is provided on selected products, provided they have been registered online on [www.fritzhansen.com/my-fh](http://www.fritzhansen.com/my-fh) (see table on the next page for details).

Exception exists for AJ Children's Chairs, Series 7™ Junior, Series 7™ Cushion, Coat Tree™ Wall, Dot™, High Dot™ and AJ Trolley™ which are included in the Accessories warranty terms.

For the Poul Kjærholm collection, the standard warranty is 20 years except for PK0 A™ and PK60™, which is 10 years, and the PK15™, which is 5 years. Wicker and French Cane have a warranty of 2 years.

For the Lighting, Accessories and Skagerak Collection Accessories the standard warranty is 2 years. Specific for the Lighting category: Transformers, ballasts, light sources, and other electronic devices are subject to the warranty terms of the manufacturer in question. Fritz Hansen does not cover costs related to installation and dismantling, replacement of ballasts/transformers and other similar costs related to electricians and the like.

The warranty on all collections does not extend to ordinary tear, wear or damage to upholstery. On any material, textile, or leather which is not listed in our price lists configured on a specific product, the standard warranty is 2 years. The warranty is void upon subsequent changes to the product.

Additional warranty conditions can be found on [www.fritzhansen.com](http://www.fritzhansen.com).

## LIMITATION OF LIABILITY

Fritz Hansen will assume no liability for any loss as a result of delays, defects or any other breach of contract, unless such loss was caused by gross negligence on the part of Fritz Hansen. Fritz Hansen will assume no liability for any indirect loss, including loss of profits, operating loss, goodwill, loss of customers, running costs or any other consequential economic loss.

## CHOICE OF LAW AND JURISDICTION

Disputes between Fritz Hansen and its customers shall be subject to Danish law, except for the international civil law rules of Danish law, and shall be settled by Fritz Hansen's home court.

## MEASUREMENTS

The stated measurements act only as a guideline. The measurements can vary, and size difference on a product can occur.

## FORCE MAJURE

Fritz Hansen is without liability for non-performance of Fritz Hansen's obligations in respect to any orders received, if such non-performance is due to circumstances out of Fritz Hansen's reasonable control, which prevent the fulfilment of the purchase agreement or makes the fulfilment unreasonably burdensome. As examples of such circumstances the following can be mentioned: Industrial dispute and other circumstances which are beyond the control of the parties, such as fire, war, mobilization or calling in for military service of similar extent, requisition, seizure, exchange

controls, riots or disturbances, shortage of means of transportation, ordinary scarcity of goods, restrictions of motive power and defects in or late performance from sub-suppliers due to any of the aforementioned circumstances.

The above circumstances only lead to exemption from liability if their influence on the fulfilment of the purchase agreement could not be anticipated at the conclusion of the agreement. Fritz Hansen must without undue delay notify the customer in writing if any such circumstances, occurrence and cessation, if Fritz Hansen wishes to invoke any grounds of exemption from liability.

Regardless of what follows from these general conditions of sales and delivery, any party is entitled to terminate the purchase agreement by notifying the other party in writing, if the fulfilment of the agreement is prevented for more than 6 months due to one of the above circumstances.

Unless mandatory rules preclude this, Fritz Hansen is in no case liable to the customer for operating losses, lost earnings, or other financial consequential damages under these general conditions for sale and delivery.

## PRIVACY POLICY

At Fritz Hansen, confidentiality and data protection is a high priority. Guidelines for processing of personal data and description of the customer's and end users' rights according to applicable data protection law is governed by Fritz Hansen's privacy policy available on Fritz Hansen's website.

# WARRANTY OVERVIEW

Price list collections	Furniture Collection						Poul Kjærholm Collection				Skagerak Collection		Lighting Collection	Accessories Collection					
	Textiles, Cushions	Leather (1)	Leather (2)	Bases (3)	Bases (4)	Movable parts (5)	Anrt™ Grand Prix™, Lily™, Series 7™	Shells, Tabletops	Tabletops (6)	China Chair™	French Cane, Wicker	PK15™	PKO A™ & PK60™	Poul Kjærholm Collection	Outdoor	Indoor	Lighting	Accessories	Skagerak Collection
2 years										x							x	x	x
5 years	x	x		x		x		x			x			x	x				
10 years			x*		x*		x	x*				x**							
20 years									x**				x**						

1. Leather: Soft and Essential
2. Leather: Aura, Rustik, Natural, Grace and Embrace
3. Bases: Lacquered and Wooden (chairs), Powder coated (chairs and tables)
4. Bases: Aluminium, Chrome and Wooden (tables)
5. Moveable parts: Automatic return, Tilt, Height-adjustable, Swivel, Castors and Extension mechanism
6. Tabletops: Lacquer under tabletop, Lacquer on edges and Surface on tabletop

\* Additional with registration on [www.fritzhansen.com/my-fh](http://www.fritzhansen.com/my-fh)

\*\* Standard without registration



**PK8™**  
**POUL KJÆRHOLM 1978/2007**

**01.2025**

The PK8™ chair comes with a black or white shell front upholstered in a select range of leather types. The three-legged base is made of anodised satin brushed aluminium, while the shell is made of lacquered nylon plastic (PA).

MODEL	DESCRIPTION	CATEGORY 4	CATEGORY 5
PK8	Chair, 44 cm, anodised satin brushed aluminium legs	2.395	2.974

CATEGORY 4: AURA  
 CATEGORY 5: GRACE

PK8

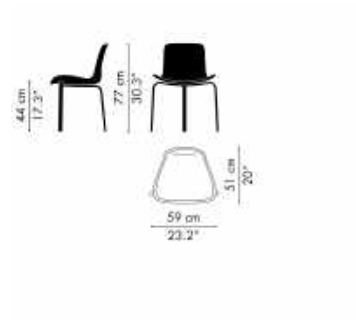



**PK9™**  
**POUL KJÆRHOLM 1960**

**01.2025**

The PK9™ is a fully upholstered chair in a select range of leather types. The three-legged base is made of satin brushed stainless spring steel. The inner shell is made of nylon.

MODEL	DESCRIPTION	CATEGORY 4	CATEGORY 5
PK9	Chair, 43 cm, satin brushed stainless spring steel legs	4.957	5.536

CATEGORY 4: AURA  
 CATEGORY 5: GRACE, EMBRACE, NATURAL

**OPTIONS**

DESCRIPTION	PRICE
Glides	156

**PK9**

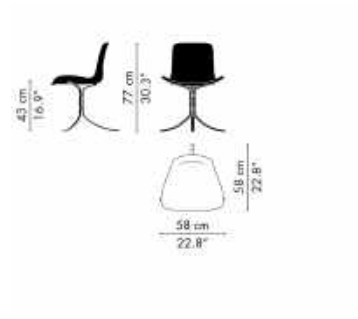



**PK11™**  
**POUL KJÆRHOLM 1957**

**01.2025**

The PK11™ armchair comes with armrests in clear lacquered ash and an upholstered seat in a select range of leather types. The base is made of satin brushed stainless steel.

MODEL	DESCRIPTION	CATEGORY 4	CATEGORY 5
PK11	Armchair, 43/44 cm, satin brushed stainless steel legs	3.222	3.635

CATEGORY 4: AURA  
CATEGORY 5: GRACE, EMBRACE, NATURAL

**PK11**

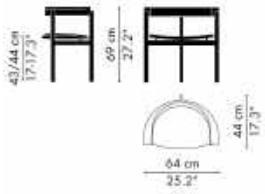



**PK15™**  
POUL KJÆRHOLM 1979

01.2025

Consisting of two materials, the PK15 is available in two configurations: clear lacquered ash or black coloured ash, both with a natural French cane seat. An additional loose seat cushion in either black or natural leather is also available.

MODEL	DESCRIPTION	BLACK COLOURED ASH	CLEAR LACQUERED ASH
PK15	Chair, seat height 17.7", Wicker seat	2.313	2.561

MODEL	DESCRIPTION	CATEGORY
PK15CU	Seat cushion (loose)	5 437

CATEGORY 5 - SEE THE SURFACE SELECTION  
Grace black or natural leather

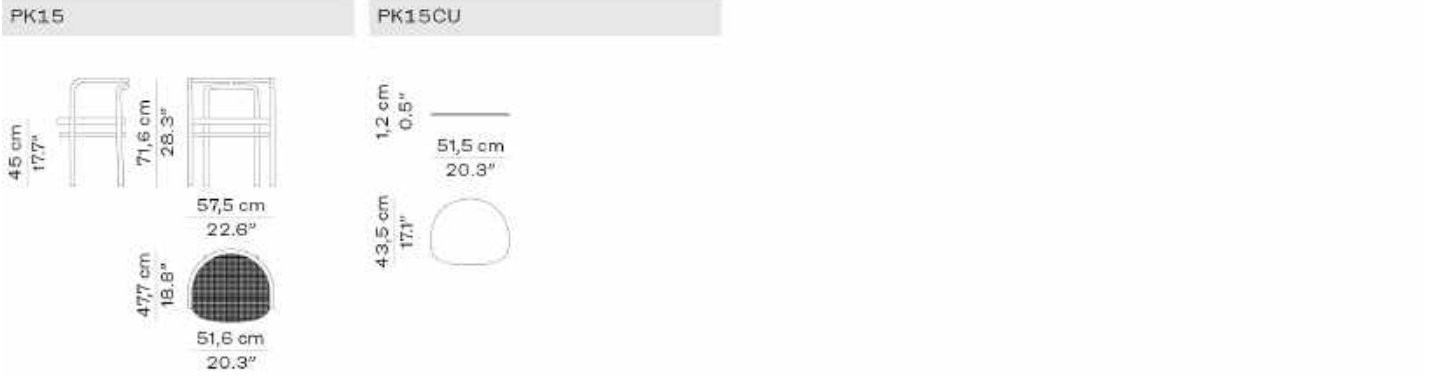



PKO A™  
POUL KJÆRHOLM 1952

01.2025

The PKO A™ lounge chair is made from two pressure moulded veneer shells and is available in two different finishes: Clear lacquered Oregon Pine or black coloured ash. Between the two shell parts are two cinnabar red spacers.

MODEL	DESCRIPTION	BLACK COLOURED ASH	OREGON PINE
PKO A	Lounge chair, pressure moulded veneer	2.230	2.313

PKO A

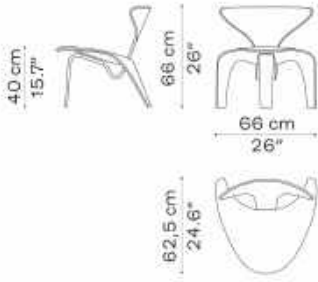



**PK4™**  
**POUL KJÆRHOLM 1952**

**01.2025**

The PK4™ lounge chair is made from stainless steel tubing and flag halyard in natural or black. The frame is available in brushed or black powder-coated steel. PK4™ is available in 3 configurations and with 3 optional cushions in either canvas or leather.

MODEL	DESCRIPTION	FLAG HALYARD	CANVAS	CATEGORY 5
PK4	PK4™ Lounge chair, brushed stainless or black powder coat	1.817		
PK4ST	PK4™ Lounge chair, brushed stainless or black powder coat, including cushion		2.065	2.147

FLAG HALYARD COLOURS - SEE THE SURFACE SELECTION  
 NATURAL, BLACK

CANVAS COLOURS - SEE THE SURFACE SELECTION  
 NATURAL, BLACK

CATEGORY 5 - SEE THE SURFACE SELECTION  
 Grace black leather

**PK4**

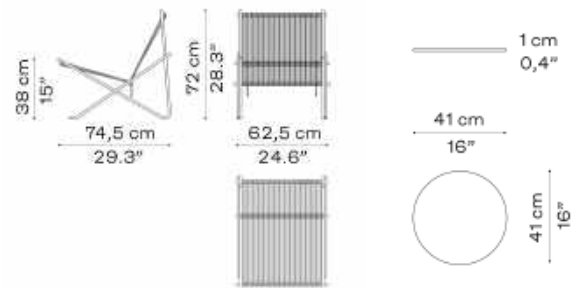





**PK20™**  
**POUL KJÆRHOLM 1968**

**01.2025**

The PK20™ lounge chair is available in a select range of leather types or wicker. The leather version also includes a matching leather headrest. The base is made of matt chromed spring steel.

MODEL	DESCRIPTION	WICKER	CATEGORY 4	CATEGORY 5
PK20	Lounge chair, leather, leather headrest, matt chromed spring steel base		10.329	11.569
PK20	Lounge chair, wicker, matt chromed spring steel base	7.354		

CATEGORY 4: AURA  
 CATEGORY 5: GRACE, EMBRACE, NATURAL

**PK20**

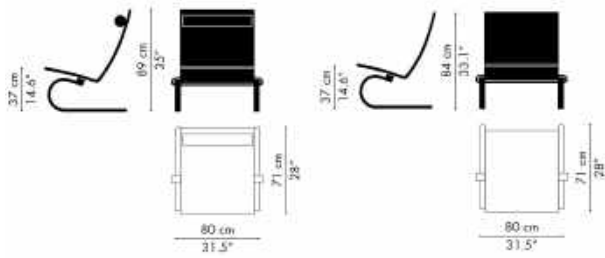



**PK22™**  
**POUL KJÆRHOLM 1956**

**01.2025**

The PK22™ lounge chair is available in wicker, canvas and a select range of leather types. The base is made of satin brushed stainless spring steel.

MODEL	DESCRIPTION	WICKER	CANVAS	CATEGORY 4	CATEGORY 5
PK22	Lounge chair, satin brushed stainless spring steel base	3.470	3.470	4.296	4.957

CATEGORY 4: AURA  
CATEGORY 5: GRACE, EMBRACE, NATURAL

CANVAS COLOURS - SEE THE SURFACE SELECTION  
NATURAL, BLACK

PK22

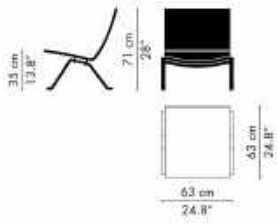



**PK24™**  
**POUL KJÆRHOLM 1965**

The PK24™ chaise longue is available in a select range of leather types or wicker. Both versions include a leather headrest. The base is made of satin brushed stainless spring steel.

MODEL	DESCRIPTION	CATEGORY 4	CATEGORY 5
PK24	Chaise longue, wicker, leather headrest, satin brushed stainless spring steel base	14.048	14.048
PK24	Chaise longue, leather, leather headrest, satin brushed stainless spring steel base	14.875	17.767

CATEGORY 4: AURA  
 CATEGORY 5: GRACE, EMBRACE, NATURAL

PK24

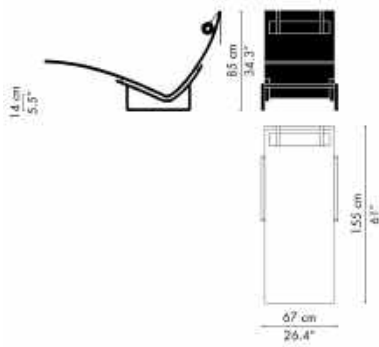



**PK25™**  
**POUL KJÆRHOLM 1951**

**01.2025**

The PK25™ lounge chair is available in flag halyard, in natural or black. The base is made of matt chromed spring steel.

MODEL	DESCRIPTION	FLAG HALYARD
PK25	Lounge chair, matt chromed spring steel base	10.329

FLAG HALYARD COLOURS - SEE THE SURFACE SELECTION  
NATURAL, BLACK

**PK25**

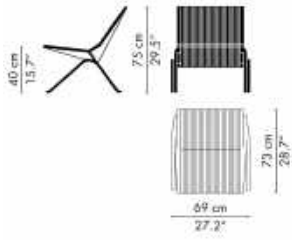



# PK26™ POUL KJÆRHOLM 1956

01.2025

The PK26™ is a wall-mounted modular sofa. The frame is made in matt chromed spring steel, and the cushion core is made of hairlok (natural fibres and latex). The sofa is upholstered in a select range of leather types and an exclusive leather type called Niger leather (special trading terms apply).

MODEL	DESCRIPTION	CATEGORY 4	CATEGORY 5
PK26	1-seater sofa, wall-mounted, matt chromed spring steel frame	15.701	18.594
PK26	2-seater sofa, wall-mounted, matt chromed spring steel frame	31.404	37.189

CATEGORY 4: AURA  
CATEGORY 5: GRACE, EMBRACE, NATURAL

PK26-1

PK26-2

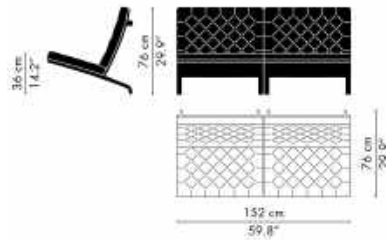
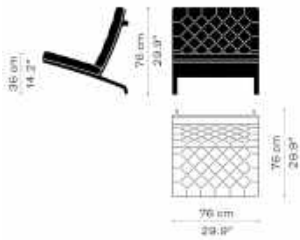



**PK31™**  
**POUL KJÆRHOLM 1958**

01.2025

The PK31™ series is available as a lounge chair and a 2- or 3-seater sofa. It comes in a select range of leather types. The frame is made of matt chromed spring steel. Additional modules can be added.

MODEL	DESCRIPTION	CATEGORY 4	CATEGORY 5
PK31	Lounge chair, matt chromed spring steel base	14.461	16.528
PK31/2	2-seater sofa, matt chromed spring steel base	24.379	27.685
PK31/3	3-seater sofa, matt chromed spring steel base	33.883	38.428
	Additional modules for PK31, matt chromed spring steel base	9.916	11.156

CATEGORY 4: AURA  
 CATEGORY 5: GRACE, EMBRACE, NATURAL

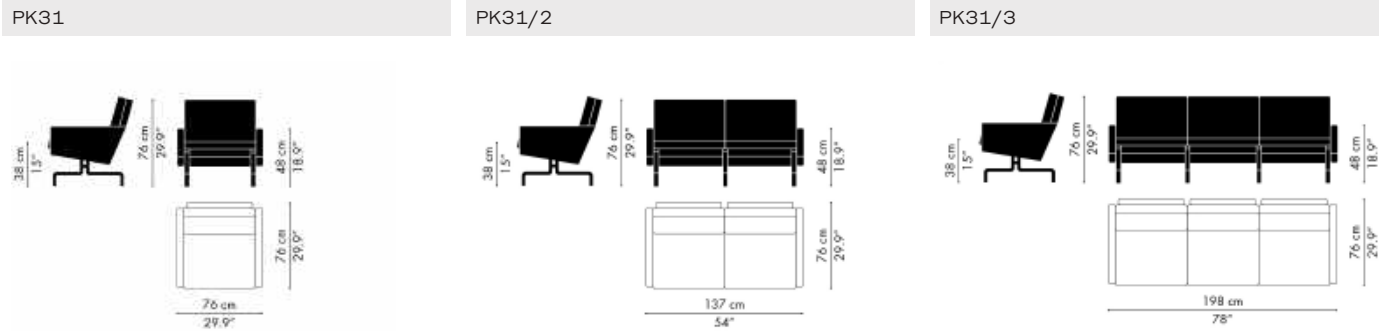



**PK33™**  
**POUL KJÆRHOLM 1959**

01.2025

The PK33™ stool is available with a detachable cushion in a select range of leather types or canvas. The three-legged stool has a matt chromed spring steel base.

MODEL	DESCRIPTION	CANVAS	CATEGORY 4	CATEGORY 5
PK33	Stool, matt chromed spring steel base	2.974	3.552	3.883

CATEGORY 4: AURA  
 CATEGORY 5: GRACE, EMBRACE, NATURAL

CANVAS COLOURS - SEE THE SURFACE SELECTION  
 NATURAL

PK33

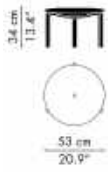



**PK80™**  
**POUL KJÆRHOLM 1957**

**01.2025**

The PK80™ daybed comes with a cushion upholstered in a select range of leather types as well as in canvas. It rests on a painted plywood bedplate, and the cushion core is made of granulated foam and hairlok (natural fibres and latex). The base is made of satin brushed stainless steel.

MODEL	DESCRIPTION	CANVAS	CATEGORY 4	CATEGORY 5
PK80	Daybed, satin brushed stainless steel base	10.329	15.288	17.354

CATEGORY 4: AURA  
 CATEGORY 5: GRACE, EMBRACE, NATURAL

CANVAS COLOURS - SEE THE SURFACE SELECTION  
 NATURAL

**PK80**

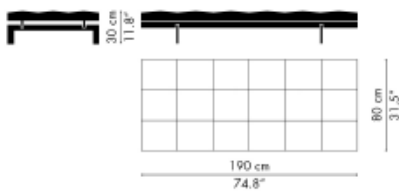





**PK81™**  
**POUL KJÆRHOLM 1959**

**01.2025**

The PK81™ daybed is a square version of the classic daybed PK80™. The base is made of satin brushed stainless steel and the daybed rests on a painted plywood bedplate. The cushion core is made of granulated foam and hairlok (natural fibres and latex) and comes upholstered in a select range of leather types as well as in an exclusive leather type called Buffalo leather (special trading terms apply).

MODEL	DESCRIPTION	CATEGORY 4	CATEGORY 5
PK81	Daybed, satin brushed stainless steel base	21.486	25.205

CATEGORY 4: AURA  
CATEGORY 5: GRACE, EMBRACE, NATURAL

PK81

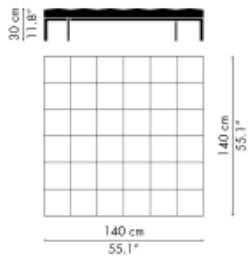



PK91™  
POUL KJÆRHOLM 1961

01.2025

The PK91™ folding stool is available with a seat in a select range of leather types as well as in canvas. The base is made of satin brushed stainless steel.

MODEL	DESCRIPTION	CANVAS	CATEGORY 4	CATEGORY 5
PK91	Folding stool, satin brushed stainless steel base	2.891	3.470	3.718

CATEGORY 4: AURA  
CATEGORY 5: GRACE, EMBRACE, NATURAL

CANVAS COLOURS - SEE THE SURFACE SELECTION  
NATURAL, BLACK

PK91

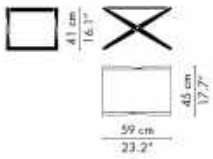



**PK40™**  
**POUL KJÆRHOLM 1980**

**01.2025**

The PK40™ table comes with an upholstered tabletop in a select range of leather types. The base is made in satin brushed stainless steel.

MODEL	DESCRIPTION	CATEGORY 4	CATEGORY 5	H/L/W
PK40	Table, satin brushed stainless steel base	15.288	22.313	70/140/140

CATEGORY 4: AURA  
CATEGORY 5: GRACE, EMBRACE, NATURAL

PK40

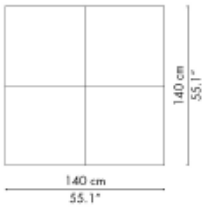



PK51™/PK55™  
POUL KJÆRHOLM 1957

01.2025

The PK51™ and PK55™ tables come with a tabletop in clear lacquered ash veneer. The bases are made of satin brushed stainless steel.

MODEL	DESCRIPTION	ASH	H/L/W
PK51	Table, satin brushed stainless steel base	8.015	72/204/102
PK55	Table, satin brushed stainless steel base	6.197	72/180/90

PK51

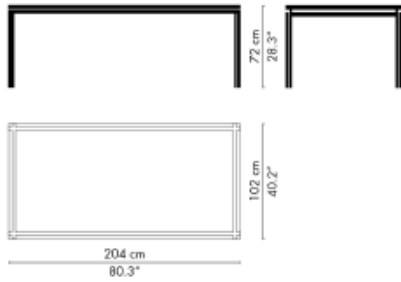

PK55

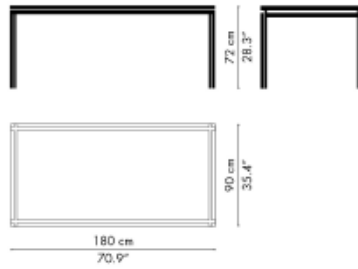



**PK54™/PK54A™**  
POUL KJÆRHOLM 1963

01.2025

The PK54™ table is available with a tabletop in marble or granite. The square base is made of satin brushed stainless steel. The circular table top has an optional expansion ring consisting of six sections including a storage rack, both made of natural, untreated solid maple.

MODEL	DESCRIPTION	MARBLE	GRANITE	FAUSKE MARBLE	H/Ø
PK54	Table, satin brushed stainless steel base	9.503	9.503	11.569	69/140

MARBLE COLOURS - SEE THE SURFACE SELECTION  
WHITE (HONED & ROLLED), BEIGE (HONED), GREY-BROWN (HONED) AND BLACK (HONED)

FAUSKE MARBLE - SEE THE SURFACE SELECTION  
GREY-WHITE (ROLLED)

NOTE  
THE MARBLE TABLETOPS ARE ALL UNIQUE WITH THEIR OWN PATTERN.

**EXPANSION RING**

MODEL	DESCRIPTION	SOLID MAPLE	
PK54A	Expansion ring, 6 sections, untreated solid maple, incl. storage rack	9.916	Ø210

PK54

PK54 +PK54A

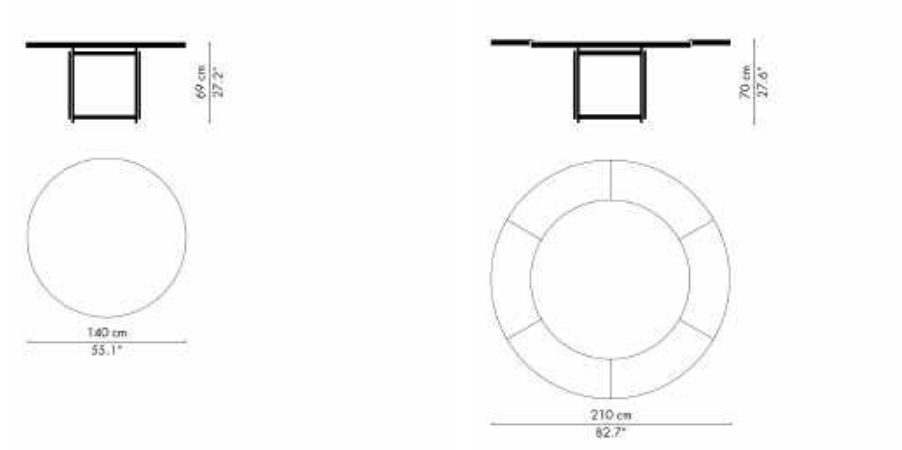



**PK58™**  
POUL KJÆRHOLM 1963/2007

01.2025

The PK58™ table comes with a white polyester composite tabletop. The square base is made of anodised satin brushed aluminium.

MODEL	DESCRIPTION	WHITE	H/Ø
PK58	Table, anodised satin brushed aluminium base	4.627	71/130

PK58

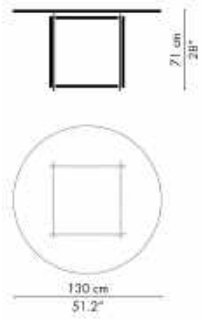



**PK60™**  
POUL KJÆRHOLM 1952

01.2025

The PK60™ coffee table comes with a circular tempered glass tabletop and a three-legged base in pressure moulded veneer. The base is available in two different finishes: Clear Lacquered Oregon Pine or black coloured ash.

MODEL	DESCRIPTION	BLACK COLOURED ASH	OREGON PINE	H/Ø
PK60	Coffee table, pressure moulded veneer base	2.478	2.726	44/105

PK60

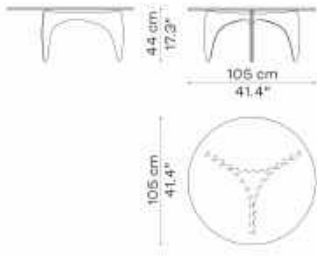



**PK61™/PK61A™**  
**POUL KJÆRHOLM 1956**

**01.2025**

The PK61™ coffee table is available with different tabletops; slate, marble, granite and glass. PK61A™ is an enlarged version of PK61™ and is available with tabletops in marble, granite and glass. The base for both tables is made of satin brushed stainless steel.

MODEL	DESCRIPTION	SLATE	MARBLE	GRANITE	GLASS	FAUSKE MARBLE	H/L/W
PK61	Coffee table, satin brushed stainless steel base	3.552	3.552	3.552	4.131	4.131	32/80/80
PK61A	Coffee table, satin brushed stainless steel base		5.701	5.701	6.114	6.114	32/120/120

**MARBLE COLOURS - SEE THE SURFACE SELECTION**  
 WHITE (HONED & ROLLED), BEIGE (HONED), GREY-BROWN (HONED) AND BLACK (HONED)

**FAUSKE MARBLE - SEE THE SURFACE SELECTION**  
 GREY-WHITE (ROLLED)

**NOTE**  
 THE MARBLE TABLETOPS ARE ALL UNIQUE WITH THEIR OWN PATTERN.

**PK61**

**PK61A**

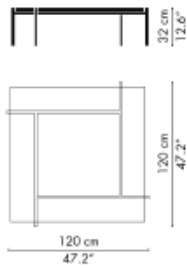
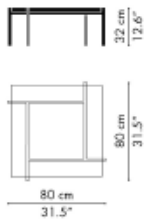





**PK62™**  
**POUL KJÆRHOLM 1968**

**01.2025**

The PK62™ side table is available with a tabletop in slate, marble or granite. The base is made of satin brushed stainless steel.

MODEL	DESCRIPTION	SLATE	MARBLE	GRANITE	FAUSKE MARBLE	H/L/W
PK62	Side table, satin brushed stainless steel	2.065	2.065	2.065	2.395	17/80/27

**MARBLE COLOUR** - SEE THE SURFACE SELECTION  
 WHITE (HONED & ROLLED), BEIGE (HONED), GREY-BROWN (HONED) AND BLACK (HONED)

**FAUSKE MARBLE** - SEE THE SURFACE SELECTION  
 GREY-WHITE (ROLLED)

**NOTE**  
 THE MARBLE TABLETOPS ARE ALL UNIQUE WITH THEIR OWN PATTERN.

**PK62**

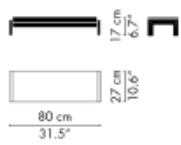



PK63™/PK63A™  
POUL KJÆRHOLM 1968

01.2025

The PK63™ and PK63A™ coffee tables are available with a tabletop in slate, marble or granite. The base is made of satin brushed stainless steel.

MODEL	DESCRIPTION	SLATE	MARBLE	GRANITE	FAUSKE MARBLE	H/L/W
PK63	Coffee table, satin brushed stainless steel base	4.379	4.379	4.379	5.288	31/180/60
PK63A	Coffee table, satin brushed stainless steel base	3.635	3.635	3.635	4.296	31/120/60

MARBLE COLOUR - SEE THE SURFACE SELECTION  
WHITE (HONED & ROLLED), BEIGE (HONED), GREY-BROWN (HONED) AND BLACK (HONED)

FAUSKE MARBLE - SEE THE SURFACE SELECTION  
GREY-WHITE (ROLLED)

NOTE  
THE MARBLE TABLETOPS ARE ALL UNIQUE WITH THEIR OWN PATTERN.

PK63

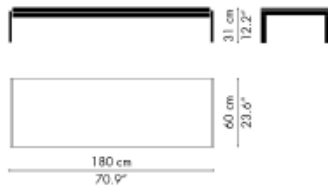

PK63A

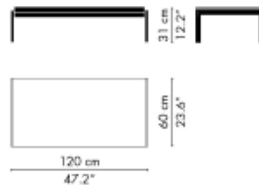



**PK65™**  
**POUL KJÆRHOLM 1979**

**01.2025**

The PK65™ coffee table is available with a tabletop in slate, marble, granite and glass. The base is made of satin brushed stainless steel.

MODEL	DESCRIPTION	SLATE	MARBLE	GRANITE	GLASS	FAUSKE MARBLE	H/L/W
PK65	Coffee table, satin brushed stainless steel base	4.379	4.379	4.379	5.205	5.205	38/100/100

MARBLE COLOUR - SEE THE SURFACE SELECTION  
 WHITE (HONED & ROLLED), BEIGE (HONED), GREY-BROWN (HONED) AND BLACK (HONED)

FAUSKE MARBLE - SEE THE SURFACE SELECTION  
 GREY-WHITE (ROLLED)

NOTE  
 THE MARBLE TABLETOPS ARE ALL UNIQUE WITH THEIR OWN PATTERN.

**PK65**

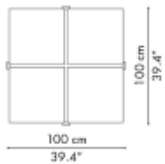

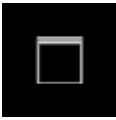

**PK71™**  
**POUL KJÆRHOLM 1957**

**01.2025**

The PK71™ nesting table consists of three tables with a white or black acrylic tabletop. The bases are made of satin brushed stainless steel.

MODEL	DESCRIPTION	WHITE, BLACK	H/L/W
PK71	Nesting table, 3 sizes, satin brushed stainless steel base	1.900	28.5/28/28

**PK71**

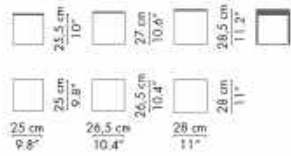

# SURFACE SELECTION

# SURFACE SELECTION

## INVENTORY

- 33 • Leather
- 34 • Wood
- 35 • Acrylic
  - Polyester Composite
  - Marble
- 36 • Granite
  - Slate
  - Glass
  - Metal
- 37 • Flag Halyard
  - Canvas
  - Wicker
  - French Cane

# SURFACE SELECTION

Colours and materials may vary from the images shown.  
Actual colour, gloss level and structure may vary.

## LEATHER

Please note that leather is a natural material with natural variation in colour and surface structure. The presence of scars and marks from bites etc. on the leather may occur and are characteristics of genuine leather.

### CUSTOMER'S OWN LEATHER (COL)

Customers can supply their own leather. Prices excluding leather as well as leather requirements can be given on inquiry. Please note that only very few types of leather/qualities are suitable. Fritz Hansen retains the right to reject the qualities we find unsuitable.

### SPECIAL LEATHER COLOURS

On inquiry and at a surcharge, special leather colours may be available for the models available with leather upholstery.

## AURA



BLACK

BLACK BROWN

COGNAC

WALNUT

PK8™  
PK9™  
PK11™  
PK20™  
PK22™  
PK24™  
PK26™  
PK31™  
PK33™  
PK40™  
PK80™  
PK81™  
PK91™

**CATEGORY: 4**  
Chrome-tanned, top-coated, strong full-grain and durable surface. Fast to light.  
Thickness 1.4-1.6 mm.

## EMBRACE

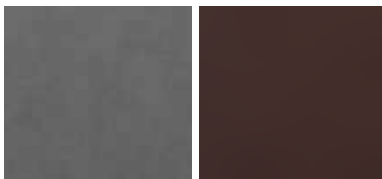

CONCRETE GREY

CHOCOLATE

PK9™  
PK11™  
PK20™  
PK22™  
PK24™  
PK26™  
PK31™  
PK33™  
PK40™  
PK80™  
PK81™  
PK91™

**CATEGORY: 5**  
Chrome-tanned, fully grained, extraordinary soft aniline with a special waxing giving a slightly 'oily' surface. Colour variations, visible natural markings e.g. Neck wrinkles.  
Thickness 1.2-1.4 mm.

## NATURAL



NATURAL

PK9™  
PK11™  
PK15™ (Seat cushion)  
PK20™  
PK22™  
PK24™  
PK26™  
PK31™  
PK33™  
PK40™  
PK80™  
PK81™  
PK91™

**CATEGORY: 5**  
Vegetable-tanned, chrome-free, natural leather, no colour or protective finish. Becomes darker and patinated with use, visible natural markings.  
Thickness 1.2-1.4 mm.

## GRACE



BLACK

DARK BROWN

WALNUT

CHESTNUT

PK4™ (Seat cushion)  
PK8™  
PK9™  
PK11™  
PK15™ (Seat cushion)  
PK20™  
PK22™  
PK24™  
PK26™  
PK31™  
PK33™  
PK40™  
PK80™  
PK81™  
PK91™

**CATEGORY: 5**  
Vegetable and chrome-tanned, aniline, full-grain with light structure and light impregnation. Becomes lighter and patinated with use, visible natural markings.  
Thickness 1.2-1.4 mm.

# SURFACE SELECTION

Colours and materials may vary from the images shown.  
Actual colour, gloss level and structure may vary.

## CLEAR LACQUERED VENEER



ASH  
PK51™  
PK55™



OREGON PINE  
PK0 A™  
PK60™

## COLOURED VENEER



ASH - BLACK  
PK0 A™  
PK60™

## CLEAR LACQUERED SOLID WOOD



ASH  
PK11™  
PK15™

## UNTREATED SOLID WOOD



MAPLE  
PK54A™ (Expansion ring)

## COLOURED SOLID WOOD



ASH - BLACK  
PK15™



# SURFACE SELECTION

Colours and materials may vary from the images shown.  
Actual colour, gloss level and structure may vary.

## ACRYLIC



WHITE  
PK71™

BLACK  
PK71™

## POLYESTER COMPOSITE

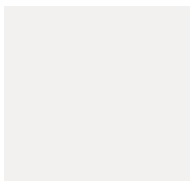

WHITE  
PK58™

## HONED MARBLE



WHITE  
PK54™  
PK61™  
PK61A™  
PK62™  
PK63™  
PK63A™  
PK65™

BEIGE  
PK54™  
PK61™  
PK61A™  
PK62™  
PK63™  
PK63A™  
PK65™

GREY-BROWN  
PK54™  
PK61™  
PK61A™  
PK62™  
PK63™  
PK63A™  
PK65™

BLACK  
PK54™  
PK61™  
PK61A™  
PK62™  
PK63™  
PK63A™  
PK65™

## ROLLED MARBLE



WHITE  
PK54™  
PK61™  
PK61A™  
PK62™  
PK63™  
PK63A™  
PK65™

GREY-WHITE  
PK54™  
PK61™  
PK61A™  
PK62™  
PK63™  
PK63A™  
PK65™

# SURFACE SELECTION

Colours and materials may vary from the images shown.  
Actual colour, gloss level and structure may vary.

## GRANITE



**DARK**

PK54™  
PK61™  
PK61A™  
PK62™  
PK63™  
PK63A™  
PK65™

## SLATE



**BLACK**

PK61™  
PK62™  
PK63™  
PK63A™  
PK65™

## GLASS



**CLEAR**

PK60™



**FLOAT**

PK61™  
PK61A™  
PK65™

## STEEL



**BRUSHED SPRING  
STEEL - MATT**

PK9™  
PK11™  
PK22™  
PK24™  
PK40™  
PK51™  
PK54™  
PK55™  
PK61™  
PK61A™  
PK62™  
PK63™  
PK63A™  
PK65™  
PK71™  
PK80™  
PK81™  
PK91™



**BRUSHED STAINLESS  
STEEL - MATT**

PK4™



**CHROMED SPRING  
STEEL - MATT**

PK20™  
PK25™  
PK26™  
PK31™  
PK33™

## POWDER COATED METAL (STEEL OR ALUMINIUM)



**BLACK**

PK4™

# SURFACE SELECTION

Colours and materials may vary from the images shown.  
Actual colour, gloss level and structure may vary.

## FLAG HALYARD

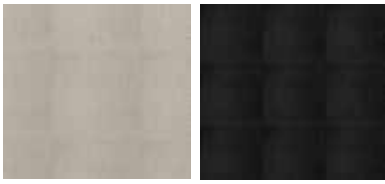

**NATURAL**  
100% FLAX WITH  
POLYESTER CORE

PK4™  
PK25™

**BLACK**  
100% FLAX WITH  
POLYESTER CORE

PK4™  
PK25™

## CANVAS



**NATURAL**  
100% COTTON

PK4™ (Seat cushion)  
PK22™  
PK33™  
PK80™  
PK91™

**BLACK**  
100% COTTON

PK4™ (Seat cushion)  
PK22™  
PK91™

## WICKER



**NATURAL**  
THICKNESS APPROX.  
2.5 MM AND 4.0 MM

PK20™  
PK22™  
PK24™

## FRENCH CANE



**NATURAL**

PK15™

# PRICE LIST 2025

## LIGHTING

EURO / VAT 21% / 01.2025

FRITZ HANSEN

# CONTENT

## 03 • GENERAL TERMS AND CONDITIONS

### LIGHTING

- 05 • AQ01™
- 06 • Avion™
- 07 • Caravaggio™
- 08 • Caravaggio™ Matt
- 09 • Caravaggio™ Opal
- 10 • Caravaggio™ Read
- 11 • Clam™
- 12 • Concert™
- 13 • KAISER idell™
- 14 • KAISER idell™
- 15 • KAISER idell™
- 16 • Maluma™
- 17 • MS Series
- 18 • Night Owl™
- 19 • Oneline™
- 20 • Orient™
- 21 • Suspence™

# GENERAL TERMS AND CONDITIONS

## CURRENCY & EFFECTIVE DATE

This price list is valid from 1 January 2025 and cancels all prior price lists.

Reservation is made for any errors and omissions. Furthermore, below general terms and conditions shall apply to all contracts under which Fritz Hansen A/S (Fritz Hansen) is the supplier/sub-supplier.

## ORDERING

Orders must be placed through Fritz Hansen's web-based order system called the Partner Portal ([www.fritzhansen.com](http://www.fritzhansen.com) - professional). Orders are not binding until the customer has received a written order confirmation from Fritz Hansen.

Price lists state the recommended retail price (RRP) or prices excl. VAT exclusive of freight and fees. All prices can be changed without notice. Changes to the collection such as discontinued products and/or items out of stock can occur even when stated differently in the price list. Updated information will be available on the partner portal only.

## ORDER CANCELLATION

Orders can be cancelled in accordance with the below rules:

	ORDERS CANCELLED 0-3 DAYS AFTER ORDER CONFIRMATION HAS BEEN SENT	ORDERS CANCELLED 3-14 DAYS AFTER ORDER CONFIRMATION HAS BEEN SENT
STANDARD PRODUCTS	FEE: NONE	FEE: 5% OF NET PRICE EXCL. VAT.
SPECIALS OR MODIFIED PRODUCTS	FEE: FULL PRICE	

Change and cancellation of order after 14 days from receipt of the order confirmation is not possible.

## DELIVERY

The following freight rates apply:

RATE	PER ORDER
EU+UK+NO+CH+US*	DKK 200 / € 55 / £ 50 / SEK 600 / NOK 550 / USD 55 EXCL. VAT.
REST OF THE WORLD	TO BE PICKED UP AT FRITZ HANSEN WAREHOUSES

For markets EU+UK+NO+CH+US free freight offered according to the following rates: Free shipping from DKK 3.000 / € 400 / £ 350 / SEK 4.500 / NOK 4.000 / USD 500 total order value excl. VAT.

\* For deliveries to outer areas such as islands in Portugal and Spain as well as Svalbard in Norway and others, a surcharge of DKK 420 / € 56 / £ 42 / NOK 580 per parcel will apply.

### Standard delivery terms:

- Denmark: DDP delivery address (INCO-Terms 2020)
- Countries within the EU: DDP delivery address (INCO-Terms 2020)
- European countries outside the EU: DAP delivery address (INCO-Terms 2020)
- USA: DDP delivery address (INCO-Terms 2020)
- Canada DAP delivery address (INCO-Terms 2020)
- Japan: DDP delivery address (INCO-Terms 2020)
- South Korea: DDP Fritz Hansen Busan (INCO-Terms 2020)
- Middle East, Asia, South and Central America, Australia: FCA Fritz Hansen warehouses in Denmark (INCO-Terms 2020)

For FCA: The goods must be picked up at the Fritz Hansen warehouses no later than 30 calendar days after the confirmed shipping date of the consolidated order. Address(es) for pickup will be specified on the commercial invoice. If the goods are not picked up, Fritz Hansen will charge the customer DKK 24 / € 3 / USD 4 per day per colli (all furniture orders are colli based) or pallet (all Lighting, Accessories, and Skagerak Collection orders are pallet based).

If the partner so desires, Fritz Hansen can deliver at the end user's address against an additional fee.

## CLAIMS

The physical product must be inspected upon delivery. Damage incurred in transit as well as any defects and deficiencies on the product incurred as a result of transportation must be recorded on the POD upon delivery. Fritz Hansen must be notified in writing of any claims about product defects and deficiencies within 48 hours of delivery. If the claims are made in due time and with the acceptance of Fritz Hansen, the customer is entitled to demand a replacement delivery or to have the defect remedied. The customer cannot demand a reduction or a compensation. Claims/replacements can only be made to the customer's address if delivery has not been made directly to the end user.

## TERMS OF PAYMENT

Terms of payment are 30 days net cash from invoice date. Invoices are issued and dated when the goods are dispatched. In case of late payment, interest will be charged at a rate of 1.5 % for every month or part thereof as from the due date. Interest invoices are payable net cash within eight days. Fritz Hansen can decide that the customer shall pay in advance, if the customer's balance is or has previously been due, or if the order amount exceeds the credit limit approved by Fritz Hansen.

## OBSERVATION OF TITLE

Title to the goods shall not pass to the customer until Fritz Hansen (or any third party to whom Fritz Hansen has assigned its rights to the purchase price) has received the full purchase price and been reimbursed any expenses incurred.

## WARRANTY

Fritz Hansen provides a standard five-year warranty on standard products within the collections Furniture and Skagerak Collection (Indoor & Outdoor) against defects in materials and workmanship. For the Arne Jacobsen shell chairs (Ant™, Grand Prix™, Lily™, Series 7™), the standard warranty is 10 years. Within the Furniture collection, an extended warranty of up to 10 years is provided on selected products, provided they have been registered online on [www.fritzhansen.com/my-fh](http://www.fritzhansen.com/my-fh) (see table on the next page for details).

Exception exists for AJ Children's Chairs, Series 7™ Junior, Series 7™ Cushion, Coat Tree™ Wall, Dot™, High Dot™ and AJ Trolley™ which are included in the Accessories warranty terms.

For the Poul Kjærholm collection, the standard warranty is 20 years except for PK0 A™ and PK60™, which is 10 years, and the PK15™, which is 5 years. Wicker and French Cane have a warranty of 2 years.

For the Lighting, Accessories and Skagerak Collection Accessories the standard warranty is 2 years. Specific for the Lighting category: Transformers, ballasts, light sources, and other electronic devices are subject to the warranty terms of the manufacturer in question. Fritz Hansen does not cover costs related to installation and dismantling, replacement of ballasts/transformers and other similar costs related to electricians and the like.

The warranty on all collections does not extend to ordinary tear, wear or damage to upholstery. On any material, textile, or leather which is not listed in our price lists configured on a specific product, the standard warranty is 2 years. The warranty is void upon subsequent changes to the product.

Additional warranty conditions can be found on [www.fritzhansen.com](http://www.fritzhansen.com).

## LIMITATION OF LIABILITY

Fritz Hansen will assume no liability for any loss as a result of delays, defects or any other breach of contract, unless such loss was caused by gross negligence on the part of Fritz Hansen. Fritz Hansen will assume no liability for any indirect loss, including loss of profits, operating loss, goodwill, loss of customers, running costs or any other consequential economic loss.

## CHOICE OF LAW AND JURISDICTION

Disputes between Fritz Hansen and its customers shall be subject to Danish law, except for the international civil law rules of Danish law, and shall be settled by Fritz Hansen's home court.

## MEASUREMENTS

The stated measurements act only as a guideline. The measurements can vary, and size difference on a product can occur.

## FORCE MAJURE

Fritz Hansen is without liability for non-performance of Fritz Hansen's obligations in respect to any orders received, if such non-performance is due to circumstances out of Fritz Hansen's reasonable control, which prevent the fulfilment of the purchase agreement or makes the fulfilment unreasonably burdensome. As examples of such circumstances the following can be mentioned: Industrial dispute and other circumstances which are beyond the control of the parties, such as fire, war, mobilization or calling in for military service of similar extent, requisition, seizure, exchange

controls, riots or disturbances, shortage of means of transportation, ordinary scarcity of goods, restrictions of motive power and defects in or late performance from sub-suppliers due to any of the aforementioned circumstances.

The above circumstances only lead to exemption from liability if their influence on the fulfilment of the purchase agreement could not be anticipated at the conclusion of the agreement. Fritz Hansen must without undue delay notify the customer in writing if any such circumstances, occurrence and cessation, if Fritz Hansen wishes to invoke any grounds of exemption from liability.

Regardless of what follows from these general conditions of sales and delivery, any party is entitled to terminate the purchase agreement by notifying the other party in writing, if the fulfilment of the agreement is prevented for more than 6 months due to one of the above circumstances.

Unless mandatory rules preclude this, Fritz Hansen is in no case liable to the customer for operating losses, lost earnings, or other financial consequential damages under these general conditions for sale and delivery.

## PRIVACY POLICY

At Fritz Hansen, confidentiality and data protection is a high priority. Guidelines for processing of personal data and description of the customer's and end users' rights according to applicable data protection law is governed by Fritz Hansen's privacy policy available on Fritz Hansen's website.

# WARRANTY OVERVIEW

Price list collections	Furniture Collection						Poul Kjærholm Collection				Skagerak Collection		Lighting Collection	Accessories Collection					
	Textiles, Cushions	Leather (1)	Leather (2)	Bases (3)	Bases (4)	Movable parts (5)	Ant <sup>™</sup> Grand Prix <sup>™</sup> , Lily <sup>™</sup> , Series 7 <sup>™</sup>	Shells, Tabletops	Tabletops (6)	China Chair <sup>™</sup>	French Cane, Wicker	PK15 <sup>™</sup>	PKO A <sup>™</sup> & PK60 <sup>™</sup>	Poul Kjærholm Collection	Outdoor	Indoor	Lighting	Accessories	Skagerak Collection
2 years										x							x	x	x
5 years	x	x		x		x					x			x	x				
10 years			x*		x*		x	x*				x**							
20 years									x**				x**						

1. Leather: Soft and Essential
2. Leather: Aura, Rustik, Natural, Grace and Embrace
3. Bases: Lacquered and Wooden (chairs), Powder coated (chairs and tables)
4. Bases: Aluminium, Chrome and Wooden (tables)
5. Movable parts: Automatic return, Tilt, Height-adjustable, Swivel, Castors and Extension mechanism
6. Tabletops: Lacquer under tabletop, Lacquer on edges and Surface on tabletop

\* Additional with registration on [www.fritzhansen.com/my-fh](http://www.fritzhansen.com/my-fh)

\*\* Standard without registration



**AQ01™**  
ANNE QVIST 2017

The AQ01™ has curvy edges and matt finish. The aluminium shade can be switched on, off and dimmed directly at the top. The diffuser prevents glare and gives off direct downward illumination in a symmetric rotational pattern. The delicate arms connecting the two joints hide the wire within and keep it in place with an internal spring. The AQ01™ can be configured as a plug-in, table lamp or wall mounted lamp.

SINGLE UNIT (FOR REPLACEMENT)

MODEL	COLOUR	CORD LGT. M	CORD SPECIFICATION	PRODUCT CODE	EXCL. VAT	INCL. VAT
AQ01 - LED	White	2,5	White, PVC + adapter	62698505	288	349
AQ01 - LED	Black	2,5	Black, PVC + adapter	62698408	288	349

PLUG-IN

MODEL	COLOUR	CORD LGT. M	CORD SPECIFICATION	PRODUCT CODE	EXCL. VAT	INCL. VAT
AQ01 + Plug-in	White	2,5	White, PVC + adapter	62716005	329	399
AQ01 + Plug-in	Black	2,5	Black, PVC + adapter	62716208	329	399

TABLE

MODEL	COLOUR	CORD LGT. M	CORD SPECIFICATION	PRODUCT CODE	EXCL. VAT	INCL. VAT
AQ01 + Table base	White	2,5	White, PVC + adapter	62699105	346	419
AQ01 + Table base	Black	2,5	Black, PVC + adapter	62699008	346	419

WALL

MODEL	COLOUR	CORD LGT. M	CORD SPECIFICATION	PRODUCT CODE	EXCL. VAT	INCL. VAT
AQ01 + Wall base	White	2,5	White, PVC + adapter	62698805	313	379
AQ01 + Wall base	Black	2,5	Black, PVC + adapter	62698708	313	379

PLUG-IN



TABLE



WALL







A childhood fascination with Zeppelin airships gliding with steady grace across the sky, inspired Iskos-Berlin to create Avion™. The large, oval pendant hovers playfully in the air, ready to change its direction to suit your desire. The pendant emits a soft, diffuse light that creates a cosy, natural atmosphere. Avion™ can be arranged in a regular formation, as a dynamic pack or similarly it can be suspended in a line to mark a passage through a building.

PENDANT

MODEL	COLOUR	CORD LGT. M	CORD SPECIFICATION	PRODUCT CODE	EXCL. VAT	INCL. VAT
2xE27	Polyethylene, white PC/ABS	6	White, PVC	54402705	676	819

TABLE/FLOOR

MODEL	COLOUR	CORD LGT. M	CORD SPECIFICATION	PRODUCT CODE	EXCL. VAT	INCL. VAT
2XE27	Polyethylene, white PC/ABS	6	Black, PVC	31000312	643	779

CANOPY

MODEL	COLOUR	PRODUCT CODE	EXCL. VAT	INCL. VAT
Adjustable canopy	White	18615605	222	269





**CARAVAGGIO™**  
**CECILIE MANZ 2005**

**01.2025**

The Caravaggio™ range of high-gloss pendants was launched in 2005 and instantly emerged as a design icon. The distinctive red cord and high-gloss aluminium shade surface clearly highlight one of the most striking pendant designs of the 2000s. The highly praised design by Cecilie Manz elegantly combines a recognisable shape with a modern expression.

**PENDANT**

MODEL	COLOUR	CORD LGT. M	CORD SPECIFICATION	CANOPY COLOUR	PRODUCT CODE	EXCL. VAT	INCL. VAT
P1	White	3	Grey, textile	White	54006905	271	329
P1	Black	3	Red, textile	White	54006708	271	329
P2	White	3	Grey, textile	White	54007005	371	449
P2	Black	3	Red, textile	White	54006808	371	449
P2	BlackBlack	3	Black, textile	Black	54007708	371	449
P3	White	6	Grey, textile	White	74009705	676	819
P3	Black	6	Red, textile	White	74009608	676	819
P3	BlackBlack	6	Black, textile	Black	54020208	676	819

**DIFFUSER**

MODEL	COLOUR	PRODUCT CODE	EXCL. VAT	INCL. VAT
P3	Opal	18173405	98	119

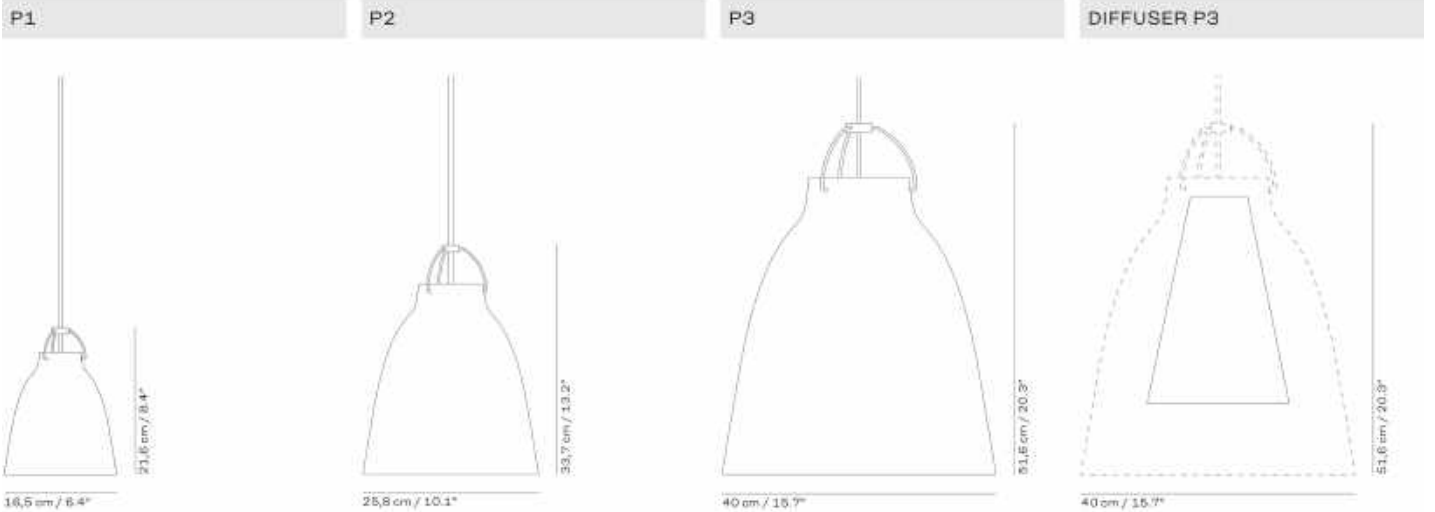



**CARAVAGGIO™ MATT**  
**CECILIE MANZ 2005**

01.2025

The completely matt finish adds a rare depth and tangibility that imbues the Caravaggio™ pendant with a warm, cosy feel. The delicate black, white and grey tones are carefully balanced and interact elegantly with each other. The tones from 2018 have their roots in nature's earthy hues: Warm Silk, Archipelago Stone, Dark Sienna and Dark Ultramarine. The discreet tones are timeless and suit virtually all settings.

PENDANT

MODEL	COLOUR	CORD LGT. M	CORD SPECIFICATION	CANOPY COLOUR	PRODUCT CODE	EXCL. VAT	INCL. VAT
P1	Patina Green	3	Grey25, textile	White	34000006	271	329
P1	Dusty Green	3	Grey25, textile	White	34000206	271	329
P1	Rusty red	3	Grey25, textile	White	34000401	271	329
P1	Warm grey	3	Grey25, textile	White	34000612	271	329
P1	White	3	White, textile	White	14031113	271	329
P1	Grey45	3	Grey45, textile	White	14035112	271	329
P1	Black	3	Grey45, textile	White	14037108	271	329
P2	Patina Green	3	Grey25, textile	White	34000106	371	449
P2	Dusty Green	3	Grey25, textile	White	34000306	371	449
P2	Rusty red	3	Grey25, textile	White	34000501	371	449
P2	Warm grey	3	Grey25, textile	White	34000712	371	449
P2	White	3	White, textile	White	14031213	371	449
P2	Black	3	Grey45, textile	White	14037208	371	449
P3	Warm grey	3	Grey25, textile	White	34000812	685	829
P3	White	6	White, textile	White	14032213	676	819
P3	Grey45	6	Grey45, textile	White	14036212	676	819
P3	Black	6	Grey45, textile	White	14038208	676	819

DIFFUSER

MODEL	COLOUR	PRODUCT CODE	EXCL. VAT	INCL. VAT
P3	Opal	18173405	98	119

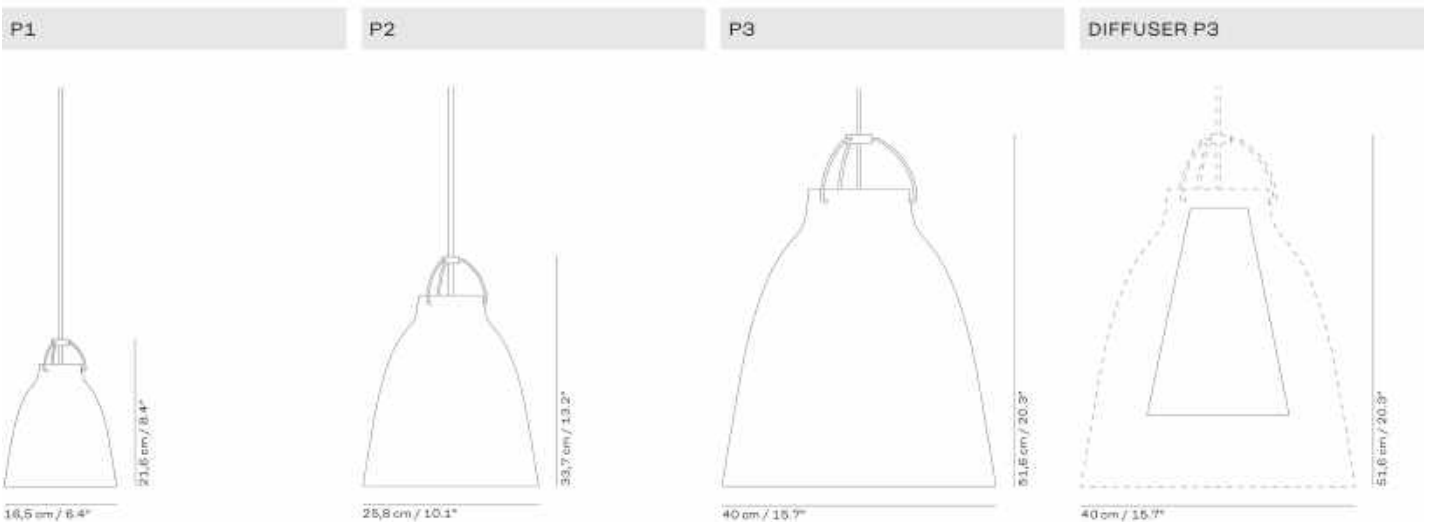



**CARAVAGGIO™ OPAL**  
**CECILIE MANZ 2005**

01.2025

With Caravaggio™ Opal, Cecilie Manz has combined the characteristic Caravaggio™ design with a completely different lighting effect. The opal glass shade emits a soft, dimmed light, which is particularly suitable for rooms where a more evocative lighting is required. The lamp is suspended by the three renowned shackles, which here form a raw and masculine contrast to the feminine opal hand-blown glass. The P0 comes with an integrated LED source.

PENDANT

MODEL	COLOUR	CORD LGT. M	CORD SPECIFICATION	CANOPY COLOUR	PRODUCT CODE	EXCL. VAT	INCL. VAT
P0 LED	Opal glass	3	Silver-grey, textile	White	94722705	247	299
P1	Opal glass	3	Silver-grey, textile	White	84183105	313	379
P2	Opal glass	3 w. wire	Silver-grey, textile	White	84183205	495	599
P3	Opal glass	6 w. wire	Silver-grey, textile	White	84184105	866	1.049

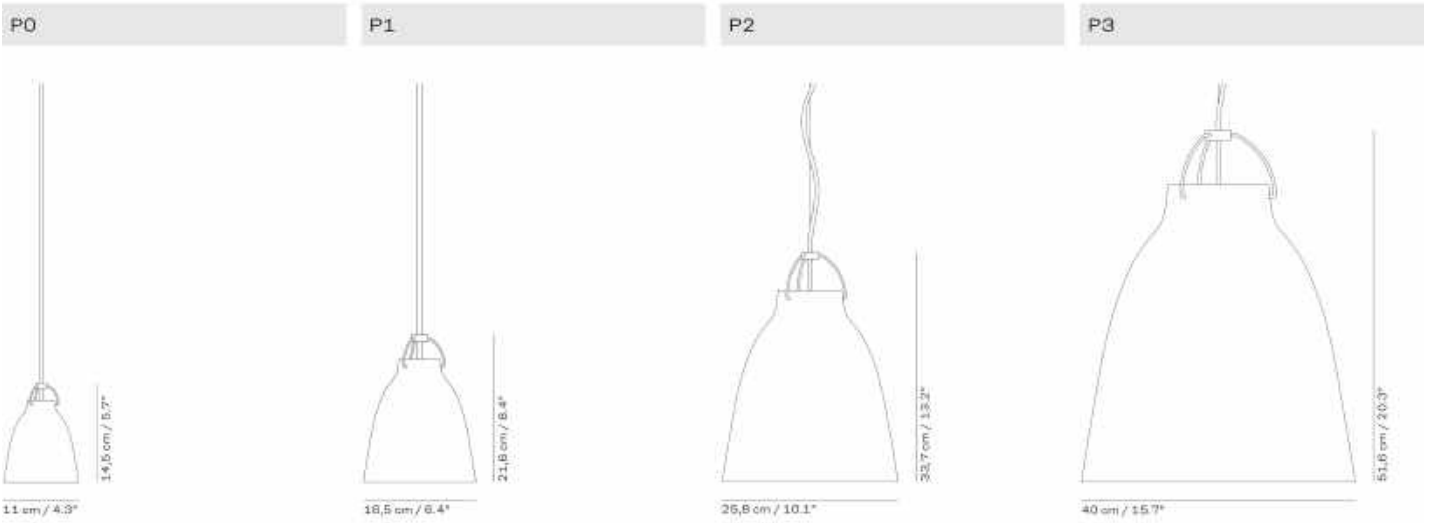



## CARAVAGGIO™ READ CECILIE MANZ 2005

01.2025

Based on the well-known Caravaggio™ shape, Cecilie Manz has created a functional reading wall lamp. The iconic shade comes either in matt lacquered aluminium or in opal glass and is installed on a flexible tube, allowing you to tilt the shade and direct the light. The lamps can be rotated for different needs. The Caravaggio™ Read is equipped with a three-level touch-control dimmer to enable adjustable light intensity. The switch is discreetly located on the underside of the wall mount for easy access.

WALL						
MODEL	COLOUR	CORD LGT. M	CORD SPECIFICATION	PRODUCT CODE	EXCL. VAT	INCL. VAT
White	White	1,5	White, PVC	23041405	304	369
Grey25	Grey25	1,5	Grey25, PVC	13041212	304	369
Black	Black	1,5	Black, PVC	23041308	304	369
Opal	Opal	1,5	Grey25, PVC	53403205	304	369

WALL

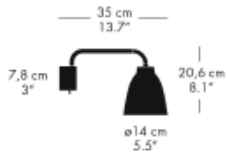



With beautiful, mouth-blown glass and brass details, the Clam™ pendant by Ahm & Lund is a new classic within lighting excellence. The Clam™ pendant lamp is inspired by a seashell and, like a shell hides its pearl, it 'hides' its light source. Its diffused light creates beautiful atmosphere and ambiance. The pendant is available in two sizes.

PENDANT

MODEL	COLOUR	CORD LGT. M	CORD SPECIFICATION	CANOPY COLOUR	PRODUCT CODE	EXCL. VAT	INCL. VAT
Ø440	Opal/brass	6	Black, textile	Brass	94724305	949	1.149
Ø550	Opal/brass	6	Black, textile	Brass	94722205	1.156	1.399

TABLE

MODEL	COLOUR	CORD LGT. M	CORD SPECIFICATION	PRODUCT CODE	EXCL. VAT	INCL. VAT
Table	Opal/brass	2	Black, textile	22000305	949	1.149

FLOOR

MODEL	COLOUR	CORD LGT. M	CORD SPECIFICATION	PRODUCT CODE	EXCL. VAT	INCL. VAT
Floor	Opal/brass	2	Black, textile	31000505	1.404	1.699

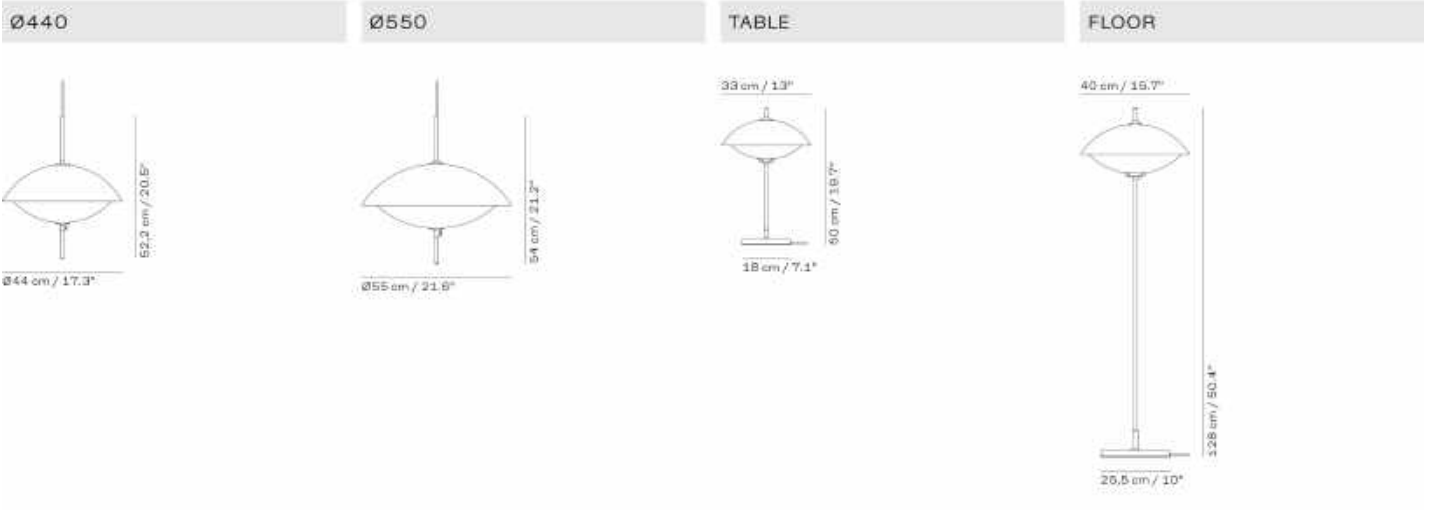



## CONCERT™ JØRN UTZON 2005

01.2025

Concert™ gives a pleasant, non-glaring light without compromising the strength of illumination. The chosen shade configuration is visually characteristic of Jørn Utzon and reminds us of his greatest work — the Sydney Opera House. Concert™ is designed with four shades and a parabola of drawn steel, resting on a glass cone suspension. The suspension unit sends out a pleasant, even light between the shades. The bottom shade casts light downward to the parabola, which then diffuses it.

### PENDANT

MODEL	COLOUR	CORD LGT. M	CORD SPECIFICATION	CANOPY COLOUR	PRODUCT CODE	EXCL. VAT	INCL. VAT
P1	White	3	White, textile	White	54003405	428	519
P1	Black	3	Black, textile	Black	14721808	428	519
P3	White	6 w. wire	White, textile	White	74003505	759	919
P3	Black	6 w. wire	Black, textile	Black	14721908	759	919

### PENDANT P1



### PENDANT P3

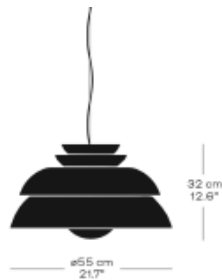



The renowned KAISER idell™ lamp series includes table, floor, wall and pendant lamps. The collection is characterised by Christian Dell's ability to create elegant design with basic geometric hallmarks of modernism: shapes like the sphere, circle and cylinder. Precisely engineered and with an exquisite choice of steel and brass materials, the series is recognized as a symbol of noble Bauhaus design. The KAISER idell™'s world-patented swivel joint and the characteristic dome embossed with "ORIGINAL KAISER-idell" serve as a true trademark for the timeless design classic.

PENDANT

MODEL	COLOUR	CORD LGT. M	CORD SPECIFICATION	CANOPY COLOUR	PRODUCT CODE	EXCL. VAT	INCL. VAT
6722-P	Matt black	3	Black, textile	Chrome	44000008	263	319
6722-P	White	3	Black, textile	Chrome	44000105	263	319
6722-P	Black	3	Black, textile	Silver	94721908	263	319
6722-P	Easy grey	3	Black, textile	Brass	14290812	263	319
6631-P	White	3	Black, textile	Silver	64700505	362	439
6631-P	Black	3	Black, textile	Silver	64700608	362	439
6631-P	Matt black	3	Black, textile	Silver	64700708	362	439
6631-P	Black Brass	3	Black, textile	Brass	14721208	362	439
6631-P	Venetian Red	3	Black, textile	Silver	24003003	362	439
6631-P	Olive green	3	Black, textile	Silver	24002905	362	439

WALL

MODEL	COLOUR	CORD LGT. M	CORD SPECIFICATION	PRODUCT CODE	EXCL. VAT	INCL. VAT
6559-W	Black	2	Black, textile	23000008	602	729
6559-W	White	2	Black, textile	23000105	602	729
6559-W	Matt black/brass	2	Black, textile	23000208	602	729
6718-W	White	2	White, textile	63702305	602	729
6718-W	Black	2	Black, textile	63702408	602	729
6718-W	Matt black	2	Black, textile	63702508	602	729
6718-W	Easy grey	2	Black, textile	13721612	602	729





TABLE

MODEL	COLOUR	CORD LGT. M	CORD SPECIFICATION	PRODUCT CODE	EXCL. VAT	INCL. VAT
6556-T	Venetian Red	2	Black, textile	22001503	561	679
6556-T	White	2	Black, textile	62702905	561	679
6556-T	Black	2	Black, textile	62703008	561	679
6556-T	Matt black	2	Black, textile	62703108	561	679
6556-T	Easy grey	2	Black, textile	12291112	561	679
6556-T	Venetian Red	2	Black, textile	22001503	561	679
6556-T	Olive green	2	Black, textile	22001405	561	679
6631-T Luxus	Venetian Red	2	Black, textile	42000001	701	849
6631-T Luxus	White	2	Black, textile	62701305	701	849
6631-T Luxus	Black	2	Black, textile	62701408	701	849
6631-T Luxus	Matt black	2	Black, textile	62701508	701	849
6631-T Luxus	Dark green	2	Black, textile	62701706	701	849
6631-T Luxus	Matt black/brass	2	Black, textile	92720908	701	849
6631-T Luxus	Easy grey, brass	2	Black, textile	92720912	701	849

FLOOR

MODEL	COLOUR	CORD LGT. M	CORD SPECIFICATION	PRODUCT CODE	EXCL. VAT	INCL. VAT
6556-F	Venetian Red	2	Black, textile	21000503	809	979
6556-F	White	2	Black, textile	61703505	809	979
6556-F	Black	2	Black, textile	61703608	809	979
6556-F	Matt black	2	Black, textile	61703708	809	979
6556-F	Easy grey, brass	2	Black, textile	91721012	809	979
6556-F	Venetian Red	2	Black, textile	21000503	809	979
6556-F	Olive green	2	Black, textile	21000405	809	979
6580-F Luxus	White	2	Black, textile	61704105	908	1.099
6580-F Luxus	Black	2	Black, textile	61704208	908	1.099
6580-F Luxus	Matt black	2	Black, textile	61704308	908	1.099
6580-F Luxus	Matt black/brass	2	Black, textile	11721008	908	1.099



6722-P



6631-P



6718-W

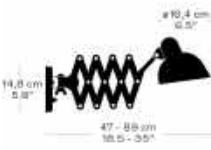

6559-W

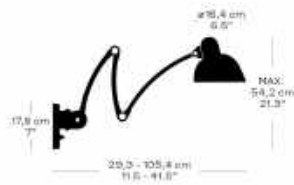

6556-T



6631-T LUXUS

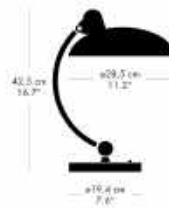

6556-F



6580-F LUXUS





## MALUMA™ FUMIE SHIBATA 2021

01.2025

The Maluma™ pendant comes with a hand-blown, frosted coloured glass shade, and a matching suspension. Available in delicate colours, the smoothly curved pendant adds a soft tone and modern expression to any environment. Off or illuminated, the Maluma™ retains its colour and provides both soft ambient light as well as functional downlight from its open underside.

### PENDANT

MODEL	COLOUR	CORD LGT. M	CORD SPECIFICATION	CANOPY COLOUR	PRODUCT CODE	EXCL. VAT	INCL. VAT
H350	Moss	3	Black, textile	Black	94723428	362	439
H350	Plum	3	Black, textile	Black	94723503	362	439
H350	Rose	3	Grey25, textile	White	94723601	362	439

### H350





**MS SERIES**  
**METTE SCHELDE 2023**

**01.2025**

The MS lamp series - a clean, cool and modern lighting collection consisting of one floor lamp and two table lamps designed to set the perfect mood. Created by contemporary Danish designer Mette Schelde, the Nordic inspired design casts a subtle pointed light, ideal for focused working, and have a dimmable function to suit different moods and needs.

**FLOOR**

MODEL	COLOUR	CORD LGT. M	CORD SPECIFICATION	PRODUCT CODE	EXCL. VAT	INCL. VAT
MS011	Steel	3	Black, silicone	31000120	949	1.149
MS011	Black PVD	3	Black, silicone	31000208	949	1.149

**TABLE**

MODEL	COLOUR	CORD LGT. M	CORD SPECIFICATION	PRODUCT CODE	EXCL. VAT	INCL. VAT
MS021	Steel	3	Black, silicone	32000320	577	699
MS021	Black PVD	3	Black, silicone	32000408	577	699
MS022	Steel	3	Black, silicone	32000520	461	559
MS022	Black PVD	3	Black, silicone	32000608	461	559

**MS011**



**MS021**

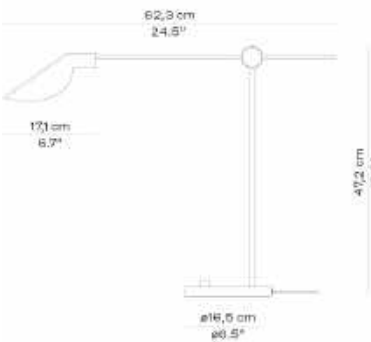

**MS022**





## NIGHT OWL™ NIKOLAI WIIG HANSEN 2015

01.2025

The Night Owl™ consists of a conical base and oval shade, merging together to form a single unit of balanced proportions. The matt lacquered aluminium shade is complemented by either a natural ash or an aluminium base with a colour that matches the shade. The organic design of the Night Owl™ gives the lamp a friendly and almost human appearance – a lamp with a personality. Night Owl™ is suitable for standing on e.g. a sideboard, shelf, bedside table or in a window.

### TABLE

MODEL	COLOUR	CORD LGT. M	CORD SPECIFICATION	PRODUCT CODE	EXCL. VAT	INCL. VAT
Night Owl	Midnight blue	2	Black, PVC	52698203	164	199
Night Owl	Smokey white	2	Black, PVC	52698305	164	199
Night Owl	Midnight blue/ash	2	Black, PVC	52698003	180	219
Night Owl	Smokey white/ash	2	Black, PVC	52698105	180	219
Night Owl Steel	Polished steel	2,5	Black, PVC	32000130	288	349
Night Owl Steel	Black PVD	2,5	Black, PVC	32000208	288	349

### TABLE





**ONELINE™**  
KASPER KJELDGAARD 2022

01.2025

Masterfully shaped as a slender beam of light, Oneline is offered in three different finishes. Available in stainless steel, brushed brass and black PVD, each has polished brass details and silver tone suspension cables. The design is fitted with long-lasting LED technology and is dimmable. Suspended above a kitchen counter, desk or dining table or hung in a hallway or hotel lobby, Oneline has the unique ability to blend in while standing out.

PENDANT

MODEL	COLOUR	CORD LGT. M	CORD SPECIFICATION	PRODUCT CODE	EXCL. VAT	INCL. VAT
OneLine Brass	Brass	12	Silver, wire	14290518	726	879
OneLine Steel	Steel	12	Silver, wire	14290600	726	879
OneLine Black	Black PVD	12	Silver, wire	14290708	726	879
OneLine Brass, Zigbee	Brass	12	Silver, wire	14291118	726	879
OneLine Steel, Zigbee	Steel	12	Silver, wire	14291200	726	879
OneLine Black, Zigbee	Black PVD	12	Silver, wire	14291308	726	879

CONNECTOR UNITS

MODEL	COLOUR	PRODUCT CODE	EXCL. VAT	INCL. VAT
Connector Unit	Brass	18631518	23	29
Connector Unit	Steel	18631600	23	29
Connector Unit	Black PVD	18631708	23	29

ONELINE

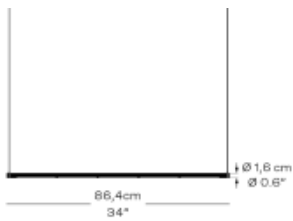



**ORIENT™**  
JO HAMMERBORG 1963

01.2025

Orient™ was designed by Jo Hammerborg in 1963 and relaunched by Fritz Hansen in 2013. Revitalized in close collaboration with the Hammerborg family, the Orient™ pendant is a flawless light design with excellent luminous efficacy, and is made from the finest quality materials. The pendant's organically shaped shade made of aluminium or copper is connected to the cord with a delicate wooden joint and gives a soft, pleasant light without any glare.

PENDANT

MODEL	COLOUR	CORD LGT. M	CORD SPECIFICATION	CANOPY COLOUR	PRODUCT CODE	EXCL. VAT	INCL. VAT
P1	Aluminium/oak	3	Grey, textile	White	84716372	321	389
P1	Black/ash	3	Black, textile	Black	34192108	304	369
P1	Copper/ash	3	Black, textile	Black	34192064	453	549
P2	Aluminium/oak	3	Grey, textile	White	84716472	486	589
P2	Black/ash	3	Black, textile	Black	34192308	453	549
P2	Copper/ash	3	Black, textile	Black	34192264	676	819
P3	Aluminium/oak	6	Grey, textile	White	84716572	767	929
P3	Black/ash	6	Black, textile	Black	34192808	742	899

PENDANT P1

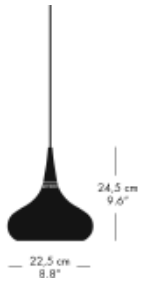

PENDANT P2

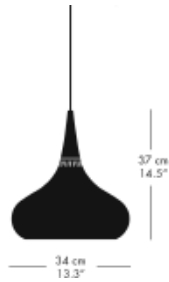

PENDANT P3

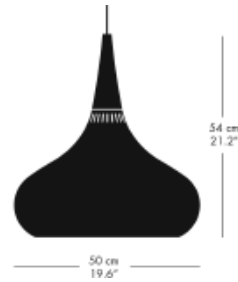



GamFratesi's inspiration for the Suspence™ pendant lamp series is translating a movement into a physical form and the shape of the lamp has been created by a soft pull, visually and physically connecting the cord with the shade. The infinity diffuser concentrates the light and prevents glare while creating an elegant optical illusion of infinite depth. The Suspence™ pendant comes with a matt lacquered aluminum shade and a colour-coordinated cord.

PENDANT

MODEL	COLOUR	CORD LGT. M	CORD SPECIFICATION	CANOPY COLOUR	PRODUCT CODE	EXCL. VAT	INCL. VAT
P1	White	3	White, PVC	White	54400205	304	369
P1	Light grey	3	Matt light grey, PVC	White	54400612	304	369
P1	Black	3	Black, PVC	Black	54400508	304	369
P1	Copper	3	Black, PVC	Black	54403364	470	569
P2	White	3	White, PVC	White	54400305	519	629
P2	Light grey	3	Matt light grey, PVC	White	54400812	519	629
P2	Black	3	Black, PVC	Black	54400708	519	629
P2	Copper	3 w. wire	Black, PVC	Black	54403564	949	1.149

PENDANT P1

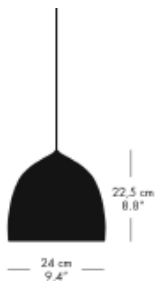

PENDANT P1.5

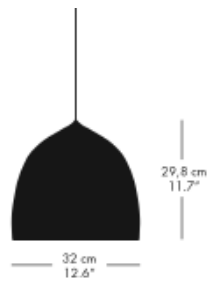

PENDANT P2

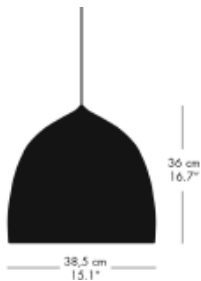

PENDANT P2 W. WIRE

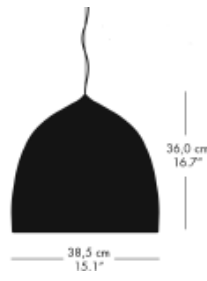



# PRICE LIST 2025

## ACCESSORIES

EURO / VAT 21% / 01.2025

FRITZ HANSEN

# CONTENT

## 03 • GENERAL TERMS AND CONDITIONS

### CANDLEHOLDERS

- 05 • Candleholder Single
- 06 • Candleholder Large

### CHILDREN'S CHAIRS

- 06 • Ant™ Children's Chair
- 07 • Grand Prix™ Children's Chair
- 08 • Lily™ Children's Chair
- 08 • Series 7™ Children's Chair
- 09 • Series 7™ Junior

### COAT HOOKS & STANDS

- 10 • Coat Tree™
- 10 • Coat Tree™ Wall
- 11 • Happy Hook

### CUSHIONS & THROWS

- 12 • Aiayu Cushion
- 12 • AJ Cushion
- 15 • Seat Cushion
- 16 • Cashmere Throw
- 16 • Classic Throw

### MIRRORS

- 16 • Mirror Long
- 16 • Mirror Oval
- 17 • Mirror Round

### POUFS

- 17 • Pouf Large
- 18 • Pouf Small

### RUGS & MATS

- 18 • Rugs

### SIDE TABLES

- 19 • AJ Trolley™
- 20 • Tray Table
- 20 • Tray Table Large

### STOOLS

- 21 • Dot™
- 22 • High Dot™ Counter Stool
- 24 • High Dot™ Bar Stool

### STORE & ORGANIZE

- 25 • Basket
- 25 • JH Tray

### VASES & POTS

- 25 • Ikebana Large
- 26 • Ikebana Small
- 26 • Ikebana Long
- 27 • Ikeru High
- 27 • Ikeru Low
- 28 • Moon Eye Vase

### OTHER

- 28 • Miniature Egg™
- 29 • Miniature Swan™
- 29 • Miniature Series 7™
- 30 • Rocking Horse

## SKAGERAK COLLECTION

### COAT HOOKS & STANDS

- 32 • Collar Hanger
- 32 • Pilot Coat Hanger

### CUTTING BOARDS & TRAYS

- 33 • Fionia Tray
- 34 • Norr Tray
- 34 • Nomad Table Tray
- 34 • Nomad Tray
- 35 • Dania Cutting Board
- 36 • Nordic Serving Tray
- 36 • No. 10 Tray
- 37 • Sild Tray
- 38 • Norr Carrier

### KITCHEN ACCESSORIES

- 38 • Norr Paper Towel Holder
- 38 • Hammer Grinder

### MIRRORS

- 39 • Aino Mirror

### RUGS & MATS

- 39 • Dania Mat

### STOOLS

- 40 • Dania Stool

### STORE & ORGANIZE

- 40 • Dania Box
- 41 • Dania Letter Tray
- 41 • Nomad Pen Holder
- 41 • Nomad Letter Tray
- 42 • Nomad Box

### VASES & POTS

- 42 • Edge Pot

### OTHER

- 43 • Stella Christmas Tree Base
- 44 • Beach Tennis

# GENERAL TERMS AND CONDITIONS

## CURRENCY & EFFECTIVE DATE

This price list is valid from 1 January 2025 and cancels all prior price lists.

Reservation is made for any errors and omissions. Furthermore, below general terms and conditions shall apply to all contracts under which Fritz Hansen A/S (Fritz Hansen) is the supplier/ sub-supplier.

## ORDERING

Orders must be placed through Fritz Hansen's web-based order system called the Partner Portal ([www.fritzhansen.com](http://www.fritzhansen.com) - professional). Orders are not binding until the customer has received a written order confirmation from Fritz Hansen.

Price lists state the recommended retail price (RRP) or prices excl. VAT exclusive of freight and fees. All prices can be changed without notice. Changes to the collection such as discontinued products and/or items out of stock can occur even when stated differently in the price list. Updated information will be available on the partner portal only.

## ORDER CANCELLATION

Orders can be cancelled in accordance with the below rules:

	ORDERS CANCELLED 0-3 DAYS AFTER ORDER CONFIRMATION HAS BEEN SENT	ORDERS CANCELLED 3-14 DAYS AFTER ORDER CONFIRMATION HAS BEEN SENT
STANDARD PRODUCTS	FEE: NONE	FEE: 5% OF NET PRICE EXCL. VAT.
SPECIALS OR MODIFIED PRODUCTS	FEE: FULL PRICE	

Change and cancellation of order after 14 days from receipt of the order confirmation is not possible.

## DELIVERY

The following freight rates apply:

RATE	PER ORDER
EU+UK+NO+CH+US*	DKK 200 / € 55 / £ 50 / SEK 600 / NOK 550 / USD 55 EXCL. VAT.
REST OF THE WORLD	TO BE PICKED UP AT FRITZ HANSEN WAREHOUSES

For markets EU+UK+NO+CH+US free freight offered according to the following rates: Free shipping from DKK 3.000 / € 400 / £ 350 / SEK 4.500 / NOK 4.000 / USD 500 total order value excl. VAT.

\* For deliveries to outer areas such as islands in Portugal and Spain as well as Svalbard in Norway and others, a surcharge of DKK 420 / € 56 / £ 42 / NOK 580 per parcel will apply.

### Standard delivery terms:

- Denmark: DDP delivery address (INCO-Terms 2020)
- Countries within the EU: DDP delivery address (INCO-Terms 2020)
- European countries outside the EU: DAP delivery address (INCO-Terms 2020)
- USA: DDP delivery address (INCO-Terms 2020)
- Canada DAP delivery address (INCO-Terms 2020)
- Japan: DDP delivery address (INCO-Terms 2020)
- South Korea: DDP Fritz Hansen Busan (INCO-Terms 2020)
- Middle East, Asia, South and Central America, Australia: FCA Fritz Hansen warehouses in Denmark (INCO-Terms 2020)

For FCA: The goods must be picked up at the Fritz Hansen warehouses no later than 30 calendar days after the confirmed shipping date of the consolidated order. Address(es) for pickup will be specified on the commercial invoice. If the goods are not picked up, Fritz Hansen will charge the customer DKK 24 / € 3 / USD 4 per day per colli (all furniture orders are colli based) or pallet (all Lighting, Accessories, and Skagerak Collection orders are pallet based).

If the partner so desires, Fritz Hansen can deliver at the end user's address against an additional fee.

## CLAIMS

The physical product must be inspected upon delivery. Damage incurred in transit as well as any defects and deficiencies on the product incurred as a result of transportation must be recorded on the POD upon delivery. Fritz Hansen must be notified in writing of any claims about product defects and deficiencies within 48 hours of delivery. If the claims are made in due time and with the acceptance of Fritz Hansen, the customer is entitled to demand a replacement delivery or to have the defect remedied. The customer cannot demand a reduction or a compensation. Claims/replacements can only be made to the customer's address if delivery has not been made directly to the end user.

## TERMS OF PAYMENT

Terms of payment are 30 days net cash from invoice date. Invoices are issued and dated when the goods are dispatched. In case of late payment, interest will be charged at a rate of 1.5 % for every month or part thereof as from the due date. Interest invoices are payable net cash within eight days. Fritz Hansen can decide that the customer shall pay in advance, if the customer's balance is or has previously been due, or if the order amount exceeds the credit limit approved by Fritz Hansen.

## OBSERVATION OF TITLE

Title to the goods shall not pass to the customer until Fritz Hansen (or any third party to whom Fritz Hansen has assigned its rights to the purchase price) has received the full purchase price and been reimbursed any expenses incurred.

## WARRANTY

Fritz Hansen provides a standard five-year warranty on standard products within the collections Furniture and Skagerak Collection (Indoor & Outdoor) against defects in materials and workmanship. For the Arne Jacobsen shell chairs (Ant™, Grand Prix™, Lily™, Series 7™), the standard warranty is 10 years. Within the Furniture collection, an extended warranty of up to 10 years is provided on selected products, provided they have been registered online on [www.fritzhansen.com/my-fh](http://www.fritzhansen.com/my-fh) (see table on the next page for details).

Exception exists for AJ Children's Chairs, Series 7™ Junior, Series 7™ Cushion, Coat Tree™ Wall, Dot™, High Dot™ and AJ Trolley™ which are included in the Accessories warranty terms.

For the Poul Kjærholm collection, the standard warranty is 20 years except for PK0 A™ and PK60™, which is 10 years, and the PK15™, which is 5 years. Wicker and French Cane have a warranty of 2 years.

For the Lighting, Accessories and Skagerak Collection Accessories the standard warranty is 2 years. Specific for the Lighting category: Transformers, ballasts, light sources, and other electronic devices are subject to the warranty terms of the manufacturer in question. Fritz Hansen does not cover costs related to installation and dismantling, replacement of ballasts/transformers and other similar costs related to electricians and the like.

The warranty on all collections does not extend to ordinary tear, wear or damage to upholstery. On any material, textile, or leather which is not listed in our price lists configured on a specific product, the standard warranty is 2 years. The warranty is void upon subsequent changes to the product.

Additional warranty conditions can be found on [www.fritzhansen.com](http://www.fritzhansen.com).

## LIMITATION OF LIABILITY

Fritz Hansen will assume no liability for any loss as a result of delays, defects or any other breach of contract, unless such loss was caused by gross negligence on the part of Fritz Hansen. Fritz Hansen will assume no liability for any indirect loss, including loss of profits, operating loss, goodwill, loss of customers, running costs or any other consequential economic loss.

## CHOICE OF LAW AND JURISDICTION

Disputes between Fritz Hansen and its customers shall be subject to Danish law, except for the international civil law rules of Danish law, and shall be settled by Fritz Hansen's home court.

## MEASUREMENTS

The stated measurements act only as a guideline. The measurements can vary, and size difference on a product can occur.

## FORCE MAJURE

Fritz Hansen is without liability for non-performance of Fritz Hansen's obligations in respect to any orders received, if such non-performance is due to circumstances out of Fritz Hansen's reasonable control, which prevent the fulfilment of the purchase agreement or makes the fulfilment unreasonably burdensome. As examples of such circumstances the following can be mentioned: Industrial dispute and other circumstances which are beyond the control of the parties, such as fire, war, mobilization or calling in for military service of similar extent, requisition, seizure, exchange

controls, riots or disturbances, shortage of means of transportation, ordinary scarcity of goods, restrictions of motive power and defects in or late performance from sub-suppliers due to any of the aforementioned circumstances.

The above circumstances only lead to exemption from liability if their influence on the fulfilment of the purchase agreement could not be anticipated at the conclusion of the agreement. Fritz Hansen must without undue delay notify the customer in writing if any such circumstances, occurrence and cessation, if Fritz Hansen wishes to invoke any grounds of exemption from liability.

Regardless of what follows from these general conditions of sales and delivery, any party is entitled to terminate the purchase agreement by notifying the other party in writing, if the fulfilment of the agreement is prevented for more than 6 months due to one of the above circumstances.

Unless mandatory rules preclude this, Fritz Hansen is in no case liable to the customer for operating losses, lost earnings, or other financial consequential damages under these general conditions for sale and delivery.

## PRIVACY POLICY

At Fritz Hansen, confidentiality and data protection is a high priority. Guidelines for processing of personal data and description of the customer's and end users' rights according to applicable data protection law is governed by Fritz Hansen's privacy policy available on Fritz Hansen's website.

# WARRANTY OVERVIEW

Price list collections	Furniture Collection						Poul Kjærholm Collection				Skagerak Collection		Lighting Collection	Accessories Collection					
	Textiles, Cushions	Leather (1)	Leather (2)	Bases (3)	Bases (4)	Movable parts (5)	Ant <sup>™</sup> Grand Prix <sup>™</sup> , Lily <sup>™</sup> , Series 7 <sup>™</sup>	Shells, Tabletops	Tabletops (6)	China Chair <sup>™</sup>	French Cane, Wicker	PK15 <sup>™</sup>	PK0 A <sup>™</sup> & PK60 <sup>™</sup>	Poul Kjærholm Collection	Outdoor	Indoor	Lighting	Accessories	Skagerak Collection
2 years										x							x	x	x
5 years	x	x		x		x		x			x			x	x				
10 years			x*		x*		x	x*				x**							
20 years									x**				x**						

1. Leather: Soft and Essential
2. Leather: Aura, Rustik, Natural, Grace and Embrace
3. Bases: Lacquered and Wooden (chairs), Powder coated (chairs and tables)
4. Bases: Aluminium, Chrome and Wooden (tables)
5. Movable parts: Automatic return, Tilt, Height-adjustable, Swivel, Castors and Extension mechanism
6. Tabletops: Lacquer under tabletop, Lacquer on edges and Surface on tabletop

\* Additional with registration on [www.fritzhansen.com/my-fh](http://www.fritzhansen.com/my-fh)

\*\* Standard without registration

## CANDLEHOLDER SINGLE #1 JAIME HAYON

DESCRIPTION	EXCL. VAT	INCL. VAT
Candleholder	65	79



MATERIALS: Lacquered solid brass  
DIMENSIONS: Diameter 5 cm, height 10,5 cm  
COLLI: 8  
ITEM NO.: 840092



## CANDLEHOLDER SINGLE #1 JAIME HAYON

DESCRIPTION	EXCL. VAT	INCL. VAT
Candleholder	65	79



MATERIALS: Stainless steel  
DIMENSIONS: Diameter 5 cm, height 10,5 cm  
COLLI: 8  
ITEM NO.: 840089



## CANDLEHOLDER SINGLE #2 JAIME HAYON

DESCRIPTION	EXCL. VAT	INCL. VAT
Candleholder	73	89



MATERIALS: Lacquered solid brass  
DIMENSIONS: Diameter 4 cm, height 13 cm  
COLLI: 8  
ITEM NO.: 840091



## CANDLEHOLDER SINGLE #2 JAIME HAYON

DESCRIPTION	EXCL. VAT	INCL. VAT
Candleholder	73	89



MATERIALS: Stainless steel  
DIMENSIONS: Diameter 4 cm, height 13 cm  
COLLI: 8  
ITEM NO.: 840088



## CANDLEHOLDER LARGE JAIME HAYON

DESCRIPTION	EXCL. VAT	INCL. VAT
Candleholder	180	219



MATERIALS: Stainless steel  
 DIMENSIONS: Diameter 16 cm, height 20 cm  
 COLLI: 2  
 ITEM NO.: 840087



## CANDLEHOLDER LARGE JAIME HAYON

DESCRIPTION	EXCL. VAT	INCL. VAT
Candleholder	180	219



MATERIALS: Lacquered solid brass  
 DIMENSIONS: Diameter 16 cm, height 20 cm  
 COLLI: 2  
 ITEM NO.: 840090



## ANT™ CHILDREN'S CHAIR ARNE JACOBSEN

DESCRIPTION	EXCL. VAT	INCL. VAT
Children's chair	263	319



MATERIALS: Coloured ash veneer, chromed steel  
 COLOUR: Midnight blue  
 DIMENSIONS: Width 40 cm, height 60 cm, seat height 34 cm  
 COLLI: 1  
 ITEM NO.: 840224



## ANT™ CHILDREN'S CHAIR ARNE JACOBSEN

DESCRIPTION	EXCL. VAT	INCL. VAT
Children's chair	263	319



MATERIALS: Coloured ash veneer, chromed steel  
 COLOUR: Wild Rose  
 DIMENSIONS: Width 40 cm, height 60 cm, seat height 34 cm  
 COLLI: 1  
 ITEM NO.: 840225



ANT™ CHILDREN'S CHAIR ARNE JACOBSEN

DESCRIPTION	EXCL. VAT	INCL. VAT
Children's chair	263	319



MATERIALS: Coloured ash veneer, chromed steel  
 COLOUR: Oregon Pine  
 DIMENSIONS: Width 40 cm, height 60 cm, seat height 34 cm  
 COLLI: 1  
 ITEM NO.: 840226



GRAND PRIX™ CHILDREN'S CHAIR ARNE JACOBSEN

DESCRIPTION	EXCL. VAT	INCL. VAT
Children's chair	263	319



MATERIALS: Coloured ash veneer, chromed steel  
 COLOUR: Midnight blue  
 DIMENSIONS: Width 40 cm, height 60 cm, seat height 34 cm  
 COLLI: 1  
 ITEM NO.: 840221



GRAND PRIX™ CHILDREN'S CHAIR ARNE JACOBSEN

DESCRIPTION	EXCL. VAT	INCL. VAT
Children's chair	263	319



MATERIALS: Coloured ash veneer, chromed steel  
 COLOUR: Wild Rose  
 DIMENSIONS: Width 40 cm, height 60 cm, seat height 34 cm  
 COLLI: 1  
 ITEM NO.: 840222



GRAND PRIX™ CHILDREN'S CHAIR ARNE JACOBSEN



DESCRIPTION	EXCL. VAT	INCL. VAT
Children's chair	263	319





MATERIALS: Coloured ash veneer, chromed steel  
 COLOUR: Oregon Pine  
 DIMENSIONS: Width 40 cm, height 60 cm, seat height 34 cm  
 COLLI: 1  
 ITEM NO.: 840223





## LILY™ CHILDREN'S CHAIR ARNE JACOBSEN

DESCRIPTION		EXCL. VAT	INCL. VAT
Children's chair		263	319
	<p>MATERIALS: Coloured ash veneer, chromed steel            COLOUR: Midnight blue            DIMENSIONS: Width 40 cm, height 60 cm, seat height 34 cm            COLLI: 1            ITEM NO.: 840243</p>	 5 702370 002091	



## LILY™ CHILDREN'S CHAIR ARNE JACOBSEN

DESCRIPTION		EXCL. VAT	INCL. VAT
Children's chair		263	319
	<p>MATERIALS: Coloured ash veneer, chromed steel            COLOUR: Wild Rose            DIMENSIONS: Width 40 cm, height 60 cm, seat height 34 cm            COLLI: 1            ITEM NO.: 840242</p>	 5 702370 002107	

## LILY™ CHILDREN'S CHAIR ARNE JACOBSEN

DESCRIPTION		EXCL. VAT	INCL. VAT
Children's chair		263	319
	<p>MATERIALS: Coloured ash veneer, chromed steel            COLOUR: Midnight blue            DIMENSIONS: Width 40 cm, height 60 cm, seat height 34 cm            COLLI: 1            ITEM NO.: 840241</p>	 5 702370 002114	

## SERIES 7™ CHILDREN'S CHAIR ARNE JACOBSEN

DESCRIPTION		EXCL. VAT	INCL. VAT
Children's chair		263	319
	<p>MATERIALS: Coloured ash veneer, chromed steel            COLOUR: Midnight blue            DIMENSIONS: Width 40 cm, height 60 cm, seat height 34 cm            COLLI: 1            ITEM NO.: 840227</p>	 5 702370 002077	



**SERIES 7™ CHILDREN'S CHAIR** ARNE JACOBSEN

DESCRIPTION	EXCL. VAT	INCL. VAT
Children's chair	263	319



MATERIALS: Coloured ash veneer, chromed steel  
 COLOUR: Wild Rose  
 DIMENSIONS: Width 40 cm, height 60 cm, seat height 34 cm  
 COLLI: 1  
 ITEM NO.: 840228



**SERIES 7™ CHILDREN'S CHAIR** ARNE JACOBSEN

DESCRIPTION	EXCL. VAT	INCL. VAT
Children's chair	263	319



MATERIALS: Coloured ash veneer, chromed steel  
 COLOUR: Oregon Pine  
 DIMENSIONS: Width 40 cm, height 60 cm, seat height 34 cm  
 COLLI: 1  
 ITEM NO.: 840229



**SERIES 7™ JUNIOR** ARNE JACOBSEN

DESCRIPTION	EXCL. VAT	INCL. VAT
Junior chair	313	379



MATERIALS: Coloured ash veneer, chromed steel  
 COLOUR: Black  
 DIMENSIONS: Width 42 cm, depth 44 cm, height 79 cm, seat height 52 cm  
 COLLI: 1  
 ITEM NO.: 840236



**SERIES 7™ JUNIOR** Arne Jacobsen



DESCRIPTION	EXCL. VAT	INCL. VAT
Junior chair	313	379





MATERIALS: Natural oak veneer, chromed steel  
 COLOUR: Oak  
 DIMENSIONS: Width 42 cm, depth 44 cm, height 79 cm, seat height 52 cm  
 COLLI: 1  
 ITEM NO.: 840237



**SERIES 7™ JUNIOR** ARNE JACOBSEN

DESCRIPTION		EXCL. VAT	INCL. VAT
Junior Chair		313	379
	<p>MATERIALS: Coloured ash veneer, Brown Bronze powder coated steel            COLOUR: Burnt Yellow            DIMENSIONS: Width 42 cm, depth 44 cm, height 79 cm, seat height 52 cm            COLLI: 1            ITEM NO.: 840238</p>		 5 702370 000301



**SERIES 7™ JUNIOR** ARNE JACOBSEN

DESCRIPTION		EXCL. VAT	INCL. VAT
Junior Chair		313	379
	<p>MATERIALS: Coloured ash veneer, Brown Bronze powder coated steel            COLOUR: Evergreen            DIMENSIONS: Width 42 cm, depth 44 cm, height 79 cm, seat height 52 cm            COLLI: 1            ITEM NO.: 840239</p>		 5 702370 000318



**COAT TREE™** SIDSE WERNER

DESCRIPTION		EXCL. VAT	INCL. VAT
Coat hanger		1.114	1.349
	<p>MATERIALS: Steel, plastic            COLOUR: Chrome            DIMENSIONS: Diameter 65 cm, height 193 cm            COLLI: 1            ITEM NO.: 840332</p>		 5 702370 000646



**COAT TREE™ WALL** SIDSE WERNER

DESCRIPTION		EXCL. VAT	INCL. VAT
Coat hanger		321	389
	<p>MATERIALS: Powder coated steel, plastic            COLOUR: Light grey / grey knobs            DIMENSIONS: Width 46 cm, length 30 cm, height 104 cm            COLLI: 1            ITEM NO.: 840330            NOTE: Max load per arm: 8 kg. (Not responsible for how the product is mounted on the wall).</p>		 5 704890 403303



# COAT TREE™ WALL SIDSE WERNER

DESCRIPTION		EXCL. VAT	INCL. VAT
Coat hanger		321	389
	<p>MATERIALS: Powder coated steel, plastic            COLOUR: Dark blue / black knobs            DIMENSIONS: Width 46 cm, length 30 cm, height 104 cm            COLLI: 1            ITEM NO.: 840331            NOTE: Max load per arm: 8 kg. (Not responsible for how the product is mounted on the wall).</p>		 5 704890 403310



## HAPPY HOOK Jaime Hayon

DESCRIPTION		EXCL. VAT	INCL. VAT
Hook		52	64
	<p>MATERIALS: Painted steel            COLOUR: Blush            DIMENSIONS: Width 15 cm, depth 6.5 cm, length 13 cm            COLLI: 4            ITEM NO.: 850411</p>		 5 704890 504116



## HAPPY HOOK Jaime Hayon

DESCRIPTION		EXCL. VAT	INCL. VAT
Hook		52	64
	<p>MATERIALS: Painted steel            COLOUR: Turquoise            DIMENSIONS: Width 15 cm, depth 6.5 cm, length 13 cm            COLLI: 4            ITEM NO.: 850412</p>		 5 704890 504123



## HAPPY HOOK Jaime Hayon

DESCRIPTION		EXCL. VAT	INCL. VAT
Hook		52	64
	<p>MATERIALS: Painted steel            COLOUR: Green grey            DIMENSIONS: Width 15 cm, depth 6.5 cm, length 13 cm            COLLI: 4            ITEM NO.: 850413</p>		 5 704890 504130



## HAPPY HOOK JAIME HAYON

DESCRIPTION		EXCL. VAT	INCL. VAT
Hook		98	119
 <p> <b>MATERIALS:</b> Brass  <b>COLOUR:</b> Brass  <b>DIMENSIONS:</b> Width 15 cm, depth 6.5 cm, length 13 cm  <b>COLL:</b> 4  <b>ITEM NO.:</b> 850421         </p>			 5 702370 001063

## CUSHION AIAYU

DESCRIPTION		EXCL. VAT	INCL. VAT
Cushion		123	149
 <p> <b>MATERIALS:</b> Baby llama wool and linen, down filling  <b>COLOUR:</b> Anthracite  <b>DIMENSIONS:</b> Width 60 cm, height 40 cm  <b>COLL:</b> 4  <b>ITEM NO.:</b> 840025         </p>			 5 704890 400258



## CUSHION AIAYU

DESCRIPTION		EXCL. VAT	INCL. VAT
Cushion		123	149
 <p> <b>MATERIALS:</b> Baby llama wool and linen, down filling  <b>COLOUR:</b> Oat  <b>DIMENSIONS:</b> Width 60 cm, height 40 cm  <b>COLL:</b> 4  <b>ITEM NO.:</b> 840026         </p>			 5 704890 400265

## CUSHION VERTIGO ARNE JACOBSEN

DESCRIPTION		EXCL. VAT	INCL. VAT
Cushion		123	149
 <p> <b>MATERIALS:</b> Wool, Fossflakes™ filling  <b>COLOUR:</b> Light grey  <b>DIMENSIONS:</b> Width 50 cm, height 50 cm  <b>COLL:</b> 4  <b>PATTERN:</b> Vertigo  <b>ITEM NO.:</b> 840012         </p>			 5 704890 400128

## CUSHION VERTIGO ARNE JACOBSEN

DESCRIPTION		EXCL. VAT	INCL. VAT
Cushion		123	149
 <p> <b>MATERIALS:</b> Wool, Fossflakes™ filling  <b>COLOUR:</b> Light grey  <b>DIMENSIONS:</b> Width 60 cm, height 40 cm  <b>COLL:</b> 4  <b>PATTERN:</b> Vertigo  <b>ITEM NO.:</b> 840022                 </p>			 5 704890 400227

## CUSHION TRAPEZ ARNE JACOBSEN

DESCRIPTION		EXCL. VAT	INCL. VAT
Cushion		123	149
 <p> <b>MATERIALS:</b> Wool, Fossflakes™ filling  <b>COLOUR:</b> Midnight blue  <b>DIMENSIONS:</b> Width 50 cm, height 50 cm  <b>COLL:</b> 4  <b>PATTERN:</b> Trapez  <b>ITEM NO.:</b> 840019                 </p>			 5 704890 400197

## CUSHION TRAPEZ ARNE JACOBSEN

DESCRIPTION		EXCL. VAT	INCL. VAT
Cushion		123	149
 <p> <b>MATERIALS:</b> Wool, Fossflakes™ filling  <b>COLOUR:</b> Midnight blue  <b>DIMENSIONS:</b> Width 60 cm, height 40 cm  <b>COLL:</b> 4  <b>PATTERN:</b> Trapez  <b>ITEM NO.:</b> 840029                 </p>			 5 704890 400296



## CUSHION TRAPEZ ARNE JACOBSEN

DESCRIPTION		EXCL. VAT	INCL. VAT
Cushion		123	149
 <p> <b>MATERIALS:</b> Wool, Fossflakes™ filling  <b>COLOUR:</b> Earth Brown  <b>DIMENSIONS:</b> Width 50 cm, height 50 cm  <b>COLL:</b> 4  <b>PATTERN:</b> Trapez  <b>ITEM NO.:</b> 840425                 </p>			 5 704890 404256

## CUSHION TRAPEZ ARNE JACOBSEN

DESCRIPTION	EXCL. VAT	INCL. VAT
Cushion	123	149

	MATERIALS: Wool, Fossflakes™ filling COLOUR: Earth Brown DIMENSIONS: Width 60 cm, height 40 cm COLL: 4 PATTERN: Trapez ITEM NO.: 840426	 5 704890 404263
--	--	--

## CUSHION VERTIGO ARNE JACOBSEN

DESCRIPTION	EXCL. VAT	INCL. VAT
Cushion	123	149

	MATERIALS: Wool, Fossflakes™ filling COLOUR: Sand DIMENSIONS: Width 50 cm, height 50 cm COLL: 4 PATTERN: Vertigo ITEM NO.: 840427	 5 704890 404270
--	--	--

## CUSHION VERTIGO ARNE JACOBSEN

DESCRIPTION	EXCL. VAT	INCL. VAT
Cushion	123	149

  

	MATERIALS: Wool, Fossflakes™ filling COLOUR: Sand DIMENSIONS: Width 60 cm, height 40 cm COLL: 4 PATTERN: Vertigo ITEM NO.: 840428	 5 704890 404287
--	--	--



## CUSHION TASSEL ARNE JACOBSEN

DESCRIPTION	EXCL. VAT	INCL. VAT
Cushion	114	139



  

	MATERIALS: Wool, Fossflakes™ filling COLOUR: Pale Green DIMENSIONS: Width 45 cm, height 45 cm COLL: 4 PATTERN: Tassel ITEM NO.: 840429	 5 704890 404294
--	---	--



## CUSHION TASSEL ARNE JACOBSEN

DESCRIPTION		EXCL. VAT	INCL. VAT
Cushion		114	139
 <p> <b>MATERIALS:</b> Wool, Fossflakes™ filling  <b>COLOUR:</b> Pale Green  <b>DIMENSIONS:</b> Width 56 cm, height 36 cm  <b>COLL:</b> 4  <b>PATTERN:</b> Tassel  <b>ITEM NO.:</b> 840430                 </p>			 5 704890 404300



## SEAT CUSHION FRITZ HANSEN

DESCRIPTION		EXCL. VAT	INCL. VAT
Seat cushion		98	119
 <p> <b>MATERIALS:</b> Wild leather  <b>COLOUR:</b> Walnut  <b>DIMENSIONS:</b> Width 49 cm, length 39 cm.  <b>COLL:</b> 4  <b>ITEM NO.:</b> 840161                 </p>			 5 704890 401613



## SEAT CUSHION FRITZ HANSEN

DESCRIPTION		EXCL. VAT	INCL. VAT
Seat cushion		65	79
 <p> <b>MATERIALS:</b> Raw leather  <b>COLOUR:</b> Black  <b>DIMENSIONS:</b> Width 49 cm, length 39 cm.  <b>COLL:</b> 4  <b>ITEM NO.:</b> 840160                 </p>			 5 704890 401606



## SEAT CUSHION FRITZ HANSEN

DESCRIPTION		EXCL. VAT	INCL. VAT
Seat cushion		65	79
 <p> <b>MATERIALS:</b> Intense leather  <b>COLOUR:</b> Brown  <b>DIMENSIONS:</b> Width 49 cm, length 39 cm.  <b>COLL:</b> 4  <b>ITEM NO.:</b> 840162                 </p>			 5 704890 401620

## CASHMERE THROW FRITZ HANSEN

DESCRIPTION		EXCL. VAT	INCL. VAT
Throw		346	419
	<p>MATERIALS: 80% Cashmere, 20% Superfine Merino wool            COLOUR: Natural brown            DIMENSIONS: Width 120 cm, Length 190 cm            COLLI: 2            ITEM NO.: 840002</p>		 5 704890 400029



## CLASSIC THROW FRITZ HANSEN

DESCRIPTION		EXCL. VAT	INCL. VAT
Throw		123	149
	<p>MATERIALS: 100% fine Merino wool            COLOUR: Grey            DIMENSIONS: Width 130, length 180 cm            COLLI: 2            ITEM NO.: 840007</p>		 5 704890 400074

## MIRROR LONG STUDIO ROSO

DESCRIPTION		EXCL. VAT	INCL. VAT
Mirror		866	1.049
	<p>MATERIALS: Printed reflective glass, lacquered MDF            COLOUR: Pink            DIMENSIONS: Width 38 cm, height 161 cm            COLLI: 1            ITEM NO.: 840300</p>		 5 704890 403006

## MIRROR OVAL STUDIO ROSO



DESCRIPTION		EXCL. VAT	INCL. VAT
Mirror		784	949
	<p>MATERIALS: Printed reflective glass, lacquered MDF            COLOUR: Ocean            DIMENSIONS: Width 56 cm, height 84 cm            COLLI: 1            ITEM NO.: 840310</p>		 5 704890 403105





## MIRROR ROUND STUDIO ROSO

DESCRIPTION		EXCL. VAT	INCL. VAT
Mirror		809	979
	<p>MATERIALS: Printed reflective glass, lacquered MDF            COLOUR: Green            DIMENSIONS: Diameter 76 cm            COLLI: 1            ITEM NO.: 840320</p>		 5 704890 403204



## POUF LARGE CECILIE MANZ

DESCRIPTION		EXCL. VAT	INCL. VAT
Pouf		428	519
	<p>MATERIALS: Remix, canvas, leather piping            COLOUR: Concrete            DIMENSIONS: Diameter 60 cm, height 29 cm            COLLI: 1            ITEM NO.: 840170</p>		 5 704890 400890

## POUF LARGE Cecilie Manz

DESCRIPTION		EXCL. VAT	INCL. VAT
Pouf		428	519
	<p>MATERIALS: Wool, linen, leather piping            COLOUR: Indigo            DIMENSIONS: Diameter 60 cm, height 29 cm            COLLI: 1            ITEM NO.: 840299</p>		 5 704890 402993

## POUF LARGE CECILIE MANZ

DESCRIPTION		EXCL. VAT	INCL. VAT
Pouf		428	519
	<p>MATERIALS: Twill weave, canvas, leather piping            COLOUR: Beige            DIMENSIONS: Diameter 60 cm, height 29 cm            COLLI: 1            ITEM NO.: 840421</p>		 5 704890 402993

## POUF SMALL CECILIE MANZ

DESCRIPTION	EXCL. VAT	INCL. VAT
Pouf	470	569



MATERIALS: Buffed leather, canvas, leather piping  
 COLOUR: Grey  
 DIMENSIONS: Diameter 50 cm, height 24 cm  
 COLLI: 1  
 ITEM NO.: 840423



## POUF SMALL Cecilie Manz

DESCRIPTION	EXCL. VAT	INCL. VAT
Pouf	362	439



MATERIALS: Hallingdal, canvas, leather piping  
 COLOUR: Ultramarine  
 DIMENSIONS: Diameter 50 cm, height 24 cm  
 COLLI: 1  
 ITEM NO.: 840298



## POUF SMALL CECILIE MANZ

DESCRIPTION	EXCL. VAT	INCL. VAT
Pouf	362	439



MATERIALS: Remix, canvas, leather piping  
 COLOUR: Slate  
 DIMENSIONS: Diameter 50 cm, height 24 cm  
 COLLI: 1  
 ITEM NO.: 840178



## RUG DOTS Cecilie Manz



DESCRIPTION	EXCL. VAT	INCL. VAT
Rug	1.073	1.299



MATERIALS: 100% wool  
 COLOUR: Beige / black  
 DIMENSIONS: Width 150 cm, length 190 cm  
 COLLI: 1  
 ITEM NO.: 840400



## RUG BALANCE Cecilie Manz

DESCRIPTION		EXCL. VAT	INCL. VAT
Rug		511	619
	<p>MATERIALS: 100% wool            COLOUR: Black / beige / pale yellow            DIMENSIONS: Width 103 cm, length 130 cm            COLLI: 1            ITEM NO.: 840401</p>		5 704890 404010



## RUG DOTTED BALANCE Cecilie Manz



DESCRIPTION		EXCL. VAT	INCL. VAT
Rug		511	619
	<p>MATERIALS: 100% wool            COLOUR: Beige / black            DIMENSIONS: Width 103 cm, length 130 cm            COLLI: 1            ITEM NO.: 840402</p>		5 704890 404027

## RUG OCHRE Cecilie Manz



DESCRIPTION		EXCL. VAT	INCL. VAT
Rug		511	619
	<p>MATERIALS: 100% wool            COLOUR: Black / ochre / grey            DIMENSIONS: Width 103 cm, length 130 cm            COLLI: 1            ITEM NO.: 840403</p>		5 704890 404034

## AJ TROLLEY™ Arne Jacobsen



DESCRIPTION		EXCL. VAT	INCL. VAT
Small table		676	819
	<p>MATERIALS: Brushed stainless steel, MDF, coloured ash veneer            COLOUR: Black            DIMENSIONS: Width 67 cm, depth 59 cm, height 54,7 cm            COLLI: 1            ITEM NO.: 840410</p>		5 704890 404102

DESCRIPTION		EXCL. VAT	INCL. VAT
Small table		742	899
	<p>MATERIALS: Brushed stainless steel, MDF, clear lacquered walnut veneer            COLOUR: Walnut            DIMENSIONS: Width 67 cm, depth 59 cm, height 54,7 cm            COLLI: 1            ITEM NO.: 840412</p>		 5 702370 002626



TRAY TABLE FRITZ HANSEN

DESCRIPTION		EXCL. VAT	INCL. VAT
Foldable tray table		470	569
	<p>MATERIALS: Veneer, solid wood base, oiled oak            COLOUR: Oak            DIMENSIONS: Diameter 45 cm, height 42 cm            COLLI: 2            ITEM NO.: 840120</p>		 5 704890 401200

TRAY TABLE FRITZ HANSEN

DESCRIPTION		EXCL. VAT	INCL. VAT
Foldable tray table		470	569
	<p>MATERIALS: Veneer, solid wood base, lacquered oak            COLOUR: Black            DIMENSIONS: Diameter 45 cm, height 42 cm            COLLI: 2            ITEM NO.: 840121</p>		 5 704890 401217

TRAY TABLE LARGE FRITZ HANSEN

DESCRIPTION		EXCL. VAT	INCL. VAT
Foldable tray table		594	719
	<p>MATERIALS: Veneer, solid wood base, lacquered oak            COLOUR: Black            DIMENSIONS: Diameter 60 cm, height 39 cm            COLLI: 2            ITEM NO.: 840122</p>		 5 704890 401224

## TRAY TABLE LARGE Fritz Hansen

DESCRIPTION	EXCL. VAT	INCL. VAT
Foldable tray table	594	719



MATERIALS: Veneer, solid wood base, oiled oak  
 COLOUR: Oak  
 DIMENSIONS: Diameter 60 cm, height 39 cm  
 COLLI: 2  
 ITEM NO.: 840124



## DOT™ ARNE JACOBSEN

DESCRIPTION	EXCL. VAT	INCL. VAT
Stool	222	269



MATERIALS: Walnut veneer, chromed base  
 COLOUR: Walnut  
 DIMENSIONS: Diameter 34 cm, height 46 cm  
 COLLI: 1  
 ITEM NO.: 840132



## DOT™ ARNE JACOBSEN

DESCRIPTION	EXCL. VAT	INCL. VAT
Stool	222	269



MATERIALS: Colored ash, chromed base  
 COLOUR: Black  
 DIMENSIONS: Diameter 34 cm, height 46 cm  
 COLLI: 1  
 ITEM NO.: 840128



## DOT™ ARNE JACOBSEN

DESCRIPTION	EXCL. VAT	INCL. VAT
Stool	271	329



MATERIALS: Wild leather, chromed steel  
 COLOUR: Walnut  
 DIMENSIONS: Diameter 34 cm, height 46 cm  
 COLLI: 1  
 ITEM NO.: 840100



DOT™ ARNE JACOBSEN

DESCRIPTION	EXCL. VAT	INCL. VAT
Stool	271	329



MATERIALS: Intense leather, powder-coated steel  
 COLOUR: Black matt  
 DIMENSIONS: Diameter 34 cm, height 46 cm  
 COLLI: 1  
 ITEM NO.: 840105



HIGH DOT™ COUNTER STOOL ARNE JACOBSEN

DESCRIPTION	EXCL. VAT	INCL. VAT
Counter Stool 3-Legs	354	429



MATERIALS: Intense leather, powder coated steel  
 COLOUR: Black matt  
 DIMENSIONS: Diameter 44 cm, height 65 cm  
 COLLI: 1  
 ITEM NO.: 840106



HIGH DOT™ COUNTER STOOL ARNE JACOBSEN

DESCRIPTION	EXCL. VAT	INCL. VAT
Counter Stool 3-Legs	354	429



MATERIALS: Wild leather, chromed steel  
 COLOUR: Walnut  
 DIMENSIONS: Diameter 44 cm, height 65 cm  
 COLLI: 1  
 ITEM NO.: 840107



HIGH DOT™ COUNTER STOOL ARNE JACOBSEN

DESCRIPTION	EXCL. VAT	INCL. VAT
Counter Stool 3-Legs	304	369



MATERIALS: Walnut veneer, chromed base  
 COLOUR: Walnut  
 DIMENSIONS: Diameter 34 cm, height 65 cm  
 COLLI: 1  
 ITEM NO.: 840133



## HIGH DOT™ COUNTER STOOL ARNE JACOBSEN

DESCRIPTION	EXCL. VAT	INCL. VAT
Counter Stool 3-Legs	304	369



MATERIALS: Colored ash, chromed base  
 COLOUR: Black  
 DIMENSIONS: Diameter 34 cm, height 65 cm  
 COLLI: 1  
 ITEM NO.: 840129



## HIGH DOT™ COUNTER STOOL ARNE JACOBSEN

DESCRIPTION	EXCL. VAT	INCL. VAT
Counter Stool 4-Legs	304	369



MATERIALS: Walnut veneer, chromed base  
 COLOUR: Walnut  
 DIMENSIONS: Diameter 34 cm, height 65 cm  
 COLLI: 1  
 ITEM NO.: 840134



## HIGH DOT™ COUNTER STOOL ARNE JACOBSEN

DESCRIPTION	EXCL. VAT	INCL. VAT
Counter Stool 4-Legs	304	369



MATERIALS: Colored ash, chromed base  
 COLOUR: Black  
 DIMENSIONS: Diameter 34 cm, height 65 cm  
 COLLI: 1  
 ITEM NO.: 840130



## HIGH DOT™ COUNTER STOOL ARNE JACOBSEN

DESCRIPTION	EXCL. VAT	INCL. VAT
Counter Stool 4-Legs	346	419



MATERIALS: Intense leather, black, powdercoated steel  
 COLOUR: Black matt  
 DIMENSIONS: Diameter 34 cm, height 65 cm  
 COLLI: 1  
 ITEM NO.: 840136



## HIGH DOT™ COUNTER STOOL ARNE JACOBSEN

DESCRIPTION	EXCL. VAT	INCL. VAT
Counter Stool 4-Legs	346	419



MATERIALS: Wild leather, walnut, chromed steel  
 COLOUR: Walnut  
 DIMENSIONS: Diameter 34 cm, height 65 cm  
 COLLI: 1  
 ITEM NO.: 840138



## HIGH DOT™ BAR STOOL ARNE JACOBSEN

DESCRIPTION	EXCL. VAT	INCL. VAT
Bar stool 4-legs	304	369



MATERIALS: Walnut veneer, chromed base  
 COLOUR: Walnut  
 DIMENSIONS: Diameter 34 cm, height 76 cm  
 COLLI: 1  
 ITEM NO.: 840135



## HIGH DOT™ BAR STOOL ARNE JACOBSEN

DESCRIPTION	EXCL. VAT	INCL. VAT
Bar stool 4-legs	304	369



MATERIALS: Colored ash, chromed base  
 COLOUR: Black  
 DIMENSIONS: Diameter 34 cm, height 76 cm  
 COLLI: 1  
 ITEM NO.: 840131



## HIGH DOT™ BAR STOOL ARNE JACOBSEN

DESCRIPTION	EXCL. VAT	INCL. VAT
Bar stool 4-legs	346	419





MATERIALS: Intense leather, black, powdercoated steel  
 COLOUR: Black matt  
 DIMENSIONS: Diameter 34 cm, height 76 cm  
 COLLI: 1  
 ITEM NO.: 840137









## HIGH DOT™ BAR STOOL ARNE JACOBSEN

DESCRIPTION		EXCL. VAT	INCL. VAT
Bar stool 4-legs		346	419
	<p>MATERIALS: Wild leather, walnut, chromed steel            COLOUR: Walnut            DIMENSIONS: Diameter 34 cm, height 76 cm            COLL: 1            ITEM NO.: 840139</p>		 5 702370 002275



## BASKET BENJAMIN HUBERT

DESCRIPTION		EXCL. VAT	INCL. VAT
Basket		180	219
	<p>MATERIALS: Lacquered ash veneer, steam bent ash            DIMENSIONS: Width 37 cm, length 53 cm, height 36,5 cm            COLL: 2            ITEM NO.: 840240</p>		 5 704890 402405

## JH TRAY JAIME HAYON

DESCRIPTION		EXCL. VAT	INCL. VAT
Tray		280	339
	<p>MATERIALS: Oregon Pine, Brass            DIMENSIONS: Diameter 38,5 cm, height 27 cm            COLL: 4            ITEM NO.: 840431</p>		 5 702370 000233

## IKEBANA LARGE JAIME HAYON

DESCRIPTION		EXCL. VAT	INCL. VAT
Large vase		180	219
	<p>MATERIALS: Handblown clear glass, brass plated stainless steel            DIMENSIONS: Diameter 24 cm, height 15,5 cm            COLL: 2            ITEM NO.: 840140</p>		 5 704890 401408

## IKEBANA LARGE JAIME HAYON

DESCRIPTION	EXCL. VAT	INCL. VAT
Large vase	180	219



MATERIALS: Handblown clear glass, stainless steel  
 DIMENSIONS: Diameter 24 cm, height 15,5 cm  
 COLLI: 2  
 ITEM NO.: 840147



## IKEBANA SMALL JAIME HAYON

DESCRIPTION	EXCL. VAT	INCL. VAT
Small vase	98	119



MATERIALS: Handblown clear glass, stainless steel  
 DIMENSIONS: Diameter 12 cm, height 13 cm  
 COLLI: 4  
 ITEM NO.: 840146



## IKEBANA SMALL JAIME HAYON

DESCRIPTION	EXCL. VAT	INCL. VAT
Small vase	98	119



MATERIALS: Handblown clear glass, brass plated stainless steel  
 DIMENSIONS: Diameter 12 cm, height 13 cm  
 COLLI: 4  
 ITEM NO.: 840141



## IKEBANA LONG JAIME HAYON

DESCRIPTION	EXCL. VAT	INCL. VAT
Long vase	180	219



MATERIALS: Handblown clear glass, brass plated stainless steel  
 DIMENSIONS: Width 9,5 cm, length 33,5 cm, height 13 cm  
 COLLI: 2  
 ITEM NO.: 840142



## IKEBANA LONG JAIME HAYON

DESCRIPTION	EXCL. VAT	INCL. VAT
Long vase	180	219



MATERIALS: Handblown clear glass, stainless steel  
 DIMENSIONS: Width 9,5 cm, length 33,5 cm, height 13 cm  
 COLLI: 2  
 ITEM NO.: 840148



## IKERU HIGH VASE Jaime Hayon

DESCRIPTION	EXCL. VAT	INCL. VAT
High vase	98	119



MATERIALS: Handblown glass, anodised aluminium  
 COLOUR: Forest green  
 DIMENSIONS: Diameter 16 cm, height: 23,9 cm  
 COLLI: 4  
 ITEM NO.: 840143



## IKERU HIGH VASE JAIME HAYON

DESCRIPTION	EXCL. VAT	INCL. VAT
High vase	98	119



MATERIALS: Handblown glass, anodised aluminium  
 COLOUR: Dusk blue  
 DIMENSIONS: Diameter 16 cm, height: 23,9 cm  
 COLLI: 4  
 ITEM NO.: 840151



## IKERU LOW VASE Jaime Hayon



DESCRIPTION	EXCL. VAT	INCL. VAT
Low vase	114	139





MATERIALS: Handblown glass, anodised aluminium  
 COLOUR: Forest green  
 DIMENSIONS: Diameter 19 cm, height 13,1 cm  
 COLLI: 4  
 ITEM NO.: 840144





## IKERU LOW VASE JAIME HAYON

DESCRIPTION	EXCL. VAT	INCL. VAT
Low Vase	114	139
 <p>MATERIALS: Handblown glass, anodised aluminium            COLOUR: Dusk blue            DIMENSIONS: Diameter 1.9 cm, height 13,1 cm            COLLI: 4            ITEM NO.: 840152</p>	 5 702370 002152	



## MOON EYE VASE GRETHE MEYER

DESCRIPTION	EXCL. VAT	INCL. VAT
Vase set	147	179
 <p>MATERIALS: Moon: Clear glass   Eye: Smoked and clear glass            DIMENSIONS: Moon: Width 1.6 cm, depth 8 cm, height 23 cm   Eye: Width 1.3,5 cm, depth 8 cm, height 1.6 cm            COLLI: 2            ITEM NO.: 840270</p>	 5 704890 402702	

## MINIATURE EGG™ ARNE JACOBSEN

DESCRIPTION	EXCL. VAT	INCL. VAT
Miniature lounge chair	180	219
 <p>MATERIALS: Textile, chromed base            COLOUR: Black            DIMENSIONS: Width 13,5 cm, height 16,5 cm            COLLI: 2            ITEM NO.: 840050</p>	 5 704890 400500	

## MINIATURE EGG™ ARNE JACOBSEN

DESCRIPTION	EXCL. VAT	INCL. VAT
Miniature lounge chair	180	219
 <p>MATERIALS: Textile, chromed base            COLOUR: Red            DIMENSIONS: Width 13,5 cm, height 16,5 cm            COLLI: 2            ITEM NO.: 840051</p>	 5 704890 400517	

## MINIATURE SWAN™ ARNE JACOBSEN

DESCRIPTION	EXCL. VAT	INCL. VAT
Miniature lounge chair	139	169



MATERIALS: Textile, chromed base  
 COLOUR: Black  
 DIMENSIONS: Width 13,5 cm, height 9 cm  
 COLLI: 2  
 ITEM NO.: 840060



## MINIATURE SWAN™ ARNE JACOBSEN

DESCRIPTION	EXCL. VAT	INCL. VAT
Miniature lounge chair	139	169



MATERIALS: Textile, chromed base  
 COLOUR: Red  
 DIMENSIONS: Width 13,5 cm, height 9 cm  
 COLLI: 2  
 ITEM NO.: 840061



## MINIATURE SERIES 7™ ARNE JACOBSEN

DESCRIPTION	EXCL. VAT	INCL. VAT
Miniature chair	65	79



MATERIALS: Lacquered veneer, chromed base  
 COLOUR: Black  
 DIMENSIONS: Width 8,5 cm, height 13 cm  
 COLLI: 4  
 ITEM NO.: 840180



## MINIATURE SERIES 7™ ARNE JACOBSEN

DESCRIPTION	EXCL. VAT	INCL. VAT
Miniature chair	65	79



MATERIALS: Lacquered veneer, chromed base  
 COLOUR: Opium red  
 DIMENSIONS: Width 8,5 cm, height 13 cm  
 COLLI: 4  
 ITEM NO.: 840181



MINIATURE SERIES 7™ ARNE JACOBSEN

DESCRIPTION	EXCL. VAT	INCL. VAT
Miniature chair	65	79



MATERIALS: Lacquered veneer, chromed base  
 COLOUR: Walnut  
 DIMENSIONS: Width 8,5 cm, height 13 cm  
 COLLI: 4  
 ITEM NO.: 840182



ROCKING HORSE FRITZ HANSEN

DESCRIPTION	EXCL. VAT	INCL. VAT
Rocking Horse	693	839



MATERIALS: Lacquered ash, harness leather, halyard  
 COLOUR: Clear lacquered  
 DIMENSIONS: Width 58,5 cm, depth 21 cm, height 60,5 cm  
 COLLI: 1  
 ITEM NO.: 840432



ROCKING HORSE FRITZ HANSEN

DESCRIPTION	EXCL. VAT	INCL. VAT
Rocking Horse	693	839



MATERIALS: Coloured ash, harness leather, halyard  
 COLOUR: Black  
 DIMENSIONS: Width 58,5 cm, depth 21 cm, height 60,5 cm  
 COLLI: 1  
 ITEM NO.: 840433





# SKAGERAK COLLECTION



## COLLAR HANGER TAF

DESCRIPTION	EXCL. VAT	INCL. VAT
	36	44
 <p> <b>MATERIALS:</b> Oak, Stainless Steel  <b>DIMENSIONS:</b> Lenght 43 cm, width 1,5 cm, height 22,5 cm  <b>COLLI:</b> 1  <b>ITEM NO.:</b> 1431018                 </p>	 5 706420 096108	

## COLLAR HANGER TAF

DESCRIPTION	EXCL. VAT	INCL. VAT
	36	44
 <p> <b>MATERIALS:</b> Oak, Aluminum  <b>COLOUR:</b> Black  <b>DIMENSIONS:</b> Lenght 43 cm, width 1,5 cm, height 22,5 cm  <b>COLLI:</b> 1  <b>ITEM NO.:</b> 1431019                 </p>	 5 706420 096122	

## COLLAR HANGER TAF



DESCRIPTION	EXCL. VAT	INCL. VAT
	36	44
 <p> <b>MATERIALS:</b> Teak, Stainless Steel  <b>DIMENSIONS:</b> Lenght 43 cm, width 1,5 cm, height 22,5 cm  <b>COLLI:</b> 1  <b>ITEM NO.:</b> 1431022                 </p>	 5 706420 101154	

## PILOT COAT HANGER NINA TOLSTRUP



DESCRIPTION	EXCL. VAT	INCL. VAT
	57	69
 <p> <b>MATERIALS:</b> Oak, Stainless Steel  <b>DIMENSIONS:</b> Lenght 43 cm, width 4 cm, height 21 cm  <b>COLLI:</b> 3  <b>ITEM NO.:</b> S1600627                 </p>	 5 706420 064695	





## PILOT COAT HANGER NINA TOLSTRUP

DESCRIPTION	EXCL. VAT	INCL. VAT
	57	69
 <p> <b>MATERIALS:</b> Oak, Stainless Steel  <b>COLOUR:</b> Black  <b>DIMENSIONS:</b> Length 43 cm, width 4 cm, height 21 cm  <b>COLL:</b> 3  <b>ITEM NO.:</b> S1600628                 </p>		 5 706420 064701



## FIONIA TRAY SKAGERAK

DESCRIPTION	EXCL. VAT	INCL. VAT
	131	159
 <p> <b>MATERIALS:</b> Teak  <b>DIMENSIONS:</b> Length 48 cm, width 32 cm, height 6 cm  <b>COLL:</b> 1  <b>ITEM NO.:</b> S1600509                 </p>		 5 706420 028925



## FIONIA TRAY SKAGERAK

DESCRIPTION	EXCL. VAT	INCL. VAT
	131	159
 <p> <b>MATERIALS:</b> Oak  <b>DIMENSIONS:</b> Length 48 cm, width 32 cm, height 6 cm  <b>COLL:</b> 1  <b>ITEM NO.:</b> S1600588                 </p>		 5 706420 034421



## FIONIA TRAY SKAGERAK

DESCRIPTION	EXCL. VAT	INCL. VAT
	139	169
 <p> <b>MATERIALS:</b> Oak  <b>DIMENSIONS:</b> Length 52 cm, width 36 cm, height 6 cm  <b>COLL:</b> 1  <b>ITEM NO.:</b> 1600506                 </p>		 5 706420 101246

## FIONIA TRAY SKAGERAK

DESCRIPTION	EXCL. VAT	INCL. VAT
	139	169
 <p>MATERIALS: Teak            DIMENSIONS: Lenght 52 cm, width 36 cm, height 6 cm            COLLI: 1            ITEM NO.: S1600507</p>		 5 706420 028901



## NORR TRAY SKAGERAK

DESCRIPTION	EXCL. VAT	INCL. VAT
	81	99
 <p>MATERIALS: Oak, Leather            DIMENSIONS: Lenght 46 cm, width 25,5 cm, height 2,5 cm            COLLI: 1            ITEM NO.: S1930233</p>		 5 706420 071051



## NOMAD TABLE TRAY VE2

DESCRIPTION	EXCL. VAT	INCL. VAT
	189	229
 <p>MATERIALS: Oak, Steel            COLOUR: Silk Grey            DIMENSIONS: Lenght 60 cm, width 35 cm, height 22 cm            COLLI: 1            ITEM NO.: 1930251</p>		 5 706420 081647



## NOMAD TRAY VE2

DESCRIPTION	EXCL. VAT	INCL. VAT
	65	79
 <p>MATERIALS: Oak            DIMENSIONS: Lenght 42 cm, width 14 cm, height 3 cm            COLLI: 1            ITEM NO.: S1930230</p>		 5 706420 070924



## NOMAD TRAY VE2

DESCRIPTION	EXCL. VAT	INCL. VAT
	48	59
 <p> <b>MATERIALS:</b> Oak  <b>DIMENSIONS:</b> Length 23,5 cm, width 14 cm, height 2,5 cm  <b>COLL:</b> 1  <b>ITEM NO.:</b> S1930241                 </p>		 5 706420 074069

## DANIA CUTTING BOARD SKAGERAK

DESCRIPTION	EXCL. VAT	INCL. VAT
	98	119
 <p> <b>MATERIALS:</b> Teak End Grain  <b>DIMENSIONS:</b> Length 35 cm, width 24 cm, height 4 cm  <b>COLL:</b> 4  <b>ITEM NO.:</b> S1990845                 </p>		 5 706420 030201



## DANIA CUTTING BOARD SKAGERAK

DESCRIPTION	EXCL. VAT	INCL. VAT
	98	119
 <p> <b>MATERIALS:</b> Teak End Grain  <b>DIMENSIONS:</b> Length 40 cm, width 24 cm, height 2,5 cm  <b>COLL:</b> 4  <b>ITEM NO.:</b> S1990844                 </p>		 5 706420 070160

## DANIA CUTTING BOARD SKAGERAK

DESCRIPTION	EXCL. VAT	INCL. VAT
	114	139
 <p> <b>MATERIALS:</b> Teak End Grain  <b>DIMENSIONS:</b> Length 50 cm, width 27 cm, height 3 cm  <b>COLL:</b> 4  <b>ITEM NO.:</b> S1990847                 </p>		 5 706420 030218

## DANIA CUTTING BOARD SKAGERAK

DESCRIPTION	EXCL. VAT	INCL. VAT
	214	259
 <p> <b>MATERIALS:</b> Teak End Grain  <b>DIMENSIONS:</b> Length 56 cm, width 35 cm, height 4 cm  <b>COLL:</b> 1  <b>ITEM NO.:</b> S1990890                 </p>		 5 706420 047131



## NORDIC SERVING TRAY VE2

DESCRIPTION	EXCL. VAT	INCL. VAT
	131	159
 <p> <b>MATERIALS:</b> Oak  <b>DIMENSIONS:</b> Diameter 30 cm, height 3,5 cm  <b>COLL:</b> 1  <b>ITEM NO.:</b> 1600315                 </p>		 5 706420 080961

## NORDIC SERVING TRAY VE2

DESCRIPTION	EXCL. VAT	INCL. VAT
	205	249
 <p> <b>MATERIALS:</b> Oak  <b>DIMENSIONS:</b> Diameter 45 cm, height 3,5 cm  <b>COLL:</b> 1  <b>ITEM NO.:</b> 1600316                 </p>		 5 706420 080947

## NO. 10 TRAY LARGE TERUHIRO YANAGIHARA

DESCRIPTION	EXCL. VAT	INCL. VAT
	106	129
 <p> <b>MATERIALS:</b> Oak  <b>DIMENSIONS:</b> Length 53,5 cm, width 34 cm, height 3,5 cm  <b>COLL:</b> 1  <b>ITEM NO.:</b> 1600496                 </p>		 5 706420 104315

NO. 10 TRAY MEDIUM TERUHIRO YANAGIHARA

DESCRIPTION	EXCL. VAT	INCL. VAT
	98	119



MATERIALS: Oak  
 DIMENSIONS: Length 45 cm, width 32 cm, height 3,5 cm  
 COLLI: 1  
 ITEM NO.: 1600495



NO. 10 TRAY SMALL TERUHIRO YANAGIHARA

DESCRIPTION	EXCL. VAT	INCL. VAT
	77	94



MATERIALS: Oak  
 DIMENSIONS: Length 36,5 cm, width 30 cm, height 3,5 cm  
 COLLI: 1  
 ITEM NO.: 1600494



SILD TRAY SØREN REFSGAARD

DESCRIPTION	EXCL. VAT	INCL. VAT
	131	159



MATERIALS: Teak  
 DIMENSIONS: Length 55 cm, width 16 cm, height 1,5 cm  
 COLLI: 1  
 ITEM NO.: 1600973



SILD TRAY SØREN REFSGAARD

DESCRIPTION	EXCL. VAT	INCL. VAT
	156	189





MATERIALS: Teak  
 DIMENSIONS: Length 49 cm, width 24,5 cm, height 1,5 cm  
 COLLI: 1  
 ITEM NO.: 1600971



## NORR CARRIER DITTE BUUS NIELSEN

DESCRIPTION	EXCL. VAT	INCL. VAT
	114	139
 <p> <b>MATERIALS:</b> Oak, Brass Plated Steel  <b>DIMENSIONS:</b> Length 22 cm, width 15,5 cm, height 20,5 cm  <b>COLLI:</b> 1  <b>ITEM NO.:</b> 1930237                 </p>		 5 706420 087007

## NORR PAPER TOWEL HOLDER DITTE BUUS NIELSEN

DESCRIPTION	EXCL. VAT	INCL. VAT
	69	84
 <p> <b>MATERIALS:</b> Oak, Leather  <b>COLOUR:</b> Black  <b>DIMENSIONS:</b> Diameter 1.4 cm, height 30,5 cm  <b>COLLI:</b> 2  <b>ITEM NO.:</b> 1930261                 </p>		 5 706420 089803

## NORR PAPER TOWEL HOLDER DITTE BUUS NIELSEN

DESCRIPTION	EXCL. VAT	INCL. VAT
	65	79
 <p> <b>MATERIALS:</b> Oak, Leather  <b>DIMENSIONS:</b> Diameter 1.4 cm, height 30,5 cm  <b>COLLI:</b> 2  <b>ITEM NO.:</b> S1930239                 </p>		 5 706420 073819



## HAMMER GRINDER CHRISTOFFER HARLANG

DESCRIPTION	EXCL. VAT	INCL. VAT
	65	79
 <p> <b>MATERIALS:</b> Oak  <b>DIMENSIONS:</b> Diameter 6,5 cm, height 12 cm  <b>COLLI:</b> 2  <b>ITEM NO.:</b> 1836571                 </p>		 5 706420 103097



## HAMMER GRINDER CHRISTOFFER HARLANG

DESCRIPTION	EXCL. VAT	INCL. VAT
	65	79
 <p>MATERIALS: Teak COLOUR: Oiled DIMENSIONS: Diameter 6,5 cm, height 12 cm COLL: 2 ITEM NO.: 1836572</p>		 5 706420 103080



## AINO MIRROR SMALL WESLEY WALTERS & SALLA LUHTASELA

DESCRIPTION	EXCL. VAT	INCL. VAT
	131	159
 <p>MATERIALS: Oak, Mirror DIMENSIONS: Width 14 cm, depth 4 cm, height 21 cm COLL: 1 ITEM NO.: 1480003</p>		 5 706420 094227



## AINO MIRROR LARGE WESLEY WALTERS & SALLA LUHTASELA

DESCRIPTION	EXCL. VAT	INCL. VAT
	205	249
 <p>MATERIALS: Oak, Mirror DIMENSIONS: Width 26,5 cm, depth 7 cm, height 32 cm COLL: 1 ITEM NO.: 1480004</p>		 5 706420 094241

## DANIA MAT SKAGERAK

DESCRIPTION	EXCL. VAT	INCL. VAT
	189	229
 <p>MATERIALS: Teak, Stainless Steel DIMENSIONS: Length 58,5 cm, width 41 cm, height 2,5 cm COLL: 1 ITEM NO.: S1600231</p>		 5 706420 028840



## DANIA STOOL DESIGNIT

DESCRIPTION	EXCL. VAT	INCL. VAT
	189	229
 <p> <b>MATERIALS:</b> Teak  <b>DIMENSIONS:</b> Width 38 cm, depth 34,5 cm, height 27,5 cm  <b>COLL:</b> 1  <b>ITEM NO.:</b> S1600630                 </p>	 5 706420 036845	



## DANIA STOOL DESIGNIT

DESCRIPTION	EXCL. VAT	INCL. VAT
	189	229
 <p> <b>MATERIALS:</b> Oak  <b>DIMENSIONS:</b> Width 38 cm, depth 34,5 cm, height 27,5 cm  <b>COLL:</b> 1  <b>ITEM NO.:</b> S1600631                 </p>	 5 706420 054214	

## DANIA BOX 2 SKAGERAK



DESCRIPTION	EXCL. VAT	INCL. VAT
	81	99
 <p> <b>MATERIALS:</b> Teak  <b>DIMENSIONS:</b> Length 31 cm, width 22 cm, height 13 cm  <b>COLL:</b> 1  <b>ITEM NO.:</b> S1600572                 </p>	 5 706420 049388	

## DANIA BOX 3 SKAGERAK



DESCRIPTION	EXCL. VAT	INCL. VAT
	114	139
 <p> <b>MATERIALS:</b> Teak  <b>DIMENSIONS:</b> Length 31 cm, width 22 cm, height 25,5 cm  <b>COLL:</b> 1  <b>ITEM NO.:</b> S1600568                 </p>	 5 706420 034292	





## DANIA BOX 4 SKAGERAK

DESCRIPTION	EXCL. VAT	INCL. VAT
	114	139
 <p>MATERIALS: Teak            DIMENSIONS: Lenght 44,5 cm, width 31 cm, height 13 cm            COLLI: 1            ITEM NO.: S1600571</p>		 5 706420 047117

## DANIA LETTER TRAY SKAGERAK

DESCRIPTION	EXCL. VAT	INCL. VAT
	164	199
 <p>MATERIALS: Oak            DIMENSIONS: Lenght 28 cm, width 40 cm, height 21 cm            COLLI: 1            ITEM NO.: S1902007</p>		 5 706420 070740



## NOMAD PEN HOLDER VE2

DESCRIPTION	EXCL. VAT	INCL. VAT
	36	44
 <p>MATERIALS: Oak            DIMENSIONS: Lenght 7,5 cm, width 7,5 cm, height 13 cm            COLLI: 1            ITEM NO.: S1930242</p>		 5 706420 074083

## NOMAD LETTER TRAY VE2

DESCRIPTION	EXCL. VAT	INCL. VAT
	77	94
 <p>MATERIALS: Oak            DIMENSIONS: Lenght 23,5 cm, width 32 cm, height 4 cm            COLLI: 1            ITEM NO.: S1930240</p>		 5 706420 074045

## NOMAD BOX VE2

DESCRIPTION	EXCL. VAT	INCL. VAT
	65	79
 <p>MATERIALS: Oak DIMENSIONS: Length 14 cm, width 14 cm, height 5,5 cm COLLI: 1 ITEM NO.: S1930231</p>		 5 706420 070931

## EDGE POT STILLEBEN

DESCRIPTION	EXCL. VAT	INCL. VAT
	48	59
 <p>MATERIALS: Terracotta COLOUR: Burned Red DIMENSIONS: Diameter 18 cm, height 18 cm COLLI: 2 ITEM NO.: 1810410</p>		 5 706420 077756

## EDGE POT STILLEBEN

DESCRIPTION	EXCL. VAT	INCL. VAT
	48	59
 <p>MATERIALS: Terracotta COLOUR: Light Grey DIMENSIONS: Diameter 18 cm, height 18 cm COLLI: 2 ITEM NO.: 1810433</p>		 5 706420 108986

## EDGE POT STILLEBEN

DESCRIPTION	EXCL. VAT	INCL. VAT
	81	99
 <p>MATERIALS: Terracotta COLOUR: Burned Red DIMENSIONS: Diameter 25 cm, height 24 cm COLLI: 2 ITEM NO.: 1810430</p>		 5 706420 108955

## EDGE POT STILLEBEN

DESCRIPTION	EXCL. VAT	INCL. VAT
	81	99
 <p> <b>MATERIALS:</b> Terracotta  <b>COLOUR:</b> Light Grey  <b>DIMENSIONS:</b> Diameter 25 cm, height 24 cm  <b>COLLI:</b> 2  <b>ITEM NO.:</b> 1810434                 </p>	 5 706420 108993	



## EDGE POT STILLEBEN

DESCRIPTION	EXCL. VAT	INCL. VAT
	139	169
 <p> <b>MATERIALS:</b> Terracotta  <b>COLOUR:</b> Burned Red  <b>DIMENSIONS:</b> Diameter 35 cm, height 34 cm  <b>COLLI:</b> 2  <b>ITEM NO.:</b> 1810431                 </p>	 5 706420 108962	

## EDGE POT STILLEBEN

DESCRIPTION	EXCL. VAT	INCL. VAT
	139	169
 <p> <b>MATERIALS:</b> Terracotta  <b>COLOUR:</b> Light Grey  <b>DIMENSIONS:</b> Diameter 35 cm, height 34 cm  <b>COLLI:</b> 2  <b>ITEM NO.:</b> 1810435                 </p>	 5 706420 109006	



## STELLA CHRISTMAS TREE BASE SKAGERAK

DESCRIPTION	EXCL. VAT	INCL. VAT
	321	389
 <p> <b>MATERIALS:</b> Oak, Brass Plated Steel  <b>DIMENSIONS:</b> Diameter 50,5 cm, height 15,5 cm  <b>COLLI:</b> 1  <b>ITEM NO.:</b> 1986045  <b>NOTE:</b> Cup max diameter 9,5 cm                 </p>	 5 706420 101222	

## BEACH TENNIS (SKAGERAK GAMES) AURÉLIEN BARBRY

DESCRIPTION	EXCL. VAT	INCL. VAT
	139	169
 <p> <b>MATERIALS:</b> Teak, Canvas  <b>COLOUR:</b> Dark Green, Dusty Coral  <b>DIMENSIONS:</b> Length 36 cm, width 24 cm, height 3 cm  <b>COLLI:</b> 1  <b>ITEM NO.:</b> 1994002                 </p>		 5 706420 094043

## BEACH TENNIS BALLS (SKAGERAK GAMES) AURÉLIEN BARBRY

DESCRIPTION	EXCL. VAT	INCL. VAT
	11	14
 <p> <b>MATERIALS:</b> Rubber  <b>COLOUR:</b> Dusty Coral  <b>DIMENSIONS:</b> Diameter 5,5 cm  <b>COLLI:</b> 1  <b>ITEM NO.:</b> 1994002-6                 </p>		 5 706420 098928