

## Lammhults design meubilair

**LAMMHULTS**

# INDEX

<b>SALES TERMS</b>	3	<b>MODULAR SEATING</b>	
<b>PRICE CATEGORIES FABRICS/LEATHERS</b>	4	AREA	43
<b>CONTACTS</b>	5	AREA RADIUS	46
<b>COLOR &amp; MATERIAL OVERVIEW</b>	6	BAU	47
<b>ENVIRONMENTAL DOCUMENTATION</b>	9	GEOFANTI	49
<b>EXPRESS RANGE</b>	13	SUNNY	51
<b>SPARE PARTS</b>	73	TEIUS	52
 		<b>TABLES &amp; TROLLEYS</b>	
<b>CHAIRS &amp; ARMCHAIRS</b>		ADD	53
ADD MOVE	14	ADD CABLE TABLE	54
ARCHAL	15	ARCHAL T	55
ARCHAL XL	16	ARCHAL X	56
ATLAS AIR	17	ATTACH	57
CAMPUS	18	CAMPUS	59
CAMPUS AIR	20	CARGO	61
CAROUSEL	22	CHICAGO	62
GRADE	23	CIAO	63
PENNE	25	FUNK	64
PLANKA	26	PONTO	66
SPIRA	27	QUICKLY	67
TABURETT PLUS	29	TENSION	68
X75-2	30	POWER & COMMUNICATION PORTS	69
 		<b>ACCESSORIES</b>	
<b>STOOLS &amp; BARSTOOLS</b>		ADD	70
A22	31	S70-12	72
ADD	32		
ADD MOVE	33		
CAMPUS AIR	34		
S70-3	35		
TABURETT	36		
 		<b>NOTE!</b>	
<b>EASY CHAIRS &amp; SOFAS</b>		When placing an order, be sure to provide complete information about finish and color choice on e.g. stand, seat and back, table top and fabric name incl. color number.	
APERI	37	When choosing a powder coat color in our Select Color range, a set-up cost of 331 EURO per color and order is added.	
AREA	43	Products with eco-labelled options are marked with the following symbols:	
AREA RADIUS	46		
BAU	47	MÖBELFAKTA	
CAJAL	38		
CINEMA	39		
CORSO	40		
GEOFANTI	49		
PORTUS	41		
S70-4 & S70-5	42		
SUNNY	51		
TEIUS	52		

For more information, see overview on page 9.

# SALES TERMS

## PRICELIST EXPORT FREE

Valid from September 1, 2024

## PRICES

All previous pricelists are no longer valid.  
All prices are quoted in EURO excl. VAT.  
Send all orders to: [order@lammhults.se](mailto:order@lammhults.se)

## TERMS OF PAYMENT

30 days net. We reserve the right to charge 2% interest / month on past-due payments. For larger order amounts, bank guarantees or other financial securities may be required with the order.

## PAYMENT

Bank: Danske Bank  
Sweden Branch, Stockholm  
IBAN: SE951200000012133600213  
BIC/SWIFT: DABASESX  
Payment by cheque is not accepted.

## RESERVATION REGARDING OWNERSHIP

Deliveries will only be effected at our terms of payment and delivery. The goods remain the property of Lammhults until full payment has been settled.

## WEIGHT AND VOLUME

Stated weights are net (kg) per product. Stated volumes are approx. freight volume incl. packaging.

Note! The freight volume for a product can vary depending on the quantity ordered, as stackable products are packed together as much as possible. As we constantly work to optimize our shipping in accordance with our quality and environmental work, changes to the specified packaging size may occur depending on the total content of the order.

## TERMS OF DELIVERY

DAP (Incoterms 2020)

Free delivery to warehouse of orders with a value over 1.300 EUR net.

A freight and administration fee of 120 EUR net will apply on orders below this value. A customs clearance fee of 50 EUR net applies for Switzerland.

Special requests such as on-time demand delivery or on-site demand delivery, warehousing, reloading, delivery to private person addresses or special truck types and equipments will be offered and charged separately. For deliveries directly to the end customer it is the dealer's/distributors responsibility to ensure accessibility for truck and trailer. If, according to carrier's judgement, not possible a freight surcharge will be added at prime cost.

Goods-marking other than the Lammhults standard is possible according to agreement but may result in an extra cost.  
Change of delivery address after the item has been despatched from Lammhults always entails an extra cost!

## CANCELLATION & CHANGE REQUESTS OF ORDER

The confirmation of received order forms the basis of the order and is expected to be reviewed by the purchaser within 48 hours. After 48 hours the order is considered approved by the purchaser unless otherwise notified. In case of changes in the order after an approved order, a fee of 120 EURO net will be charged, in addition to any spent costs for material and labor. Note that some material may be ordered immediately after an approved order confirmation.

In case of cancellation of order approved by the purchaser, the following terms apply:

- Earlier than 16 days before delivery, spent material and labor costs will be charged.
- 6-15 days before delivery, 50% of net price will be charged.
- 0-5 days before delivery, 75% of net price will be charged.

We reserve the right to make changes in construction without notice.

## PRODUCT WARRANTIES

Lammhults warrants to the original purchaser that standard products will be free of defects in workmanship and materials for a period of 5 years from the date of original invoice. For fabrics and leathers the offered warranty period is 1 year.

On Campus chair and armchair we offer 10 years warranty. On Campus barstool and Campus Air chair, armchair and barstool the warranty period is 5 years. All accessories have a warranty period of 5 years.

We offer 10 year warranty on all stackable Spira models (excl. seat & back in polyurethane).

For products certified according to the Nordic Swan Ecolabel, we offer spare parts for 10 years from the manufacturing date.

For special product variations the warranty period is 1 year.

Lammhults warranties do not apply to normal wear and tear, customer's fabric, customer's own or other third-party materials, effects of extreme temperature, unusual environmental conditions or outdoor use of products not specifically stated suitable for outdoor.

**IMPORTANT:** For additional purchases of chairs and tables in veneer or stain, color variations may occur due to the fact that veneer and stain matures with time.

**CLAIMS AND TRANSPORT DAMAGES** In case of claim or transport damage contact us on [claims@lammhults.se](mailto:claims@lammhults.se) with information regarding the claim incl. order number and images. The claim will not be processed until Lammhults has received all necessary information, images included. Lammhults may want the product(s) returned to the factory in order to process the claim. Lammhults shall after approved claim either repair or replace faulty products or parts.

For damages which have occurred during transport, the following conditions apply:

A. Evident damages on goods and / or packaging must be documented with a written note on the freight bill, with the signature of the driver. Product damages must immediately be reported to Lammhults in writing. Transport damages must be reported according to this routine in order for a claim to be accepted.

B. Concealed damages which cannot be assumed to have been evident at goods reception, or damages not evident due to large goods volumes received, shall be reported to Lammhults in writing immediately after discovery, but not later than 6 days after receipt of the goods. If examination of a complete shipment is not possible, the packing bill shall be signed "Goods unchecked" with the signature of driver.

All damages according to A and B should be documented with photos in order to facilitate the handling of the claim.

**DAMAGES AND DISPUTES** Lammhults is liable only for direct loss, and any compensation payable under the parties' agreement may never exceed 2.000 EURO. The parties' agreement shall be governed by the substantive laws of Sweden, explicitly excluding the United Nations Convention on the International Sales of Goods (CISG). Any claim, dispute or controversy between the parties shall be finally settled by Swedish courts. Växjö district shall always be the court of first instance.

**ENVIRONMENTAL CERTIFICATION** Lammhults is certified according to SS-EN ISO 14001& SS-EN ISO 9001 For more environmentally related information,



# PRICE CATEGORIES FABRICS/LEATHERS

## A

Excl. fabric

## B

<b>Acton</b>	VE
<b>Ally</b>	SV
Atlantis*	RO
<b>Avon</b>	VE
<b>Blazer</b>	CA
<b>Capture</b>	GA
<b>Crisp</b>	GA
<b>Cura*</b>	GA
<b>Cyber</b>	GA
<b>Easy</b>	SV
<b>Fame</b>	GA
<b>Focus</b>	GA
<b>Focus Melange</b>	GA
<b>Grain</b>	GA
<b>Harper*</b>	SV
<b>Heidal*</b>	GU
<b>Hero</b>	KV
<b>Hero Heather</b>	KV
<b>Jazz</b>	NE
<b>Lido*</b>	NE
<b>Lido Trend*</b>	NE
Linara	RO
<b>Macro*</b>	SV
<b>Mainline Flax</b>	CA
<b>Medley*</b>	GA
<b>Norfolk</b>	VE
<b>Harding*</b>	VE
<b>Remix 3</b>	KV
<b>Select</b>	GA
<b>Semi</b>	SV
Silvertext*	BJ
<b>Stella*</b>	NE
<b>Step*</b>	GA
<b>Step Melange*</b>	GA
<b>Swing</b>	GA
<b>Synergy</b>	CA

## C

<b>Amdal</b>	GU
<b>Auckland*</b>	VE
<b>Balance</b>	SV
<b>Bardal</b>	GU
<b>Blues</b>	NE
<b>Bowen</b>	VE
<b>Breeze Fusion</b>	GA
<b>Canvas 2</b>	KV
<b>Dikson</b>	VE
<b>Divina 3</b>	KV
<b>Focus Royal</b>	GA
<b>Foster</b>	VE
<b>Fuga</b>	VE

<b>Gamut</b>	VE
<b>Illusion*</b>	NE
<b>Melange Nap</b>	KV
<b>Mood</b>	GA
<b>Morph*</b>	GA
Parotega	BJ
<b>Passion</b>	GA
<b>Puxx 1*</b>	BJ
<b>Puxx 2*</b>	BJ
<b>Rami</b>	SV
<b>Rami Plus</b>	SV
<b>Re-wool</b>	KV
<b>Sport</b>	KV
<b>Steelcut 3</b>	KV
<b>Steelcut Trio 3</b>	KV
<b>Tonus</b>	KV

## D

<b>Divina Melange</b>	KV
<b>Divina MD</b>	KV
Fleck	RO
Ruskin	RO

## E

<b>Barnum</b>	NE
<b>Debut</b>	SV
<b>Fiord 2</b>	KV
<b>Hallingdal 65</b>	KV
<b>Nobel</b>	GA
<b>Steelcut Quartet</b>	KV
<b>Vidar</b>	KV
<b>Zero</b>	KV

## F

Leather Elmo Nordic	EL
00385, 02071, 11039,	
99008, 43404, 53374,	
93009	

**X** Ask for a quote

<b>Arda</b>	KV
<b>Elle</b>	KV
<b>Gentle</b>	KV
<b>Moss</b>	KV

**\*The fabric is not suitable on all our models. For more information contact Customer**

## FABRIC MANUFACTURERS

CA	Camira
BJ	Bröderna Jörgensen
EL	Elmo
GA	Gabriel
GU	Gudbrandsdalens
KV	Kvadrat
NE	Nevotex
RO	Romo
SV	Svensson
VE	Vescom

## REQUIRED METERAGE

Meterage in the pricelist is based on plain colors.

Fabrics in **bold** fulfil demands according to the E.U. ECO-Label, Greenguard Gold or ÖKO-TEX.

Most fabrics fulfil fire regulation demands according to standard SS-EN 1021-1,2.

Other fabrics/leathers offered on request.

## CUSTOMERS' FABRIC

On orders excl. fabric an extra fee of 120 EURO net per fabric and/or color will be charged. Please advise width and repeat so meterage can be checked and supply a sample for approval. Customers' leather; A + 10%.

# CONTACTS

## HEADQUARTERS

### SHOWROOM STOCKHOLM

Adolf Fredriks Kyrkogata 15  
SE-11137 STOCKHOLM  
Sweden  
Phone +46 472 26 95 00

### SHOWROOM COPENHAGEN

Danneskiold-Samsøes Allé 15  
DK-1434 COPENHAGEN  
Denmark  
Phone +45 24 59 89 59

### SHOWROOM GOTHENBURG

Studio L6  
Lasarettsgatan 6  
SE-411 19 GÖTEBORG  
Sweden  
Phone +46 31 13 83 90

### SHOWROOM OSLO

Pilestredet 75c, inngang 38  
NO-0354 OSLO  
Norway  
Phone +47 48 24 41 98

### SHOWROOM MALMÖ

Skeppsbron 3  
SE-211 20 MALMÖ  
Sweden  
Mobile +46 70 928 11 15

### SHOWROOM WOERDEN

Polanerzandweg 1  
NL-3446 CC WOERDEN  
The Netherlands  
Phone +31 348 44 33 23

### SHOWROOM PARIS

5 bis rue Gabriel Laumain  
FR-75010 PARIS  
France  
Mobile +33 609 782 730

# COLOR & MATERIAL OVERVIEW

## POWDER COATS

Powder coated frames are offered in standard colors white, aluminium, graphite and black in smooth or textured finish. Note: Some models are available only in textured finish. In addition to this, we offer a number of colors via our **Select Color** range for an additional set-up cost of **353 EURO** per color and order. State the 4-digit color code when placing an order.

For colors in addition to these, contact [order@lammhults.se](mailto:order@lammhults.se) for a quote.

### STANDARD - SMOOTH & TEXTURE

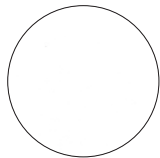

White  
Smooth 8900  
Texture 8901

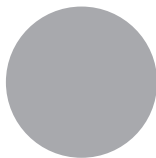

Aluminium  
Smooth 8800  
Texture 8801

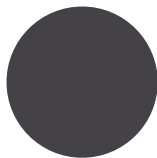

Graphite  
Smooth 8760  
Texture 8761



Black  
Smooth 8000  
Texture 8001

### SELECT COLOR - SMOOTH & TEXTURE



Light beige  
Smooth 8430  
Texture 8431



Beige  
Smooth 8400  
Texture 8401

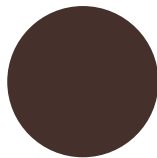

Brown  
Smooth 8440  
Texture 8441

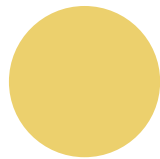

Yellow  
Smooth 8130  
Texture 8131



Signal yellow  
Smooth 8100  
Texture 8101

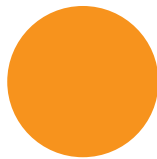

Yellow orange  
Smooth 8110  
Texture 8111

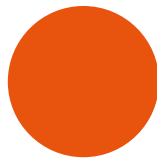

Orange  
Smooth 8140  
Texture 8141

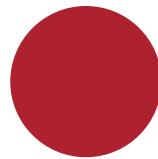

Red  
Smooth 8330  
Texture 8331



Light blue  
Smooth 8540  
Texture 8541

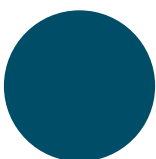

Blue  
Smooth 8550  
Texture 8551

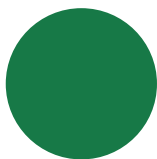

Green  
Smooth 8600  
Texture 8601



Grey green  
Smooth 8650  
Texture 8651

### PLASTIC (CAMPUS AIR / GRADE / PENNE / TABURETT / TABURETT PLUS)

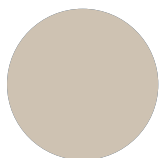

Light beige

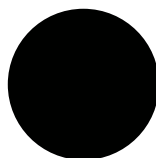

Black

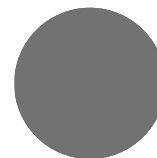

Grey

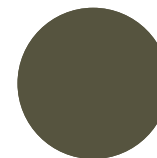

Grey green

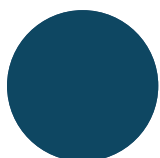

Blue

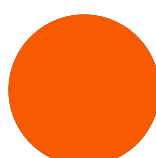

Orange

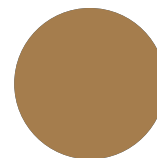

Yellow brown

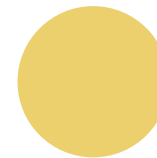

Yellow

Color samples may be subject to slight variation from the finished product.

LAMMHULTS Pricelist Export Free 2024 all prices in EURO excl. VAT

**VENEER**



Oak

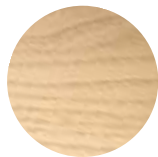

Ash

**STAIN COLORS**



431  
White

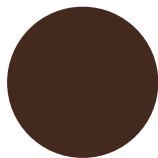

744  
Brown



20  
Black

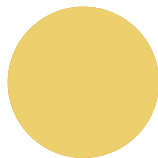

713  
Yellow

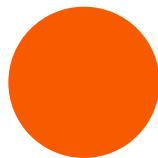

714  
Orange

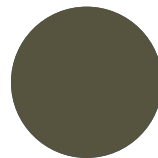

765  
Grey green

**MELAMINE**

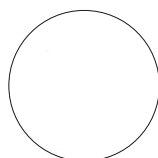

White



White grey\*

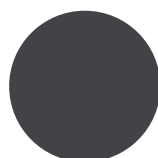

Graphite\*

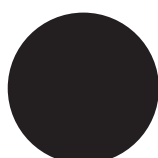

Black  
PerfectSense  
Matte

**HIGH PRESSURE LAMINATE**

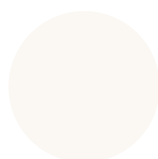

White



White grey\*



Light beige



Light blue



Yellow

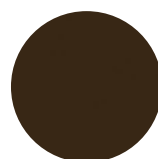

Brown



Black

**COMPACT LAMINATE**

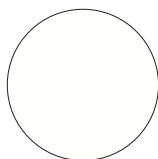

White, black edges



Black, black edges

**LINOLEUM**



4176  
Mushroom



4179  
Smokey Blue



4186  
Orange Blast



4178  
Iron



4166\*  
Charcoal

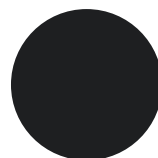

4023  
Nero

\*Discontinued in 2025

**ELMO NORDIC LEATHER**



00385  
Eggshell

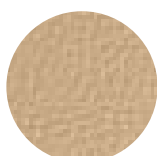

02071  
Natural

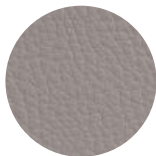

11039  
Warm grey



99008  
Black



43404  
Light brown



55374  
Brown



93009  
Dark brown

**ATLAS AIR**



Black



Rust brown

**CORSO / SUNNY / X75-2**



Black



















































































Natural































Color samples may be subject to slight variation from the finished product.

LAMMHULTS Pricelist Export Free 2024 all prices in EURO excl. VAT











































































































# ENVIRONMENTAL DOCUMENTATION

		CONTAINS RECYCLED/RENEWABLE MATERIAL	DISMANTLABLE PRODUCT	ENVIRONMENTAL PRODUCT DECLARATION	LEED DOCUMENT	MÖBELFAKTA**
Add Move chair						Move chair. ** 
Archal chair & armchair						Archal chair and armchair. ** 
Archal XL conference chair & armchair Archal XL lounge						Archal XL chair and armchair. Archal XL Lounge. ** 
Atlas Air chair & armchair						Atlas Air chair and armchair on 5 feet. ** 
Campus chair & armchair on 4 legs						Campus chair & armchair with seat and back in natural ash or oak alt. stained ash. Alt. with upholstered seat or fully upholstered. ** 
Campus chair & armchair on sledbase						Campus chair with seat and back in natural ash or oak or stained ash and with upholstered seat or fully upholstered. ** 
Campus Air chair & armchair on 4 legs and sledbase						Campus Air chair and armchair. (excl. orange) 
Carousel armchair						
Grade chair / armchair						Grade chair and armchair. Armrests on swivelbase need to be powder coated. ** 
Penne chair / armchair						Penne chair and armchair. 
Planka chair						
Spira chair / armchair						Spira chair & armchair fully upholstered. ** 
Taburett Plus chair						Taburett Plus chair. ** 
X75-2 armchair						

		CONTAINS RECYCLED/ RENEWABLE MATERIAL	DISMANTLABLE PRODUCT	ENVIRONMENTAL PRODUCT DECLARATION	LEED DOCUMENT	MÖBELFAKTA**
A22 stool & barstool						A22 stool & barstool.** 
Add stool & barstool Add Move stool & barstool						Add & Add Move stool & barstool.** 
Campus Air barstool						Campus Air barstool (excl. orange) 
S70-3 barstool						S70-3 barstool.** 
Taburett stool & barstool						Taburett stool SH 46cm.** 

Aperi easy chair & sofa						Aperi easy chair and sofa.** 
Cajal easy chair & sofa						Cajal easy chair and sofa.** 
Cinema easy chair & sofa						Cinema easy chair.** 
Corso easy chair						Corso in canvas or natural linen. 
Portus easy chair & sofa						Portus bench, easy chair and sofa. ** 
S70-4 easy chair & S70-5 sofa						S70-4 easy chair and S70-5 sofa. Powder coated frame. ** 
Sunny easychair & modular seating						Sunny easy chair. ** 
Area modular seating						Area modular seating (excl. 60° footstool & easy chair). ** 
Area Radius modular seating						Area Radius modular seating. ** 
Bau modular seating						Bau modular seating.** 

		CONTAINS RECYCLED/RENEWABLE/MATERIAL	DISMANTLABLE PRODUCT	ENVIRONMENTAL PRODUCT DECLARATION	LEED DOCUMENT	MÖBELFAKTA**
Geofanti modular seating						Geofanti modular seating.** 
Teius modular seating						Teius bench with or without back.**. 
Add table						Add table 
Add Cable table						
Archal T table						Archal T table in birch decor, white/grey or graphite melamine, linoleum or high pressure laminate Formica Collection Colors. TA 
Archal X table						Archal X table in birch decor, white/grey or graphite melamine, linoleum or high pressure laminate Formica Collection Colors. TA 
Attach table						Attach table in white/grey melamine, white high pressure laminate or linoleum. 
Cajal table						Cajal table with table top in linoleum or marble. 
Campus table						Campus table in white/grey melamine. 
Cargo trolley						
Chicago trolley						Chicago III trolley with shelves of black or white compact laminate 
Ciao table						Ciao table 
Funk table						Funk table in white/grey or graphite melamine. 
Ponto table						Ponto table with table top in linoleum or Formica Collection Colors. Legs of solid ash, natural or stained. 
Tension trolley						
Quickly table						Quickly table with table top Flexible in laminate or table top Basic in melamine. 

		CONTAINS RECYCLED/ RENEWABLE MATERIAL	DISMANTLABLE PRODUCT	ENVIRONMENTAL PRODUCT DECLARATION	LEED DOCUMENT	MÖBELFAKTA**
Add accessories						Add Accessories 
S70-12 coat hanger						S70-12 Hatstand 

\*\*Any upholstery needs to be approved according to the EU Ecolable or Oeko-tex standard 100 and fulfil Möbelfakta's requirements according to the following standards: SS-EN ISO 12947-2:2017\*, SS-EN ISO 12945-2:2000, SS-EN ISO 105-B02:2014, SS-EN ISO 13936-2:2004 alt. SS-EN ISO 13936-3:2007, SS-EN ISO 105-X12:2016, SS-EN ISO 105-C06:2010, SS-EN ISO 105-D01:2010, SS-EN ISO 105-E16:2007, SS-EN ISO 105-E04:2013 & EN ISO 5077:2008.

All products marked with Möbelfakta meet the following requirements:

#### SEATING FURNITURE

- Strength, durability and safety: EN 16139:2013
- Surface resistance: EN 12720 :2009+A1:2013, EN 15186 3, EN ISO 105-E04:2013
- Ignitability of upholstered furniture EN 1021-1:2014

#### TABLES

- Strength, durability and safety: EN 15372:2016 Level 2
- Surface resistance: EN 12720 :2009+A1:2013, SS 83 91 22: 2017, EN 15186 3

#### ALL FURNITURE

- Wood or wood-based material is traceable and comes from legal and responsible sources.
- Formaldehyde content max E1 according to EN 13986.
- Plastic parts free from flame retardants, softeners/phtalates, PVC, pigments containing Pb, Cd, Sn, Hg or CrVI.
- Upholstery free from flame retardants, softeners/phtalates.
- Surface treatments free from chromium VI.
- Aromatic hydrocarbons (e.g. toluene, xylene) in surface treatments or finishing products do not exceed 1,0% by weight .
- The applied amounts of VOC-components do not exceed 60 g/m2.
- Surface treatment products are NOT classified with neither of the following hazard classifications: H300, H301, H310, H311, H330, H331, H362, H370, H371, H372, H373, H350, H351, H340, H341 H360, H361, H334, H400, H410, H411, H412, H413, H420.
- Adhesives with VOC <10% and free formaldehyde <0,2%.
- Components and the product as a whole are free from SVHC substances (according to the REACH Candidate List).
- Systematic work with social responsibility according to the principles of UN Global Compact, UN Declaration of human rights and the core principles of the ILO Conventions on human rights in working life.

# EXPRESS RANGE



In our Express range, we can offer following products with a fast delivery time. The Express range leaves our factory within 2-14 working days after a registered order. For orders to be treated as express orders, the subject line must be marked with "Express order" and the order sent to order@lammhults.se. Please also call to inform us that the order has been sent: +46 (0)472-269500.

For more detailed product information, we refer to the product's page here in the price list.

The offer applies to a maximum of 30 chairs/stools and 10 tables per order.

We reserve the right to delivery times specified above in the event of stock shortage.



Remix 163



Avon 7068.05

## ATLAS AIR CHAIR 5-FEET

Art.no.	Description	Price 10
134A52421710E	Seatshell in black mesh, Height adjustable frame in black textured powder coat, Black casters	1039
134A52426010E	Seatshell in black mesh, Height adjustable polished frame, Polished casters	1186

## ATLAS AIR ARMCHAIR 5-FEET

Art.no.	Description	Price 10	Cat. F 26
134B52421710E	Seatshell in black mesh, Height adjustable frame in black textured powder coat, Black casters	1120	
134B52426010E	Seatshell in black mesh, Height adjustable polished frame, Polished casters	1267	
134B54021726E	Seatshell in black mesh with pad in Elmo Nordic leather, Height adjustable frame in black textured powder coat, Black casters	1621	

## CAMPUS AIR CHAIR

Art.no.	Description	Price 10
107A22421710E	Seat and back in black polyamide, frame in black textured powder coat, felt glides	235
107A22424010E	Seat and back in black polyamide, frame in chrome, felt glides	251

## SPIRA CHAIR

Art.no.	Description	Price 22	Cat. B
115A24024022E	Fully upholstered in Kvadrat Remix 163 graphite, frame in chrome, plastic glides, dark cover sleeve	694	
115A24034022E	Fully upholstered in Vescom Avon 7068.05 grey, frame in chrome, plastic glides, dark cover sleeve	694	

## SPIRA ARMCHAIR

Art.no.	Description	Price 22	Cat. B
115B24024022E	Fully upholstered in Kvadrat Remix 163 graphite, frame in chrome, plastic glides, dark armrest and cover sleeve	748	
115B24034022E	Fully upholstered in Vescom Avon 7068.05 grey, frame in chrome, plastic glides, dark armrest cover sleeve	783	

## A22 BAR STOOL H630

Art.no.	Description	Price 10
137C22051710E	Black texture powder coat H630	486

## ADD BAR STOOL H630

Art.no.	Description	Price 22	Cat. B
101C63021722E	Upholstered seat in Kvadrat Remix 163 graphite, frame in black textured powder coat	447	
101C63031722E	Upholstered seat in Vescom Avon 7068.05 grey, frame in black textured powder coat	447	

## TABURETT STOOL H450

Art.no.	Description	Price 10
120D22121710E	Black seat, frame in black textured powder coat H450	191
120D22124010E	Black seat, frame in chrome H450	211

## QUICKLY BASIC TABLE

Art.no.	Description	Price 30	Melamine
143J2B324030E	Table top in white/grey melamine, L1400xW700, chromed legs H720, Grey plastic details	802	

## ADD MOVE

Design Anya Seblon 2016



### Seat and back

Upholstered seat and back of moulded wood with moulded cold foam.

### Frame

Ø22 mm powder coated or chrome-plated steel tubing.

Castors in black or chrome. Seat height 460 mm.

Suspendable with built-in anti-slip protection.



### When ordering, specify:

Fabric and colour

Colour powder coat

Colour casters

\*Additional set-up cost applies for powder coat in our Select Color range, see options.

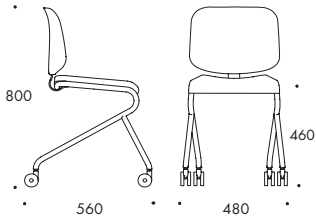

### ADD MOVE CHAIR, FULLY UPHOLSTERED

Weight (kg)

6.0

Freight volume (m<sup>3</sup>) 0.30

Fabric required 600x1300/1400/1500 mm

Art.no.	Description	Cat. A	Cat. B	Cat. C	Cat. D	Cat. E	Cat. F
		21	22	23	24	25	26
102A240120	Fully upholstered, Powder coated* frame H460	855	901	914	925	950	1132
102A240140	Fully upholstered, Chrome frame H460	946	997	1010	1023	1050	1251

### ADDITIONAL OPTIONS ADD MOVE

Art.no.	Description	Price
144M810220	Additional set-up cost Select Color/ color	10
		353



**Seat shell**

Fully upholstered quilted seat shell of moulded wood and moulded cold foam.

**Frame**

4-feet swivel base of cast recycled aluminium incl. comfort tilt, in texture powder coat or polished aluminium. Glides as standard. Castors, auto-return and height adjustable pillar available at additional cost.

5-feet swivel base of cast recycled aluminium incl. comfort tilt and height adjustable pillar, in texture powder coat or polished aluminium. Glides as standard.

**Glides & castors**

Glides available in graphite or white. Castors in black, graphite, white or polished.

**Armrests**

Armrests matching the frame.

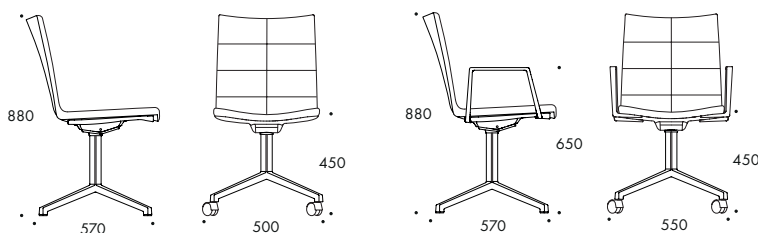

When ordering, specify:

Fabric and colour

Colour powder coat

Colour glides and casters

\* Additional set-up cost applies for powder coat in our Select Color range, see options.

**ARCHAL CHAIR / ARMCHAIR 4-FEET**

Weight (kg) 10.8 / 12.3      Freight volume (m<sup>3</sup>) 0.34      Fabric required 1050x1300/1500 mm

Art.no.	Description	Cat. A	Cat. B	Cat. C	Cat. D	Cat. E	Cat. F
		21	22	23	24	25	26
104A440320	Chair, Fully upholstered with quilting, Powder coated* swivel base	1085	1155	1182	1211	1265	1503
104A440360	Chair, Fully upholstered with quilting, Polished swivel base	1143	1214	1240	1267	1323	1566
104B440320	Armchair, Fully upholstered with quilting, Powder coated* swivel base	1153	1224	1250	1278	1332	1549
104B440360	Armchair, Fully upholstered with quilting, Polished swivel base	1240	1310	1337	1364	1433	1672

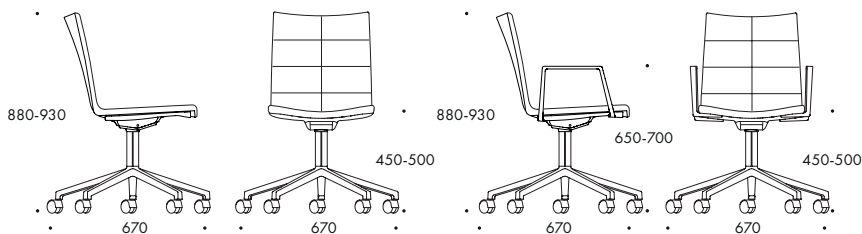

**ARCHAL CHAIR / ARMCHAIR 5-FEET**

Weight (kg) 12.0 / 13.5      Freight volume (m<sup>3</sup>) 0.50      Fabric required 1050x1300/1500 mm

Art.no.	Description	Cat. A	Cat. B	Cat. C	Cat. D	Cat. E	Cat. F
		21	22	23	24	25	26
104A540320	Chair, Fully upholstered with quilting, Powder coated* adjustable swivel base with casters	1257	1327	1356	1383	1437	1692
104A540360	Chair, Fully upholstered with quilting, Polished adjustable swivel base with polished casters	1316	1385	1412	1440	1496	1756
104B540320	Armchair, Fully upholstered with quilting, Powder coated* adjustable swivel base with casters	1324	1395	1423	1450	1506	1737
104B540360	Armchair, Fully upholstered with quilting, Polished adjustable swivel base with polished casters	1411	1481	1510	1538	1605	1863

**ADDITIONAL OPTIONS, ARCHAL**

Art.no.	Description	Price
144M810220	Additional set-up cost Select Color/ color	10
144M210210	Replacement from glides to casters	353
144M211310	Felt glides	60
104M310210	Auto-returning frame. Only in combination with glides	13
104M310310	Height adjustable pillar for 4-feet, Only in combination with glides	129
		129

# ARCHAL XL

Design Johannes Foersom & Peter HiortLorenzen 2018



## Seat shell

Fully upholstered quilted seat shell of moulded wood and moulded cold foam.

## Frame

Conference: 5-feet swivel base of cast recycled aluminium incl. comfort tilt and height adjustable pillar, in texture powder coat or polished aluminium. Castors.

Lounge: 5-feet swivel base of cast recycled aluminium incl. comfort tilt, in texture powder coat or polished aluminium. Glides.

## Glides & castors

Glides available in graphite or white. Castors in black, graphite, white or polished.

## Armrests

Armrests matching the frame. Leather armrest at additional cost.

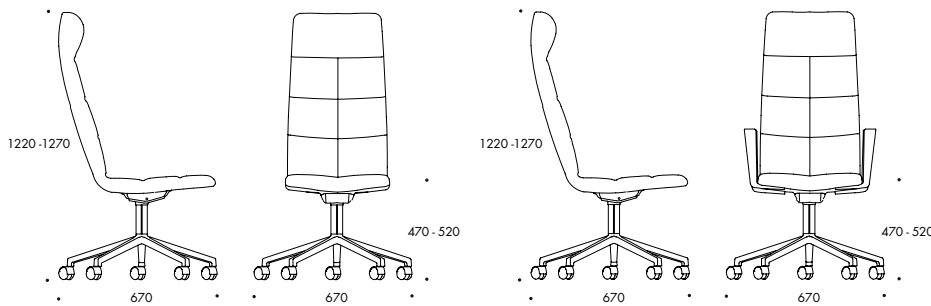

When ordering, specify:

Fabric and colour

Colour powder coat

Colour casters

\*Additional set-up cost applies for powder coat in our Select Color range, see options.

## ARCHAL XL CONFERENCE CHAIR / ARMCHAIR

Weight (kg) 20.0 / 23.0      Freight volume (m<sup>3</sup>) 0.81      Fabric required 1050x1300/1500 mm

Art.no.	Description	Cat. A	Cat. B	Cat. C	Cat. D	Cat. E	Cat. F
		21	22	23	24	25	26
105A540220	Chair, Fully upholstered with quilting, Powder coated* adjustable swivel base with casters	2250	2319	2408	2464	2529	2594
105A540260	Chair, Fully upholstered with quilting, Polished adjustable swivel base with polished casters	2309	2379	2468	2525	2590	2654
105B540220	Armchair, Fully upholstered with quilting, Powder coated* adjustable swivel base with casters	2477	2548	2636	2693	2758	2822
105B540260	Armchair, Fully upholstered with quilting, Polished adjustable swivel base with polished casters	2538	2607	2696	2751	2817	2881

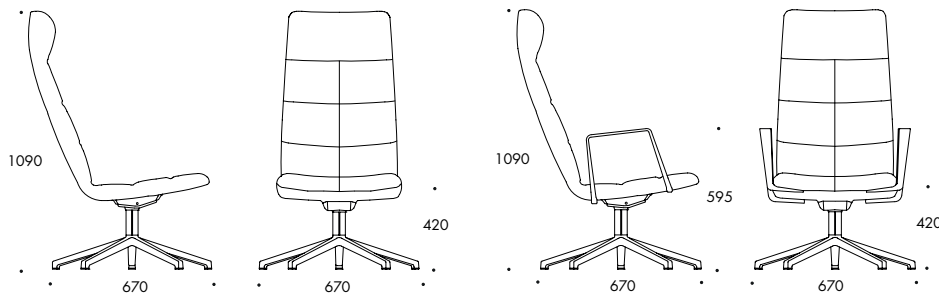

## ARCHAL XL LOUNGE CHAIR / ARMCHAIR

Weight (kg) 20.0 / 23.0      Freight volume (m<sup>3</sup>) 0.81      Fabric required 1050x1300/1500 mm

Art.no.	Description	Cat. A	Cat. B	Cat. C	Cat. D	Cat. E	Cat. F
		21	22	23	24	25	26
105A540320	Chair, Fully upholstered with quilting, Powder coated* swivel base	2156	2227	2316	2372	2437	2501
105A540360	Chair, Fully upholstered with quilting, Polished swivel base	2216	2286	2375	2431	2497	2561
105B540320	Armchair, Fully upholstered with quilting, Powder coated* swivel base	2385	2455	2542	2600	2666	2730
105B540360	Armchair, Fully upholstered with quilting, Polished swivel base	2444	2514	2604	2660	2724	2789

## ADDITIONAL OPTIONS, ARCHAL XL

Art.no.	Description	Price
144M810220	Additional set-up cost Select Color/ color	10
144M211310	Felt glides	353
105M410310	Leather-covered armrests, matching leather when leather upholstered seat shell, otherwise black leather as standard	13
		127



# ATLAS AIR

Design Johannes Foersom & Peter HiortLorenzen 2022



## Seat Shell

Back arch and armrests of powder coated or polished cast recycled aluminum.

Seat shell in black or rust brown mesh with flocked surface.

Replaceable pad attached with push buttons available as an option. Note! The pad can not be retrofitted on version without pad.

## Frame

5-feet swivel base, height adjustable of cast recycled aluminium, powder coated or polished.

Castors is standard. Glides optional.

## Glides & castors

Glides available in powder coat or chrome. Castors in black, graphite, white or polished.

## Armrests

Armrests matching the frame.

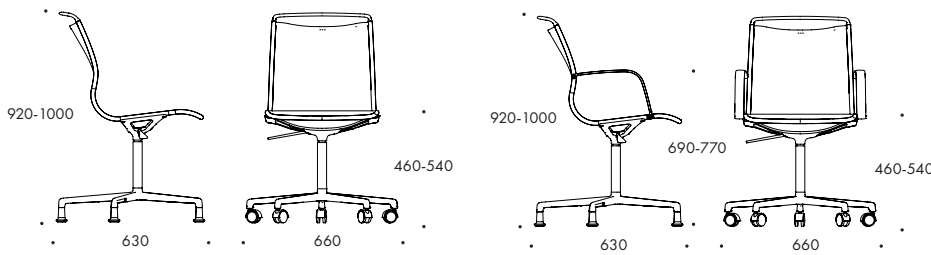

## When ordering, specify:

Colour Mesh

Fabric and colour pad

Colour powder coat

Colour casters

**\*Additional set-up cost applies for powder coat in our Select Color range, see options.**

## ATLAS AIR CHAIR, 5-FEET

Weight (kg) 8.5 / 9.3      Freight volume (m<sup>3</sup>) 0.45

Art.no.	Description	Price
134A524120	Chair, Seatshell in mesh, Powder coated* adjustable swivel base with casters	1039
134A524160	Chair, Seatshell in mesh, Polished adjustable swivel base with polished casters	1186
134B524120	Armchair, Seatshell in mesh, Powder coated* adjustable swivel base with casters	1120
134B524160	Armchair, Seatshell in mesh, Polished adjustable swivel base with polished casters	1267

## ATLAS AIR CHAIR, 5-FEET INCL. PAD

Weight (kg) 9.5 / 10.3      Freight volume (m<sup>3</sup>) 0.45      Fabric required 1100x1300/1500 mm

Art.no.	Description	Cat. A	Cat. B	Cat. C	Cat. D	Cat. E	Cat. F
		21	22	23	24	25	26
134A540120	Chair, Seatshell in mesh incl. pad, Powder coated* adjustable swivel base with casters	1292	1379	1420	1460	1501	1541
134A540160	Chair, Seatshell in mesh incl. pad, Polished adjustable swivel base with polished casters	1438	1526	1566	1606	1647	1689
134B540120	Armchair, Seatshell in mesh incl. pad, Powder coated* adjustable swivel base with casters	1372	1460	1501	1541	1582	1621
134B540160	Armchair, Seatshell in mesh incl. pad, Polished adjustable swivel base with polished casters	1520	1606	1647	1689	1728	1769

## ADDITIONAL OPTION ATLAS AIR

Art.no.	Description	Price
144M810220	Additional set-up cost Select Color/ color	353
134M310110	Atlas Air, Adjustable height for 4-feet	58
134M210110	Atlas Air, Replacement to glides for 5-feet	116



**Seat and back**

Ash or oak veneer, alt. upholstered seat or fully upholstered.

**Frame**

4-leg frame in Ø16 mm powder coated or chrome-plated steel tubing. Plastic glides.  
Sled frame in Ø11 mm powder coated or chrome-plated steel wire. Plastic glides.

**Armrests**

4-leg frame has armrests in wood. Arms in black Polyamide at an additional cost.  
Sled frame has armrests in Polyamide standard colours light beige, grey, black, grey green, blue, orange, yellow brown & yellow.

**Linking and stacking**

4-leg frame: Chair: stackable and linkable c/c 521 mm, Armchair: stackable and linkable c/c 557 mm.

Sled frame: Chair: stackable and linkable c/c 521 mm, Armchair: stackable, linkable and suspendable c/c 557 mm

Note! For long-term stacking of upholstered seats, a stacking pad is recommended.

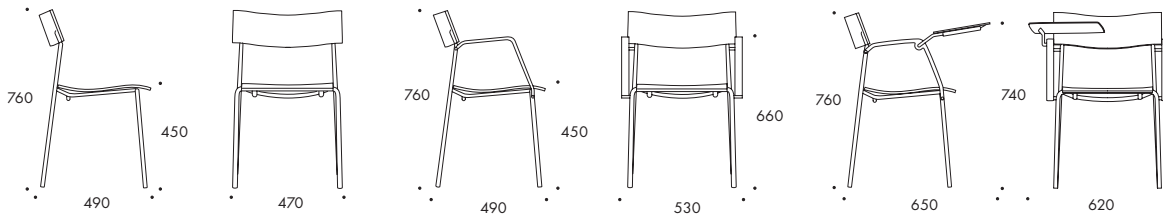

**When ordering, specify:**  
Wood for seat and back  
Colour armrests  
Fabric and colour  
Colour powder coat  
\*Additional set-up cost applies for powder coat in our Select Color range, see options.

**CAMPUS CHAIR / ARMCHAIR**

Weight (kg) 4.8 / 5.2      Freight volume (m<sup>3</sup>) 0.45 / 6

Art.no.	Description	Price
		<b>80</b>
106A225120	Chair, Seat and back in wood, Powder coated* frame	421
106A225140	Chair, Seat and back in wood, Chromed frame	455
106B225120	Armchair, Seat, back and armrests in wood, Powder coated* frame	646
106B225140	Armchair, Seat, back and armrests in wood, Chromed frame	697

**CAMPUS CHAIR, UPHOLSTERED SEAT**

Weight (kg) 4.8 / 5.2      Freight volume (m<sup>3</sup>) 0.45 / 6      Fabric required 500x1300/1500 mm

Art.no.	Description	Cat. A	Cat. B	Cat. C	Cat. D	Cat. E	Cat. F
		21	22	23	24	25	26
106A232120	Chair, Back in wood, Upholstered seat, Powder coated* frame	416	453	468	488	513	612
106A232140	Chair, Back in wood, Upholstered seat, Chromed frame	454	498	513	534	561	670
106B232120	Armchair, Back and armrests in wood, Upholstered seat, Powder coated* frame	620	658	671	699	721	813
106B232140	Armchair, Back and armrests in wood, Upholstered seat, Chromed frame	677	718	732	763	786	886

**CAMPUS CHAIR / ARMCHAIR, FULLY UPHOLSTERED**

Weight (kg) 4.8 / 5.2      Freight volume (m<sup>3</sup>) 0.45 / 6      Fabric required 550x1300/1500 mm

Art.no.	Description	Cat. A	Cat. B	Cat. C	Cat. D	Cat. E	Cat. F
		21	22	23	24	25	26
106A240120	Fully upholstered, Powder coated* frame	431	472	488	511	535	659
106A240140	Fully upholstered, Chromed frame	473	520	534	559	586	722
106B240120	Armchair, Armrests in wood, Fully upholstered, Powder coated* frame	653	699	712	735	764	879
106B240140	Armchair, Armrests in wood, Fully upholstered, Chromed frame	712	763	777	801	834	959

## ADDITIONAL OPTION CAMPUS 4-LEG

Art.no.	Description	Price 10
144M810220	Additional set-up cost Select Color/ color	353
106M510110	Writing table, incl. Armrest in black Polyurethane	250
144M410217	Campus Original armrest, black polyamide	35
144M410310	Campus Air armrest, polyamide, suspendable	35
144M211410	Teflon glides	13
144M210510	Steel feet	13
144M215310	Felt glides	13
144M211610	Rubber feet	13
144M610410	Linking device Quick Lock	58
144K310217	Transport trolley Campus, black	1226
144M710410	Upholstery in two colors, supplements are based on the most expensive fabric group selected	70
144M710310	Stacking pad, used as protection when stacking.	39
144M616310	Chair hanging device, grey rubber lacquer	88
144M617210	Chair hanging device	88
144M810250	Stain standard Color	58

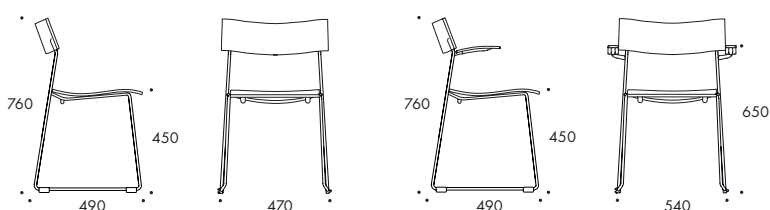

### CAMPUS CHAIR / ARMCHAIR, SLED BASE

Weight (kg) 5.1 / 5.6 Freight volume (m<sup>3</sup>) 0.45 / 6

Art.no.	Description	Price 80
106A325120	Chair, Seat and back in wood, Powder coated* frame	468
106A325140	Chair, Seat and back in wood, Chromed frame	508
106B325120	Armchair, Seat and back in wood, Armrests in polyamide, Powder coated* frame	557
106B325140	Armchair, Seat and back in wood, Armrests in polyamide, Chromed frame	603

### CAMPUS CHAIR / ARMCHAIR, SLED BASE, UPHOLSTERED SEAT

Weight (kg) 5.1 / 5.6 Freight volume (m<sup>3</sup>) 0.45 / 6 Fabric required 500x1300/1500 mm

Art.no.	Description	Cat. A	Cat. B	Cat. C	Cat. D	Cat. E	Cat. F
		21	22	23	24	25	26
106A332120	Chair, Back in wood, Upholstered seat, Powder coated* frame	489	528	541	565	591	695
106A332140	Chair, Back in wood, Upholstered seat, Chromed frame	534	577	591	616	644	757
106B332120	Armchair, Back in wood, Armrests in polyamide, Upholstered seat, Powder coated* frame	561	598	613	634	660	766
106B332140	Armchair, Back in wood, Armrests in polyamide, Upholstered seat, Chromed frame	612	652	669	692	721	835

### CAMPUS CHAIR / ARMCHAIR, SLED BASE, FULLY UPHOLSTERED

Weight (kg) 5.1 / 5.6 Freight volume (m<sup>3</sup>) 0.45 / 6 Fabric required 550x1300/1500 mm

Art.no.	Description	Cat. A	Cat. B	Cat. C	Cat. D	Cat. E	Cat. F
		21	22	23	24	25	26
106A340120	Chair, Fully upholstered, Powder coated* frame	482	526	539	560	585	709
106A340140	Chair, Fully upholstered, Chromed frame	528	575	591	613	640	776
106B340120	Armchair, Armrests in polyamide, Fully upholstered, Powder coated* frame	549	593	606	629	655	776
106B340440	Armchair, Armrests in polyamide, Fully upholstered, Chromed frame	601	650	664	688	717	849

## ADDITIONAL OPTION CAMPUS SLED BASE

Art.no.	Description	Price 10
144M810220	Additional set-up cost Select Color/ color	353
144M212310	Felt glides	13
144M610510	Linking device sled frame	23
144K310417	Transport trolley	795
144M710410	Upholstery in two colors, supplements are based on the most expensive fabric group selected	70
144M710310	Stacking pad, used as protection when stacking.	39
144M617210	Chair hanging device	88
144M810250	Stained standard Color	58

# CAMPUS AIR

Design Johannes Foersom & Peter HiortLorenzen 2010/2013



## Seat and back

Glass-fibre reinforced polyamide in standard colours light beige, grey, black, grey green, blue, orange, yellow brown & yellow. Upholstered seat as an alternative.

## Frame

4-leg frame in Ø16 mm powder coated or chrome-plated steel tubing. Felt glides. Sled frame in Ø11 mm powder coated or chrome-plated steel wire. Plastic glides.

## Outdoor use

Campus Air chair is available with frame for outdoor use at an additional cost.

## Armrests

In matching colour.

Linking and stacking

Chair: stackable and linkable c/c 521 mm, Armchair: stackable and linkable c/c 557 mm.

Note! For long-term stacking of upholstered seats, the stacking pad is recommended.

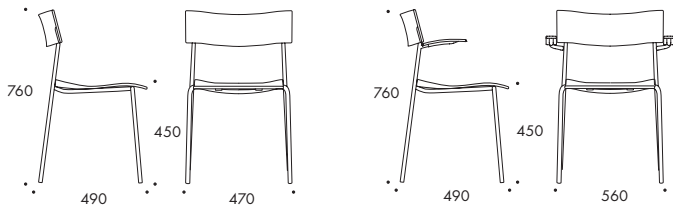

## When ordering, specify:

Colour seat and back

Fabric and colour

Colour powder coat

\*Additional set-up cost applies for powder coat in our Select Color range, see options.

## CAMPUS AIR CHAIR / ARMCHAIR

Weight (kg) 4.0 / 5.0 Freight volume (m³) 0.45 / 6

Art.no.	Description	Price 10
107A224120	Chair, Seat and back in polyamide, Powder coated* frame	235
107A224140	Chair, Seat and back in polyamide, Chromed frame	251
107B224120	Armchair, Seat, back and armrests in polyamide, Powder coated* frame	329
107B224140	Armchair, Seat, back and armrests in polyamide, Chromed frame	343

## CAMPUS AIR CHAIR / ARMCHAIR, UPHOLSTERED SEAT

Weight (kg) 4.0 / 5.0 Freight volume (m³) 0.45 / 6 Fabric required 500x1300/1500 mm

Art.no.	Description	Cat. A	Cat. B	Cat. C	Cat. D	Cat. E	Cat. F
		21	22	23	24	25	26
107A231120	Chair, Back in polyamide, Upholstered seat, Powder coated* frame	330	368	381	397	426	518
107A231140	Chair, Back in polyamide, Upholstered seat, Chromed frame	344	384	397	415	446	541
107B231120	Armchair, Back and armrests in polyamide, Upholstered seat, Powder coated* frame	441	477	492	538	562	630
107B231140	Armchair, Back and armrests in polyamide, Upholstered seat, Chromed frame	461	500	514	561	587	658

## ADDITIONAL OPTION CAMPUS AIR 4-LEG

Art.no.	Description	Price 10
144M810220	Additional set-up cost Select Color/ color	353
144M211410	Teflon glides	13
144M210510	Steel feet	13
144M218310	Plastic glides	13
144M211610	Rubber feet	13
144M610410	Linking device Quick Lock	58
144K310217	Transport trolley Campus, black	1226
144M410217	Campus Original armrest, black polyamide	35
144M810320	Frame for outdoor use	115
144M616310	Chair hanging device, grey rubber lacquer	88
144M617210	Chair hanging device	88

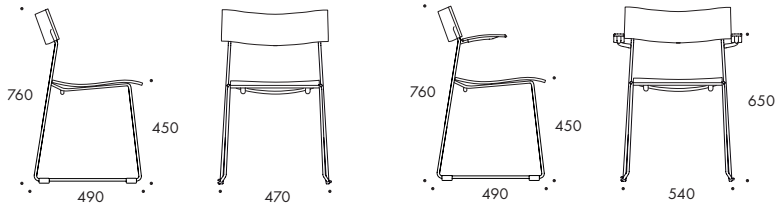

**CAMPUS AIR CHAIR / ARMCHAIR, SLED BASE**

Weight (kg) 5.1 / 5.6 Freight volume (m<sup>3</sup>) 0.29 / 4

Art.no.	Description	Price
107A324120	Chair, Seat and back in polyamide, Powder coated* frame	281
107A324140	Chair, Seat and back in polyamide, Chromed frame	281
107B324120	Armchair, Seat, back and armrests in polyamide, Powder coated* frame	348
107B324140	Armchair, Seat, back and armrests in polyamide, Chromed frame	364

**CAMPUS AIR CHAIR / ARMCHAIR, SLED BASE, UPHOLSTERED SEAT**

Weight (kg) 5.1 / 5.6 Freight volume (m<sup>3</sup>) 0.45 / 6 Fabric required 500x1300/1500 mm

Art.no.	Description	Cat. A	Cat. B	Cat. C	Cat. D	Cat. E	Cat. F
		21	22	23	24	25	26
107A331115	Chair, Back in polyamide, Upholstered seat, Powder coated* frame	379	414	427	448	493	566
107A331140	Chair, Back in polyamide, Upholstered seat, Chromed frame	396	433	447	468	515	592
107B331120	Armchair, Back and armrests in polyamide, Upholstered seat, Powder coated* frame	499	532	541	562	591	672
107B331140	Armchair, Back and armrests in polyamide, Upholstered seat, Chromed frame	521	557	566	587	618	703

**ADDITIONAL OPTION CAMPUS AIR SLED BASE**

Art.no.	Description	Price
144M810220	Additional set-up cost Select Color/ color	353
144M212310	Felt glides sled frame	13
144M610510	Linking device sled frame	23
144K310417	Transport trolley	795
144M810320	Frame for outdoor use	115
144M617210	Chair hanging device, grey rubber lacquer	88

# CAROUSEL

Design Gunilla Allard 2018

## Seat shell

Moulded back with high resilient polyurethane foam. Seat of moulded plywood with high resilient polyurethane foam.

## Frame

4-feet or 5-feet swivel base, of polished or powder coated aluminum. Pillar always in chrome or black texture powder coat. Incl. 360° comfort tilt.

Glides and castors

Glides in matching powder coat or chrome, alt. castors in black, graphite, white or polished.

## Additional

Height adjustable frame (not for 4-feet with castors).

## When ordering, specify:

Fabric and colour

Colour powder coat

Glides or castors

Colour casters

Colour pillar

\* Additional set-up cost applies for powder coat in our Select Color range, see options.

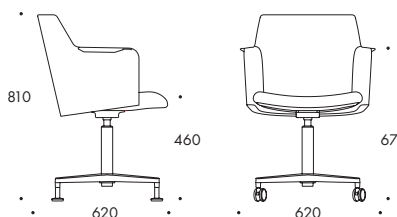

## CAROUSEL ARMCHAIR, 4-FEET

Weight (kg) 11.5      Freight volume (m³) 0.41      Fabric required 1400x1400 mm

Art.no.	Description	Cat. A	Cat. B	Cat. C	Cat. D	Cat. E	Cat. F
		21	22	23	24	25	26
108B440220	Armchair, Fully upholstered, Powder coated* swivel base	1414	1518	1565	1613	1710	2440
108B440260	Armchair, Fully upholstered, Polished swivel base	1414	1518	1565	1613	1710	2440

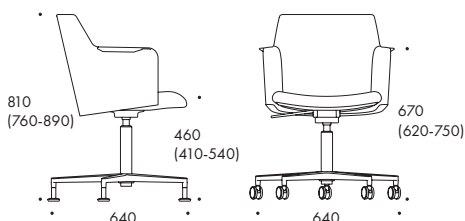

## CAROUSEL ARMCHAIR, 5-FEET

Weight (kg) 11.5      Freight volume (m³) 0.41      Fabric required 1400x1400 mm

Art.no.	Description	Cat. A	Cat. B	Cat. C	Cat. D	Cat. E	Cat. F
		21	22	23	24	25	26
108B540220	Armchair, Fully upholstered, Powder coated* swivel base	1451	1555	1605	1655	1751	2489
108B540260	Armchair, Fully upholstered, Polished swivel base	1451	1555	1605	1655	1751	2489

## ADDITIONAL OPTIONS CAROUSEL

Art.no.	Description	Price	Cat. F
		10	26
144M810220	Additional set-up cost Select Color/ color	353	
108M310210	Height adjustable pillar, For 4-feet only in combination with glides	42	
108M710110	Caroussel 2-colored upholstery. Calculated on the higher fabric category	143	
108M710210	Leather upholstered seat		281
108M710310	Leather upholstered inside back		578
108M710410	Leather upholstered outside back		721
108M710510	Leather-clad armrests & half inside back		290

**Seat shell**

Moulded Polypropylene. Standard colours light beige, grey, black, grey green, blue, orange, yellow brown & yellow. Alternatives: upholstered seat or fully upholstered.

**Frame**

4-leg frame in Ø14 mm powder coated or chrome-plated steel tubing. Plastic glides. 5-feet swivel base, height adjustable in Ø40 mm pillar in powder coated or polished aluminium. Castors.

**Glides and castors**

Black glides. Castors in black or polished.

Armrests and stacking protection

Matching colour on armrests. Black stacking protection in ABS.

**Linking and stacking**

Chair with 4-leg frame or sled frame is stackable and linkable.

Armchair with 4-leg frame or sled frame is stackable and linkable armchair-chair-armchair.

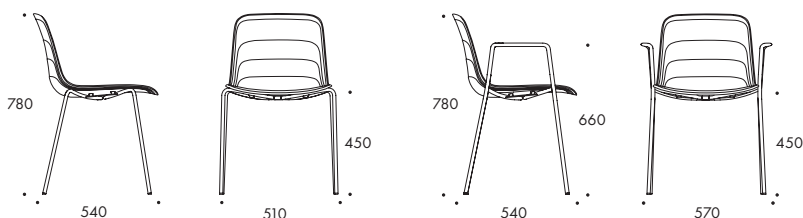

**When ordering, specify:**

Colour seat shell

Fabric and colour

Colour powder coat

Colour casters

\* Additional set-up cost applies for powder coat in our Select Color range, see options.

**GRADE CHAIR / ARMCHAIR**

Weight (kg) 4.5 / 5.0 Freight volume (m³) 0.41 / 4

Art.no.	Description	Price
111A224120	Chair, Seat shell in polypropylene, Powder coated* frame	233
111A224140	Chair, Seat shell in polypropylene, Chromed frame	257
111B224120	Armchair, Seat shell in polypropylene, Powder coated* frame	371
111B224140	Armchair, Seat shell in polypropylene, Chromed frame	390

**GRADE CHAIR / ARMCHAIR, UPHOLSTERED SEAT**

Weight (kg) 4.5 / 5.0 Freight volume (m³) 0.41 / 4 Fabric required 500x1400 mm

Art.no.	Description	Cat. A	Cat. B	Cat. C	Cat. D	Cat. E	Cat. F
		21	22	23	24	25	26
111A231120	Chair, Seat shell in polypropylene, Upholstered seat, Powder coated* frame	355	421	437	455	487	585
111A231140	Chair, Seat shell in polypropylene, Upholstered seat, Chromed frame	388	461	479	498	533	640
111B231120	Armchair, Seat shell in polypropylene, Upholstered seat, Powder coated* frame	488	554	570	586	619	718
111B231140	Armchair, Seat shell in polypropylene, Upholstered seat, Chromed frame	534	606	624	642	678	787

**GRADE CHAIR / ARMCHAIR, FULLY UPHOLSTERED**

Weight (kg) 4.5 / 5.0 Freight volume (m³) 0.41 / 4 Fabric required 1000x1400 mm

Art.no.	Description	Cat. A	Cat. B	Cat. C	Cat. D	Cat. E	Cat. F
		21	22	23	24	25	26
111A240120	Chair, Fully upholstered, Powder coated* frame	545	593	627	660	727	908
111A240140	Chair, Fully upholstered, Chromed frame	592	653	691	727	800	999
111B240120	Armchair, Fully upholstered, Powder coated* frame	645	719	754	787	854	1036
111B240140	Armchair, Fully upholstered, Chromed frame	710	791	829	866	940	1140

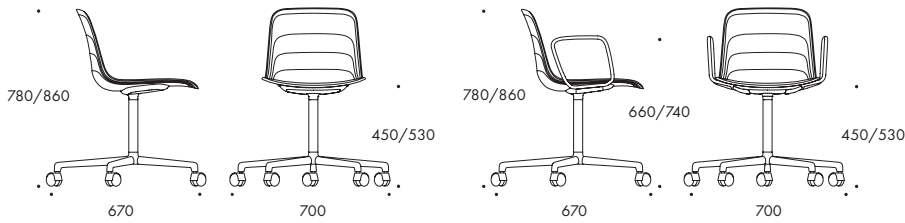

### GRADE CHAIR / ARMCHAIR, 5-FEET

Weight (kg) 7.6 / 9.1 Freight volume (m³) 0.42

Art.no.	Description	Price 10
111A524120	Chair, Seat shell in polypropylene, Powder coated* swivel base with casters	657
111A524160	Chair, Seat shell in polypropylene, Polished aluminium swivel base with polished casters	732
111B524120	Armchair, Seat shell in polypropylene, Powder coated* swivel base with casters	748
111B524160	Armchair, Seat shell in polypropylene, Polished aluminium swivel base with polished casters	823

### GRADE CHAIR / ARMCHAIR, 5-FEET, UPHOLSTERED SEAT

Weight (kg) 7.6 / 9.1 Freight volume (m³) 0.42 Fabric required 500x1400 mm

Art.no.	Description	Cat. A 21	Cat. B 22	Cat. C 23	Cat. D 24	Cat. E 25	Cat. F 26
111A531120	Chair, Seat shell in polypropylene, Upholstered seat, Powder coated* swivel base with casters	782	847	864	879	913	1010
111A531160	Chair, Seat shell in polypropylene, Upholstered seat, Polished aluminium swivel base with polished casters	856	921	939	954	986	1085
111B531120	Armchair, Seat shell in polypropylene, Upholstered seat, Powder coated* swivel base with casters	871	939	953	969	1003	1101
111B531160	Armchair, Seat shell in polypropylene, Upholstered seat, Polished aluminium swivel base with polished casters	946	1012	1029	1045	1077	1175

### GRADE CHAIR / ARMCHAIR, 5-FEET, FULLY UPHOLSTERED

Weight (kg) 7.6 / 9.1 Freight volume (m³) 0.42 Fabric required 1000x1400 mm

Art.no.	Description	Cat. A 21	Cat. B 22	Cat. C 23	Cat. D 24	Cat. E 25	Cat. F 26
111A540120	Chair, Fully upholstered, Powder coated* swivel base with casters	973	1048	1083	1115	1187	1375
111A540160	Chair, Fully upholstered, Polished aluminium swivel base with polished casters	1049	1123	1159	1192	1264	1450
111B540120	Armchair, Fully upholstered, Powder coated* frame with casters	1063	1137	1173	1207	1278	1466
111B540160	Armchair, Fully upholstered, Polished aluminium swivel base with polished casters	1139	1213	1247	1283	1353	1542

### ADDITIONAL OPTIONS GRADE

Art.no.	Description	Price 10
144M810220	Additional set-up cost Select Color/ color	353
144K310417	Transport trolley for 4 legs	795
144M610110	Linking device Grade for 4 legs	36
144M213410	Teflon glides for 4 legs	13
144M216310	Felt glides for 4 legs	13
144M210210	Replacement from glides to casters for 5-feet	60



**Seat and back**

Moulded oak or ash or in standard colours light beige, grey, black, grey green, blue, orange, yellow brown & yellow Polypropylene.

**Frame**

Legs of aluminium tubing Ø35 mm powder coated

Seat frame and armrests in matching color, for wooden seat and back specify desired plastic color of frame and armrests.

**Linking and stacking**

Stackable incl. stacking protection, Linkable (chair - chair) alternatively (armchair - chair - armchair)



**When ordering, specify:**

Wood for seat and back

Colour powder coat

Colour Seat frame and armrests

\*Additional set-up cost applies for powder coat in our Select Color range, see options.

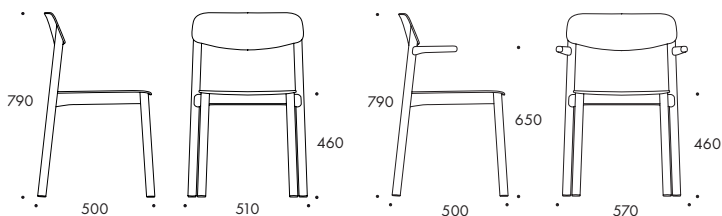

**PENNE CHAIR / ARMCHAIR, SEAT & BACK IN WOOD**

Weight (kg) 4.2 / 4.5      Freight volume (m³) 0.41 / 4

Art.no.	Description	Price
		80
113A225120	Chair, Seat & back in wood, Seat frame in polyamide, Powder coated* frame	542
113B225120	Armchair, Seat & back in wood, Seat frame and armrests in polyamide, Powder coated* frame	594

**PENNE CHAIR / ARMCHAIR, SEAT & BACK IN POLYPROPYLENE**

Weight (kg) 4.4 / 4.7      Freight volume (m³) 0.41 / 4

Art.no.	Description	Price
		10
113A224120	Chair, Seat & back in Polypropylene, Seat frame in polyamide, Powder coated* frame	343
113B224120	Armchair, Seat & back in Polypropylene, Seat frame and armrests in polyamide, Powder coated* frame	408

ADDITIONAL OPTIONS PENNE		Price
Art.no.	Description	10
144M810220	Additional set-up cost Select Color/ color	353
113M810220	Frame for outdoor use	115
144K310417	Trolley	795
144M810250	Stained standard Color	58
113M210210	Felt glides	13
113M210310	Teflon glides	13
113M610110	Linking device	36

# PLANKA

Design Börge Lindau & Bo Lindekrantz 1985



### Seat & back

Back in black or white laquered wood or completely leather covered.

Seat in powder coated perforated sheet metal or upholstered in leather. Neck cushion in black leather.

### Frame

Frame for seat and neck cushion in chrome.

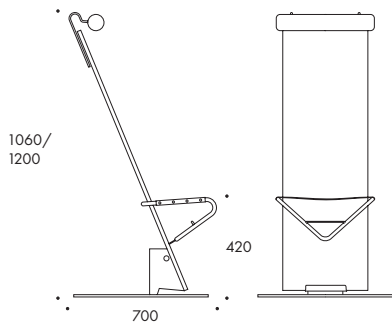

## PLANKA CHAIR

Weight (kg) 14.0      Freight volume (m<sup>3</sup>) 0.40

Art.no.	Description	Price
114A120115	White lacquered wooden back, Seat & footplate in white, Black leather neck cushion	10 On request
114A120117	Black lacquered wooden back, Seat & footplate in black, Black leather neck cushion	10 On request

**Seat and back**

Upholstered seat and back with padding of moulded cold foam.

**Frame**

Frame in Ø18 mm powder coated or chrome-plated steel tubing. Spring steel in the back.  
4-leg frame with plastic glides.  
5-feet swivel frame with castors in chrome.

**Armrests**

Armrests in dark or light Woodfibre. Cover sleeve in dark or light plastic. Dark by default.

**Linking and stacking**

4-leg framed chair is stackable with built-in stacking protection. Chair linkable C/C 521 mm and Armchair C/C 557 mm.

**Note!** For long-term stacking of upholstered seats, the stacking pad is recommended.

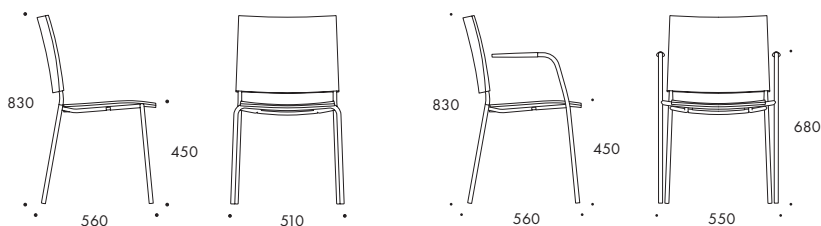

When ordering, specify:

Fabric and colour

Colour powder coat

Colour armrests & cover sleeve

\*Additional set-up cost applies for powder coat in our Select Color range, see options.

**SPIRA CHAIR / ARMCHAIR, FULLY UPHOLSTERED**

Weight (kg) 5.8 / 6.9 Freight volume (m³) 0.41 / 3 Fabric required 950x1300/1500 mm

Art.no.	Description	Cat. A	Cat. B	Cat. C	Cat. D	Cat. E	Cat. F
		21	22	23	24	25	26
115A240120	Fully upholstered, Powder coated* frame	625	660	675	685	722	828
115A240140	Fully upholstered, Chromed frame	657	694	709	719	758	871
115B240120	Fully upholstered, Powder coated* frame	678	711	725	735	769	876
115B240140	Fully upholstered, Chromed frame	712	748	762	773	808	921

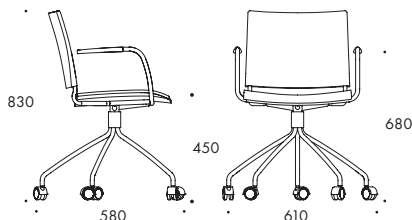

**SPIRA ARMCHAIR, 5-FEET, FULLY UPHOLSTERED**

Weight (kg) 9.5 / 11.0 Freight volume (m³) 0.50 Fabric required 1000x1300/1500 mm

Art.no.	Description	Cat. A	Cat. B	Cat. C	Cat. D	Cat. E	Cat. F
		21	22	23	24	25	26
115B540120	Fully upholstered, Powder coated* swivel base with chromed casters	982	1084	1109	1134	1182	1304
115B540140	Fully upholstered, Chromed swivel base with chromed casters	1031	1139	1165	1191	1242	1370

ADDITIONAL OPTIONS SPIRA 5-FEET		Price
Art.no.	Description	10
144M810220	Additional set-up cost Select Color/ color	353
144M710410	Upholstery in two colors, supplements are based on the most expensive fabric group selected	70
144M217310	Felt glides	13
144M212610	Rubber feet	13
144M214410	Teflon glides	13
115M710210	Moisture barrier - seat	96

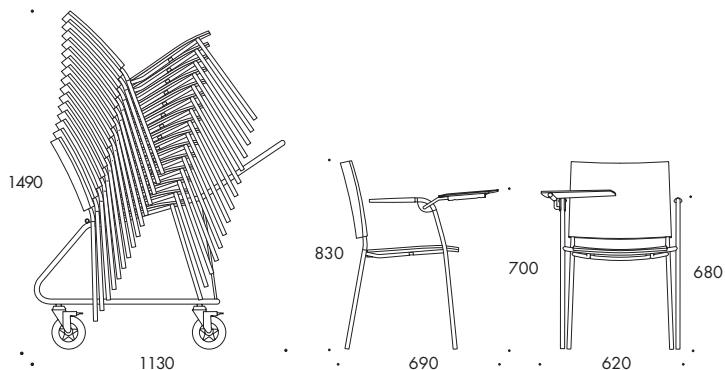

#### ADDITIONAL OPTIONS SPIRA 4-LEG

Weight (kg) 11.0 Freight volume (m<sup>3</sup>) 0.50

Art.no.	Description	Price 10
144K310317	Transport trolley, black	827
144M610410	Linking device Quick Lock	58
115M510110	Laptop table for armchair, right or left	219
144M710310	Stacking pad, used as protection when stacking.	39

#### ADDITIONAL OPTIONS SPIRA QUILT

Art.no.	Description	Cat. A	Cat. B	Cat. C	Cat. D	Cat. E	Cat. F
		21	22	23	24	25	26
115M730110	Quilted seat	70	70	70	70	70	109
115M740110	Quilted seat and back	103	103	103	103	103	146

# TABURETT PLUS

Design Peter Andersson 2024



## Seat & back

Consumer-recycled ABS-plastic, in standard colours light beige, grey, black, grey green, blue, orange, yellow brown & yellow.

Upholstered seat as an alternative. Details on the back and seat in die-cast zinc that match the frame's finish.

Sound-absorbing felt made of recycled PET under the seat (approved by Möbelfakta) at additional cost.

## Frame

4-leg frame in Ø16mm powder coated or chrome-plated steel tubing. Black glides made of recycled plastic.

Frame for outdoor use at additional cost.

## Stacking

Stackable



When ordering, specify:

Colour seat

Fabric and colour

Colour powder coat

\*Additional set-up cost applies for powder coat in our Select Color range, see options.

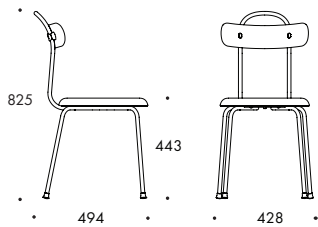

## TABURETT PLUS CHAIR

Weight (kg) 3.9      Freight volume (m³) 0.43 / 5

Art.no.	Description	Price
148A224120	Chair, Seat and back in ABS plastic, Powder coated* frame	307
148A224140	Chair, Seat and back in ABS plastic, Chromed frame	378

## TABURETT PLUS CHAIR, UPHOLSTERED SEAT

Weight (kg) 3.9      Freight volume (m³) 0.43 / 5      Fabric required 550x1400 mm

Art.no.	Description	Cat. A	Cat. B	Cat. C	Cat. D	Cat. E	Cat. F
148A231120	Chair, Back in ABS plastic, Upholstered seat, Powder coated* frame	21	22	23	24	25	26
148A231140	Chair, Back in ABS plastic, Upholstered seat, Chromed frame	378	402	414	426	461	516
		449	473	485	496	539	604

## ADDITIONAL OPTIONS TABURETT PLUS

Art.no.	Description	Price
148M710110	Sound-absorbing felt pad under seat	10
144M215310	Felt glides	24
144M810320	Frame for outdoor use	13
144M810220	Additional set-up cost Select Color/ color	115
		353

## X75-2

Design Börge Lindau & Bo Lindekrantz 1972

### Seat & back

Back in linen natural or black canvas. Seat with support fabric incl. Pad in linen natural or black canvas, reinforcement in matching leather.

### Frame

Foldable frame in Ø25 mm steel tubing in chromed or powder coat.  
Cross rail in black powder coat.

### When ordering, specify:

Linen or Canvas

Colour powder coat

\* Additional set-up cost applies for powder coat in our Select Color range, see options.

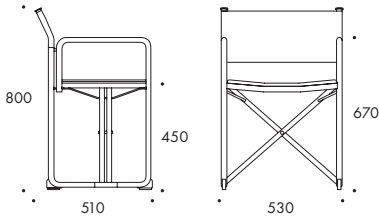

### X75-2 ARMCHAIR

Weight (kg) 7.9      Freight volume (m<sup>3</sup>) 0.20

Art.no.	Description	Price
117B340140	Armchair, Fully upholstered, Chromed frame	1166
117B340120	Armchair, Fully upholstered, Powder coated* frame	979

### ADDITIONAL OPTIONS & ACCESSORIES X75-2

Art.no.	Description	Price
144M810220	Additional set-up cost Select Color/ color	353
117M740310	X75-2 Replacement upholstery canvas/ linen	451

# A22

Design Anya Sebton 2022



### Seat

3mm powder coated perforated sheet steel.  
Loose reversible cushion and cushion for outdoor use as an option.

### Frame

Ø 25 & 20 mm powder coated steel tube. Footrest of 15 mm galvanized steel tube. Glides.  
Stackable.

### Outdoor use

A22 can be used both indoors and outdoors.

When ordering, specify:

Fabric and colour

Colour powder coat

\* Additional set-up cost applies for powder coat in our Select Color range, see options.

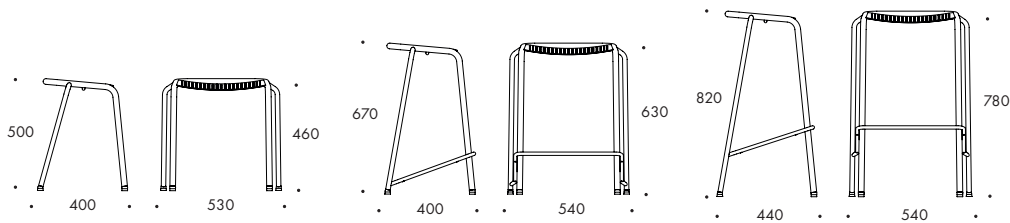

### A22 STOOL, UNUPHOLSTERED, H460

Weight (kg) 5.0      Freight volume (m³) 0.33      Fabric required 450x1300/1400/1500 mm

Art.no.	Description	Price
137D220420	Powder coated* frame, H460	10 493

### A22 BARSTOOL, UNUPHOLSTERED, H630

Weight (kg) 6.5      Freight volume (m³) 0.50      Fabric required 450x1300/1400/1500 mm

Art.no.	Description	Price
137C220520	Powdercoated* frame H630	10 486

### A22 BARSTOOL, UNUPHOLSTERED, H780

Weight (kg) 7.0      Freight volume (m³) 0.50      Fabric required 450x1300/1400/1500 mm

Art.no.	Description	Price
137C220620	Powdercoated* frame H780	10 529

### ADDITIONAL OPTIONS A22

Art.no.	Description	Price	Cat. A	Cat. B	Cat. C	Cat. D	Cat. E	Cat. F
		10	21	22	23	24	25	26
144M810220	Additional set-up cost Select Color/ color	353						
137M740110	Detachable cushion		204	225	258	278	307	350
137M740210	Detachable cushion for outdoor use. Fabric Silvertex Graphite			222				
137M740310	Detachable cushion for outdoor use. Fabric Silvertex Macadamia			222				
137M710110	Addition for detachable cushion in two Colors, supplements are based on the most expensive fabric group selected	74						

**Seat**

Seat of moulded wood with cast black polyurethane or upholstered seat of moulded wood with moulded cold foam.

**Frame**

Ø22 mm powder coated or chrome-plated steel tubing. Footrest always in chrome. Plastic glides.

Stool at seat height 460 mm, Barstool in seating heights 630 & 780 mm. Suspensible with anti-slip protection.

When ordering, specify:

Fabric and colour

Colour powder coat

\*Additional set-up cost applies for powder coat in our Select Color range, see options.

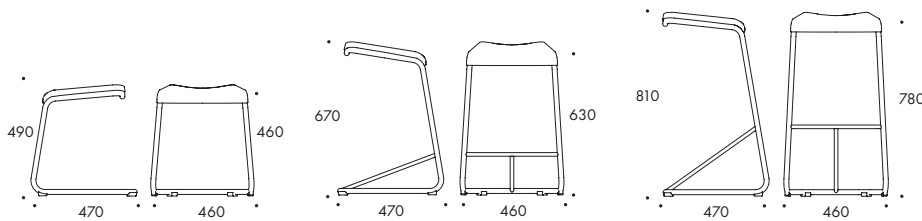

**ADD STOOL & BARSTOOL, PUR, H460 / H630 / H780**

Weight (kg) 4.0 / 4.8 / 5.0      Freight volume (m³) 0.15 / 0.15 / 0.18

Art.no.	Description	Price 10
101D621120	Seat in black Polyurethane, Powder coated* frame H460	391
101D621140	Seat in black Polyurethane, Chrome frame H460	429
101C621220	Seat in black Polyurethane, Powder coated* frame H630	420
101C621240	Seat in black Polyurethane, Chrome frame H630	466
101C621320	Seat in black Polyurethane, Powder coated* frame H780	466
101C621340	Seat in black Polyurethane, Chrome frame H780	513

**ADD STOOL & BARSTOOL, UPHOLSTERED SEAT, H460 / H630 / H780**

Weight (kg) 4.0 / 4.8 / 5.0      Freight volume (m³) 0.15 / 0.15 / 0.18  
 Fabric required 500x1300/1400/1500 mm

Art.no.	Description	Cat. A	Cat. B	Cat. C	Cat. D	Cat. E	Cat. F
		21	22	23	24	25	26
101D630120	Upholstered seat, Powder coated* frame H460	379	444	454	467	490	644
101D630140	Upholstered seat, Chrome frame H460	415	464	475	488	513	673
101C630220	Upholstered seat, Powder coated* frame H630	409	447	456	467	486	609
101C630240	Upholstered seat, Chrome frame H630	454	496	506	518	539	676
101C630320	Upholstered seat, Powder coated* frame H780	454	496	506	518	539	676
101C630340	Upholstered seat, Chrome frame H780	500	546	557	570	593	744

**ADDITIONAL OPTIONS ADD**

Art.no.	Description	Price 10
144M810220	Additional set-up cost Select Color/ color	353



## ADD MOVE

Design Anya Sebton 2016



### Seat and back

Unupholstered, upholstered seat of fully upholstered.

Seat of moulded wood with cast black polyurethane or upholstered seat of moulded wood with moulded cold foam.

Back of black polyurethane alternative upholstered.

### Frame

Ø22 mm powder coated or chrome-plated steel tubing.

Castors in black or chrome. Seat height 460 mm.

Suspendable with built-in anti-slip protection.

When ordering, specify:

Fabric and colour

Colour powder coat

Colour casters

\*Additional set-up cost applies for powder coat in our Select Color range, see options.

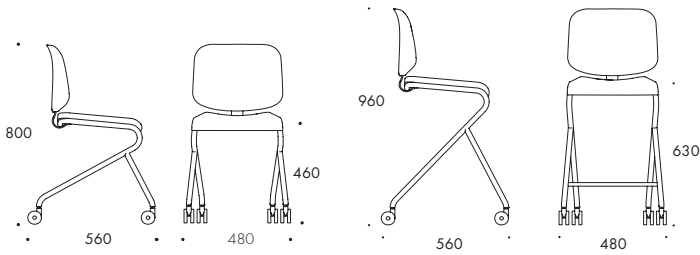

### ADD MOVE, CHAIR & BARSTOOL, UPHOLSTERED SEAT, H460 / H780

Weight (kg) 4.0 Freight volume (m<sup>3</sup>) 0.15 Fabric required 500x1300/1400/1500 mm

Art.no.	Description	Cat. A	Cat. B	Cat. C	Cat. D	Cat. E	Cat. F
		21	22	23	24	25	26
102D230120	Upholstered seat, Powder coated* frame H460	567	612	621	632	655	795
102D230140	Upholstered seat, Chrome frame H460	613	662	672	683	708	859
102C230220	Upholstered seat, Powder coated* frame H630	612	655	665	677	696	838
102C230240	Upholstered seat, Chrome frame H630	656	701	712	725	745	897

### ADD MOVE, CHAIR & BARSTOOL, FULLY UPHOLSTERED, H460 / H780

Weight (kg) 6.0 Freight volume (m<sup>3</sup>) 0.30 Fabric required 600x1300/1400/1500 mm

Art.no.	Description	Cat. A	Cat. B	Cat. C	Cat. D	Cat. E	Cat. F
		21	22	23	24	25	26
102A240120	Fully upholstered, Powder coated* frame H460	855	901	914	925	950	1132
102A240140	Fully upholstered, Chrome frame H460	946	997	1010	1023	1050	1251
102C240220	Fully upholstered, Powder coated* frame H630	887	930	940	950	972	1134
102C240240	Fully upholstered, Chrome frame H630	941	986	997	1008	1031	1202

### ADDITIONAL OPTIONS ADD MOVE

Art.no.	Description	Price
144M810220	Additional set-up cost Select Color/ color	10 353

# CAMPUS AIR

Design Johannes Foersom & Peter HiortLorenzen 2008



## Seat and back

Glass-fibre reinforced polyamide in standard colours light beige, grey, black, grey green, blue, orange, yellow brown & yellow. Upholstered seat as an alternative.

## Frame

4-leg frame in Ø16 mm powder coated or chrome-plated steel tubing. Plastic glides. Seat height 630 or 780 mm.



When ordering, specify:

Colour seat and back

Fabric and colour

Colour powder coat

\*Additional set-up cost applies for powder coat in our Select Color range, see options.

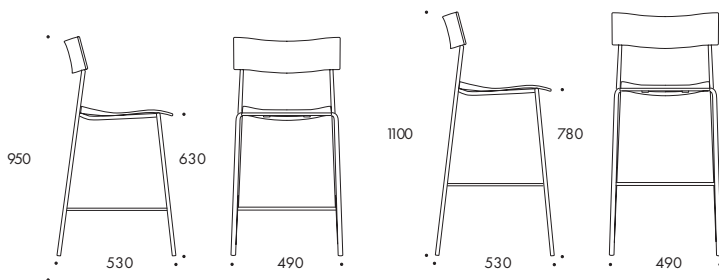

## CAMPUS AIR BARSTOOL, UNUPHOLSTERED, H630

Weight (kg) 6.0      Freight volume (m³) 0.30

Art.no.	Description	Price 10
107C224220	Seat and back in polyamide, Powder coated* frame H630	407
107C224240	Seat and back in polyamide, Chromed frame H630	424
107C224320	Seat and back in polyamide, Powder coated* frame H780	454
107C224340	Seat and back in polyamide, Chromed frame H780	475

## CAMPUS AIR BARSTOOL, UPHOLSTERED SEAT, H630

Weight (kg) 4.0      Freight volume (m³) 0.30      Fabric required 500x1300/1500 mm

Art.no.	Description	Cat. A	Cat. B	Cat. C	Cat. D	Cat. E	Cat. F
		21	22	23	24	25	26
107C231220	Back in polyamide, Upholstered seat, Powder coated* frame H630	503	540	553	570	598	691
107C231240	Back in polyamide, Upholstered seat, Chromed frame H630	527	565	578	596	625	722
107C231320	Back in polyamide, Upholstered seat, Powder coated* frame H780	552	590	601	619	647	738
107C231340	Back in polyamide, Upholstered seat, Chromed frame H780	577	616	629	647	677	773

## ADDITIONAL OPTIONS CAMPUS AIR BARSTOOL

Art.no.	Description	Price 10
144M810220	Additional set-up cost Select Color/ color	353
144M211410	Teflon glides	13
144M210510	Steel feet	13
144M215310	Felt glides	13
144M211610	Rubber feet	13

## S70-3

Design Börge Lindau & Bo Lindekrantz 1968



### Seat

Unupholstered seat in ash or upholstered seat. Seat lacquered in white, grey or black at an additional cost.

### Frame

Ø32 mm steel tubing in powder coated or chrome design. Footrest always chromed. Suspendable with anti-slip protection. Stackable for unupholstered seats. Seat height 630 mm.

When ordering, specify:

Fabric and colour

Colour powder coat

\*Additional set-up cost applies for powder coat in our Select Color range, see options.

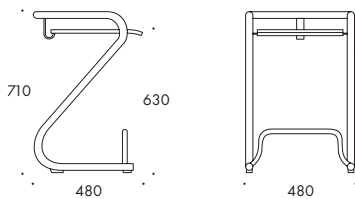

### S70-3 BARSTOOL, UNUPHOLSTERED

Weight (kg) 6.3 Freight volume (m³) 0.35 / 3

Art.no.	Description	Price
119C622120	Seat in wood, Powder coated* frame	80
119C622140	Seat in wood, Chromed frame	574
		683

### S70-3 BARSTOOL, UPHOLSTERED SEAT

Weight (kg) 6.3 Freight volume (m³) 0.35 / 3 Fabric required 1500x1300/1500 mm

Art.no.	Description	Cat. A	Cat. B	Cat. C	Cat. D	Cat. E	Cat. F
		21	22	23	24	25	26
119C630120	Upholstered seat, Powder coated* frame	652	669	705	732	769	887
119C630140	Upholstered seat, Chromed frame	783	803	847	879	924	1021

### ADDITIONAL OPTIONS S70-3 BARSTOOL

Art.no.	Description	Price
144M810220	Additional set-up cost Select Color/ color	10
119M810150	Stain S70-3 standard colors	353
		70

# TABURETT

Design Edvin Ståhl 1955/2015



## Seat

ABS-plastic in standard colours light beige, grey, black, grey green, blue, orange, yellow brown & yellow.

Alternative: upholstered seat. Embossed seat detail of powder coated or chromium plated die-cast zinc.

## Frame

Ø16mm powder coated or chrome plated steel tubing. Glides.

Seat height 460, 630 and 780mm. Height 460 mm is stackable.

## Note

Powder coat 800 black, is not recommended. Texture powder coat 801 black should be used instead.



When ordering, specify:

Colour seat

Fabric and colour

Colour powder coat

\*Additional set-up cost applies for powder coat in our Select Color range, see options.

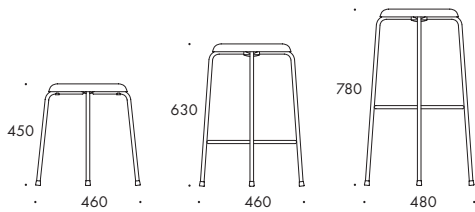

## TABURETT STOOL, UNUPHOLSTERED, H450

Weight (kg) 1.9      Freight volume (m<sup>3</sup>) 0.14 / 4

Art.no.	Description	Price
120D221120	Seat in ABS plastic, Powder coated* frame H450 mm	191
120D221140	Seat in ABS plastic, Chromed frame H450 mm	211
120C221220	Seat in ABS plastic, Powder coated* frame H630 mm	330
120C221240	Seat in ABS plastic, Chromed frame H630 mm	346
120C221320	Seat in ABS plastic, Powder coated* frame H780 mm	330
120C221340	Seat in ABS plastic, Chromed frame H780 mm	346

## TABURETT STOOL, UPHOLSTERED SEAT, H450

Weight (kg) 1.9      Freight volume (m<sup>3</sup>) 0.12      Fabric required 500x1400 mm

Art.no.	Description	Cat. A	Cat. B	Cat. C	Cat. D	Cat. E	Cat. F
		21	22	23	24	25	26
120D230120	Upholstered seat, Powder coated* frame H450 mm	287	357	374	390	423	474
120D230140	Upholstered seat, Chromed frame H450 mm	317	394	411	429	466	522
120C230220	Upholstered seat, Powder coated* frame H630 mm	429	496	515	532	566	616
120C230240	Upholstered seat, Chromed frame H630 mm	451	521	541	559	594	647
120C230320	Upholstered seat, Powder coated* frame H780 mm	429	496	515	532	566	616
120C230340	Upholstered seat, Chromed frame H780 mm	451	521	541	559	594	647

## ADDITIONAL OPTIONS TABURETT STOOL/BARSTOOL

Art.no.	Description	Price
144M810220	Additional set-up cost Select Color/ color	353
120M218310	Felt glides	15

**Seat & back**

Padding in both seat and back in moulded cold foam. Seat with Nozag elastic.  
NOTE! Cannot be upholstered in artificial leather.

**Frame**

Metal base in black powder coating with adjustable feet.



When ordering, specify:

Fabric and colour

\*Additional set-up cost applies for powder coat in our Select Color range, see options.

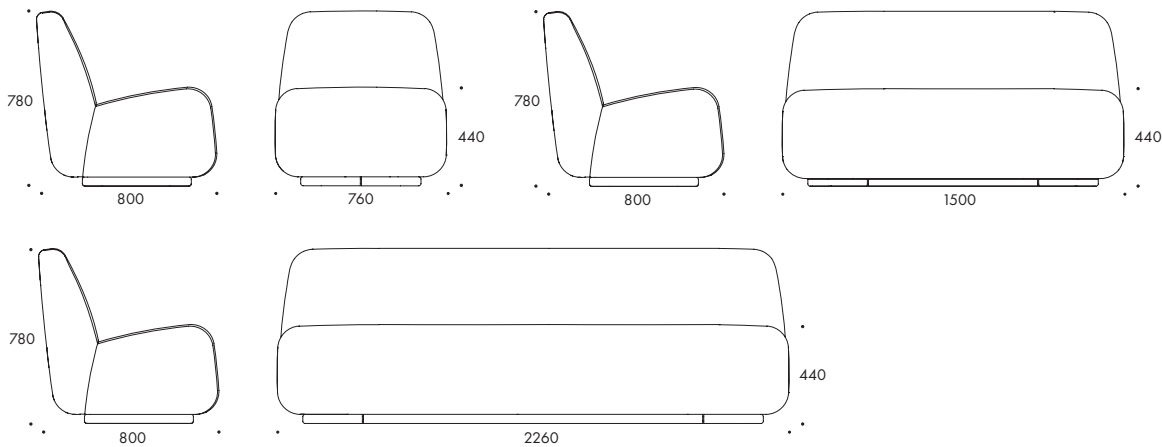

**APERI EASY CHAIR**

Weight (kg) 32.0      Freight volume (m³) 0.67      Fabric required 2600x1400 mm

Art.no.	Description	Cat. A	Cat. B	Cat. C	Cat. D	Cat. E	Cat. F
121E140117	Fully upholstered	21	22	23	24	25	26
		1601	1921	2000	2082	2240	3978

**APERI SOFA, 2-SEATER**

Weight (kg) 61.0      Freight volume (m³) 1.30      Fabric required 4000x1400 mm

Art.no.	Description	Cat. A	Cat. B	Cat. C	Cat. D	Cat. E	Cat. F
121G240117	Fully upholstered	21	22	23	24	25	26
		3113	3573	3678	3981	4157	7823

**APERI SOFA, 3-SEATER**

Weight (kg) 87.0      Freight volume (m³) 2.05      Fabric required 5500x1400 mm

Art.no.	Description	Cat. A	Cat. B	Cat. C	Cat. D	Cat. E	Cat. F
121G340117	Fully upholstered	21	22	23	24	25	26
		4667	5128	5231	5534	5710	10072

ADDITIONAL OPTIONS APERI SOFA/EASY CHAIR							Price
Art.no.	Description						10
144M710510	Seams in contrasting Colors, Easy Chair & footstool						178
144M710610	Seams in contrasting Colors, 2-seater sofa						251
144M710710	Seams in contrasting Colors, 3-seater sofa						267

**Seat and back**

Moulded shell of glass fibre reinforced polyurethane. Seat in plywood with moulded high resilient polyurethane foam. 3-seat sofa incl. pocket-springs.

**Frame**

Ø18 mm powder coated or chromed steel tubing. Glides.

When ordering, specify:

Fabric and colour

Colour powder coat

\*Additional set-up cost applies for powder coat in our Select Color range, see options.

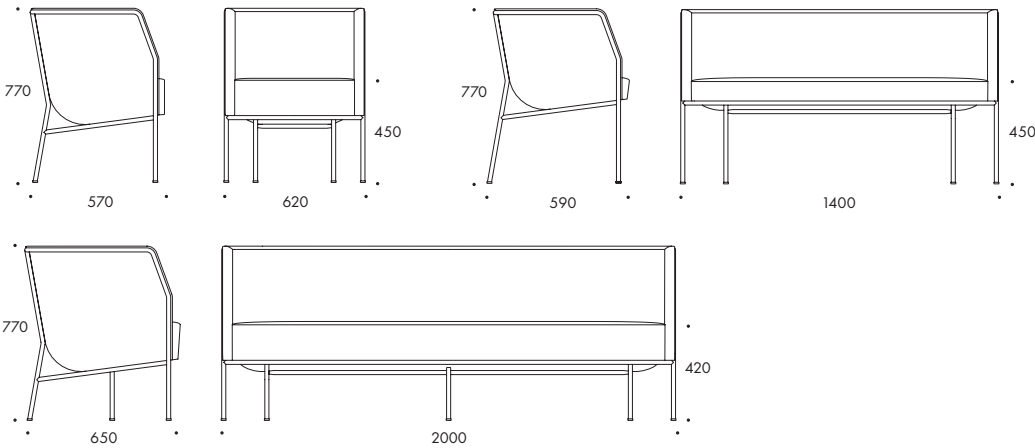

**CAJAL EASY CHAIR**

Weight (kg) 18.0      Freight volume (m³) 0.50      Fabric required 2100x1400 mm

Art.no.	Description	Cat. A	Cat. B	Cat. C	Cat. D	Cat. E	Cat. F
		21	22	23	24	25	26
122E140120	Fully upholstered, Powder coated* frame	2555	3069	3211	3350	3631	4890
122E140140	Fully upholstered, Chromed frame	2631	3222	3371	3517	3813	5136

**CAJAL SOFA, 2-SEATER**

Weight (kg) 40.0      Freight volume (m³) 1.60      Fabric required 3100x1400 mm

Art.no.	Description	Cat. A	Cat. B	Cat. C	Cat. D	Cat. E	Cat. F
		21	22	23	24	25	26
122G240120	Fully upholstered, Powder coated* frame	4078	4928	5141	5266	5537	7234
122G240140	Fully upholstered, Chromed frame	4418	5134	5354	5444	5634	7234

**CAJAL SOFA, 3-SEATER**

Weight (kg) 83.0      Freight volume (m³) 2.00      Fabric required 5200x1400 mm

Art.no.	Description	Cat. A	Cat. B	Cat. C	Cat. D	Cat. E	Cat. F
		21	22	23	24	25	26
122G340120	Fully upholstered, Powder coated* frame	5526	6084	6340	6595	7104	10648
122G340140	Fully upholstered, Chromed frame	5986	6637	6876	7105	7556	10648

**ADDITIONAL OPTIONS CAJAL SOFA & EASY CHAIR**

Art.no.	Description	Price
		10
144M810220	Additional set-up cost Select Color/ color	353
144M710110	2-Colored upholstery	139

# CINEMA

Design Gunilla Allard 1994



## Seat and back

Padding in moulded cold foam. Seat in Nozag springs. Leather-covered armrests, matching leather when leather upholstery, otherwise black leather as standard.

## Frame

Ø16 & Ø19 mm powder coated or chromed steel tubing. Glides.

When ordering, specify:

Fabric and colour

Colour powder coat

\*Additional set-up cost applies for powder coat in our Select Color range, see options.

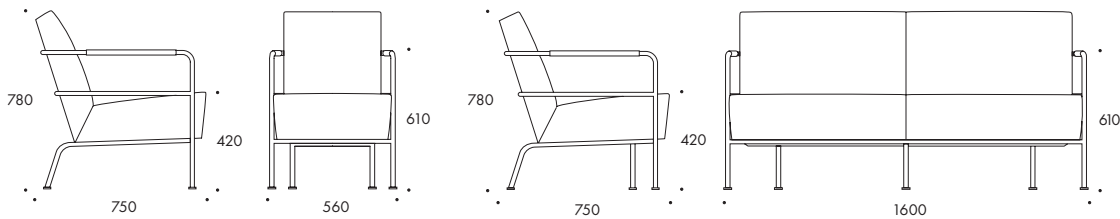

## CINEMA EASY CHAIR

Weight (kg) 16.6      Freight volume (m<sup>3</sup>) 0.50      Fabric required 1600x1300/1500 mm

Art.no.	Description	Cat. A	Cat. B	Cat. C	Cat. D	Cat. E	Cat. F
		21	22	23	24	25	26
124E140140	Fully upholstered, Chromed frame	2231	2438	2488	2592	2717	2991
124E140120	Fully upholstered, Powder coated* frame	2124	2322	2369	2468	2587	2848

## CINEMA SOFA

Weight (kg) 42.0      Freight volume (m<sup>3</sup>) 1.10      Fabric required 4500x1300/1500 mm

Art.no.	Description	Cat. A	Cat. B	Cat. C	Cat. D	Cat. E	Cat. F
		21	22	23	24	25	26
124G140140	Fully upholstered, Chromed frame	4731	5412	5568	6019	6280	7424
124G140120	Fully upholstered, Powder coated* frame	4337	4961	5104	5517	5757	7086

## ADDITIONAL OPTIONS CINEMA EASY CHAIR & SOFA

Art.no.	Description	Price
		10
144M810220	Additional set-up cost Select Color/ color	353
144M710510	Seams in contrasting Colors, Easy Chair	178
144M710610	Seams in contrasting Colors, 2-seater sofa	251

**Seat and back**

Support fabric of black or natural linen with matching leather details.  
Seat and back cushion in matching linen or leather with high resilient polyurethane foam.

**Frame**

Ø22 mm powder coated or chromed steel tubing. Glides.



**When ordering, specify:**

Colour support fabric and pad

Colour leather pad

Colour powder coat

\*Additional set-up cost applies for powder coat in our Select Color range, see options.

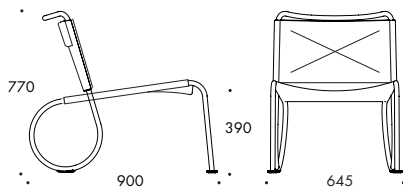

**CORSO EASY CHAIR, CANVAS**

Weight (kg) 9.5      Freight volume (m³) 0.67

Art.no.	Description	Cat. B
126E140120	Support fabric and upholstery in linen, Powder coated* frame	22 2265
126E140140	Support fabric and upholstery in linen, Chromed frame	2739

**CORSO EASY CHAIR, LEATHER**

Weight (kg) 9.5      Freight volume (m³) 0.67

Art.no.	Description	Cat. B
126E140120	Support fabric in linen and upholstery in Elmo Nordic leather, Powder coated* frame	22 2265
126E140140	Support fabric in linen and upholstery in Elmo Nordic leather, Chromed frame	2739

**ADDITIONAL OPTIONS CORSO**

Art.no.	Description	Price
144M810220	Additional set-up cost Select Color/ color	10 353





**Seat and back**

Seat frame of massive wood and moulded high resilient polyurethane foam.  
 Back of moulded wood and high resilient polyurethane foam incl. quilting on the outside.  
 Note! Leather, imitation leather or patterned fabrics are not available.  
 Seat and cushion in these materials on request.

**Cushions**

Back cushion of high resilient polyurethane foam by default alt. 1 or 2 decoration pillows with down filling. When upholstered in 2 colours the back cushion follows the colour of the seat.

**Frame**

Legs of powder coated or chromium plated Ø35 mm steel tubing alt. natural ash. Stained legs at an additional cost. Glides.

**When ordering, specify:**

Fabric and colour

Colour powder coat

\*Additional set-up cost applies for powder coat in our Select Color range, see options.

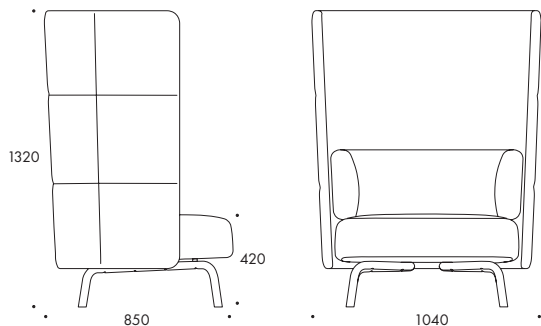

**PORTUS EASY CHAIR, HIGH BACK**

Weight (kg) 50.0      Freight volume (m³) 1.20      Fabric required 6500x1400 mm

Art.no.	Description	Cat. A	Cat. B	Cat. C	Cat. D	Cat. E
		21	22	23	24	25
127E140420	High Back, Powder coated* legs	3546	4229	4444	4572	4916
127E140440	High Back, Chromed legs	3649	4352	4571	4704	5058
127E140450	High Back, Wooden legs in ash	3663	4343	4513	4683	5022

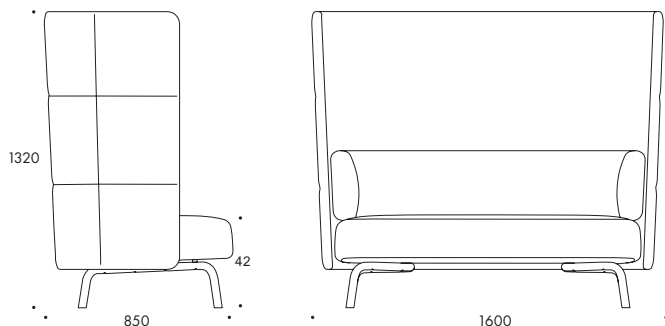

**PORTUS SOFA, 2-SEATER, HIGH BACK**

Weight (kg) 72.0      Freight volume (m³) 1.80      Fabric required 8600x1400 mm

Art.no.	Description	Cat. A	Cat. B	Cat. C	Cat. D	Cat. E
		21	22	23	24	25
127G240420	High Back, Powder coated* legs	4581	5524	5762	5996	6468
127G240440	High Back, Chromed legs	4726	5699	5944	6186	6672
127G240450	High Back, Wooden legs in ash	4870	5844	6088	6331	6818

**ADDITIONAL OPTIONS PORTUS**

Art.no.	Description	Price 10
144M810220	Additional set-up cost Select Color/ color	353
144M710110	Two-Colored upholstery, Note, the back cushion follows the Color of the seat	139
144M810250	Stain standard Color	58
127M710210	Decorative cushion in down for Easy Chair, 1 cushion	44
127M710310	Decorative cushion in down for 2-seater sofa, 2 cushions	83
127M710410	Decorative cushion in down for 3-seater sofa, 3 cushions	124

## S70-4 & S70-5

Design Börge Lindau & Bo Lindekrantz 1968



### Seat and back

Cushions with cold foam padding

### Frame

Ø35 mm powder coated or chromed steel tubing. Glides.

When ordering, specify:

Fabric and colour

Colour powder coat

\*Additional set-up cost applies for powder coat in our Select Color range, see options.

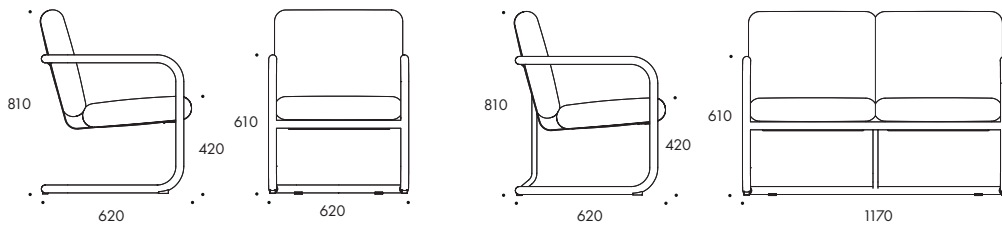

### S70-4 EASY CHAIR

Weight (kg) 13.1      Freight volume (m<sup>3</sup>) 0.40      Fabric required 1600x1400 mm

Art.no.	Description	Cat. A 21	Cat. B 22	Cat. C 23	Cat. D 24	Cat. E 25	Cat. F 26
119E640120	Fully upholstered, Powder coated* frame	1111	1396	1468	1540	1684	1986
119E640140	Fully upholstered, Chromed frame	1335	1676	1762	1848	2022	2384

### S70-5 SOFA

Weight (kg) 22.9      Freight volume (m<sup>3</sup>) 0.60      Fabric required 3200x1400 mm

Art.no.	Description	Cat. A 21	Cat. B 22	Cat. C 23	Cat. D 24	Cat. E 25	Cat. F 26
119G640120	Fully upholstered, Powder coated* frame	2208	2414	2553	2693	2973	3617
119G640140	Fully upholstered, Chromed frame	2208	2896	3064	3233	3568	4340

### ADDITIONAL OPTIONS S70-4/S70-5

Art.no.	Description	Price 10
144M810220	Additional set-up cost Select Color/ color	353

**Seat and back**

Wooden fibre board with cold foam padding.

Note! The high corner module can not be used independently.

**Frame**

Sledbase in powder coated or chromed Ø22 mm steel tubing. Glides.

High modules incl. adjustable glides.

**Linking device**

Built-in magnets in each module.

Area and Area Radius can be used and linked together.

**Note**

Right/Left unit described as when sitting in the sofa.

When ordering, specify:

Fabric and colour

Colour powder coat

\*Additional set-up cost applies for powder coat in our Select Color range, see options.

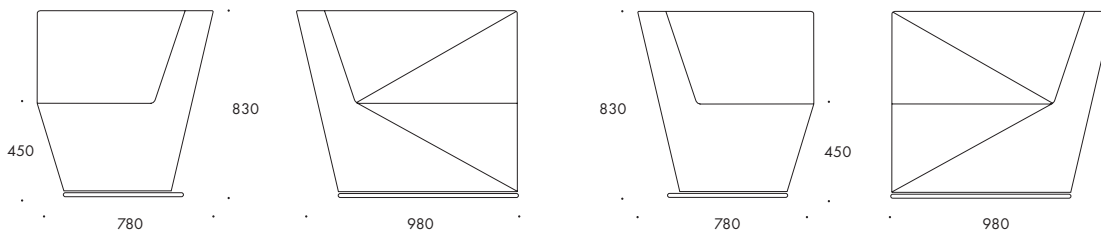

**AREA RIGHT SECTION LOW BACK**

Weight (kg) 27.5      Freight volume (m³) 0.70      Fabric required 2900x1400 mm

Art.no.	Description	Cat. A	Cat. B	Cat. C	Cat. D	Cat. E	Cat. F
		21	22	23	24	25	26
1301240220	Right Section low back, Fully upholstered, Powder coated* frame	1934	2357	2463	2568	2780	4007
1301240240	Right Section low back, Fully upholstered, Chromed frame	1934	2357	2463	2568	2780	4007
1301340220	Left section low back, Fully upholstered, Powder coated* frame	1934	2357	2463	2568	2780	4007
1301340240	Left section low back, Fully upholstered, Chromed frame	1934	2357	2463	2568	2780	4007

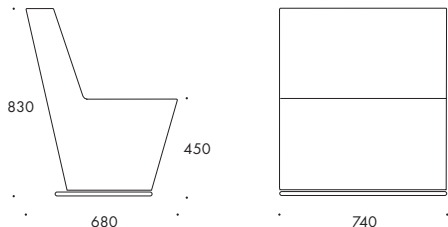

**AREA CENTRE SECTION LOW BACK**

Weight (kg) 18.6      Freight volume (m³) 0.53      Fabric required 2300x1400 mm

Art.no.	Description	Cat. A	Cat. B	Cat. C	Cat. D	Cat. E	Cat. F
		21	22	23	24	25	26
1301440220	Centre section low back, Fully upholstered, Powder coated* frame	1575	1841	1908	1973	2107	2845
1301440240	Centre section low back, Fully upholstered, Chromed frame	1575	1841	1908	1973	2107	2845

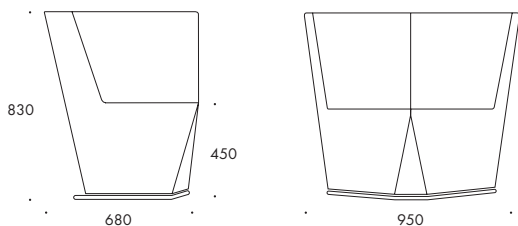

**AREA CORNER SECTION LOW BACK**

Weight (kg) 21.4      Freight volume (m³) 0.53      Fabric required 2400x1400 mm

Art.no.	Description	Cat. A	Cat. B	Cat. C	Cat. D	Cat. E	Cat. F
		21	22	23	24	25	26
1301540220	Corner section low back, Fully upholstered, Powder coated* frame	1993	2294	2370	2444	2591	3366
1301540240	Corner section low back, Fully upholstered, Chromed frame	1993	2294	2370	2444	2591	3366

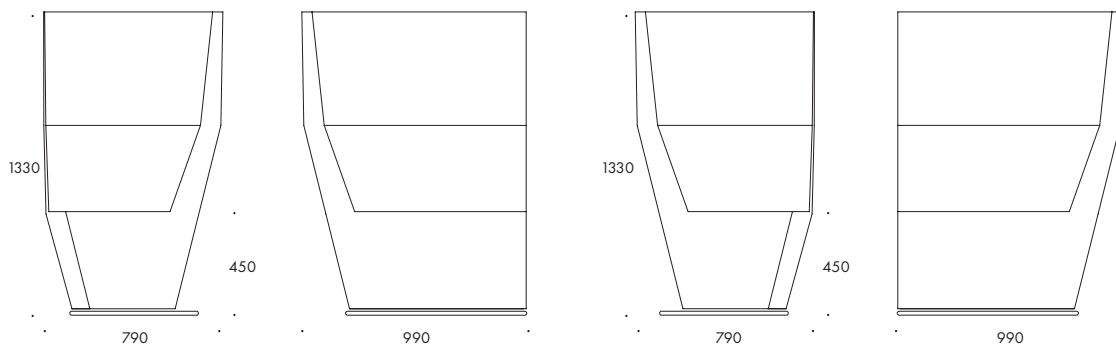

### AREA RIGHT SECTION HIGH BACK

Weight (kg) 43.5      Freight volume (m<sup>3</sup>) 1.20      Fabric required 4300x1500 mm

Art.no.	Description	Cat. A	Cat. B	Cat. C	Cat. D	Cat. E	Cat. F
		21	22	23	24	25	26
1301240420	Right Section high back, Fully upholstered, Powder coated* frame	3424	4117	4294	4470	4817	6604
1301240440	Right Section high back, Fully upholstered, Chromed frame	3424	4117	4294	4470	4817	6604
1301340420	Left section high back, Fully upholstered, Powder coated* frame	3424	4117	4294	4470	4817	6604
1301340440	Left section high back, Fully upholstered, Chromed frame	3424	4117	4294	4470	4817	6604

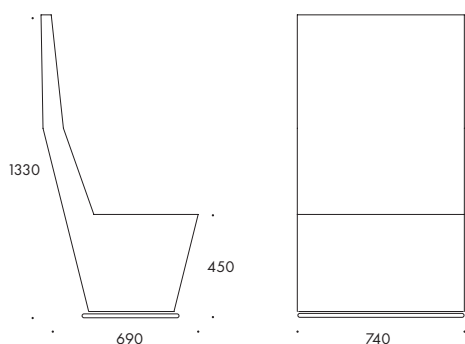

### AREA CENTRE SECTION HIGH BACK

Weight (kg) 29.0      Freight volume (m<sup>3</sup>) 1.03      Fabric required 3000x1500 mm

Art.no.	Description	Cat. A	Cat. B	Cat. C	Cat. D	Cat. E	Cat. F
		21	22	23	24	25	26
1301440420	Centre section high back, Fully upholstered, Powder coated* frame	2834	3271	3383	3489	3706	5069
1301440440	Centre section high back, Fully upholstered, Chromed frame	2834	3271	3383	3489	3706	5069

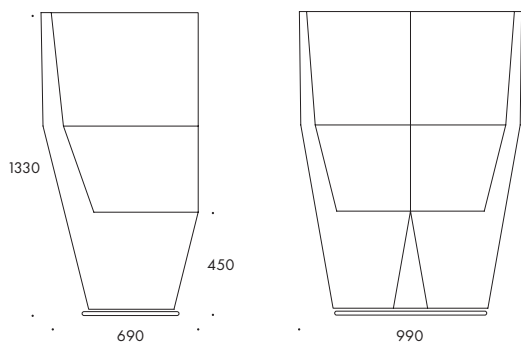

### AREA CORNER SECTION HIGH BACK

Weight (kg) 35.0      Freight volume (m<sup>3</sup>) 1.03      Fabric required 3500x1500 mm

Art.no.	Description	Cat. A	Cat. B	Cat. C	Cat. D	Cat. E	Cat. F
		21	22	23	24	25	26
1301540420	Corner section high back, Fully upholstered, Powder coated* frame	3520	4018	4141	4288	4504	5867
1301540440	Corner section high back, Fully upholstered, Chromed frame	3520	4018	4141	4288	4504	5867

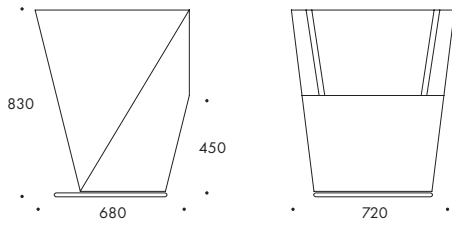

### AREA EASY CHAIR

Weight (kg) 25. Freight volume (m<sup>3</sup>) 0.53 Fabric required 2600x1500 mm

Art.no.	Description	Cat. A	Cat. B	Cat. C	Cat. D	Cat. E	Cat. F
130E240220	Fully upholstered, Powder coated* frame	1518	1904	1999	2097	2291	3954
130E240240	Fully upholstered, Chromed frame	1518	1904	1999	2097	2291	3954

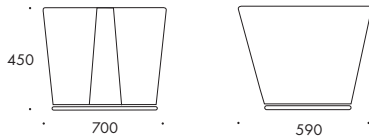

### AREA STOOL

Weight (kg) 10.0 Freight volume (m<sup>3</sup>) 0.25 Fabric required 1300x1500 mm

Art.no.	Description	Cat. A	Cat. B	Cat. C	Cat. D	Cat. E	Cat. F
130F330120	Fully upholstered, Powder coated* frame	21	22	23	24	25	26
130F330140	Fully upholstered, Chromed frame	1285	1490	1544	1597	1699	2082

### ADDITIONAL OPTIONS AREA

Art.no.	Description	Price
144M810220	Additional set-up cost Select Color/ color	10
144M710110	Area 2-Colored upholstery	353
		139

# AREA RADIUS

Design Anya Sebton 2016



## Seat and back

Wooden fibre board withold foam padding.

## Frame

Sledbase in powder coated or chromed Ø22 mm steel tubing. Glides.

High modules incl. adjustable glides.

## Linking device

Built-in magnets in each module.

Area and Area Radius can be used and linked together.



## When ordering, specify:

Fabric and colour

Colour powder coat

\* Additional set-up cost applies for powder coat in our Select Color range, see options.

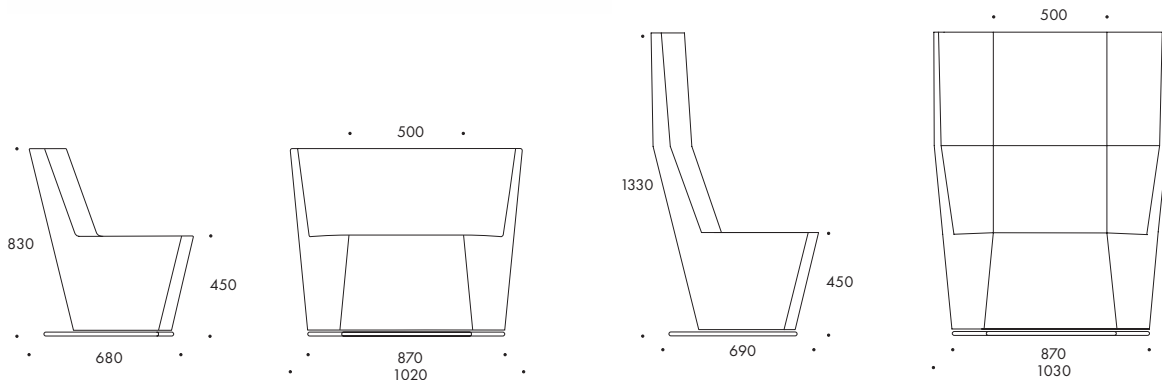

## AREA RADIUS 45°

Weight (kg) 15.2      Freight volume (m³) 0.70      Fabric required 2500x1400 mm

Art.no.	Description	Cat. A	Cat. B	Cat. C	Cat. D	Cat. E	Cat. F
		21	22	23	24	25	26
1281640220	Section 45° low back, Fully upholstered, Powder coated* frame	1878	2288	2392	2494	2699	3891
1281640240	Section 45° low back, Fully upholstered, Chromed frame	1991	2427	2536	2644	2854	4046
1281640420	Section 45° high back, Fully upholstered, Powder coated* frame	3324	3998	4168	4338	4676	6004
1281640440	Section 45° high back, Fully upholstered, Chromed frame	3523	4199	4369	4542	4896	6227

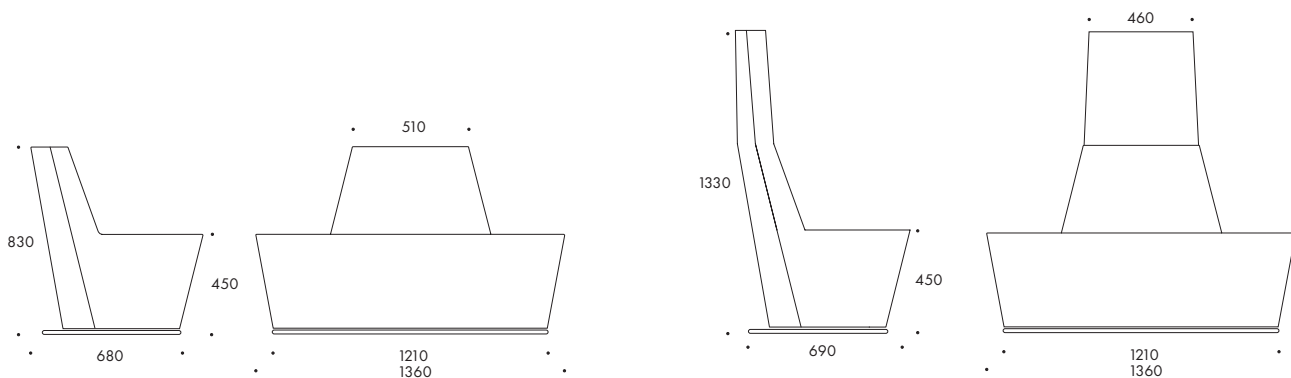

## AREA RADIUS 90°

Weight (kg) 13.9      Freight volume (m³) 1.00      Fabric required 2800x1400 mm

Art.no.	Description	Cat. A	Cat. B	Cat. C	Cat. D	Cat. E	Cat. F
		21	22	23	24	25	26
1281740220	Section 90° low back, Fully upholstered, Powder coated* frame	1878	2288	2392	2494	2699	3891
1281740240	Section 90° low back, Fully upholstered, Chromed frame	1991	2403	2508	2612	2817	4007
1281740420	Section 90° high back, Fully upholstered, Powder coated* frame	3324	3998	4168	4338	4676	6215
1281740440	Section 90° high back, Fully upholstered, Chromed frame	3523	4199	4369	4542	4880	6421

## ADDITIONAL OPTIONS AREA RADIUS

Art.no.	Description	Price
144M810220	Additional set-up cost Select Color/ color	10
144M710110	Area Radius 2-Colored upholstery	353
		139

**Seat & back**

Shell of fibre board with high resilient polyurethane foam. Adjustable glides. Base of black lacquered mdf for an additional cost.

**Linking**

All modules can be used as solitaires or be linked with an additional linking device.

**Table**

Linkable table top, 30x49cm, of 3mm texture powder coated sheet metal.

When ordering, specify:

Fabric and colour

\*Additional set-up cost applies for powder coat in our Select Color range, see options.

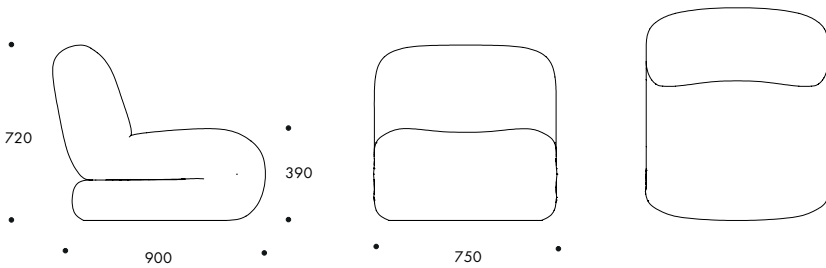

**BAU EASY CHAIR STRAIGHT**

Weight (kg) 19.5      Freight volume (m<sup>3</sup>) 0.55      Fabric required 2400x1400 mm

Art.no.	Description	Cat. A	Cat. B	Cat. C	Cat. D	Cat. E	Cat. F
133E240210	Straight, Fully upholstered	21	22	23	24	25	26
		1346	1591	1706	1744	1899	2662

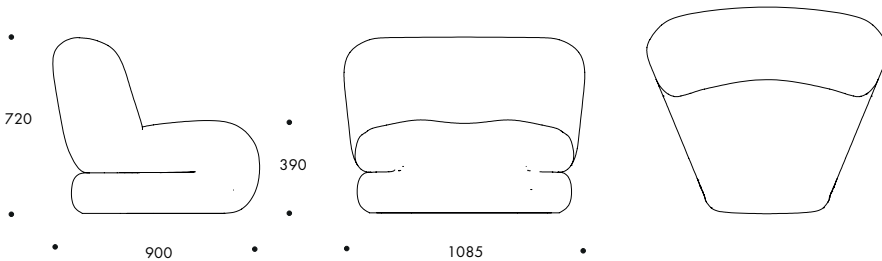

**BAU EASY CHAIR 45° CLOSED**

Weight (kg) 25      Freight volume (m<sup>3</sup>) 0.70      Fabric required 2700x1400 mm

Art.no.	Description	Cat. A	Cat. B	Cat. C	Cat. D	Cat. E	Cat. F
133E340210	45° closed, Fully upholstered	21	22	23	24	25	26
		1613	1894	2023	2067	2240	3087

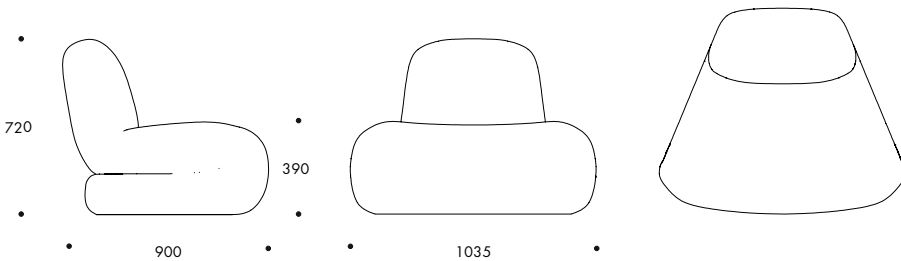

**BAU EASY CHAIR 45° OPEN**

Weight (kg) 21      Freight volume (m<sup>3</sup>) 0.70      Fabric required 2400x1400 mm

Art.no.	Description	Cat. A	Cat. B	Cat. C	Cat. D	Cat. E	Cat. F
133E440210	45° open, Fully upholstered	21	22	23	24	25	26
		1518	1769	1885	1921	2077	2854

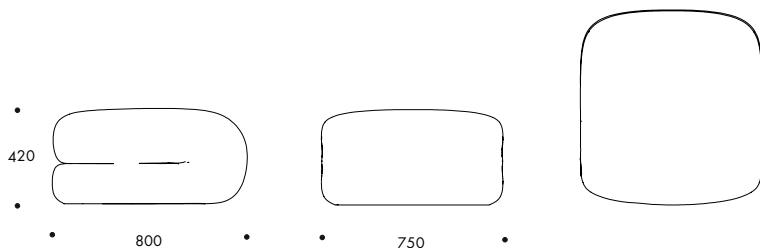

### BAU POUF STRAIGHT

Weight (kg) 15.5      Freight volume (m<sup>3</sup>) 0.30      Fabric required 2100x1400 mm

Art.no.	Description	Cat. A	Cat. B	Cat. C	Cat. D	Cat. E	Cat. F
133F240210	Straight, Fully upholstered	21	22	23	24	25	26
		1134	1343	1447	1479	1613	2260

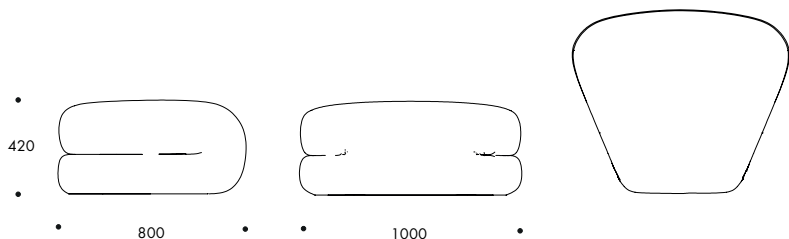

### BAU POUF 45° CLOSED

Weight (kg) 16.5      Freight volume (m<sup>3</sup>) 0.45      Fabric required 2150x1400 mm

Art.no.	Description	Cat. A	Cat. B	Cat. C	Cat. D	Cat. E	Cat. F
133F340210	45° closed, Fully upholstered	21	22	23	24	25	26
		1242	1464	1568	1601	1738	2410

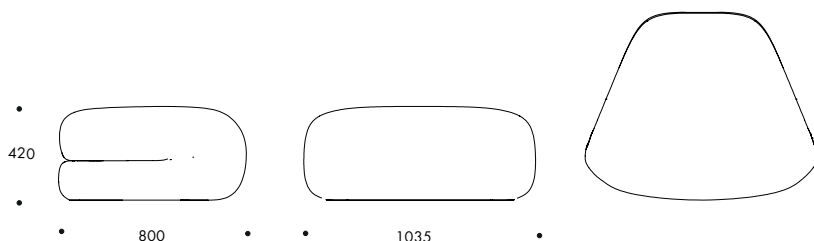

### BAU POUF 45° OPEN

Weight (kg) 16.5      Freight volume (m<sup>3</sup>) 0.45      Fabric required 2150x1400 mm

Art.no.	Description	Cat. A	Cat. B	Cat. C	Cat. D	Cat. E	Cat. F
133F440210	45° open, Fully upholstered	21	22	23	24	25	26
		1357	1584	1686	1719	1858	2529

### LINKING TABLE

Art.no.	Description	Price
133J1A1120	Linking table 300x490 mm, texture powder coat*	90
		213

### ADDITIONAL OPTIONS BAU

Art.no.	Description	Price
133M610110	Linking device, price per pair	10
133M710117	Base, black, additional price per unit	140
		192



**Seat & back** Shell of fibre board with high resilient polyurethane foam. Seat with Nozag spring. Removable upholstery. Power supply and USB outlets at additional cost.

**Legs**

Adjustable glides. Powder coated or chromed protective metal caps for legs as at an additional cost.

**Linking**

All modules can be used as solitaires or be linked. Linking device included in all units.

**Note**

Right/Left unit described as when sitting in the unit.



When ordering, specify:

Fabric and colour

Colour powder coat

\*Additional set-up cost applies for powder coat in our Select Color range, see options.

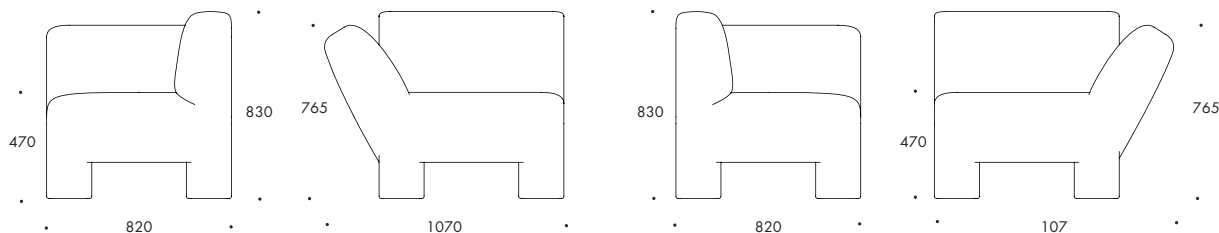

**GEOFANTI RIGHT MODULE**

Weight (kg) 42.0      Freight volume (m³) 1.19      Fabric required 4700x1400 mm

Art.no.	Description	Cat. A 21	Cat. B 22	Cat. C 23	Cat. D 24	Cat. E 25	Cat. F 26
150E240210	Right section, Fully upholstered	1689	2026	2442	2493	2702	3724
150E340210	Left section, Fully upholstered	1689	2026	2442	2493	2702	3724

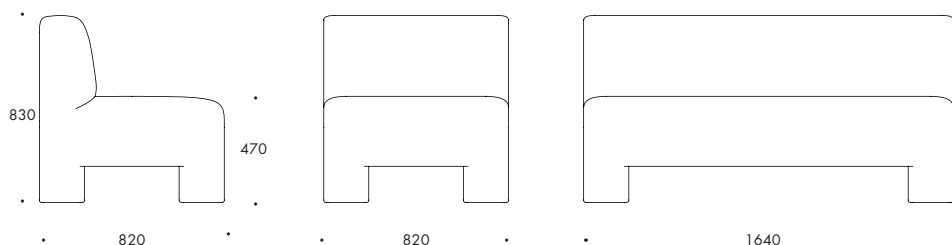

**GEOFANTI 1-SEATER WITH BACK**

Weight (kg) 28.0      Freight volume (m³) 0.61      Fabric required 3700x1400 mm

Art.no.	Description	Cat. A 21	Cat. B 22	Cat. C 23	Cat. D 24	Cat. E 25	Cat. F 26
150E440210	1-seater with back, Fully upholstered	1429	1715	2068	2110	2286	3151

**GEOFANTI 2-SEATER WITH BACK**

Weight (kg) 42.0      Freight volume (m³) 1.19      Fabric required 5800x1400 mm

Art.no.	Description	Cat. A 21	Cat. B 22	Cat. C 23	Cat. D 24	Cat. E 25	Cat. F 26
150G440210	2-seater with back, Fully upholstered	2078	2494	3005	3069	3325	4582

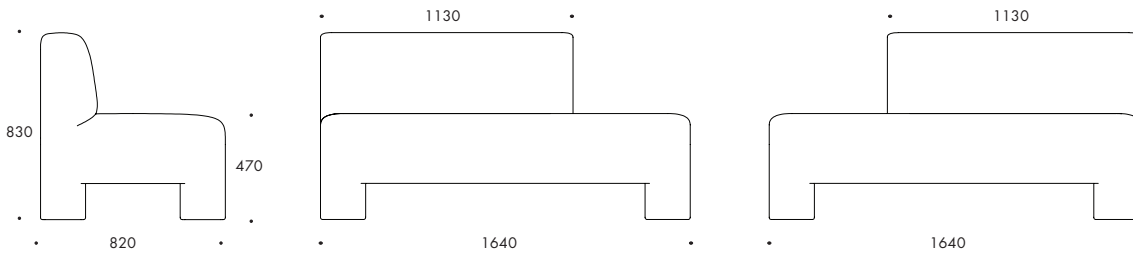

#### GEOFANTI 2-SEATER WITH SHORT BACK RIGHT

Weight (kg) 40.0      Freight volume (m<sup>3</sup>) 1.19      Fabric required 4400x1400 mm

Art.no.	Description	Cat. A	Cat. B	Cat. C	Cat. D	Cat. E	Cat. F
150G240210	2-seater with short back, right, Fully upholstered	21	22	23	24	25	26
		1948	2338	2817	2876	3117	4297

#### GEOFANTI 2-SEATER WITH SHORT BACK LEFT

Weight (kg) 40.0      Freight volume (m<sup>3</sup>) 1.19      Fabric required 4400x1400 mm

Art.no.	Description	Cat. A	Cat. B	Cat. C	Cat. D	Cat. E	Cat. F
150G340210	2-seater with short back, left, Fully upholstered	21	22	23	24	25	26
		1948	2338	2817	2876	3117	4297

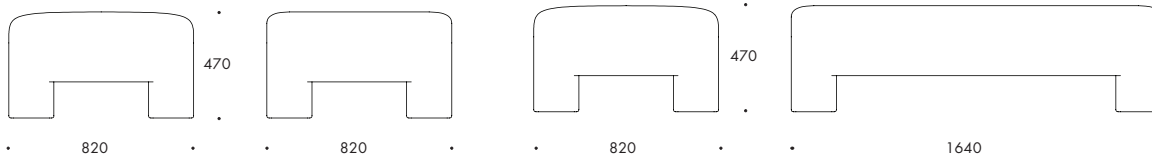

#### GEOFANTI 1-SEATER WITHOUT BACK

Weight (kg) 22.0      Freight volume (m<sup>3</sup>) 0.36      Fabric required 2700x1400 mm

Art.no.	Description	Cat. A	Cat. B	Cat. C	Cat. D	Cat. E	Cat. F
150F440510	1-seater without back, Fully upholstered	21	22	23	24	25	26
		1169	1403	1691	1727	1871	2579

#### GEOFANTI 2-SEATER WITHOUT BACK

Weight (kg) 33.0      Freight volume (m<sup>3</sup>) 0.7      Fabric required 4100x1400 mm

Art.no.	Description	Cat. A	Cat. B	Cat. C	Cat. D	Cat. E	Cat. F
150H440510	2-seater without back, Fully upholstered	21	22	23	24	25	26
		1689	2026	2442	2493	2702	3724

#### ADDITIONAL OPTIONS GEOFANTI

Art.no.	Description	Price
150M710140	Chromed protective metal caps for legs	325
150M710120	Powder coated protective metal caps for legs	260
132O210217	Power supply, 2 USB A/C + 1 electrical Schuko standard, cable length 1.25m	213
132O210317	Power supply, 2 + 2 USB A/C Schuko standard, cable length 1.25m	271
132O210417	Power supply, 1 + 1 electrical Schuko standard, cord length 1.25m	155
144M810220	Additional set-up cost Select Color/ color	353

**Seat and back**

Support fabric in black or natural linen. Cushions with 25% RDS-certified seabird feather and 75% grated cold foam.

**Frame**

Frame in Ø20mm powder coated or chrome-plated steel tube. Feet in die-cast zinc. Teflon glides.

Frames as single pieces, with or without arms and as a connection module.

Castor at an additional cost on easy chair with or without armrests in the colours black, white, graphite or polished.

**Linking devices**

The frames can be linked by linking feet or by linking tables.

**Tables**

Connecting table tops in black Perfect Sense melamine or white laminate in 2 sizes.

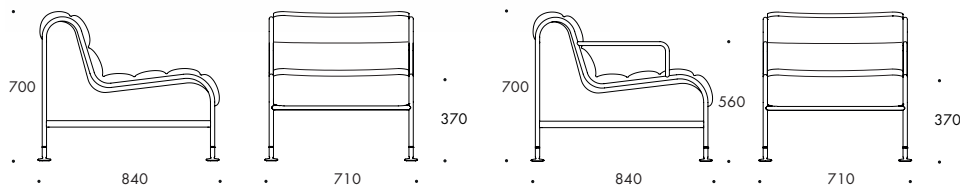

**When ordering, specify:**

Colour support fabric

Fabric and colour

Colour powder coat

†

\*Additional set-up cost applies for powder coat in our Select Color range, see options.

**SUNNY EASY CHAIR**

Weight (kg) 14.0      Freight volume (m³) 0.67      Fabric required 1600x1400 mm

Art.no.	Description	Cat. A	Cat. B	Cat. C	Cat. D	Cat. E	Cat. F
		21	22	23	24	25	26
131E240120	Fully upholstered, Support fabric in linen, Powder coated* frame	2416	2623	2729	2808	2915	3364
131E240140	Fully upholstered, Support fabric in linen, Chromed frame	2594	2925	3043	3133	3252	3751

**SUNNY EASY CHAIR WITH ARMRESTS**

Weight (kg) 14.7      Freight volume (m³) 0.67      Fabric required 1600x1400 mm

Art.no.	Description	Cat. A	Cat. B	Cat. C	Cat. D	Cat. E	Cat. F
		21	22	23	24	25	26
131E340120	Fully upholstered, Support fabric in linen, Powder coated* frame	2532	2837	2946	3031	3142	3474
131E340140	Fully upholstered, Support fabric in linen, Chromed frame	2719	3048	3164	3255	3375	3742

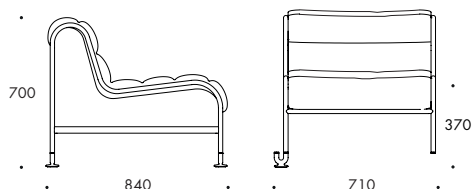

**SUNNY LINKING MODULE**

Weight (kg) 14.0      Freight volume (m³) 0.67      Fabric required 1600x1400 mm

Art.no.	Description	Cat. A	Cat. B	Cat. C	Cat. D	Cat. E	Cat. F
		21	22	23	24	25	26
131I240320	Fully upholstered, Support fabric in linen, Powder coated* frame	2408	2713	2822	2907	3019	3483
131I240340	Fully upholstered, Support fabric in linen, Chromed frame	2586	2914	3031	3122	3244	3742

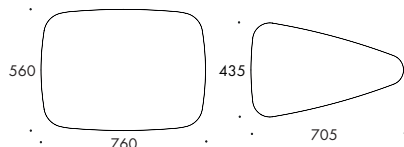

**SUNNY LINKING TABLE**

Weight (kg) 4.1      Freight volume (m³) 0.02

Art.no.	Description	Price	HPL
			50
131J1A1220	Linking table 30°	479	410
131J1A2220	Linking table 760x560	479	410

**ADDITIONAL OPTIONS SUNNY**

Art.no.	Description	Price
144M810220	Additional set-up cost Select Color/ color	353
144M210210	Replacement from glides to white casters	60

**Seat and back**

Seat in plywood and cut cold foam.

**Frame**

Pillar in texture powder coated steel tubing, Ø40 mm, with die cast foot in powder coated aluminium. Profiles in black extruded aluminium.

Starter module includes 2 feet and linking module 1 foot. Adjustable feet.

Adjustable seat height, 460 or 500mm.

Polished aluminium foot and pillar for seat height 630 mm at an additional costs.

Armrests, floor- and wall fastening devices, linking devices and power supplies at additional costs.

**Tables**

Connecting table, white or black 12 mm compact laminate. Various sizes.

When ordering, specify:

Fabric and colour

Colour powder coat

\*Additional set-up cost applies for powder coat in our Select Color range, see options.

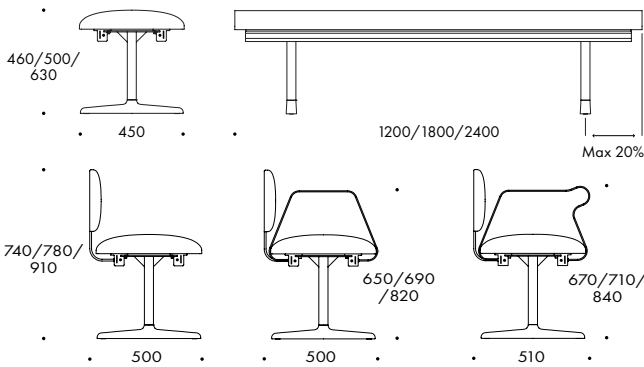

**TEIUS BENCH, START MODULE**

Required fabric L1200=1000x1400 mm / L1800=1000x1400 mm / L2400=1300x1400 mm

Art.no.	Description	Cat. A	Cat. B	Cat. C	Cat. D	Cat. E	Cat. F	m <sup>3</sup>
		21	22	23	24	25	26	
132H130220	Starter module L1200, Powder coated* legs	1035	1166	1239	1263	1296	1421	0.18
132H130320	Starter module L1800, Powder coated* legs	1317	1448	1521	1545	1574	1904	0.24
132H130420	Starter module L2400, Powder coated* legs	1562	1735	1829	1860	1899	2153	0.30

**TEIUS BENCH, CONNECTION MODULE**

Required fabric L1200=1000x1400 mm / L1800=1000x1400 mm / L2400=1300x1400 mm

Art.no.	Description	Cat. A	Cat. B	Cat. C	Cat. D	Cat. E	Cat. F	m <sup>3</sup>
		21	22	23	24	25	26	
132I130220	Connection module L1200, Powder coated* legs	915	1044	1116	1140	1169	1289	0.18
132I130320	Connection module L1800, Powder coated* legs	1196	1327	1402	1423	1454	1783	0.24
132I130420	Connection module L2400, Powder coated* legs	1443	1616	1709	1740	1780	2031	0.30

**TEIUS BACK**

Required fabric L1200=950x1400 mm / L1800=1300x1400 mm / L2400=1600x1400 mm

Art.no.	Description	Cat. A	Cat. B	Cat. C	Cat. D	Cat. E	Cat. F	m <sup>3</sup>
		21	22	23	24	25	26	
132M740220	Back Module L1200, Powder coated* bracket	324	442	494	527	564	638	0.06
132M740320	Back Module L1800, Powder coated* bracket	411	571	664	692	729	1012	0.09
132M740420	Back Module L2400, Powder coated* bracket	505	701	809	845	887	1107	0.12

**TEIUS CONNECTING TABLE**

Art.no.	Description	Compact laminate 60
132J2A1220	Connecting table, 12 mm compact laminate, 450x450 mm	392
132J2A2220	Connecting table, 12 mm compact laminate, 60°	541
132J2A3220	Connecting table, 12 mm compact laminate, 90°	592

## ADDITIONAL OPTIONS TEIUS

Art.no.	Description	Price 10
144M810220	Additional set-up cost Select Color/ color	353
132M210160	Polished aluminium foot, price per foot	45
132M410220	Armrests, Powder coated*, price per armrest	136
132M410320	Armrest with rise support, Powder coated* legs, price per armrest	183
132M210120	Leg pillar for seat height 630 mm, Powder coated*, price per piece	104
132M610220	Floor fastening, Galvanized, price per fastener	48
132M610320	Wall brackets, Powder coated*, price per piece	86
132M610420	Connection back - back, Powder coated*, price per pair	77
144M810350	Standard stain, smaller table	116
132O210217	Power supply, 2 USB A/C + 1 electrical Schuko standard, cable length 1.25m	213
132O210317	Power supply, 2 + 2 USB A/C Schuko standard, cable length 1.25m	271
132O210417	Power supply, 1 + 1 electrical Schuko standard, cord length 1.25m	155

## ADD

Design Anya Seblon 2013



### Table top

Table top in 3 mm texture powder coated sheet steel.

### Frame

Pillar in Ø25mm steel tubing. Footplate in texture powder coat. Chrome plated sheet steel at an additional cost. Felt glides.

\* Additional set-up cost, see options.

When ordering, specify:

Colour powder coat

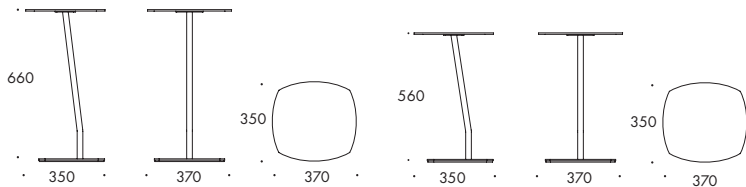

## ADD TABLE, H660

Art.no.	Description	Price		
		10	kg	m <sup>3</sup>
101J3A1220	Powder coated* H660	546	7.5	0.14

## ADD TABLE, H560

Art.no.	Description	Price		
		10	kg	m <sup>3</sup>
101J2A1220	Powder coated*, H560	546	7.4	0.11

## ADDITIONAL OPTIONS ADD TABLE

Art.no.	Description	Price 10
144M810220	Additional set-up cost Select Color/ color	353
101M310140	Chromed footplate & pillar base	100
144M410110	Detachable top surface in cork	179

## ADD CABLE TABLE

Design Anya Sebtou 2018



### Table top

Table top in 3 mm texture powder coated sheet steel.

### Frame

Pillar in Ø25mm steel tubing. Pressure-lathed foot in steel, texture powder coat. Felt glides.

### Power

5 m retractable cable reel and anthracite-coloured power outlets.

2 electrical outlets. Outlets are available for the most common standards

1 electrical outlet, 1 USB A & 1 UCB C at an additional cost.

\*Additional set-up cost, see options.

### When ordering, specify:

Colour powder coat

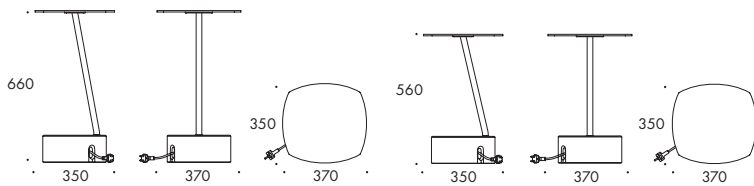

### ADD CABLE TABLE, H660

Art.no.	Description	Price		
		10	kg	m <sup>3</sup>
101J3A1320	Powder coated*, Incl 2 electrical outlets, H660	1207	12.9	0.14

### ADD CABLE TABLE, H560

Art.no.	Description	Price		
		10	kg	m <sup>3</sup>
101J2A1320	Powder coated*, Incl 2 electrical outlets, H560 mm	1207	12.8	0.11

### ADDITIONAL OPTIONS ADD CABLE TABLE

Art.no.	Description	Price
		10
144M810220	Additional set-up cost Select Color/ color	353
144M410110	Detachable top surface in cork	179
101M510210	Alternatively power socket with 1 electrical + 1 USB A/C	191

# ARCHAL T

Design Johannes Foersom & Peter HiortLorenzen 2014



### Table top

Wood fibreboard in 19 mm white-grey melamine with matching edge. The veneer direction follows the long side of the table.

### Frame

Texture powder coated or chrome-plated frame with 40x40 mm steel tubing pillar.

Foot texture powder coated or polished die cast aluminium. Graphite or white adjustable glides.

Standard table height 730 mm. 900 and 1100 mm at an additional cost.

### Linked tables

Tables can be connected with a removable linking device or with a permanent linking solution.

The permanent version includes a leg which connects the table tops. See drawing below.

Deduct EUR 125 from the price of two free standing tables when this linking solution is used.

### Options

Other shapes, sizes and finishes on request.

\* Additional set-up cost, see options.

When ordering, specify:

Colour powder coat

Height

Colour glides

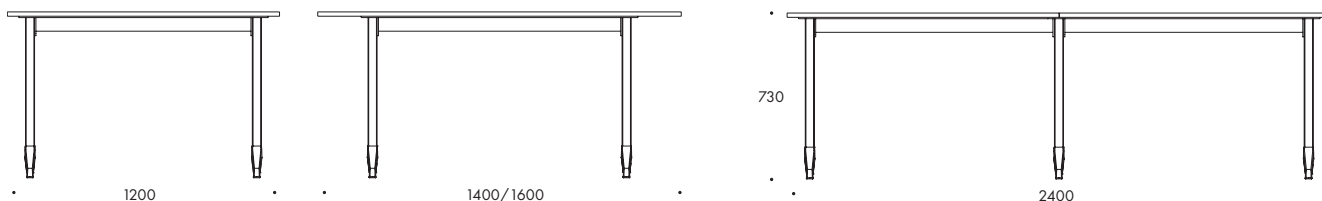
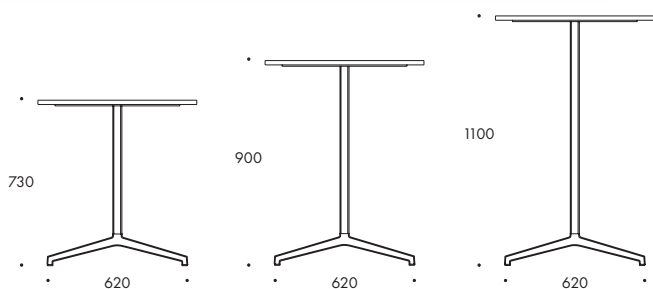

## ARCHAL T TABLE, H730

Art.no.	Description	Melamine		
		30	kg	m <sup>3</sup>
104J1T1120	Tabletop 1200x600, Powder coated* frame	1074	18.0	0.28
104J1T2120	Tabletop 1400x700, Powder coated* frame	1115	23.0	0.32
104J1T3120	Tabletop 1600x800, Powder coated* frame	1240	32.0	0.36
104J1T4120	Tabletop 1800x800, Powder coated* frame	1289	34.0	0.38
104J1T1160	Tabletop 1200x600, Frame in polished aluminium	1219	18.0	0.28
104J1T2160	Tabletop 1400x700, Frame in polished aluminium	1259	23.0	0.32
104J1T3160	Tabletop 1600x800, Frame in polished aluminium	1383	32.0	0.36
104J1T4160	Tabletop 1800x800, Frame in polished aluminium	1431	34.0	0.38

## ADDITIONAL OPTIONS ARCHAL T

Art.no.	Description	Price
144M810220	Additional set-up cost Select Color/ color	353
104M210710	Height 900	83
104M210810	Height 1100	146
144M610610	Linking device complete (quick connect)	69

# ARCHAL X

Design Johannes Foersom & Peter HiortLorenzen 2014



### Table top

Wood fibreboard in 19 mm white-grey melamine with matching edge.

### Frame

Texture powder coated or chrome-plated frame with 40x40 mm steel tubing pillar.

Foot texture powder coated or polished die cast aluminium. Graphite or white adjustable glides.

Standard table height 620 or 730 mm. 900 and 1100 mm at an additional cost.

### Options

Other shapes, sizes and finishes on request.

\* Additional set-up cost, see options.

### When ordering, specify:

Colour powder coat

Height

Colour glides

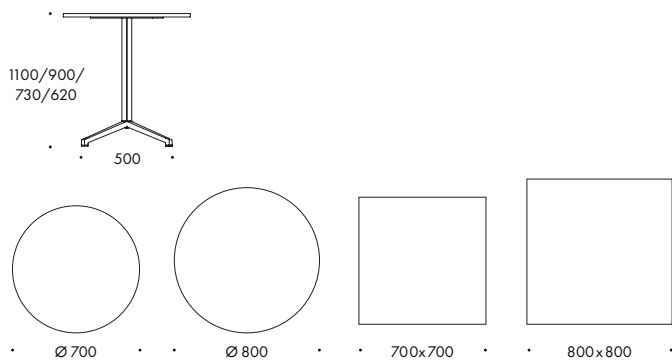

## ARCHAL X TABLE

Art.no.	Description	Melamine		
		30	kg	m <sup>3</sup>
104J1X1120	Table top Ø700, Powder coated* frame	732	16.9	0.31
104J1X2120	Table top 700x700, Powder coated* frame	732	16.1	0.31
104J1X3120	Table top Ø 800, Powder coated* frame	745	18.0	0.45
104J1X1160	Table top Ø 700, Frame in polished aluminium	821	16.9	0.31
104J1X2160	Table top 700x700, Frame in polished aluminium	821	16.1	0.31
104J1X3160	Table top Ø 800, Frame in polished aluminium	832	18.0	0.45

## ADDITIONAL OPTIONS ARCHAL X

Art.no.	Description	Price
144M810220	Additional set-up cost Select Color/ color	10
104M210510	Height 900	353
104M210610	Height 1100	57
		89



**Table top**

22 mm wood fibreboard in the following versions:

Veneer: natural ash or oak with matching wooden edge. Stained table top at an additional cost. The veneer direction follows the long side of the table. On linked tops, the veneer is matched. When ordering the Integrated power port in veneer top, the hatches are made from a separate sheet of veneer, this may result in some difference in the grain from the table top. Linoleum: Forbo Furniture with matching plastic edge when possible.

Note! For some colors matching edge isn't available, divergent edge is offered according to agreement.

High Pressure Laminate: white with matching plastic edge.

Melamine: white with matching plastic edge.

Melamine Perfect Sense matt anti-fingerprint surface, black. Matching plastic edge.

**Frame**

Legs in texture coated die cast aluminium with black adjustable feet. Standard height 740 mm.

Height 900 mm at an additional cost.

Beams made of extruded anodized aluminium.

Beams ends 10 or 310 mm from the table top's short end. 31 cm by default.

**Options**

Other shapes, sizes and finishes on request.

\*Additional set-up cost, see options.

**When ordering, specify:**

Surface table top

Colour powder coat

Height

Beams distance to short side

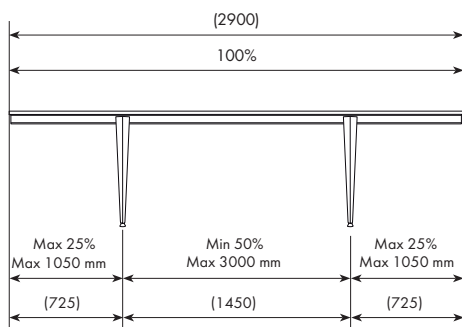
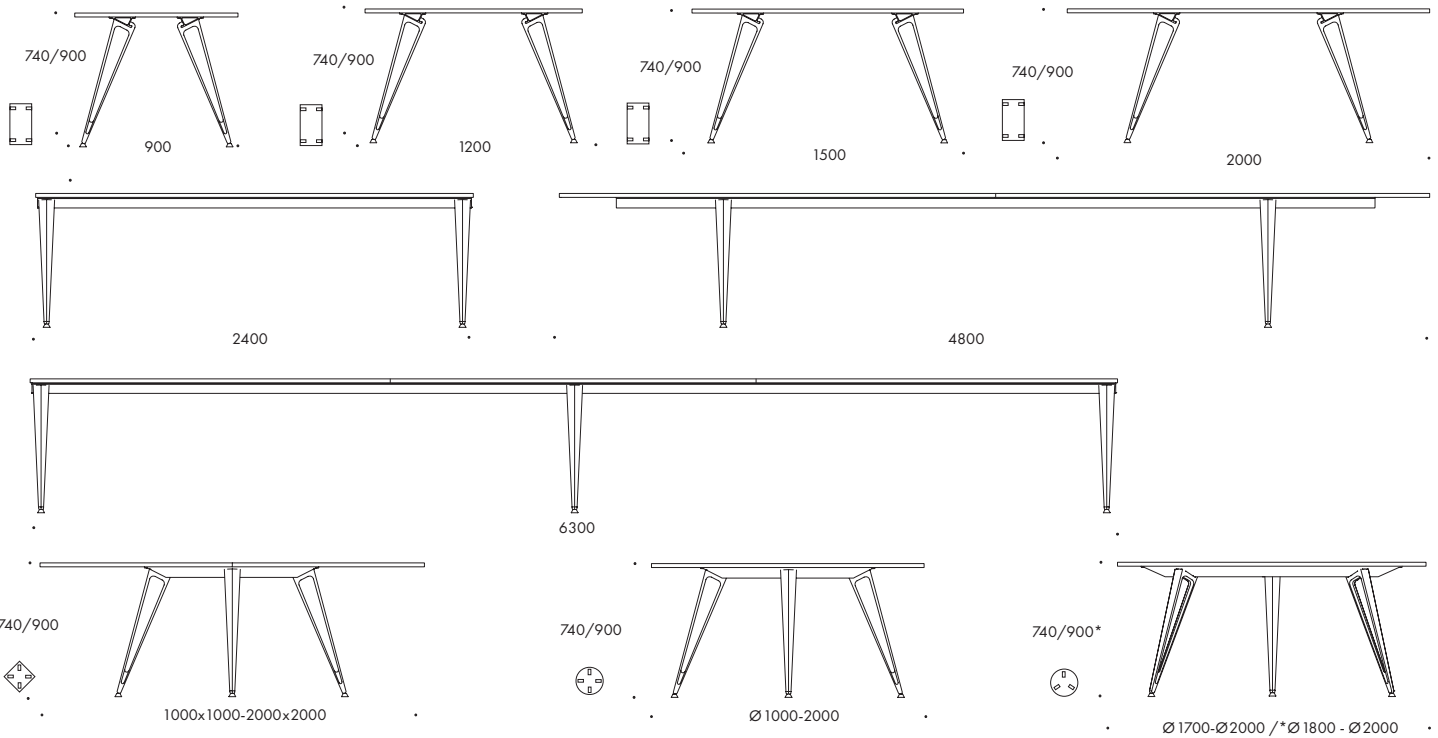

## ATTACH TABLE, RECTANGULAR

Art.no.	Description	Melamine 30	Perfect Sense 40	HPL 50	Linoleum 70	Veneer 80
135J1AA120	Table top W=900-1200, L=1600-2100, 4 Powder coated* legs	2346	2558	2998	3466	3466
135J1BA120	Table top W=900-1200, L=2101-2400, 4 Powder coated* legs	2558	2816	3376	3934	3934
135J1CA120	Table top W=900-1200, L=2401-2900, 4 Powder coated* legs	2847	3102	3783	4449	4449
135J1DA120	Table top W=900-1200, L=2901-3200, 4 Powder coated* legs	3829	4177	4918	5673	5673
135J1EA120	Table top W=900-1200, L=3201-3600, 4 Powder coated* legs	3981	4344	5192	6037	6037
135J1FA120	Table top W=900-1200, L=3601-4200, 4 Powder coated* legs	4298	4676	5673	6642	6642
135J1GA120	Table top W=900-1200, L=4201-4800, 4 Powder coated* legs	4708	5130	6310	7413	7413
135J1HA120	Table top W=900-1200, L=4801-5200, 6 Powder coated* legs	5418	5901	7203	8444	8444
135J1IA120	Table top W=900-1200, L=5201-5800, 6 Powder coated* legs	5720	6234	7671	9033	9033
135J1JA120	Table top W=900-1200, L=5801-6300, 6 Powder coated* legs	6613	7203	8775	10288	10288
135J1AB120	Table top W=1201-1400, L=1600-2100, 4 Powder coated* legs	2756	2998	3527	4071	4071
135J1BB120	Table top W=1201-1400, L=2101-2400, 4 Powder coated* legs	3026	3301	3965	4631	4631
135J1CB120	Table top W=1201-1400, L=2401-2900, 4 Powder coated* legs	3316	3618	4435	5206	5206
135J1DB120	Table top W=1201-1400, L=2901-3200, 4 Powder coated* legs	4344	4737	5630	6522	6522
135J1EB120	Table top W=1201-1400, L=3201-3600, 4 Powder coated* legs	4526	4933	5947	6945	6945
135J1FB120	Table top W=1201-1400, L=3601-4200, 4 Powder coated* legs	4873	5312	6506	7657	7657
135J1GB120	Table top W=1201-1400, L=4201-4800, 4 Powder coated* legs	5327	5811	7217	8533	8533
135J1HB120	Table top W=1201-1400, L=4801-5200, 6 Powder coated* legs	6143	6704	8246	9713	9713
135J1IB120	Table top W=1201-1400, L=5201-5800, 6 Powder coated* legs	6491	7065	8805	10410	10410
135J1JB120	Table top W=1201-1400, L=5801-6300, 6 Powder coated* legs	7445	8110	10000	11786	11786
135J1AC120	Table top W=1401-1600, L=1600-2100, 4 Powder coated* legs	2906	3163	3800	4419	4419
135J1BC120	Table top W=1401-1600, L=2101-2400, 4 Powder coated* legs	3208	3497	4298	5055	5055
135J1CC120	Table top W=1401-1600, L=2401-2900, 4 Powder coated* legs	3527	3844	4813	5720	5720
135J1DC120	Table top W=1401-1600, L=2901-3200, 4 Powder coated* legs	4587	4993	6069	7097	7097
135J1EC120	Table top W=1401-1600, L=3201-3600, 4 Powder coated* legs	4797	5236	6447	7595	7595
135J1FC120	Table top W=1401-1600, L=3601-4200, 4 Powder coated* legs	5192	5659	7083	8397	8397
135J1GC120	Table top W=1401-1600, L=4201-4800, 4 Powder coated* legs	5691	6203	7867	9397	9397
135J1HC120	Table top W=1401-1600, L=4801-5200, 6 Powder coated* legs	6553	7142	8973	10666	10666
135J1IC120	Table top W=1401-1600, L=5201-5800, 6 Powder coated* legs	6931	7550	9593	11452	11452
135J1JC120	Table top W=1401-1600, L=5801-6300, 6 Powder coated* legs	7928	8640	10878	12935	12935

## ATTACH, ROUND TABLE

Art.no.	Description	Melamine 30	Perfect Sense 40	HPL 50	Linoleum 70	Veneer 80
135J1X1120	Round table top Ø1000-1200, 4 Powder coated* legs	2286	2497	2665	2921	2921
135J1X2120	Round table top Ø1201-1500, 4 Powder coated* legs	2604	2847	3179	3556	3556
135J1X3120	Round table top Ø1501-1600, 4 Powder coated* legs	2892	3149	3647	-	-
135J1X4120	Round table top Ø1501-1700, 4 Powder coated* legs	-	-	-	4284	4284
135J1X5120	Round table top Ø1701-1800, 3 Powder coated* legs	-	-	-	4828	4828
135J1X6120	Round table top Ø1801-2000, 3 Powder coated* legs	-	-	-	-	5434

## ATTACH, SQUARE TABLE

Art.no.	Description	Melamine 30	Perfect Sense 40	HPL 50	Linoleum 70	Veneer 80
135J1Y1120	Square table top 1000x1000-1200x1200, 4 Powder coated* legs	2286	2497	2665	3026	3026
135J1Y2120	Square table top 1201x1201-1500x1500, 4 Powder coated* legs	2604	2830	3179	3724	3724
135J1Y3120	Square table top 1501x1501-1600x1600, 4 Powder coated* legs	2892	3149	3647	-	-
135J1Y4120	Square table top 1501x1501-1700x1700, 4 Powder coated* legs	-	-	-	4526	4526
135J1Y5120	Square table top 1701x1701-1800x1800, 4 Powder coated* legs	-	-	-	5418	-
135J1Y6120	Square table top 1701x1701-2000x2000, 4 Powder coated* legs	-	-	-	-	5463

## ADDITIONAL OPTIONS ATTACH

Art.no.	Description	Price 10
144M810220	Additional set-up cost Select Color/ color	353
135M210110	Attach legs H900, , price per leg	225
135M310110	Attach legs with sanded sides, price per leg	115
144M810450	Stained table top +5% on price for veneer	



**Table top**

Wood fibreboard in 19 mm white-grey melamine with matching edge.

**Frame**

Legs in flat oval powder coated or chrome-plated steel tubing 40x20 mm. Adjustable glides. Beams in rectangular electro-galvanized steel tubing 40x20 mm.

**Options**

Other shapes, sizes and finishes on request.

\*Additional set-up cost, see options.

**When ordering, specify:**

Colour powder coat

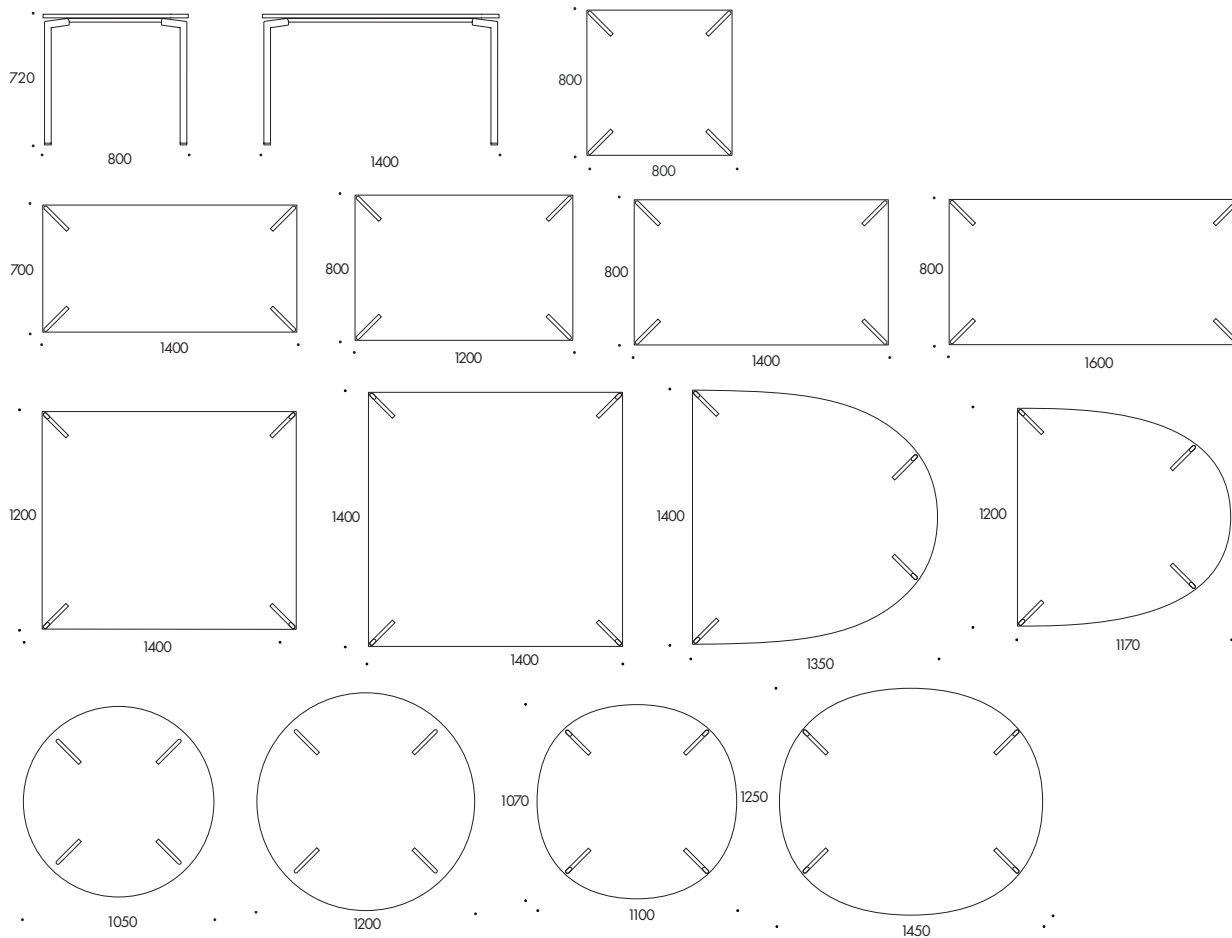

**CAMPUS TABLE, RECTANGULAR**

Art.no.	Description	Melamine		
		30	kg	m <sup>3</sup>
106J1A2120	Table top 1200x800, Powder coated* frame H720 mm	776	19.0	0.30
106J1A2140	Table top 1200x800, Chromed frame H720 mm	815	19.0	0.30
106J1A4120	Table top 1400x800, Powder coated* frame H720 mm	796	22.0	0.32
106J1A4140	Table top 1400x800, Chromed frame H720 mm	835	22.0	0.32
106J1A5120	Table top 1600x800, Powder coated* frame H720 mm	823	30.7	0.34
106J1A5140	Table top 1600x800, Chromed frame H720 mm	864	30.7	0.34
106J1A3120	Table top 1400x700, Powder coated* frame H720 mm	796	17.7	0.29
106J1A3140	Table top 1400x700, Chromed frame H720 mm	835	17.7	0.29
106J1C1120	Table top 1400x1200, Powder coated* frame H720 mm	931	42.0	0.45
106J1C1140	Table top 1400x1200, Chromed frame H720 mm	978	42.0	0.45

## CAMPUS TABLE, SQUARE

Art.no.	Description	Melamine		
		30	kg	m <sup>3</sup>
106J1A1120	Table top 800x800, Powder coated* frame H720 mm	728	13.6	0.18
106J1A1140	Table top 800x800, Chromed frame H720 mm	764	13.6	0.18
106J1C2120	Table top 1400x1400, Powder coated* frame H720 mm	982	37.0	0.53
106J1C2140	Table top 1400x1400, Chromed frame H720 mm	1031	37.0	0.53

## CAMPUS TABLE, HALF OVAL

Art.no.	Description	Melamine		
		30	kg	m <sup>3</sup>
106J1D1120	Table top 1200x1170 half oval, Powder coated* frame H720 mm	1215	35.5	0.38
106J1D1140	Table top 1200x1170 half oval, Chromed frame H720 mm	1331	35.5	0.38
106J1D2120	Table top 1400x1350 half oval, Powder coated* frame H720 mm	1274	47.5	0.51
106J1D2140	Table top 1400x1350 half oval, Chromed frame H720 mm	1395	47.5	0.51

## CAMPUS TABLE, OVAL

Art.no.	Description	Melamine		
		30	kg	m <sup>3</sup>
106J1E1120	Table top 1100x1070 oval, Powder coated* frame H720 mm	1097	29.5	0.32
106J1E1140	Table top 1100x1070 oval, Chromed frame H720 mm	1208	29.5	0.32
106J1E2120	Table top 1450x1250 oval, Powder coated* frame H720 mm	1124	45.5	0.49
106J1E2140	Table top 1450x1250 oval, Chromed frame H720 mm	1237	45.5	0.49

## ADDITIONAL OPTIONS CAMPUS TABLE

Art.no.	Description	Price 10
144M810220	Additional set-up cost Select Color/ color	353
144M610610	Linking device Campus, complete	69
144M617210	Suspension fittings for Campus & Spira chairs, Price per fastener	88

# CARGO

Design Gunilla Allard 1999/2007



## Shelves

3 shelves of frosted glass or black or white compact laminate as standard. Shelves in black leather at an additional cost.

Cargo Support: Top shelf is replaced with 2 stainless steel trays 290x323 mm incl. black rubber mat. Marble tray as an option

## Frame

Chromed or powder coated frame in Ø16 mm steel tubing. Leather-clad handles.

Cargo: Casters with thermoplastic rubber.

Cargo Support with Casters with polyurethane rollers.

\* Additional set-up cost, see options.

## When ordering, specify:

Surface shelves

Colour powder coat

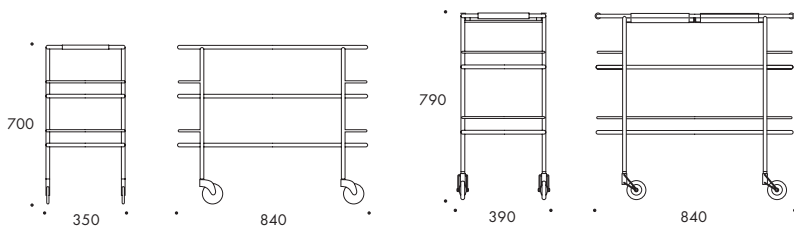

## CARGO TROLLEY

Art.no.	Description	Price		
		10	kg	m <sup>3</sup>
139K2A1240	3 shelves, Chromed frame	2611	17.5	0.25
139K2A1220	3 shelves, Powder coated* frame	2175	17.5	0.25

## CARGO SUPPORT TROLLEY

Art.no.	Description	Price		
		90	kg	m <sup>3</sup>
139K3A1440	2 shelves, upper shelf with stainless steel trays, Chromed frame	2912	20.0	0.30
139K3A1420	2 shelves, upper shelf with stainless steel trays, Powder coated* frame	2476	20.0	0.30

## ADDITIONAL OPTIONS CARGO

Art.no.	Description	Price
		10
144M810220	Additional set-up cost Select Color/ color	353
139M410410	Leather shelf upper. Price per pc	344
139M410510	Leather shelf middle and lower. Price per pc	344
139M310261	Cargo Support accessories, Stainless steel tray including rubber mat, 290x323 mm, Price per pc	155
139M410261	Cargo Support accessories, Stainless steel tray including rubber mat & marble tray, 290x323 mm, Price per pc	460
139M410210	Cargo Support accessories, Marble tray, 290x323 mm, Price per pc	372

# CHICAGO

Design Gunilla Allard 1999



## Shelves

Standard version: Shelves of frosted glass

## Options

Shelves in black or white compact laminate or black leather at an additional cost.

## Frame

Chromed or powder coated frame in Ø16 mm steel tubing with thermoplastic rubber casters.

\* Additional set-up cost, see options.

## When ordering, specify:

Surface shelves

Colour powder coat

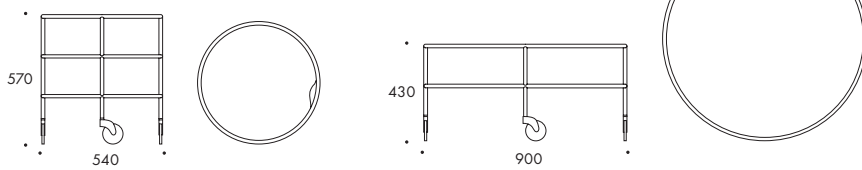

## CHICAGO TABLE, Ø540

Art.no.	Description	Price		
		10	kg	m <sup>3</sup>
123K1X1140	Ø540 mm with 3 shelves, Chromed frame	1830	13.8	0.18
123K1X1120	Ø540 mm with 3 shelves, Powder coated* frame	1611	13.8	0.18

## CHICAGO TABLE, Ø900

Art.no.	Description	Price		
		10	kg	m <sup>3</sup>
123K1X2140	Ø900 mm with 2 shelves, Chromed frame	2022	20.0	0.42
123K1X2120	Ø900 mm with 2 shelves, Powder coated* frame	1853	20.0	0.42

## ADDITIONAL OPTIONS CHICAGO

Art.no.	Description	Price
		10
144M810220	Additional set-up cost Select Color/ color	353
123M4X1210	Laminate shelf Ø540 upper. Price per pc	94
123M4X1310	Laminate shelf Ø540 middle & lower. Price per pc	94
123M4X1410	Leather shelf Ø540 upper. Price per pc	596
123M4X1510	Leather shelf Ø540 middle & lower. Price per pc	596
123M4X2210	Laminate shelf Ø900 upper. Price per pc	140
123M4X2310	Laminate shelf Ø900 middle & lower. Price per pc	140
123M4X2410	Leather shelf Ø900 upper. Price per pc	1199
123M4X2510	Leather shelf Ø900 middle & lower. Price per pc	1199



**Table top**

16 mm wood fibre board with high pressure laminate in standard colours white, black, light beige, light blue, yellow and brown. Bevelled and matching edge.

**Frame**

Pillar base of Ø140 mm tube and 5 mm footplate, powder coated in matching texture coat as standard. Felt glides.

**Other options**

Other sizes and finishes on request.

\* Additional set-up cost, see options.



**When ordering, specify:**

Colour of table

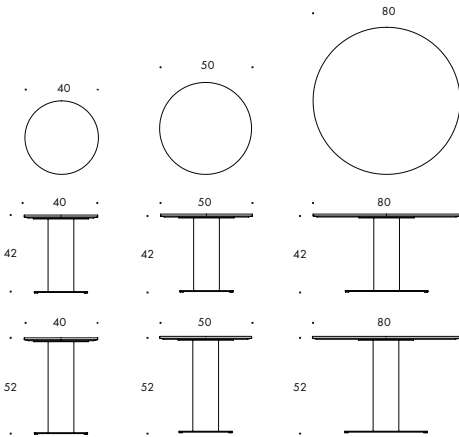

**CIAO TABLE Ø400**

Art.no.	Description	HPL		
		50	kg	m <sup>3</sup>
146J3A1120	Tabletop Ø 400 mm, Powder coated* frame H420 mm	659	10.0	0.09
146J4A1120	Tabletop Ø 400 mm, Powder coated* frame H520 mm	666	10.5	0.11

**CIAO TABLE Ø500**

Art.no.	Description	HPL		
		50	kg	m <sup>3</sup>
146J3A2120	Tabletop Ø 500 mm, Powder coated* frame H420 mm	659	11.0	0.09
146J4A2120	Tabletop Ø 500 mm, Powder coated* frame H520 mm	666	11.5	0.11

**CIAO TABLE Ø800**

Art.no.	Description	HPL		
		50	kg	m <sup>3</sup>
146J3A3120	Tabletop Ø 800 mm, Powder coated* frame H420 mm	902	19.9	0.16
146J4A3120	Tabletop Ø 800 mm, Powder coated* frame H520 mm	910	20.4	0.20

**ADDITIONAL OPTIONS CIAO**

Art.no.	Description	Price
		10
144M810220	Additional set-up cost Select Color/ color (Not for Ciao standard colors)	353



**Table top**

Ash or oak veneer alt. whitegrey or graphite melamine on 28 mm wood fibreboard. Matching edge. The veneer direction follows the long side of the table. On linked tops, the veneer is matched. When ordering the Integrated power port in veneer top, the hatches are made from a separate sheet of veneer, this may result in some difference in the grain from the table top.

**Frame**

Frame in polished or texture powder coated die cast aluminium with adjustable glides. Height 450, 730, 900 och 1100. On rectangular tables height 900 and 1100 at an additional cost.

Rectangular tables can be linked. Wiring possible in pillars.

**Limitations**

Round and aquare tables with width over 1000 mm only available with texture powder coated frame.

Tables in width over 1000 mm is not available in height 1100 mm.

**Options**

Other shapes, sizes and finishes on request.

\*Additional set-up cost, see options.

**When ordering, specify:**

Surface table top

Colour powder coat

Height

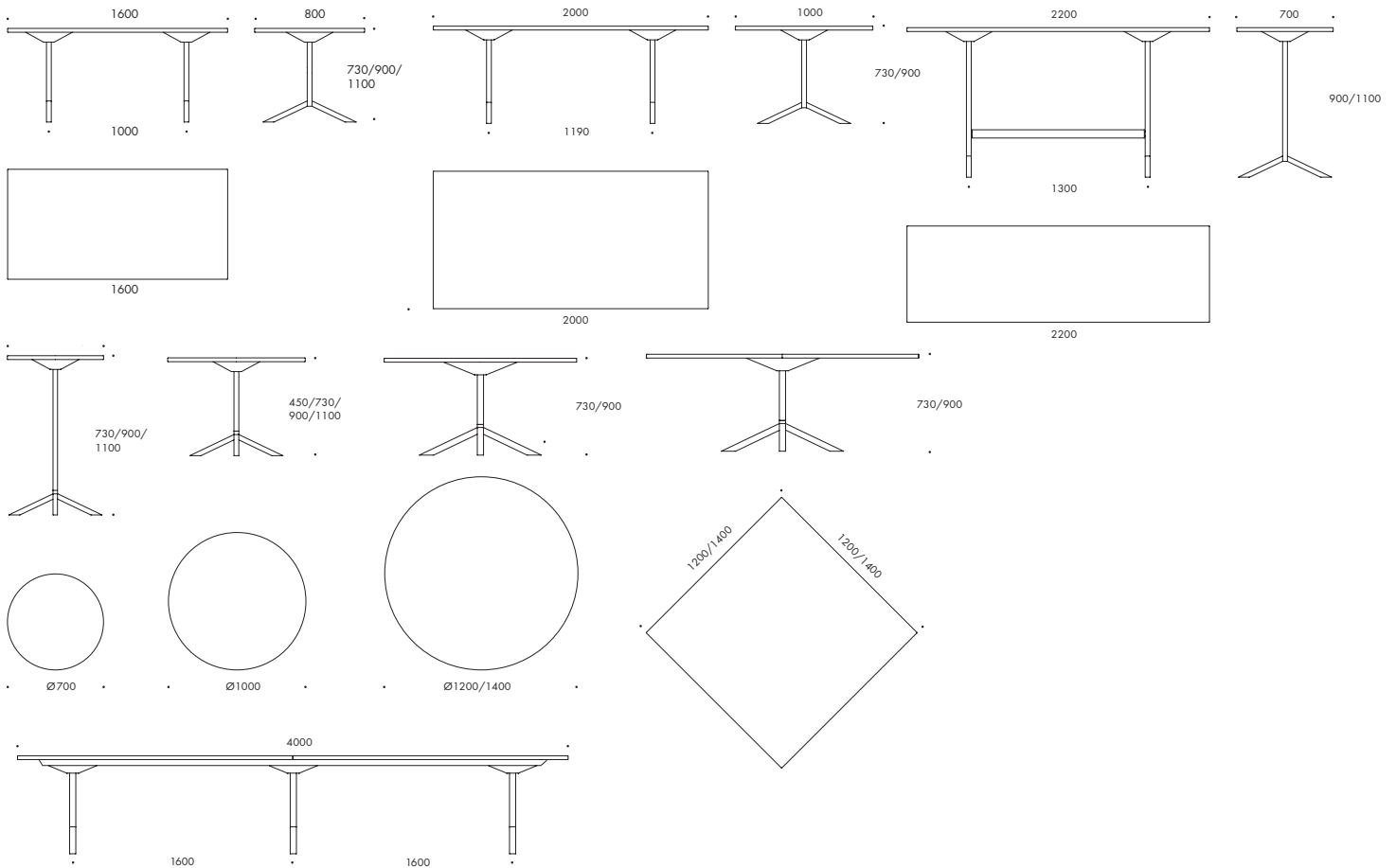



## FUNK RECTANGULAR

Art.no.	Description	Melamine	Veneer	kg	m <sup>3</sup>
		30	80		
141J1A2220	Table top 1600x800, Powder coated* frame	2129	2722	40.0	0.44
141J1A2260	Table top 1600x800, Polished aluminium frame	2359	2952	40.0	0.44
141J1B3220	Table top 2000x1000, Powder coated* frame	2748	3731	56.0	0.67
141J1B3260	Table top 2000x1000, Polished aluminium frame	2978	3960	56.0	0.67
141J1D4220	Table top 2400x1200, Powder coated* frame	3147	4336	88.0	1.15
141J1D4260	Table top 2400x1200, Polished aluminium frame	3376	4566	88.0	1.15
141J1D5220	Table top 2400x1400, Powder coated* frame	3565	5171	97.0	1.21
141J1D5260	Table top 2400x1400, Polished aluminium frame	3795	5401	97.0	1.21
141J1E3220	Table top 4000x1000, Powder coated* frame	5148	7112	104.0	0.99
141J1E3260	Table top 4000x1000, Polished aluminium frame	5491	7458	104.0	0.99
141J1G3220	Table top 6000x1000, Powder coated* frame	7549	10497	112.0	2.24
141J1G3260	Table top 6000x1000, Polished aluminium frame	8008	10956	112.0	2.24
141J1F4220	Table top 4800x1200, Powder coated* frame	5826	8203	160.0	1.82
141J1F4260	Table top 4800x1200, Polished aluminium frame	6169	8549	160.0	1.82
141J1H4220	Table top 7200x1200, Powder coated* frame	8504	12071	176.0	2.73
141J1H4260	Table top 7200x1200, Polished aluminium frame	8964	12529	176.0	2.73
141J1F5220	Table top 4800x1400, Powder coated* frame	6663	9878	178.0	1.93
141J1F5260	Table top 4800x1400, Polished aluminium frame	7008	10224	178.0	1.93
141J1H5220	Table top 7200x1400, Powder coated* frame	9763	14587	194.0	2.89
141J1H5260	Table top 7200x1400, Polished aluminium frame	10223	15045	194.0	2.89

## FUNK ROUND

Art.no.	Description	Melamine	Veneer	kg	m <sup>3</sup>
		30	80		
141J1X1220	Table top Ø700 mm, Powder coated* frame	1211	1632	22.0	0.39
141J1X1260	Table top Ø700 mm, Polished aluminium frame	1332	1754	22.0	0.39
141J1X2220	Table top Ø1000 mm, Powder coated* frame	1442	2016	29.0	0.31
141J1X2260	Table top Ø1000 mm, Polished aluminium frame	1587	2137	29.0	0.31
141J1X3220	Table top Ø1200 mm, Powder coated* frame	1927	3016	50.0	0.71
141J1X4220	Table top Ø1400 mm, Powder coated* frame	2110	3364	58.0	0.83

## FUNK SQUARE

Art.no.	Description	Melamine	Veneer	kg	m <sup>3</sup>
		30	80		
141J1Y2220	Table top 1200x1200, Powder coated* frame	1927	3016	56.0	0.71
141J1Y3220	Table top 1400x1400, Powder coated* frame	2110	3364	66.0	0.83

## ADDITIONAL OPTIONS FUNK

Art.no.	Description	Price 10
144M810220	Additional set-up cost Select Color/ color	353
141M210310	Height 900 (rectangular tables)	113
141M210410	Height 1100 (rectangular tables)	176
144M810350	Standard stain, smaller tables Ø700-1000	116
144M810450	Stained table top +5% on price for ash/oak	

**Table top**

28 mm wood fibreboard in ash or oak veneer with matching wooden edge or linoleum with matching plastic edge when possible. The veneer direction follows the long side of the table. On linked tops, the veneer is matched. When ordering the integrated power port in veneer top, the hatches are made from a separate sheet of veneer, this may result in some difference in the grain from the table top.

**Frame**

Solid wood legs in natural ash or oak. Stained at an additional cost. For tables in linoleum, legs in ash are included and legs in oak at an additional cost. Beams made of extruded anodized aluminium.

**Options**

Other shapes, sizes and finishes on request.

\*Additional set-up cost, see options.

When ordering, specify:

Surface table top

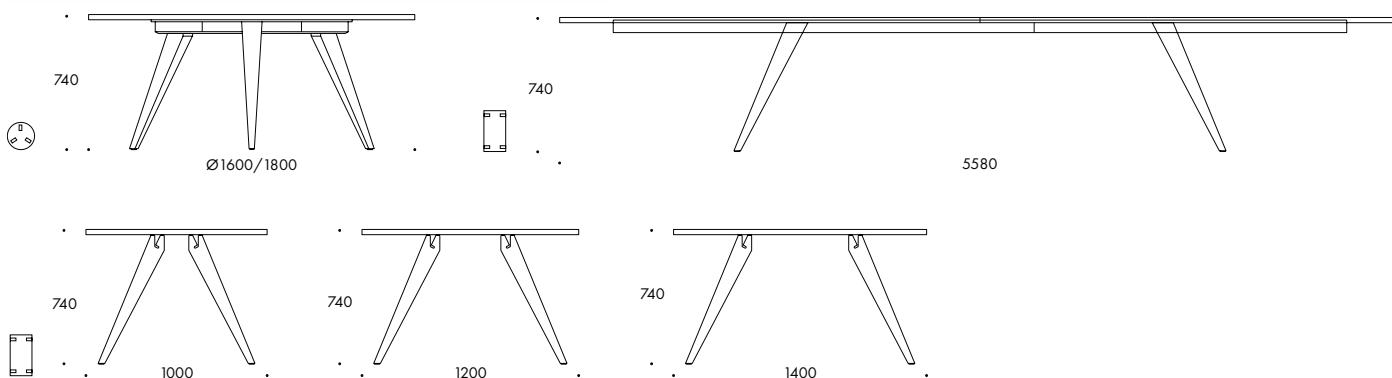

**PONTO TABLE RECTANGULAR**

Art.no.	Description	Linoleum 70	Oak 81	Ash 82
142J1A1250	Table top 2900x1000, Solid wood legs H740	7670	8458	7670
142J1B1250	Table top 3600x1000, Solid wood legs H740	9516	10305	9516
142J1C1250	Table top 4200x1000, Solid wood legs H740	10406	11195	10406
142J1D1250	Table top 4800x1000, Solid wood legs H740	10536	11325	10536
142J1E1250	Table top 5580x1000, Solid wood legs H740	11162	11949	11162
142J1A2250	Table top 2900x1200, Solid wood legs H740	7868	8658	7868
142J1B2250	Table top 3600x1200, Solid wood legs H740	10533	11321	10533
142J1C2250	Table top 4200x1200, Solid wood legs H740	10584	11373	10584
142J1D2250	Table top 4800x1200, Solid wood legs H740	10708	11497	10708
142J1E2250	Table top 5580x1200, Solid wood legs H740	12506	13295	12506
142J1A3250	Table top 2900x1400, Solid wood legs H740	8129	8917	8129
142J1B3250	Table top 3600x1400, Solid wood legs H740	10946	11736	10946
142J1C3250	Table top 4200x1400, Solid wood legs H740	11898	12687	11898
142J1D3250	Table top 4800x1400, Solid wood legs H740	12464	13253	12464

**PONTO TABLE ROUND**

Art.no.	Description	Linoleum 70	Oak 81	Ash 82
142J1X1250	Table top Ø1600 mm, Solid wood legs H740	6359	6951	6359
142J1X2250	Table top Ø1800 mm, Solid wood legs H740	7297	7888	7297

**ADDITIONAL OPTIONS PONTO**

Art.no.	Description	Price
142M310150	Additional for oak legs with Linoleum. Price per leg	208
142M810250	Additional for stained legs. Price per leg	126
144M810450	Stained table top +5% on price for ash/oak	



**Table top**

"Basic" in white grey melamine or black Perfect Sense melamine on 22 mm MDF with matching plastic edge.

"Flexible" white grey hpl on 25 mm poplar plywood. Light grey plastic edge.

Some sizes in ash veneer with matching wooden edge.

**Frame**

Folding leg arches alt. T-legs at an additional cost in Ø30 mm welded conical steel tubing, powder coated or chromed.

Fittings and feet in light grey plastic as standard, also available in black at an additional cost.

**Options**

Other shapes, sizes and finishes on request.

\* Additional set-up cost, see options.

**When ordering, specify:**

Surface table top

Colour powder coat

Selection leg arches or T-leg

Selection light grey or black plastic details and feet

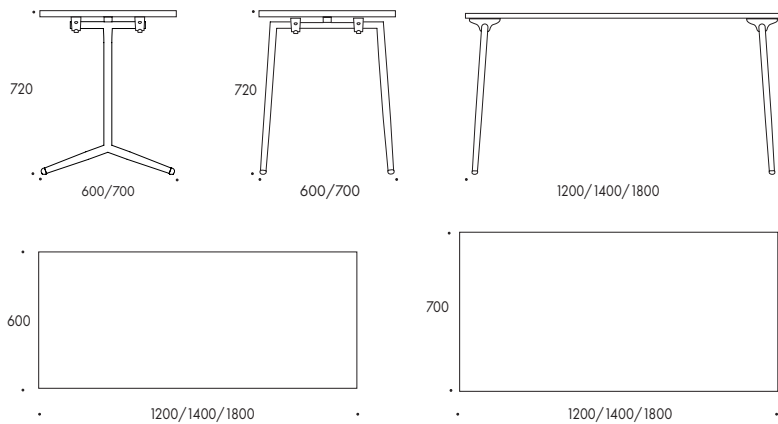

**QUICKLY BASIC TABLE, L1200**

Art.no.	Description	Melamine	Perfect	kg	m <sup>3</sup>
		30	Sense 40		
143J2A2120	Table top 1200x600, Powder coated* legs H720	698	904	19.2	0.09
143J2A2140	Table top 1200x600, Chromed legs H720	719	957	19.2	0.09
143J2A3120	Table top 1200x700, Powder coated* legs H720	706	1028	21.2	0.12
143J2A3140	Table top 1200x700, Chromed legs H720	750	1088	21.2	0.12

**QUICKLY BASIC TABLE, L1400**

Art.no.	Description	Melamine	Perfect	kg	m <sup>3</sup>
		30	Sense 40		
143J2B2120	Table top 1400x600, Powder coated* legs H720	722	1024	21.5	0.11
143J2B2140	Table top 1400x600, Chromed legs H720	766	1084	21.5	0.11
143J2B3120	Table top 1400x700, Powder coated* legs H720	755	1144	23.5	0.13
143J2B3140	Table top 1400x700, Chromed legs H720	802	1279	23.5	0.13

**QUICKLY FLEXIBLE TABLE, L1200**

Art.no.	Description	HPL	Veneer	kg	m <sup>3</sup>
		50	80		
143J3A2120	Table top 1200x600, Powder coated* legs H720	1180	1258	14.4	0.09
143J3A2140	Table top 1200x600, Chromed legs H720	1239	1316	14.4	0.09
143J3A3120	Table top 1200x700, Powder coated* legs H720	1241	1303	16.3	0.12
143J3A3140	Table top 1200x700, Chromed legs H720	1304	1361	16.3	0.12

**QUICKLY FLEXIBLE TABLE, L1400**

Art.no.	Description	HPL	Veneer	kg	m <sup>3</sup>
		50	80		
143J3B2120	Table top 1400x600, Powder coated* legs H720	1259	1318	15.9	0.11
143J3B2140	Table top 1400x600, Chromed legs H720	1323	1378	15.9	0.11
143J3B3120	Table top 1400x700, Powder coated* legs H720	1394	1395	18.0	0.13
143J3B3140	Table top 1400x700, Chromed legs H720	1463	1457	18.0	0.13

## QUICKLY FLEXIBLE TABLE , L1800

Art.no.	Description	HPL	Veneer	kg	m <sup>3</sup>
		50	80		
143J3C2120	Table top 1800x600, Powder coated* legs H720	1632	1610	18.8	0.15
143J3C2140	Table top 1800x600, Chromed legs H720	1715	1683	18.8	0.15
143J3C3120	Table top 1800x700, Powder coated* legs H720	1660	1656	21.4	0.17
143J3C3140	Table top 1800x700, Chromed legs H720	1744	1729	21.4	0.17

## QUICKLY TRANSPORT TROLLEY

Art.no.	Description	Price		
		10	kg	m <sup>3</sup>
144K210217	Trolley, black powder coated	1608	17.2	0.41

## ADDITIONAL OPTIONS QUICKLY

Art.no.	Description	Price		
		10	kg	m <sup>3</sup>
144M810220	Additional set-up cost Select Color/ color	353		
143M310310	T-legs	96		
144M810350	Standard stain, smaller tables, cost per table	116		
143M310210	Black plastic details	60		
143M110210	Casters, price per pair, (not for T-legs)	29		
144M610610	Linking device complete	69		
143M610117	Wall suspension brackets	71		

## TENSION

Design Gustav Winsth 2024



### Shelves

2 shelves of 2mm powder coated or stainless steel sheet. Matching piqué leather cover on the lower shelf at additional cost.

### Frame

Chromed or powder coated frame in Ø32 mm steel tubing. Caster suspension in 2mm powder coated steel sheet. Caster bracket in die-cast zinc, powder-coated. Casters in softened PE, white RAL9010 with black Lammhults logo.

\*Additional set-up cost, see options.

### When ordering, specify:

Surface shelves

Colour powder coat

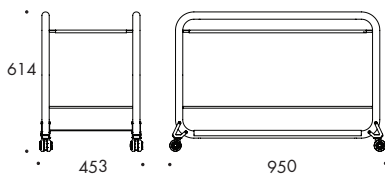

## TENSION TROLLEY

Art.no.	Description	Price		
		10	kg	m <sup>3</sup>
149K1A1140	2 shelves, Chromed frame	1417	22.4	0.33
149K1A1120	2 shelves, Powder coated* frame	1299	22.4	0.33

## ADDITIONAL OPTIONS TENSION

Art.no.	Description	Price		
		10	kg	m <sup>3</sup>
149M710161	Stainless steel shelves	142		
149M710110	Leather mat (anti-slip)	142		
144M810220	Additional set-up cost Select Color/ color	353		

## POWER & COMMUNICATION PORTS



GEMINI



VENID



INTEGRATED



PIX

**GEMINI Long** - Double-opened lid in natural anodised aluminum alt. white or black lacquered. Outer dimensions 409x148 mm. Outlets 5 x EI, 1 x USB-A, 1 x USB-C, 1 x HDMI, 2 x RJ-45, 3m cable, incl. cable tray in black metal. Note! UK=3 x EI.

**GEMINI Short** - Double-opened lid in natural anodised aluminum alt. white or black lacquered. Outer dimensions 308x144 mm. Outlets 4 x EI, 1 x USB-A, 1 x USB-C, 1 x HDMI, 1 x RJ-45, 3m cable, incl. cable tray in black metal. Note! UK=3 x EI.

**VENID** - Built-in frame with insert of equal material as tabletop. Outer dimension 351x180 mm. Outlets 4 x EI, 1 x USB-A, 1 x USB-C, 1 x HDMI, 1 x RJ-45, 3m cable, incl. cable tray in black metal. Note! UK=3x EI.

**INTEGRATED Long** - Integrated cable tray with lids in the same material as the table surface. Outer dimensions 550x170 mm. Outlets 5 x EI, 1 x USB-A, 1 x USB-C, 1 x HDMI, 2 x RJ-45, 3m cable, incl. cable tray in black metal.

**INTEGRATED Short** - Integrated cable tray with lids in the same material as the table surface. Outer dimensions 350x170 mm. Outlets 4 x EI, 1 x USB-A, 1 x USB-C, 1 x HDMI, 1 x RJ-45, 3m cable, incl. cable tray in black metal.

**PIX alt. 1** - Single module with 1x EI, black, Ø71 mm.

**PIX alt. 2** - Single module with 1 x USB-A 18W and 1 x USB-C 22W, black, Ø71 mm.

### Options

Graphite felt tray including mounting brackets and cable channel in felt at an additional cost  
Other alternatives on request.

When ordering, specify:

Colour lids for Gemini

### GEMINI LID

Art.no.	Description	Price
136O210220	Long with electric supply units, Lid Natural anodised aluminum or lacquered, Black cable tray	1039
136O210320	Long without electric supply units, Lid Natural anodised aluminum or lacquered	466
136O310220	Short with electric supply units, Lid Natural anodised aluminum or lacquered, Black cable tray	966
136O310320	Short without electric supply units, Lid Natural anodised aluminum or lacquered	411

### VENID

Art.no.	Description	Price
136O610217	Lid with black frame and inlay in the same material as the table, with electric supply units, Black cable tray	1220
136O610317	Lid with black frame and inlay in the same material as the table, without electric supply units	567

### INTEGRATED

Art.no.	Description	Price
136O410210	Long with lid in the same material as the table, with electric supply units, Black cable tray	1330
136O510210	Short with lid in the same material as the table, with electric supply units, Black cable tray	1305
136O410310	Long with lid in the same material as the table, without electric supply units	656
136O510310	Short with lid in the same material as the table, without electric supply units	656

### PIX

Art.no.	Description	Price
136O710217	Pix, power	243
136O710417	Pix, Dual USB-A/ -C	348

### ADDITIONAL OPTIONS POWER & COMMUNICATION PORTS

Art.no.	Description	Price
136M210110	Cable tray in anthracite felt, With mounting brackets. To be used beneath power unit	162
136M210310	Cable channel in anthracite felt, 120 cm. To be used between power units	149



**Frame**

Foot plate in texture powder coated, cast steel. Adjustable feet. Optional swivel footplate.  
 Frame of mitred 28 mm texture powder coated steel tubing in width 500 or 750 mm.  
 Clothes stand incl. clothes rail in chrome-plated oval tubing 30x15mm, at an additional cost.  
 Hooks in black or white polyamide.

**Note**

Foot plate only available in white and black texture powder coat as standard.

*When ordering, specify:*

Colour powder coat

Color hooks

Colour foot plate

*\*Additional set-up cost applies for powder coat in our Select Color range, see options.*

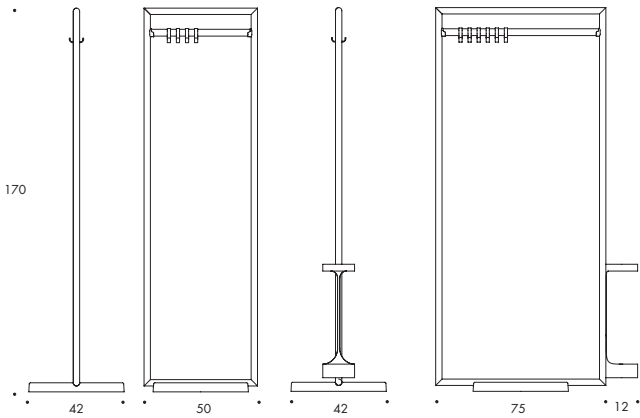

**ADD CLOTHES STAND**

Weight (kg) 20.0      Freight volume (m³) 0.25

Art.no.	Description	Price
101L210220	W500, Incl 4 hooks in Polyamide, Texture powder coat*	822
101L210320	W750, Incl 6 hooks in Polyamide, Texture powder coat*	889

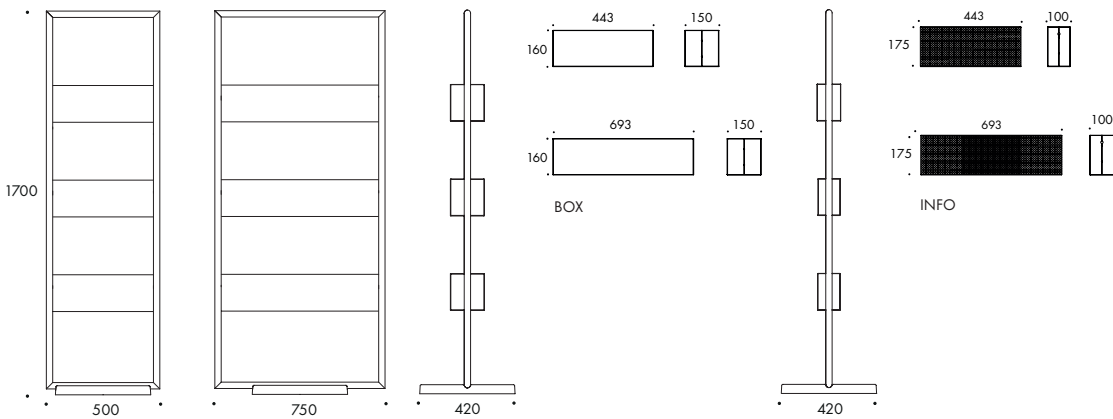

**ADD BOX STAND**

Weight (kg) 22.0      Freight volume (m³) 0.30

Art.no.	Description	Price
101L310220	W500, Incl 3 metal baskets, Texture powder coat*	1076
101L310320	W750, Incl 3 metal baskets, Texture powder coat*	1128

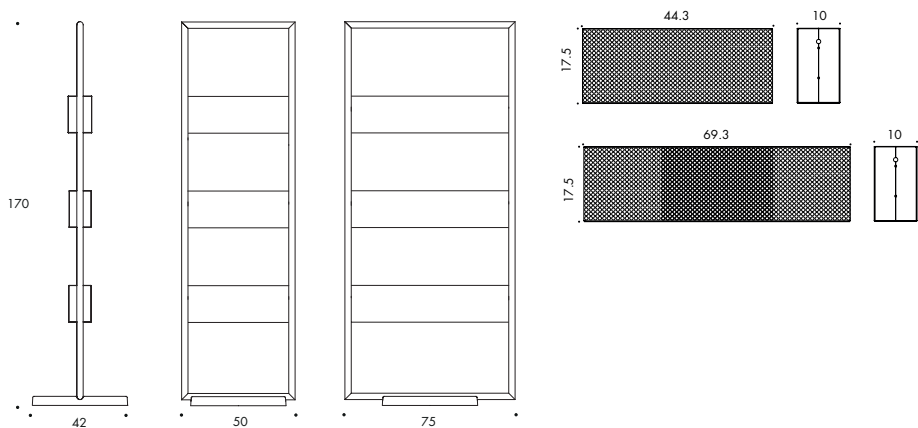

#### ADD INFO STAND

Weight (kg) 22.0      Freight volume (m<sup>3</sup>) 0.30

Art.no.	Description	Price
101L410220	W500, Incl 3 perforated metal baskets, Texture powder coat*	1165
101L410320	W750, Incl 3 perforated metal baskets, Texture powder coat*	1221

#### ADDITIONAL OPTIONS ADD CLOTHES, BOX & INFO STAND

Art.no.	Description	Price
144M810220	Additional set-up cost Select Color/ color	353
101M210220	Swivel footplate, Black or white texture powder coat*	175
101M310250	Clothes rail in ash	51
101M410220	Umbrella stand	155
101M810210	Clothes hook, white or black Polyamide, price per hook	18
101M710210	Linking device, white or black, price per set of two	31
101M610210	Plant insert 500 mm, price per pc	47
101M610310	Plant insert 750 mm, price per pc	57

## S70-12

Design Börge Lindau & Bo Lindekrantz 1968



### Frame

35 mm powder coated steel tubing.  
Foot of powder coated steel.  
Rotating top with 7 hooks with plastic end caps

When ordering, specify:

Colour powder coat

\*Additional set-up cost applies for powder coat in our Select Color range, see options.

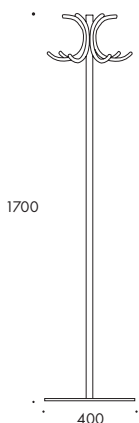

### S70-12, COAT HANGER

Weight (kg) 13.0      Freight volume (m³) 0.10

Art.no.	Description	Price
119L110120	Coat Hanger H1700, Powder coated*	10
		593

### ADDITIONAL OPTIONS S70-12

Art.no.	Description	Price
144M810220	Additional set-up cost Select Color/ color	10
		353



## SPARE PARTS

Here you will find the most commonly requested spare parts for existing as well as discontinued models. Do not hesitate to contact us at +46 472-269500 or order@lammhults.se if there is something you are missing. \*Additional set-up cost applies for powder coat in our Select Color range, see options.

### SPARE PARTS GEOFANTI

Art.no.	Description	Cat. B	Cat. C	Cat. D	Cat. E	Cat. F
		22	23	24	25	26
150R841210	Geofanti upholstery Recover 1-seater with back	729	923	984	1241	On request
150R842210	Geofanti upholstery Recover right unit	931	1180	1259	1590	On request
150R843210	Geofanti upholstery Recover left unit	931	1180	1259	1590	On request
150R844510	Geofanti upholstery Recover 1-seater without back	549	691	737	927	On request
150R845210	Geofanti upholstery Recover 2-seater sofa	1134	1441	1540	1947	On request
150R846210	Geofanti upholstery Recover 2-seater with short back right	884	1113	1187	1493	On request
150R847210	Geofanti upholstery Recover 2-seat with short back left	884	1113	1187	1493	On request
150R848510	Geofanti upholstery Recover 2-seater without back	795	1010	1078	1363	On request

### SPARE PARTS ADD / ADD MOVE

Art.no.	Description	Price	Cat. B	Cat. C	Cat. D	Cat. E	Cat. F
		10	22	23	24	25	26
101N130110	Add upholstered seat		307	337	346	385	405
101N135110	Add upholstered back		361	389	398	438	459
101N121110	Add seat black polyurethane	214					
101N113120	Add frame powder coat* H460 with plastic glides	284					
101N113220	Add frame powder coat* H630 with plastic glides	298					
101N113320	Add frame powder coat* H780 with plastic glides	319					
101N113140	Add frame chrome H460 with plastic glides	345					
101N113240	Add frame chrome H630 with plastic glides	383					
101N113340	Add frame chrome H780 with plastic glides	395					
101N110110	Add stacking protection	65					
101N111110	Add Move Casters with threaded pin, black, 5 pcs	166					
101N111210	Add Move Casters with threaded pin, chrome, 5 pcs	178					

### SPARE PARTS ARCHAL/ATLAS/GRADE/CAROUSEL

Art.no.	Description	Price
		10
144N111110	Castors, plain pin, black, 5 pcs. Fits Archal/Atlas/Grade/Carousel	166
144N111210	Castors, plain pin, white, 5 pcs. Fits Archal/Atlas/Grade/Carousel	166
144N111310	Castors, plain pin, graphite, 5 pcs. Fits Archal/Atlas/Grade/Carousel	166

### SPARE PARTS CAMPUS

Art.no.	Description	Price	Price
		10	80
106N122110	Campus wooden seat		On request
106N135110	Campus upholstered seat		On request
106N112110	Campus plastic glide, 4 pcs		35
106N112210	Campus felt glide, 4 pcs		37
106N112310	Campus teflon glide, 4 pcs		37

### SPARE PARTS CAMPUS AIR

Art.no.	Description	Price
		10
107N121110	Campus Air seat in polyamide	149
107N127110	Campus Air back in polyamide	149
107N110114	Campus Air short armrest in polyamide	67

### SPARE PARTS CARGO

Art.no.	Description	Price
		10
139N110110	Cargo shelf black compact laminate	449
139N110210	Cargo shelf white compact laminate	449
139N110310	Cargo shelf frosted glass	449
139N110410	Cargo Support rubber mat, black, 290x323 mm	71
139N111110	Castors, plain pin, black, 4 pcs. Fits Cargo/Chicago (Cannot be replaced in a customer environment.)	117

## SPARE PARTS CHICAGO

Art.no.	Description	Price 10
123N110110	Chicago shelf of frosted glass Ø900. Price per pce	538
123N110210	Chicago laminate shelf Ø900. Price per pce	538
123N110310	Chicago shelf of frosted glass upper Ø540. Price per pce	411
123N110410	Chicago shelf of frosted glass middle & lower. Ø540. Price per pce	296
123N110510	Chicago laminate shelf Ø540 upper. Price per pce	411
123N110610	Chicago laminate shelf Ø540 middle & lower. Price per pce	296
139N111110	Casters, plain pin, black, 4 pcs. Fits Cargo/Chicago (Cannot be replaced in a customer environment.)	117

## SPARE PARTS CINEMA

Art.no.	Description	Price 10
124R130110	Cinema easy chair, upholstery excl. armrests. (Requires upholsterer)	On request

## SPARE PARTS COMET

Art.no.	Description	Price 10
109N111110	Casters with threaded pin, black, 5 pcs. Fits Comet	166
109N111210	Casters with threaded pin, white, 5 pcs. Fits Comet	166
109N111310	Casters with threaded pin, chrome, 5 pcs. Fits Comet	178

## SPARE PARTS GRADE

Art.no.	Description	Price 10
111N130110	Grade upholstered seat	On request
111N112110	Grade plastic glides, complete set	35
111N112210	Grade felt glides, complete set	37
111N112310	Grade teflon glides, complete set	37

## SPARE PARTS PENNE

Art.no.	Description	Price 10
113N112110	Penne plastic glides, complete set	35
113N112210	Penne felt glides, complete set	37
113N112310	Penne teflon glides, complete set	37

## SPARE PARTS QUICKLY

Art.no.	Description	Price 10
143N112110	Quickly glides, grey, 4 pcs	49
143N112210	Quickly glides, black, 4 pcs	64

## SPARE PARTS SPIRA

Art.no.	Description	Price 10
115N114110	Spira armrest in Woodfibre (dark) (Attached with a pop rivet, but a screw is included.)	60
115N114210	Spira armrest in Woodfibre (light) (Attached with a pop rivet, but a screw is included.)	60
115N112110	Spira plastic glides complete set, 4-leg frame	35
115N112210	Spira felt glides complete set, 4-leg frame	37
115N112310	Spira teflon glides complete set, 4-leg frame	51
115N112410	Spira plastic glides complete set, 4-feet	55
115N111110	Casters, threaded pin, polished, 5 pcs. Fits Spira	178

## SPARE PARTS S70

Art.no.	Description	Price 10	Price 80
119N122110	S70-3 seat natural ash		322
119N112110	S70-3 Fittings for replacing a plastic seat with a wooden seat.	35	
119N130110	S70-4/5 upholstered cushion		On request

## SPARE PARTS TABURETT

Art.no.	Description	Price 10
120N121110	Taburett seat in ABS plastic	101
120N112110	Taburett plastic glides complete set	35
120N112210	Taburett felt glides complete set	37

## SPARE PARTS X75-2

Art.no.	Description	Price
117N130110	X75-2 seat fabric, incl. black end caps for the seats frame	On request
117N135110	X75-2 back fabric, incl. black end caps for the backs frame	On request
117N133110	X75-2 upholstered cushion	On request
117N110110	X75-2 end caps set/chair black, incl. 2pcs + 4 pcs	50

## ADDITIONAL OPTIONS SPARE PARTS

Art.no.	Description	Price
144M810220	Additional set-up cost Select Color/ color	353