

---

## **BuzziJet 230V** **Product Specification Sheet**

---

This document contains technical information about the BuzziJet

---







## Powerful acoustic circle of light

Form follows function with BuzziJet, an intentionally simple design based on the principles of geometric acoustics. Wide in diameter, this cylindrical design allows sound waves to bounce back-and-forth within the radius of its circular body, and in turn mitigates noise. BuzziJet is considerable in size, yet appears lightweight and airy thanks to its upholstered foam core. Its soft presence evokes a majestic sense of serenity. Concealed inside the body, a powerful light source emits warm, pleasant light.

Design by BuzziSpace Studio

---

## General

-  Ceiling Suspended  
S | M | XL | XXL
-  Upholstered acoustic foam shade  
LED disk  
Powder coated metal ceiling canopy in white (RAL 9010)  
Transparent power cable
-  IP20 Dry Usage
-  Assembled
-  If installing on suspended ceiling, verify load capacity prior to installation

---

## Certifications



---

## Acoustics



Absorption



Diffusion



Low tone



Mid tone



High tone

---

## Content

Configurations	3	Fabrics	9
Components	5	Dimensions	12
Photometric Data	7	Acoustics	16

# Configurations

---

## BuzziJet S

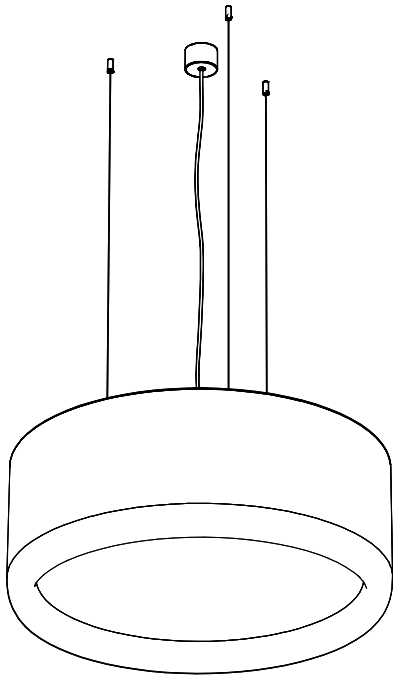

- ◆ Ceiling Suspended
- Upholstered acoustic foam shadeLED disk
- 🌲 Powder coated metal ceiling canopy and frame in white (RAL 9010)
- Transparent power cable
  
- Wattage: 29W
- Input Voltage: 230V
- Input Frequency: 50/60Hz
- 💡 Lumen Output: 2545 lumen
- Color Temperature: 3000K (4000K on request)
- Color Rendering Index: >90
- Dimmable: 1-10V Protocol (DALI on request)
- Unified Glare Rating: 22 (19 on request)
  
- ✂ Ø 80 cm H: 22,5 cm
- ⚖ 13 kg
- ⋮ Ceiling Suspended Straight or Split
- ⋮ Fixing System Screw
- 3x black or alu cables 2 - 4 m
  
- ⚠ If installing on suspended ceiling, verify load capacity prior to installation

---

## BuzziJet M

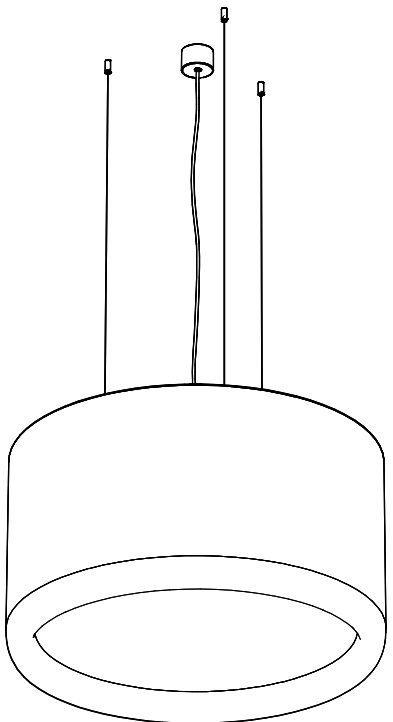

- ◆ Ceiling Suspended
- Acoustic upholstered foam shade LED disk
- 🌲 Powder coated metal ceiling canopy and frame in white (RAL 9010)
- Transparent power cable
  
- Wattage: 29W
- Input Voltage: 230V
- Input Frequency: 50/60Hz
- 💡 Lumen Output: 2545 lumen
- Color Temperature: 3000K (4000K on request)
- Color Rendering Index: >90
- Dimmable: 1-10V Protocol (DALI on request)
- Unified Glare Rating: 22 (19 on request)
  
- ✂ Ø 80 cm H: 45 cm
- ⚖ 15 kg
- ⋮ Ceiling Suspended Straight or Split Fixing System Screw
- 3x black or alu cables 2 - 4 m
  
- ⚠ If installing on suspended ceiling, verify load capacity prior to installation

---

## BuzziJet XL

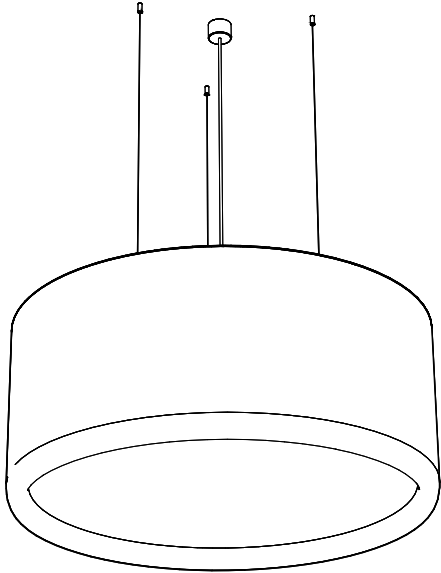

- ◆ Ceiling Suspended
- Acoustic upholstered foam shade LED disk
- 🌲 Powder coated metal ceiling canopy and frame in white (RAL 9010)
- Transparent power cable
  
- Wattage: 29W
- Input Voltage: 230V
- Input Frequency: 50/60Hz
- Lumen Output: 2545 lumen
- 💡 Color Temperature: 3000K (4000K on request)
- Color Rendering Index: >90
- Dimmable: 1-10V Protocol (DALI on request)
- Unified Glare Rating: 22 (19 on request)
  
- ✂ Ø 120 cm H: 52,5 cm
- ⚖ 17 kg
  
- Ceiling Suspended Straight
- ⋮ Fixing System Screw
- 3x black or alu cables 2 - 4 m
  
- ⚠ If installing on suspended ceiling, verify load capacity prior to installation

---

## BuzziJet XXL

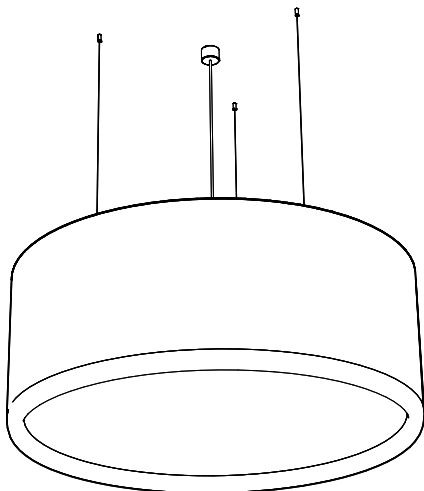

- ◆ Ceiling Suspended
- Acoustic upholstered foam shade LED disk
- 🌲 Powder coated metal ceiling canopy and frame in white (RAL 9010)
- Transparent power cable
  
- Wattage: 70W
- Input Voltage: 230V
- Input Frequency: 50/60Hz
- Lumen Output: 6232 lumen
- 💡 Color Temperature: 3000K
- Color Rendering Index: >90
- Dimmable: 1-10V Protocol
- Unified Glare Rating: 23
  
- ✂ Ø 150 cm H: 60 cm
- ⚖ 26 kg
  
- Ceiling Suspended Straight
- ⋮ Fixing System Screw
- 3x black or alu cables 2 - 4 m
  
- ⚠ If installing on suspended ceiling, verify load capacity prior to installation

# Components

---

## Light source



The Light source is wrapped with an upholstered ring in the same fabric as the foam shade.

The PMMA diffuser ensures an optimal light spread and efficiency. It creates a very diffuse light surface without any dottiness.

The light source of the BuzziJet is a LED PCB, containing 104 medium power LED's for the S | M | XL and for the XXL 248 medium power LED's

---

## Ceiling canopy and power cord



Suspension set consists of a:

- metal ceiling canopy powder coated in white
- transparent power cable (length 4 m)
- separate metal cables to suspend the BuzziJet (in alu or black 2 m or 4 m)

---

# Mounting

## Ceiling Suspended Straight

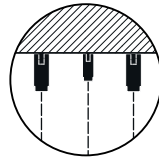
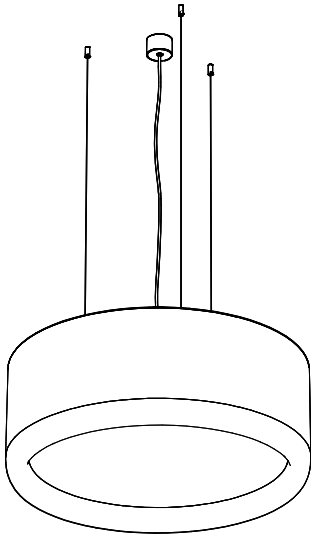

Ceiling Suspended Straight  
Fixing System Screw with 3 cables of 2 or 4 m  
(black or alu)  
Min. distance of shade to ceiling is 10 cm

## Ceiling Suspended Split (only available for BuzziJet S | M)

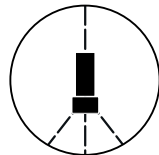
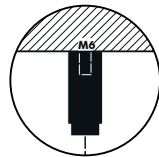
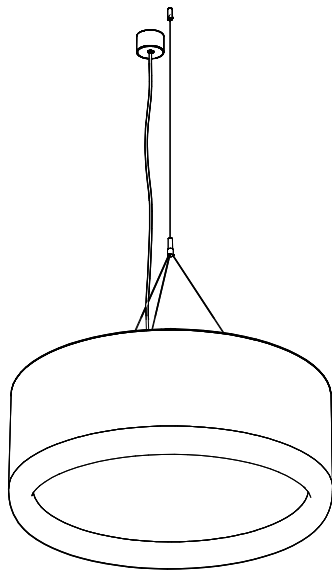

Ceiling Suspended Split  
Fixing System Screw with 3 split cables and 1 main  
cable, total length of 2 m or 4 m (black or alu)  
Min. distance of shade to ceiling is 50 cm

# Photometric Data

To enlight your workplace or room with optimal lux levels take following measures into account.

## BuzziJet S | M | XL

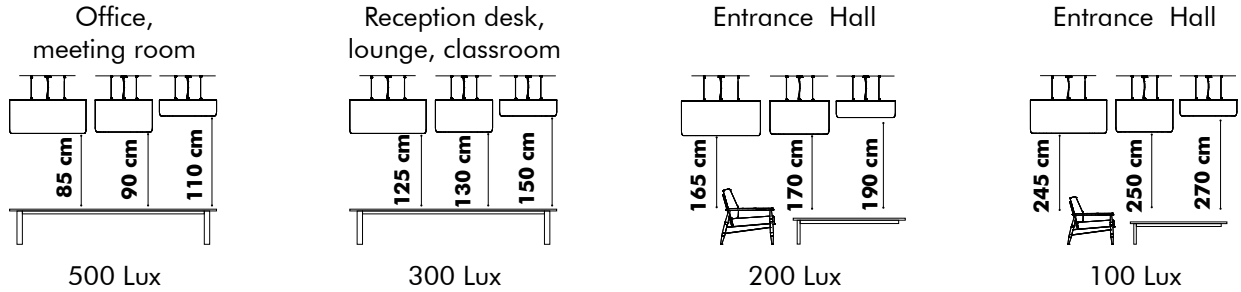

To ensure a continuous light spread into account take following distances inbetween the BuzziJets S | M | XL



According to EN12464

### Specification overview BuzziJet S | M | XL

#### Standard:

S | M | XL: 3000K | UGR 22 | 1-10V DIM | 2545 Lm

#### On request:

3000K | UGR 19\* | 1-10V DIM | 2508 Lm  
 4000K | UGR 22 | 1-10V DIM | 2860 Lm  
 4000K | UGR 22 | DALI DIM | 2860 Lm  
 3000K | UGR 22 | DALI DIM | 2545 Lm

\* To achieve a UGR 19, the product is fitted with a Prismatic diffusor instead of a milky diffusor. LED dots will be visible.

### Polar Curve

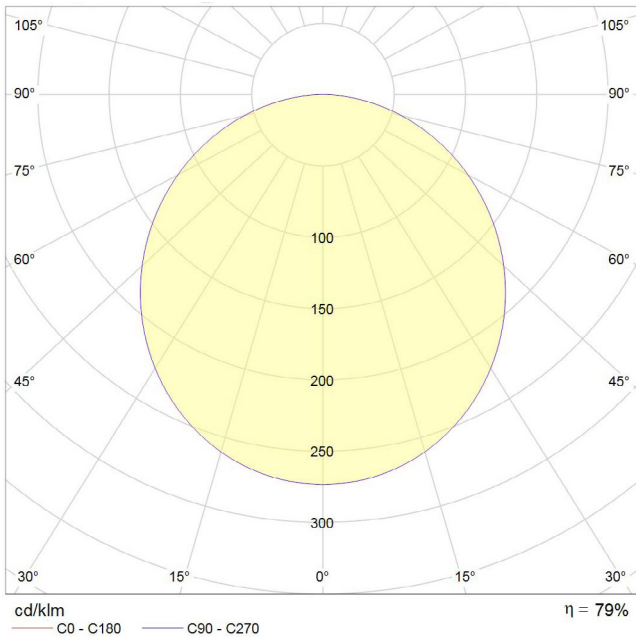

### Cone Diagram

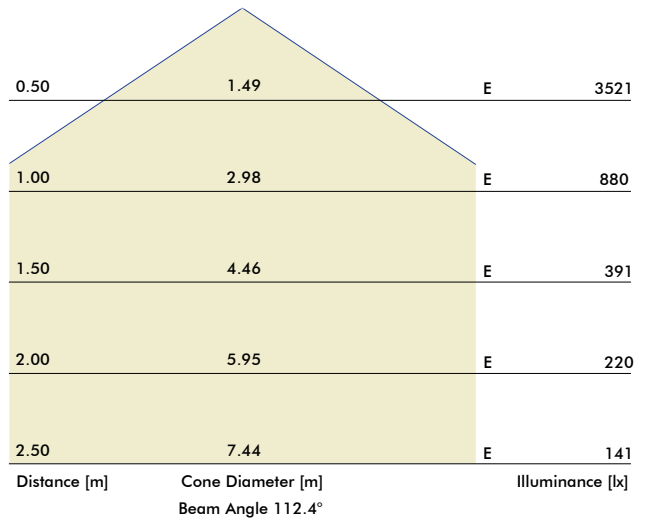

ref model: LED Disk 450 3000K UGR 22

# BuzziJet XXL

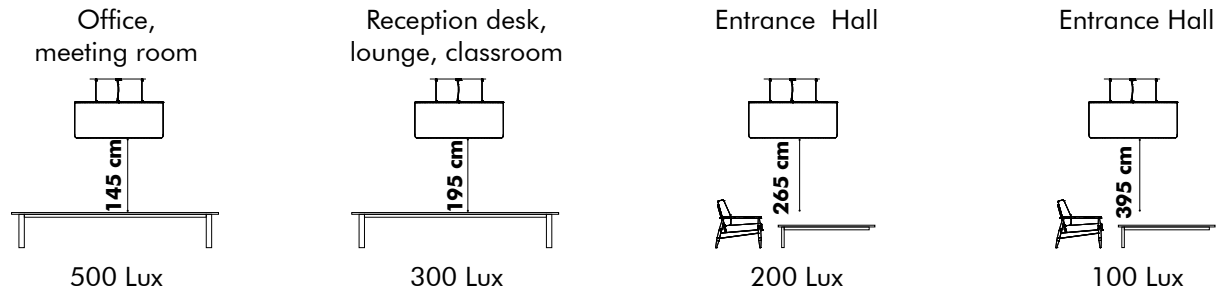

## Specification overview BuzziJet XXL

XXL: 3000K | UGR 23 | 1-10V DIM | 6232 Lm

### Polar Curve

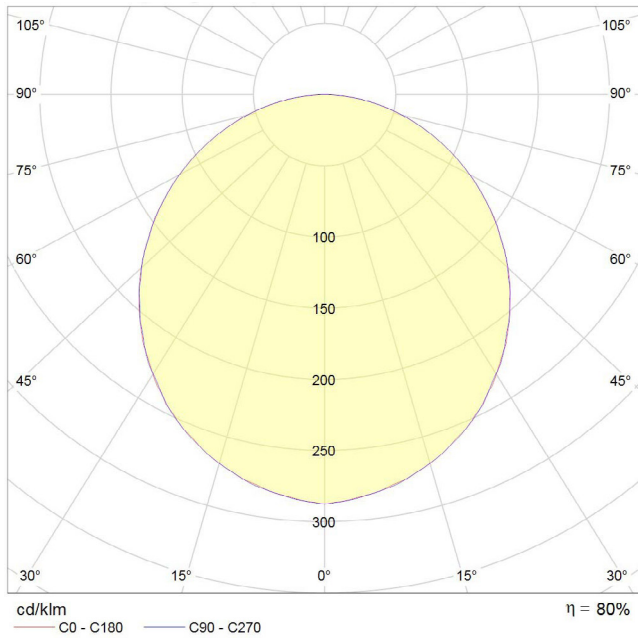

### Cone Diagram

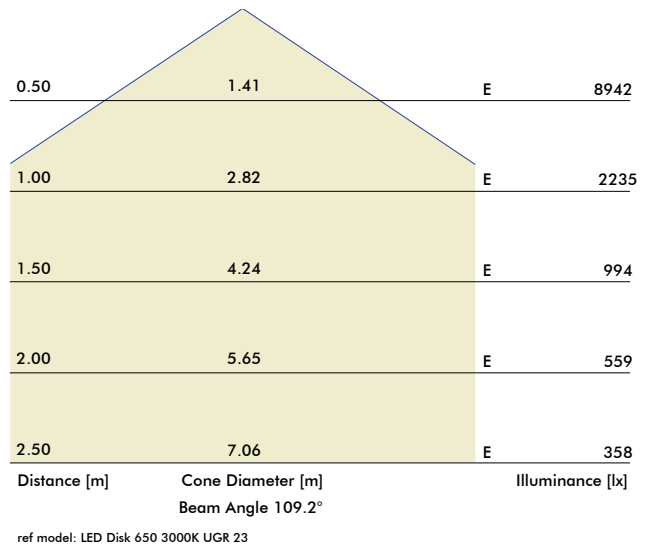



# Fabrics

## Fabric

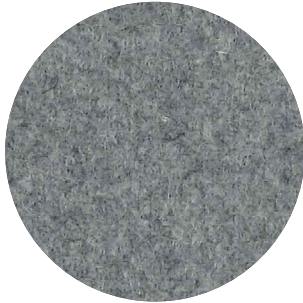

**Category A**

**Composition** 70% Recycled Wool, 25% Recycled Polyacryl,  
5% Recycled Other Fabrics

**Weight** 405 g/m<sup>2</sup> | 11.94 oz/yd<sup>2</sup>

**Abrasion resistance** 40.000 Martindale, 50,000 Wyzenbeek

**Flammability** EU: EN 1021.1/2006 | BS EN 1021.1/2006 (cigarette).  
EN 1021.2/2006 | BS EN 1021.2/2006 (match)  
USA: CAL TB 117 | ASTM E84 CLASS A

**Fastness to light** EU: 4 | USA 4

**Fastness to rubbing** EU: Wet 3-4 | Dry 4-5

**Fastness to crocking** USA: Wet 5 | Dry 5



## Trevira CS+ | CS

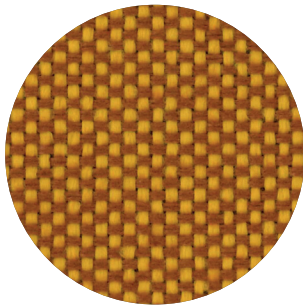

**Category A**

**Weight** 420 g/m<sup>2</sup> | 12.39 oz/yd<sup>2</sup>

**Composition** 100% Polyester, Trevira CS

**Abrasion resistance** 100.000 Martindale, 90,000 Wyzenbeek

**Flammability** BS 5852 part II: CRIB 5 | BS 7176 Medium Hazard  
USA: CAL TB 117 | M1 | B1 | EN 1021/1-2 | C1 |  
IMO Res. A652 (16)

**Fastness to light** EU: 6 | USA 5

**Fastness to rubbing** EU: Wet 4-5 | Dry 4-5

**Fastness to crocking** USA: Wet 5 | Dry 5



## Revive 1

kvadrat

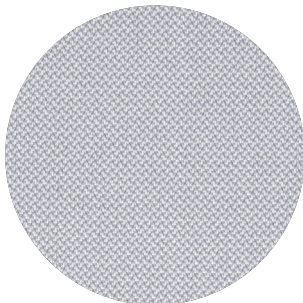

**Category A**

**Composition** 100% recycled polyester FR

**Weight** 430 g/lin.m

**Abrasion resistance** 60.000 Martindale rubs, EN ISO 12947

**Flammability** EN 1021-1/2 | DIN 4102 B1 | Önorm B1/Q1  
UNI 9175 1IM | US Cal. Tech. Bull. 117  
IMO A.652 (16)

**Fastness to light** Note 5-7, ISO 105-B02

**Fastness to rubbing** (ISO) dry 5, wet 4-5

**Pilling** Note 4-5, EN ISO 12945



## Clara 2

kvadrat

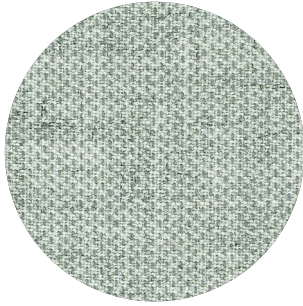

**Category B**

**Composition** 92% new wool, 8% nylon

**Weight** 400 g/lin.m

**Abrasion resistance** 80.000 Martindale rubs, EN ISO 12947

**Flammability** EN 1021-1/2 | BS 5852, ignition source 2-3 | DIN 4102 B2  
NF D 60 013 | UNI 9175 11M | US Cal. Tech. Bull. 117, Sec. E  
NFPA 260 | IMO A.652(16)

**Fastness to light** Note 5-7, ISO 105-B02

**Fastness to rubbing** (ISO) dry 4-5, wet 4

**Pilling** Note 4, EN ISO 12945



## Remix 3

kvadrat



**Category B**

**Composition** 90% new wool, 10% nylon

**Weight** 415 g/lin.m

**Abrasion resistance** 100.000 Martindale rubs, EN ISO 12947

**Flammability** EN 1021-1/2 | BS 5852 part 1  
Önorm B1/Q1 | NF D 60 013 | UNI 9175, 11M  
AS/NZS 1530.3 | Cal. Tech. Bull. 117-2013  
NFPA 260 | IMO FTP Code 2010:Part 8

**Fastness to light** Note 5-7, ISO 105-B02

**Fastness to rubbing** (ISO) dry 4-5, wet 4

**Pilling** Note 4, EN ISO 12945



## Hero

kvadrat

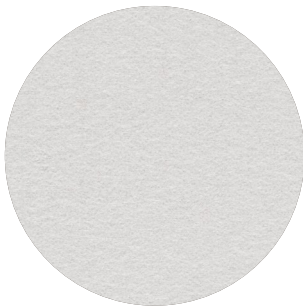

**Category C**

**Composition** 96% new wool, 4% nylon

**Weight** 580 g/lin.m

**Abrasion resistance** 45.000 Martindale rubs, EN ISO 12947

**Flammability** EN 1021-1/2 | DIN 4102 B2 | NF D 60 013  
UNI 9175 11M | US Cal. Bull. 117-2013 | NFPA 260  
IMO A.652 (16)

**Fastness to light** Note 5-6, ISO 105-B02

**Fastness to rubbing** (ISO) dry 4-5, wet 4-5

**Pilling** Note 3-4, EN ISO 12945



## Tonus 4

kvadrat



**Category D**

**Composition** 90% new wool, 10% Helanca

**Weight** 665 g/lin.m

**Abrasion resistance** 100.000 Martindale rubs, EN ISO 12947

**Flammability** EN 1021-1/2 | BS 5852 part 1 | DIN 4102 B2  
Önorm B1/Q1 | NF D 60 013 | UNI 9175 11M  
US Cal. Bull. 117-2013 | NFPA 260 | IMO A.652 (16)

**Fastness to light** Note 5-7, ISO 105-B02

**Fastness to rubbing** (ISO) dry 3-5, wet 3-5

**Pilling** Note 3, EN ISO 12945



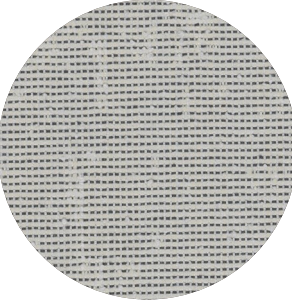

**Category** E

**Composition** 100% Trevira CS

**Weight** 700 g/lin.m

**Abrasion resistance**

35.000 rubs acc. to the Martindale method, EN ISO 12947

**Flammability** EN 1021-1/2 | DIN 4102 B1 | Önorm B1/Q1  
NF D 60 013 | NF P 92 507 M1 | UNI 9175 1IM  
UNI 9177 classe 1 | US Cal. Tech. Bull. 117  
IMO A.652 (16)

**Fastness to light** Note 5-8, ISO 105-B02

**Fastness to rubbing** (ISO) dry 4-5, wet 4-5

**Pilling** Note 4, EN ISO 12945



# Dimensions

## BuzziJet S

Straight

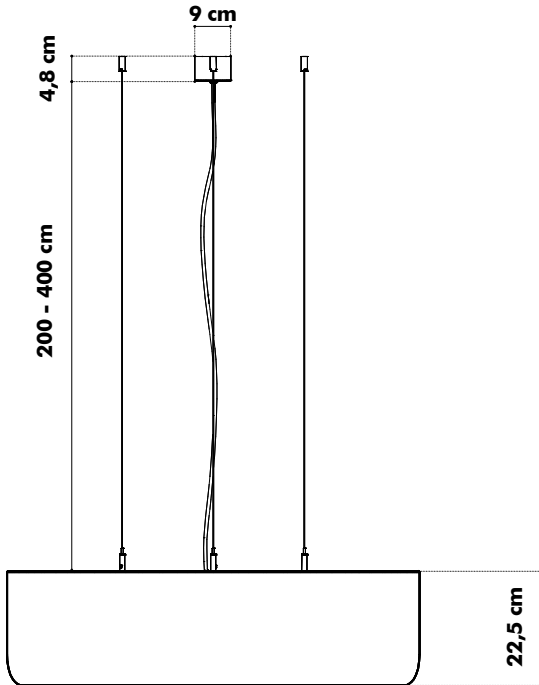

Split

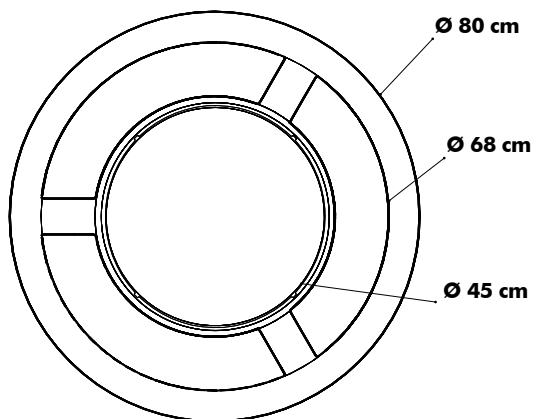
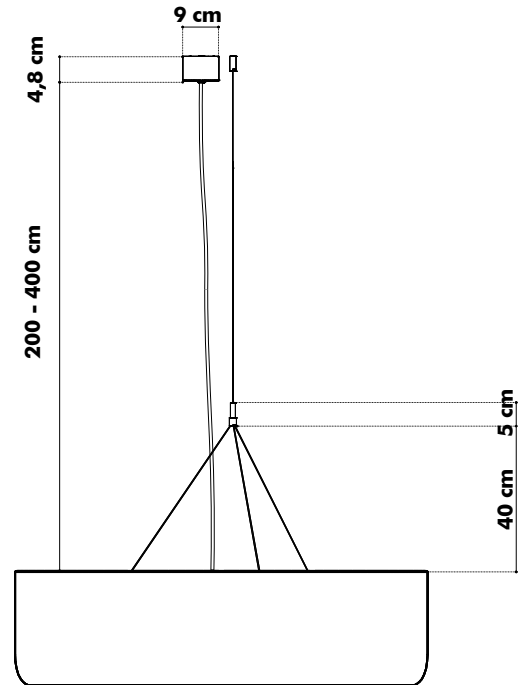

# BuzziJet M

## Straight

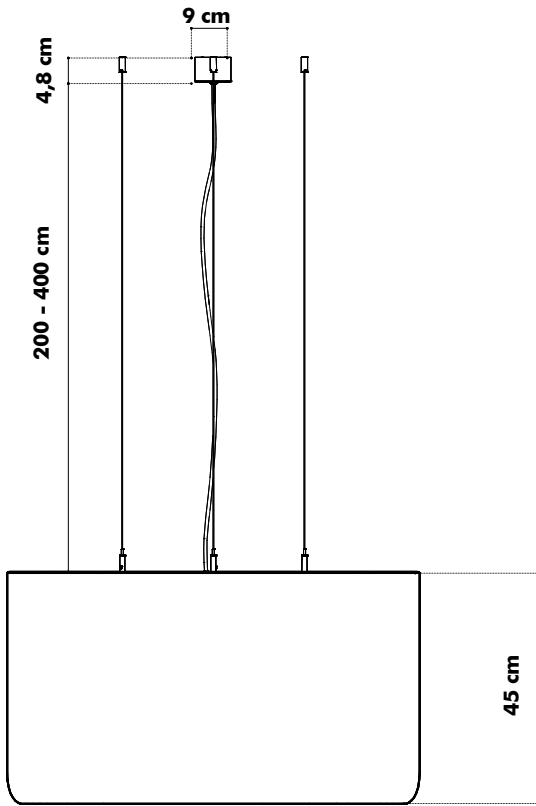

## Split

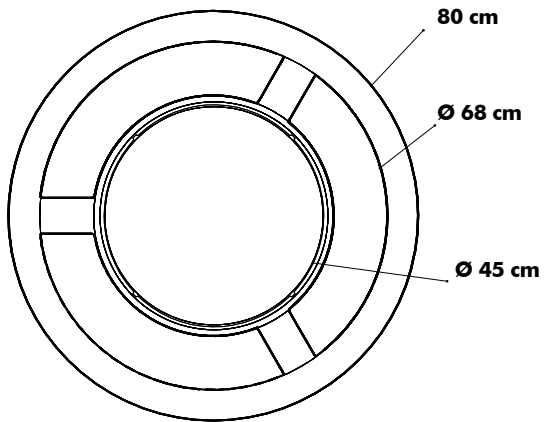
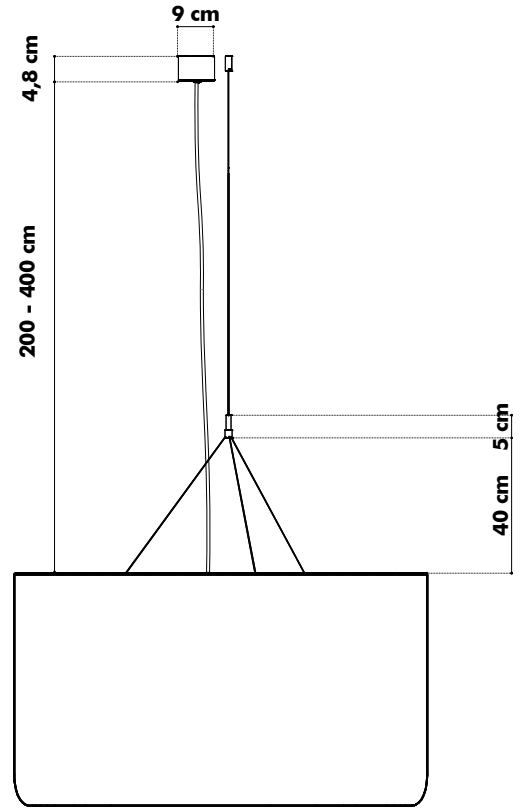

# BuzziJet XL

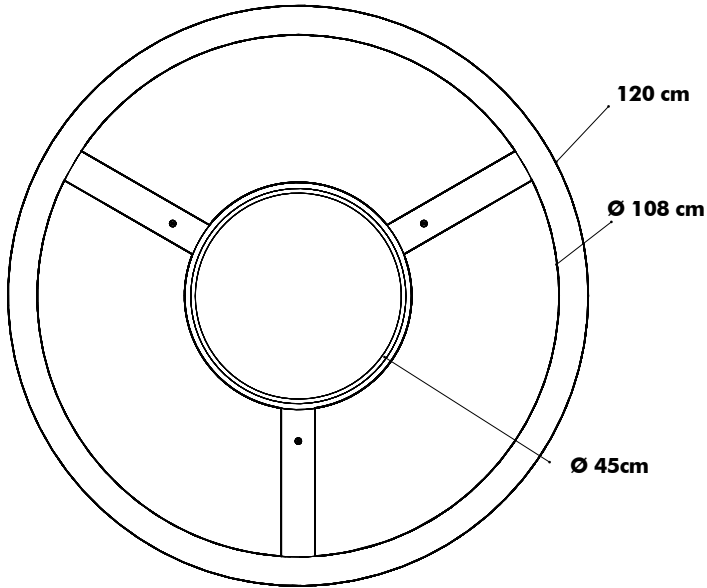
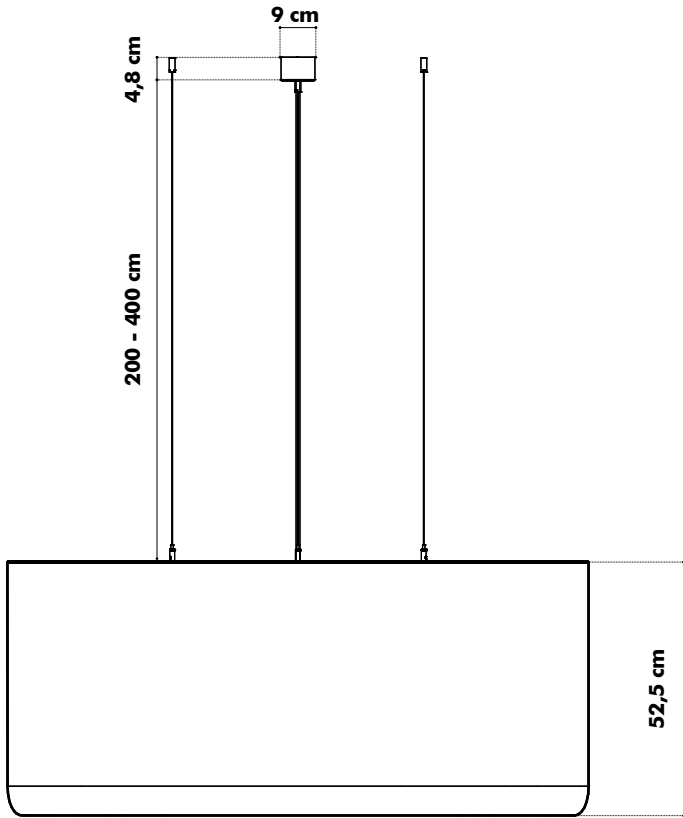

---

# BuzziJet XXL

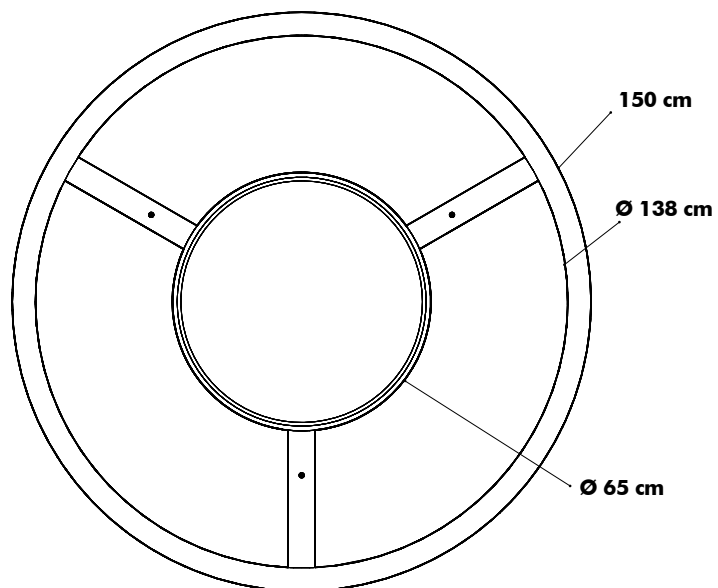
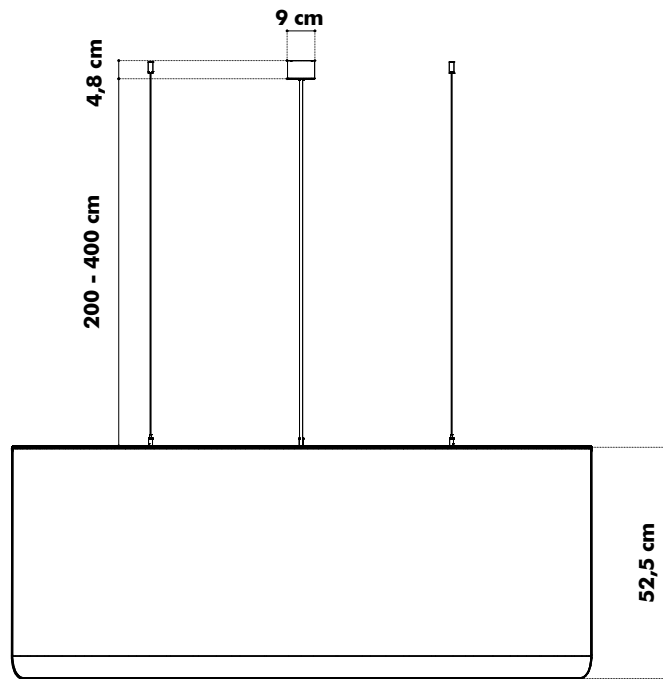

# Acoustics

## BuzziJet

Equivalent sound absorption area in m<sup>2</sup> per object

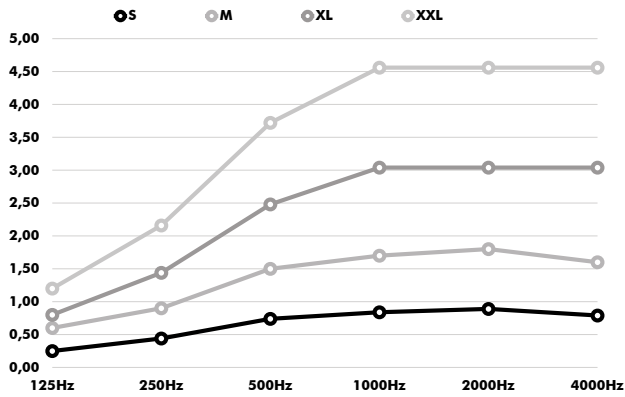

Hz	S Aeq/m <sup>2</sup>	M Aeq/m <sup>2</sup>	XL Aeq/m <sup>2</sup>	XXL Aeq/m <sup>2</sup>
125	0.25	0.60	0.80	1.20
250	0.44	0.90	1.44	2.16
500	0.74	1.50	2.48	3.72
1000	0.84	1.70	3.04	4.56
2000	0.89	1.80	3.04	4.56
4000	0.79	1.60	3.04	4.56





---

# BuzziJet

## Standing 220-240V

### Product Specification Sheet

---

This document contains technical information about the BuzziJet Standing



## Perfect Curve

BuzziJet Standing is a simple and stylish add-on to any lounge area or break-out zone. Designed with flexible and open spaces in mind, this sound-absorbing floor lamp brings personality to the space while offering a cosy and calm atmosphere. Its wide upholstered body and aerodynamic design, supported by an elegant curvy frame, will let you experience the importance of good acoustics. Moreover, create a warm and relaxed space through its dimming feature.

Designed by BuzziSpace Studio

---

## General

 Standing

Upholstered acoustic foam shade  
LED disk with opaque diffusor

 Aluminium arch in black (RAL 9005)  
Metal baseplate in black (RAL 9005)  
Fabric power cord in black or red

Wattage: 21W  
Input Voltage: 220-240V  
Input Frequency: 50/60Hz  
Lumen Output: 1900 lumen  
Color Temperature: 3000K  
Color Rendering Index: >95  
Dimming: Floordimmer  
Unified Glare Rating: 22



 IP20 Dry Usage

 Assembled

---

## Acoustics



Absorption



Diffusion



Low tone



Mid tone



High tone

---

## Certifications

CE/CB

---

## Content

Configurations	3	Dimensions	8
Technical components	4	Acoustics	9
Fabrics	5		

# Configurations

---

## BuzziJet Standing

- Upholstered acoustic foam shade
- LED disk with opaque diffusor
- 🌲 Aluminium arch in black (RAL 9005)
- Metal baseplate in black (RAL 9005)
- Fabric power cord in black or red
  
- Total:           Width 187 cm Heigh 211 cm
- ✂ Base:            Ø 65 cm Heigh  2 cm
- Acoustic Shade:  Ø 80 cm Heigh  30 cm
  
- ⚖ Baseplate:     45 kg
- Arch & Shade:  23 kg

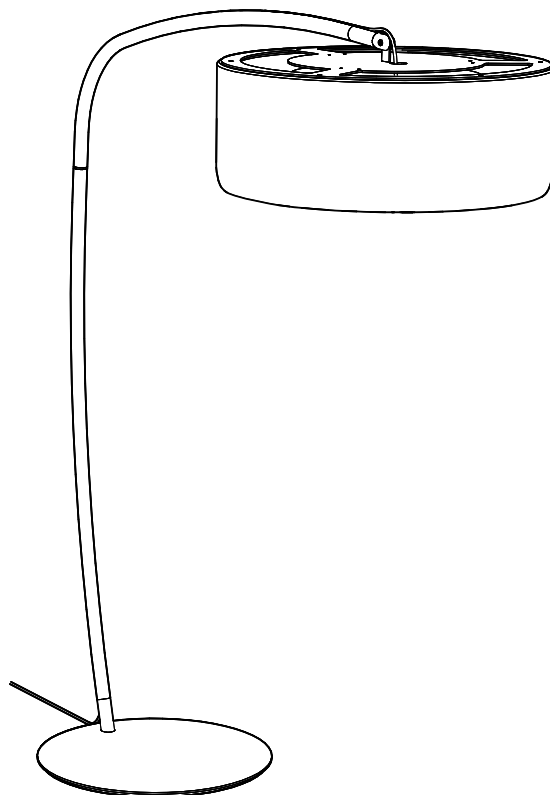

# Technical Components

---

## Light source



The Light source is wrapped with an upholstered ring in the same fabric as the foam shade. The PMMA diffuser ensures an optimal light spread and efficiency. It creates a very diffuse light surface without any dottiness. The light source of the BuzziJet Standing is a LED PCB, containing 36 low power LED's.

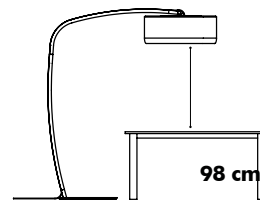

350 Lux

## All in details

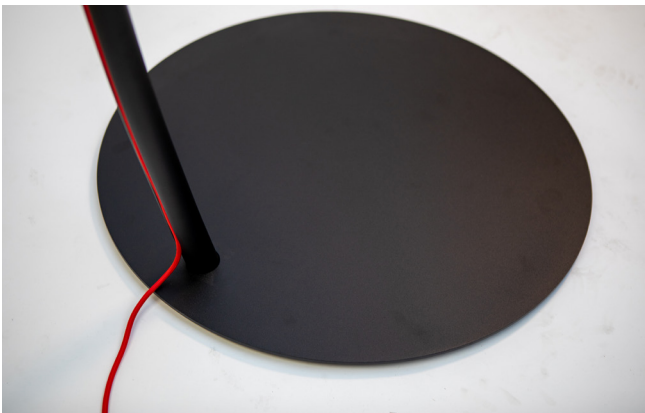

As final touch the fabric cable is intentionally pushed into the curved shape frame, hiding all the screws and connections. Select a red fabric power cable to create a detail that stands out or choose a black one to create an elegant layout.

## Dimming



You can choose from a more energized or intimate atmosphere by dimming the light and relax.

# Fabrics

## Fabric

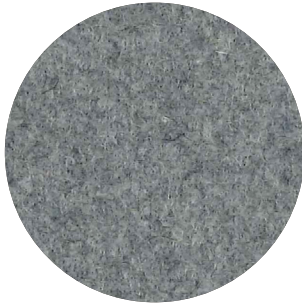

**Category** A

**Composition** 70% Recycled Wool, 25% Recycled Polyacryl,  
5% Recycled Other Fabrics

**Weight** 405 g/m<sup>2</sup> | 11.94 oz/yd<sup>2</sup>

**Abrasion resistance** 40.000 Martindale, 50,000 Wyzenbeek

**Flammability** EU: EN 1021.1/2006 | BS EN 1021.1/2006 (cigarette).  
EN 1021.2/2006 | BS EN 1021.2/2006 (match)  
USA: CAL TB 117 | ASTM E84 CLASS A

**Fastness to light** EU: 4 | USA 4

**Fastness to rubbing** EU: Wet 3-4 | Dry 4-5

**Fastness to crocking** USA: Wet 5 | Dry 5



## Trevira CS+ | CS

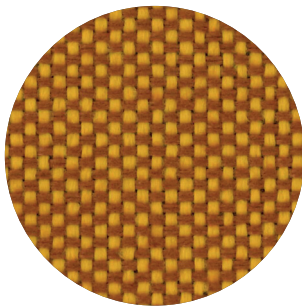

**Category** A

**Weight** 420 g/m<sup>2</sup> | 12.39 oz/yd<sup>2</sup>

**Composition** 100% Polyester, Trevira CS

**Abrasion resistance** 100.000 Martindale, 90,000 Wyzenbeek

**Flammability** BS 5852 part II: CRIB 5 | BS 7176 Medium Hazard  
USA: CAL TB 117 | M1 | B1 | EN 1021/1-2 | C1 |  
IMO Res. A652 (16)

**Fastness to light** EU: 6 | USA 5

**Fastness to rubbing** EU: Wet 4-5 | Dry 4-5

**Fastness to crocking** USA: Wet 5 | Dry 5



## Revive 1

kvadrat

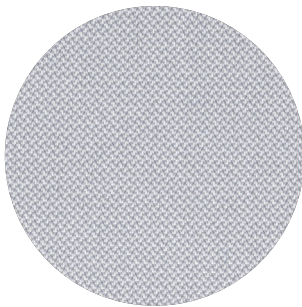

**Category** A

**Composition** 100% recycled polyester FR

**Weight** 430 g/lin.m

**Abrasion resistance** 60.000 Martindale rubs, EN ISO 12947

**Flammability** EN 1021-1/2 | DIN 4102 B1 | Önorm B1/Q1  
UNI 9175 1IM | US Cal. Tech. Bull. 117  
IMO A.652 (16)

**Fastness to light** Note 5-7, ISO 105-B02

**Fastness to rubbing** (ISO) dry 5, wet 4-5

**Pilling** Note 4-5, EN ISO 12945



## Clara 2

kvadrat

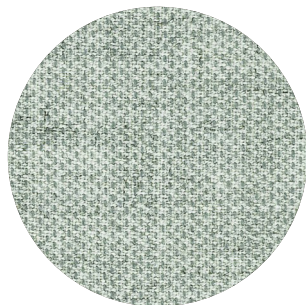

**Category** B

**Composition** 92% new wool, 8% nylon

**Weight** 400 g/lin.m

**Abrasion resistance** 80.000 Martindale rubs, EN ISO 12947

**Flammability** EN 1021-1/2 | BS 5852, ignition source 2-3 | DIN 4102 B2  
NF D 60 013 | UNI 9175 11M | US Cal. Tech. Bull. 117, Sec. E  
NFPA 260 | IMO A.652(16)

**Fastness to light** Note 5-7, ISO 105-B02

**Fastness to rubbing** (ISO) dry 4-5, wet 4

**Pilling** Note 4, EN ISO 12945



## Remix 3

kvadrat



**Category** B

**Composition** 90% new wool, 10% nylon

**Weight** 415 g/lin.m

**Abrasion resistance** 100.000 Martindale rubs, EN ISO 12947

**Flammability** EN 1021-1/2 | BS 5852 part 1  
Önorm B1/Q1 | NF D 60 013 | UNI 9175, 11M  
AS/NZS 1530.3 | Cal. Tech. Bull. 117-2013  
NFPA 260 | IMO FTP Code 2010:Part 8

**Fastness to light** Note 5-7, ISO 105-B02

**Fastness to rubbing** (ISO) dry 4-5, wet 4

**Pilling** Note 4, EN ISO 12945



## Hero

kvadrat

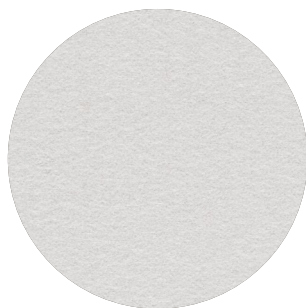

**Category** C

**Composition** 96% new wool, 4% nylon

**Weight** 580 g/lin.m

**Abrasion resistance** 45.000 Martindale rubs, EN ISO 12947

**Flammability** EN 1021-1/2 | DIN 4102 B2 | NF D 60 013  
UNI 9175 11M | US Cal. Bull. 117-2013 | NFPA 260  
IMO A.652 (16)

**Fastness to light** Note 5-6, ISO 105-B02

**Fastness to rubbing** (ISO) dry 4-5, wet 4-5

**Pilling** Note 3-4, EN ISO 12945



## Tonus 4

kvadrat

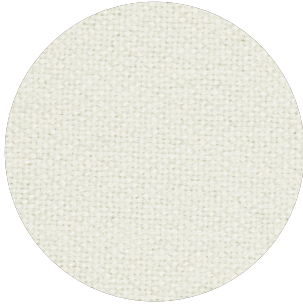

**Category** D

**Composition** 90% new wool, 10% Helanca

**Weight** 665 g/lin.m

**Abrasion resistance** 100.000 Martindale rubs, EN ISO 12947

**Flammability** EN 1021-1/2 | BS 5852 part 1 | DIN 4102 B2

Önorm B1/Q1 | NF D 60 013 | UNI 9175 11M

US Cal. Bull. 117-2013 | NFPA 260 | IMO A.652 (16)

**Fastness to light** Note 5-7, ISO 105-B02

**Fastness to rubbing** (ISO) dry 3-5, wet 3-5

**Pilling** Note 3, EN ISO 12945



## Memory 2

kvadrat

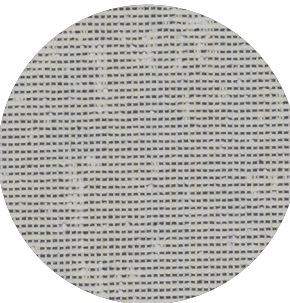

**Category** E

**Composition** 100% Trevira CS

**Weight** 700 g/lin.m

**Abrasion resistance**

35.000 rubs acc. to the Martindale method, EN ISO 12947

**Flammability** EN 1021-1/2 | DIN 4102 B1 | Önorm B1/Q1

NF D 60 013 | NF P 92 507 M1 | UNI 9175 11M

UNI 9177 classe 1 | US Cal. Tech. Bull. 117

IMO A.652 (16)

**Fastness to light** Note 5-8, ISO 105-B02

**Fastness to rubbing** (ISO) dry 4-5, wet 4-5

**Pilling** Note 4, EN ISO 12945



# Dimensions

## BuzziJet Standing

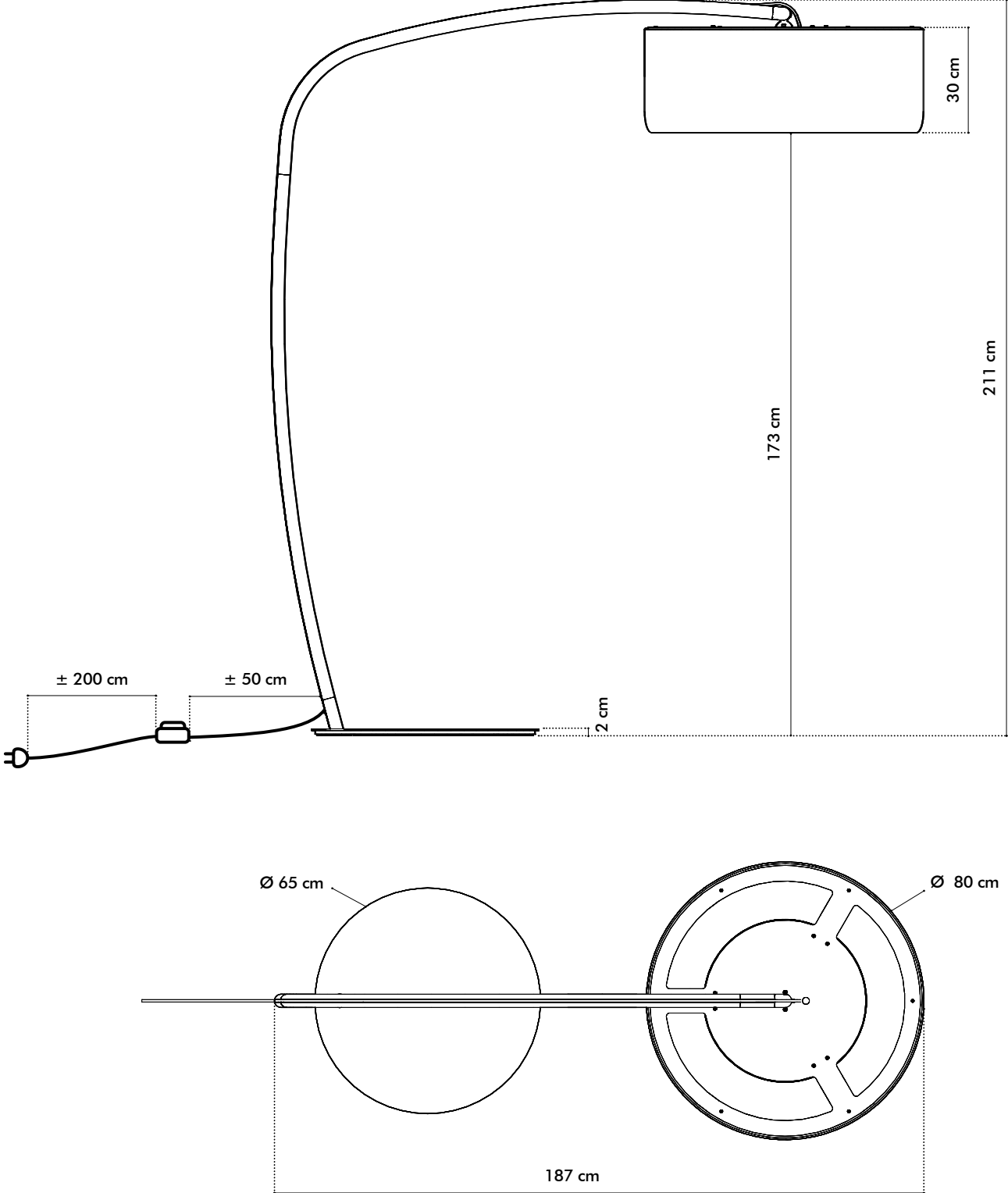



# Acoustics

---

## BuzziJet Standing

Equivalent sound absorption area in m<sup>2</sup> per object

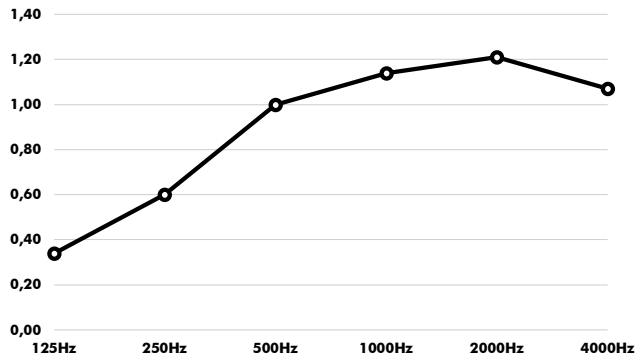

Hz	Aeq/m <sup>2</sup>
125	0.34
250	0.60
500	1.00
1000	1.14
2000	1.21
4000	1.07