

---

# BuzziFalls

## Product Specification Sheet

---

Discover all insights on BuzziFalls.  
Acoustical room dividers offering you a  
variety of patterns, sizes and colors to  
organize your space.

---





# A playful solution to regulate sounds

To divide a space and create some privacy, the BuzziFalls are a new playful variation in our acoustic solutions gamma. These strips are made out of BuzziFelt with cut-out shapes in various patterns, for example falling leaves. A playful solution to regulate sounds and create smaller areas in big spaces.

Design by Sas Adriaenssens

---

## General

-  Pattern: Alhambra, Birch, Cubes, Dots, Grid, Leaves, Orient, Palms, Parrots, Pebbles, Plain, Rain, Squares, Stars, Royal, Tropics  
Skylines: Atlanta, Chicago, London, Paris, New York, San Francisco (set of 3 panels)  
Monocolor | Bicolor
-  2 layers of BuzziFelt  
Profile metal powdercoated black | RAL 9005 matte or metal powdercoated White | RAL 9010 matte  
Pendant black steel cable for black profile | alu steel cable for white profile
-  Pattern: W 80 cm H 220 or 250 cm D 1 cm  
W 31.50" H 86.61 or 98.42" D 0.40"  
Skylines: W 80 cm H 100, 150, 220 or 250 cm D 1 cm  
W 31.50" H 39.37, 59.05, 86.61 or 98.42" D 0.40"
-  BuzziFall Wall | Ceiling mounted or BuzziFall Suspended  
Cable L 2 or 5 m, Ø 1,5 mm  
L 78.74 or 196.85", Ø 0.06"  
Possibility to connect several BuzziFalls  
Rail (1 | 2 | 3 falls in 1 rail)  
Extra rail for extension

---

## Acoustics



Absorption



Diffusion



Attenuation



High tone

---

## Content

Fabrics	3
Patterns	4
Fixing systems	9
Option Rail	13
Dimensions	14
Acoustics	16

# Fabrics

---

## Felt

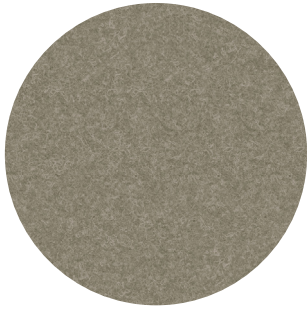

**Composition** 100% Recycled P.E.T. Felt, latex backing  
**Weight** 1.000 g/m<sup>2</sup> | 29.49 oz/yd<sup>2</sup>  
**Abrasion resistance** >7.000 Martindale  
**Flammability** EU: EN 13501.1 + A1/2009 Class B-s1,d0  
USA: ASTM E84 Class A certified  
**Fastness to light** USA 5



---

## Felt Printed\*



Concrete

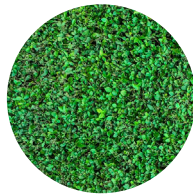

Green 1



Green 2



Jungle

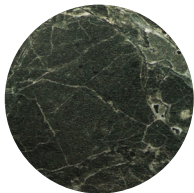

Marble Absynth

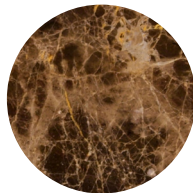

Marble Emperador



Camo Amazon



Camo Taiga



Camo Desert



Camo Snow

\*Technical Specification same as Felt



# Patterns

## Alhambra

250 cm 98.42"  
3,1 kg 6.83 lbs

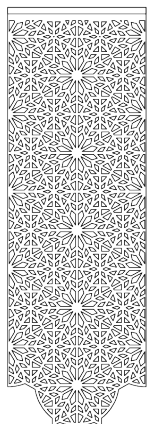

## Birch

220 cm 86.61"  
2,8 kg 6.17 lbs



## Cubes

250 cm 98.42"  
3,9 kg 8.71 lbs

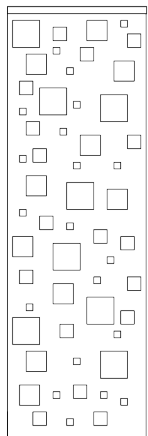

## Dots

250 cm 8.42"  
4,6 kg 10.14 lbs

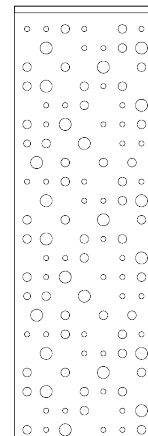

## Grid

250 cm 8.42"  
3 kg 6.61 lbs

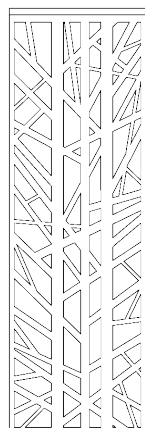

## Leaves

220 cm 86.61"  
2,6 kg 5.73 lbs

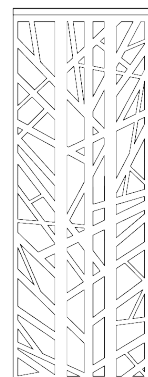

## Orient

250 cm 8.42"  
3,7 kg 8.16 lbs



## Palms

250 cm 8.42"  
4,3 kg 9.48 lbs

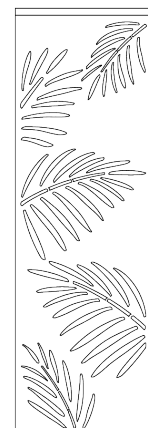

**Parrots**

**250 cm 8.42"**  
**3,6 kg 7.94 lbs**

**220 cm 86.61"**  
**3,2 kg 7.05 lbs**

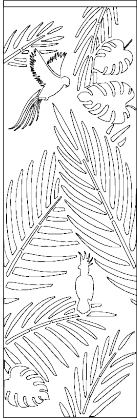

**Pebbles**

**250 cm 98.42"**  
**2 kg 4.41 lbs**

**220 cm 86.61"**  
**1.8 kg 3.97 lbs**

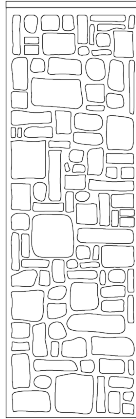

**Plain**

**250 cm 98.42"**  
**5,2 kg 11.46 lbs**

**220 cm 86.61"**  
**4,5 kg 9.92 lbs**



**Rain**

**250 cm 98.42"**  
**3,9 kg 8.60 lbs**

**220 cm 86.61"**  
**3,4 kg 7.50 lbs**

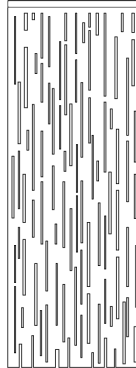
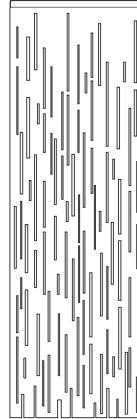

**Royal**

**250 cm 98.42"**  
**3,6 kg 8.00 lbs**

**220 cm 86.61"**  
**3,2 kg 7.05 lbs**



**Squares**

**250 cm 98.42"**  
**4,3 kg 9.41 lbs**

**220 cm 86.61"**  
**3,8 kg 8.33 lbs**

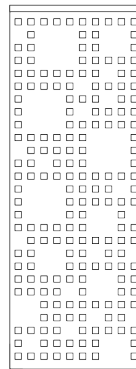
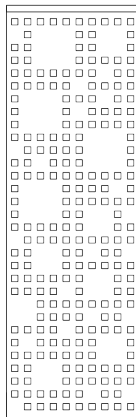

**Stars**

**250 cm 98.42"**  
**4,9 kg 10.87 lbs**

**220 cm 86.61"**  
**4,3 kg 9.57 lbs**

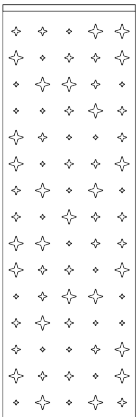

**Tropics**

**250 cm 98.42"**  
**3,1 kg 6.83 lbs**

**220 cm 86.61"**  
**2,7 kg 5.95 lbs**

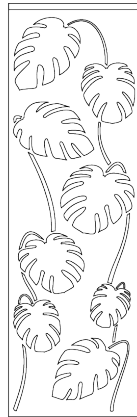

# Skylines

## New York

250 cm 98.42"

4,2 kg 9.26 lbs 4,0 kg 8.80 lbs 4,0 kg 8.80 lbs

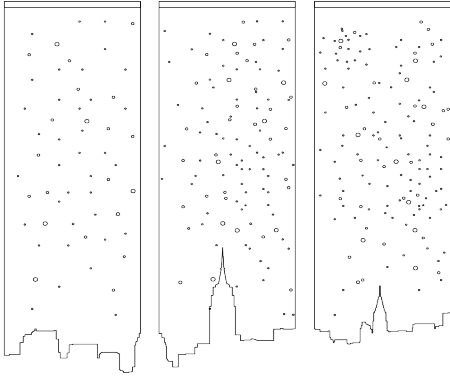

150 cm 59.05"

2,5 kg 5.59 lbs 2,3 kg 5.15 lbs 2,3 kg 5.15 lbs

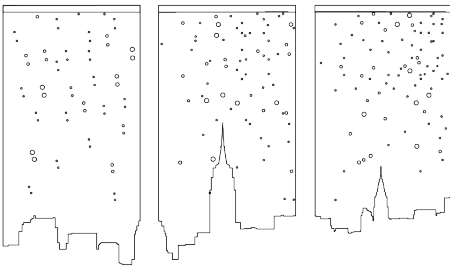

220 cm 86.61"

3,7 kg 8.1 lbs 3,5 kg 7.71 lbs 3,5 kg 7.71 lbs

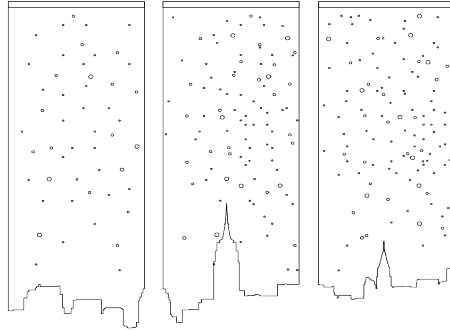

100 cm 39.37"

1,7 kg 3.76 lbs 1,5 kg 3.32 lbs 1,5 kg 3.32 lbs

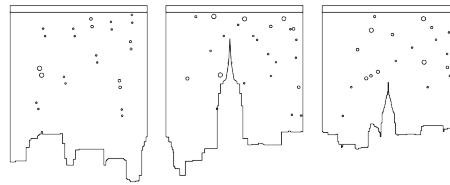

## Chicago

250 cm 98.42"

4,2 kg 9.26 lbs 3,9 kg 8.60 lbs 4,1 kg 9.03 lbs

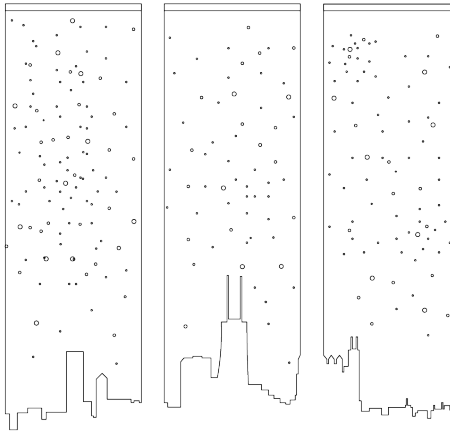

150 cm 59.05"

2,5 kg 5.59 lbs 2,2 kg 4.93 lbs 2,4 kg 5.37 lbs

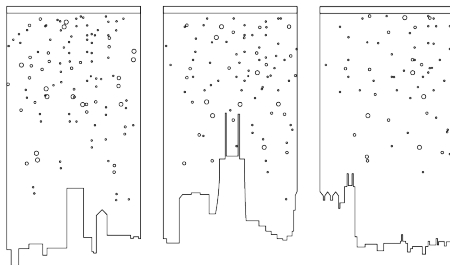

220 cm 86.61"

3,9 kg 8.60 lbs 3,5 kg 7.71 lbs 3,6 kg 8.16 lbs

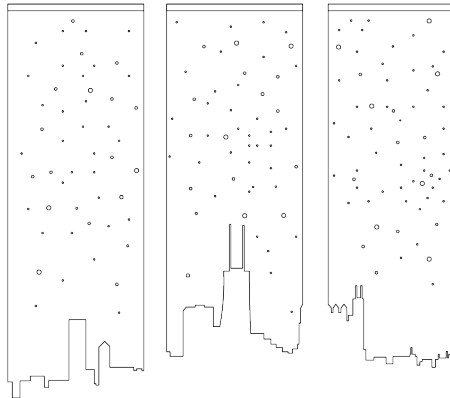

100 cm 39.37"

1,7 kg 3.76 lbs 1,4 kg 3.10 lbs 1,6 kg 3.54 lbs

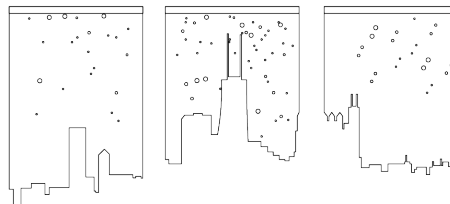

## Atlanta

**250 cm 98.42"**  
**4,3 kg 9.47 lbs 4,1 kg 9.03 lbs 4,0 kg 8.81lbs**

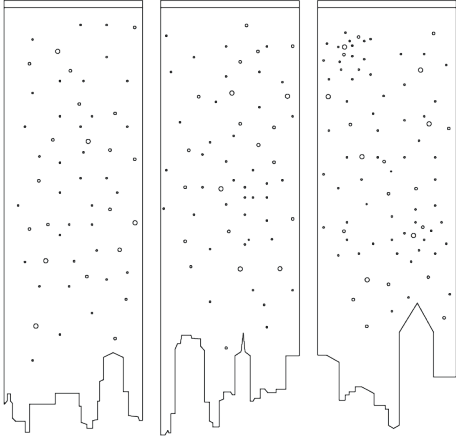

**220 cm 86.61"**  
**3,8 kg 8.37 lbs 3,6 kg 8.16 lbs 3,5 kg 7.71 lbs**

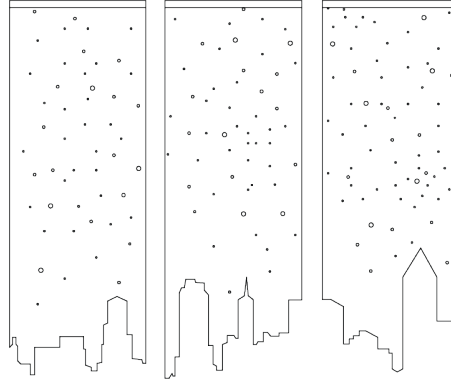

**150 cm 59.05"**  
**2,6 kg 5.82 lbs 2,5 kg 5.59 lbs 2,4 kg 5.37 lbs**

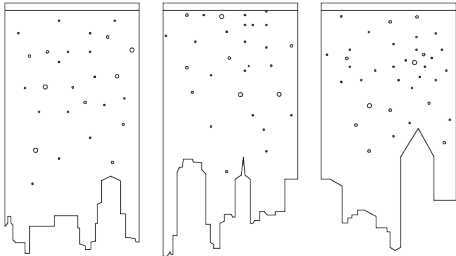

**100 cm 39.37"**  
**1,7 kg 3.76 lbs 1,6 kg 3.54 lbs 1,6 kg 3.54 lbs**

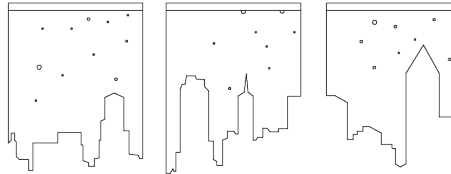

## San Francisco

**250 cm 98.42"**  
**4,3 kg 9.47 lbs 4,2 kg 9.25 lbs 4 kg 8.81 lbs**

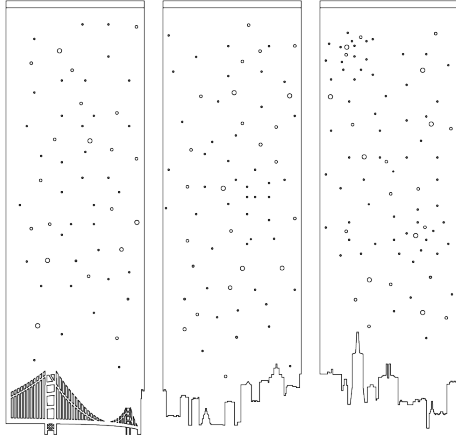

**220 cm 86.61"**  
**3,9 kg 8.59 lbs 3,7 kg 8.15 lbs 3,5kg 7.71 lbs**

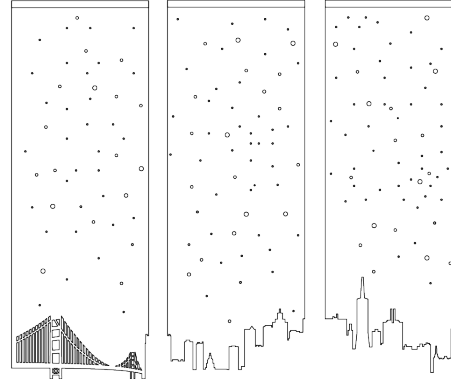

**150 cm 59.05"**  
**2,6 kg 5.82 lbs 2,5 kg 5.59 lbs 2,3 kg 5.15 lbs**

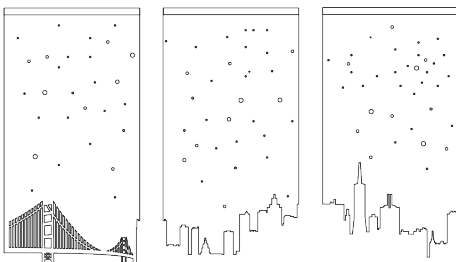

**100 cm 39.37"**  
**1,8 kg 3.99 lbs 1,7 kg 3.76 lbs 1,51 kg 3.32 lbs**

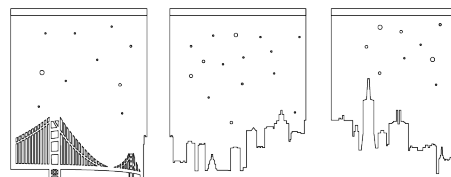

## London

250 cm 98.42"

4,2 kg 9.25 lbs 4,2 kg 9.25 lbs 4,3 kg 9.47 lbs

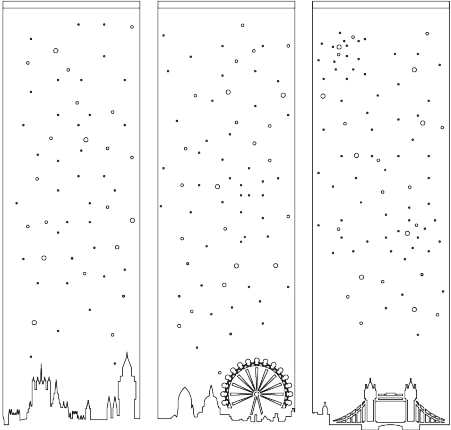

220 cm 86.61"

3,7 kg 8.15 lbs 3,7 kg 8.15 lbs 3,8 kg 8.37 lbs

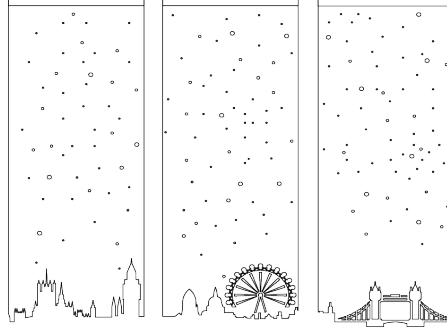

150 cm 59.05"

2,5 kg 5.59 lbs 2,5 kg 5.59 lbs 2,6 kg 5.82 lbs

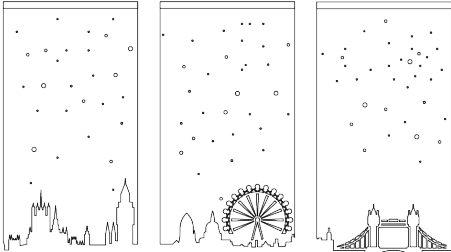

100 cm 39.37"

1,7 kg 3.76 lbs 1,7 kg 3.76 lbs 1,8 kg 3.99 lbs

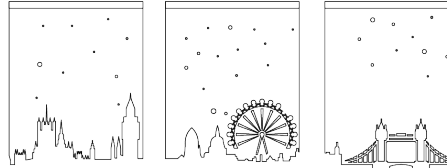

## Paris

250 cm 98.42"

4,4 kg 9.70 lbs 4,2 kg 9.25 lbs 4,2 kg 9.25 lbs

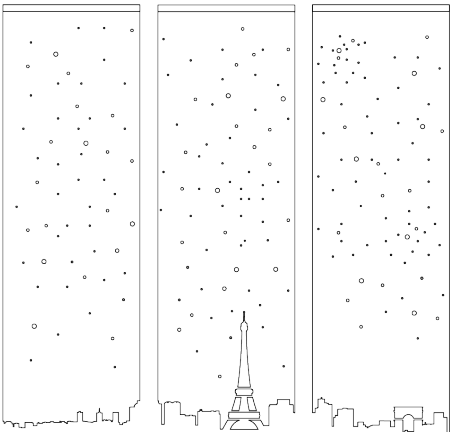

220 cm 86.61"

3,9 kg 8.59 lbs 3,8 kg 8.37 lbs 3,8 kg 8.37 lbs

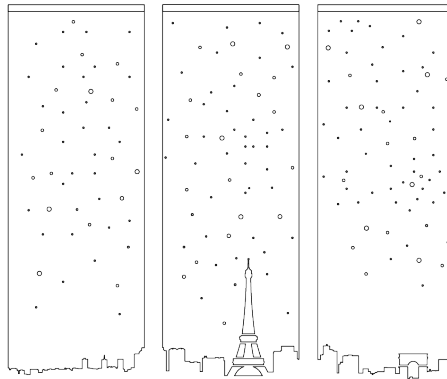

150 cm 59.05"

2,7 kg 6.04 lbs 2,5 kg 5.59 lbs 2,5 kg 5.59 lbs

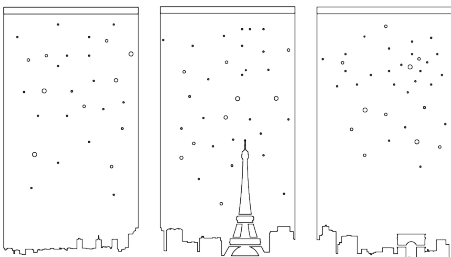

100 cm 39.37"

1,9 kg 4.21 lbs 1,7 kg 3.76 lbs 1,7 kg 3.76 lbs

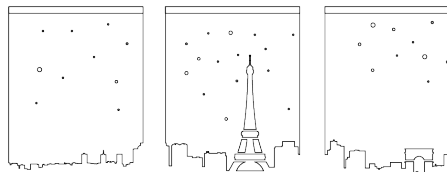



# Fixing Systems

## BuzziFalls Suspended

## BuzziFalls Suspended > 1

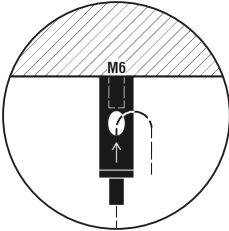
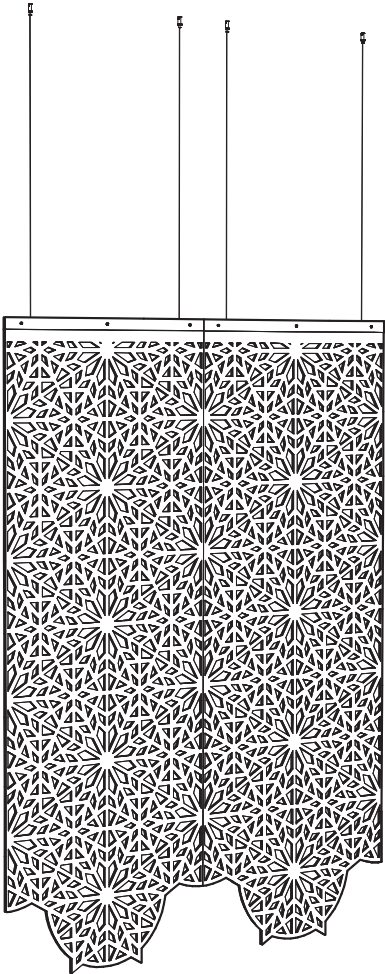
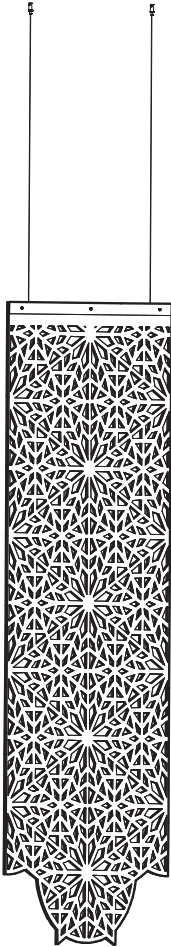

Profile black or white

2 cables per set, incl. fastner  
(stair bolts M6)

Black or alu colored cable  
L 200 or 500 cm, Ø 1,5 mm  
L 78.74" or 196.85", Ø 0.06"

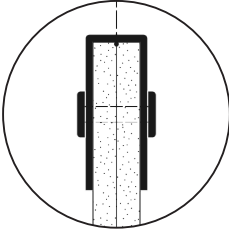

---

**BuzziFalls Ceiling Mounted**

---

**BuzziFalls Ceiling Mounted > 1**

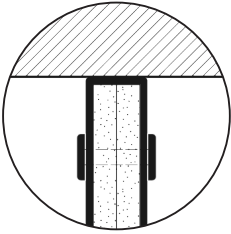
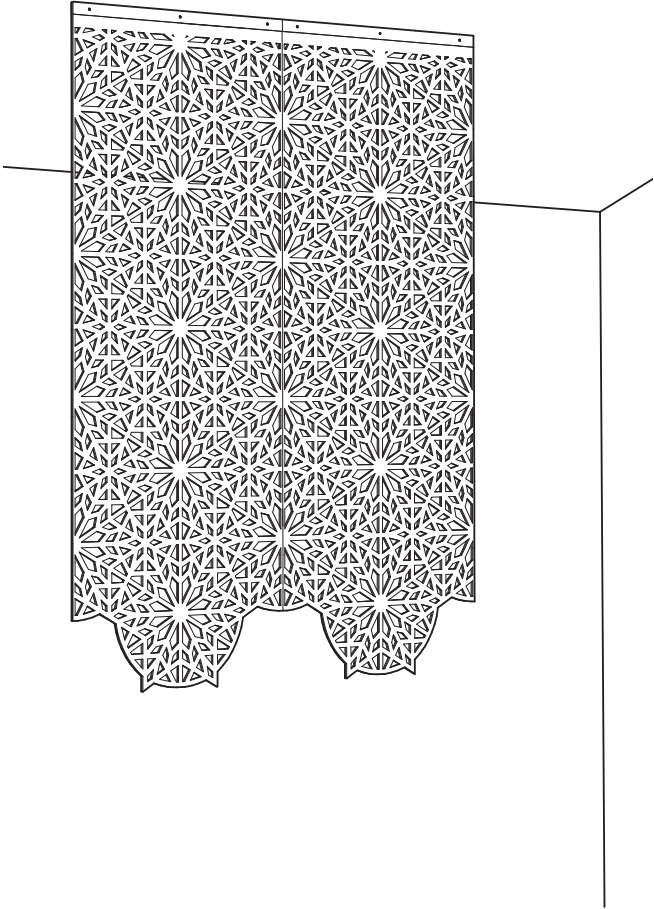
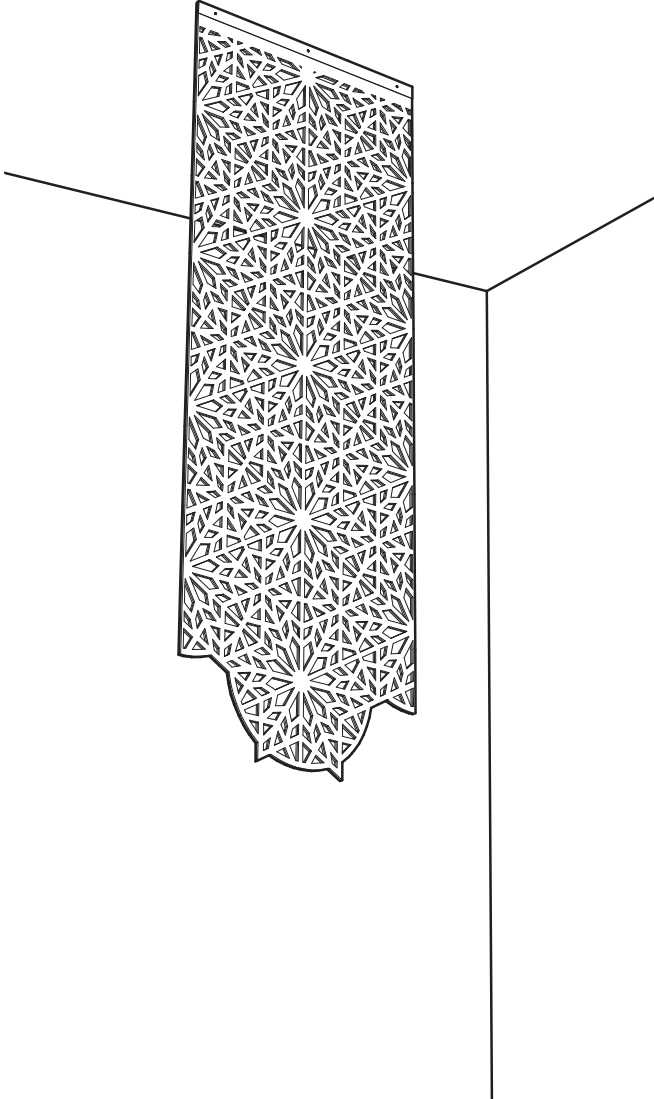

Profile black or white

---

## BuzziFalls Wall Mounted

---

## BuzziFalls Wall Mounted >1

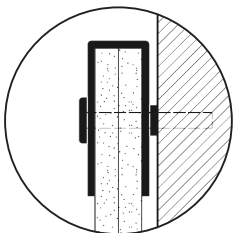
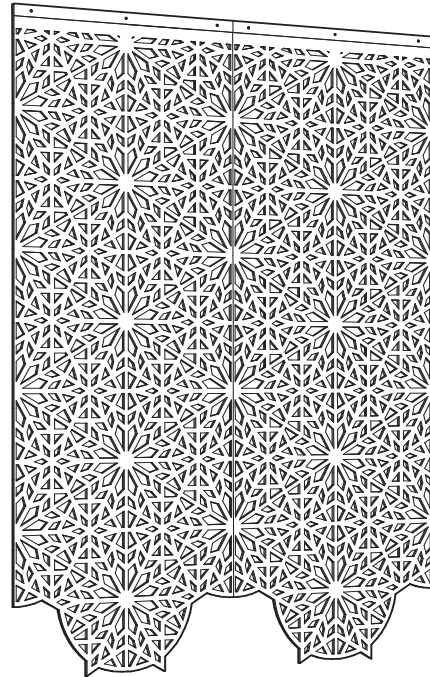
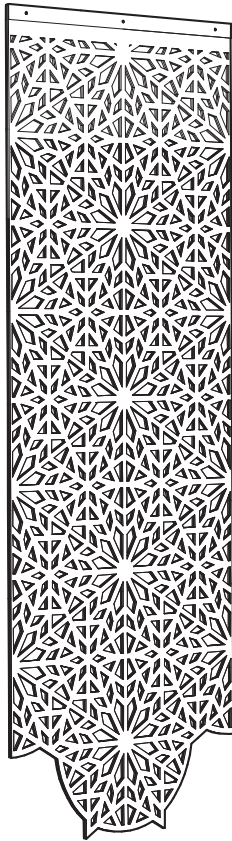

Profile black or white

3 screws 4x60 mm per set

3 cover caps per set, black or white, depending on color of profile

6 distance holders: 3 x 3 mm and 3 x 7,5 mm per set

---

## BuzziFalls Rail Suspended

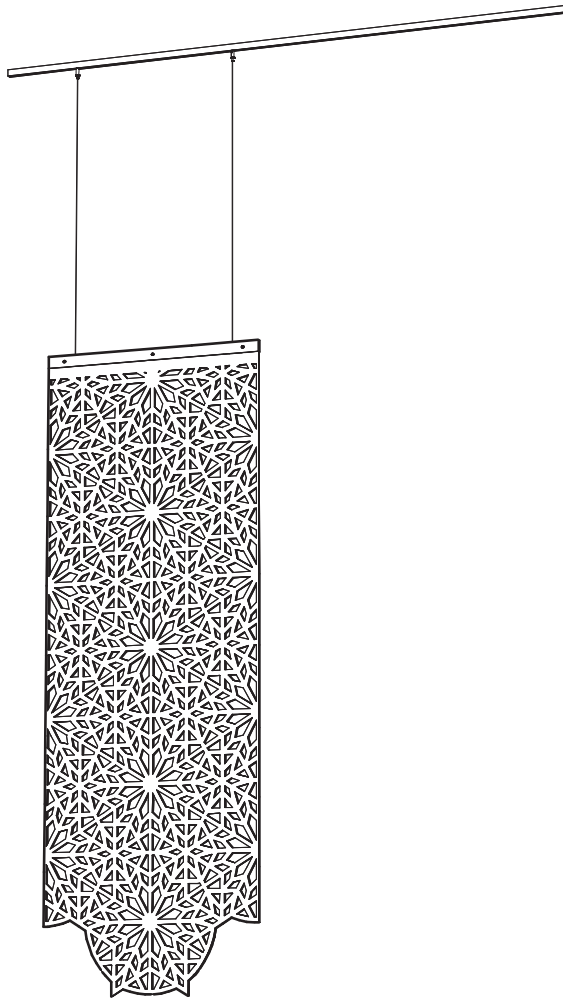

---

## BuzziFalls Rail Mounted

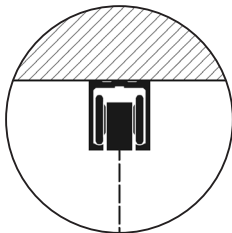
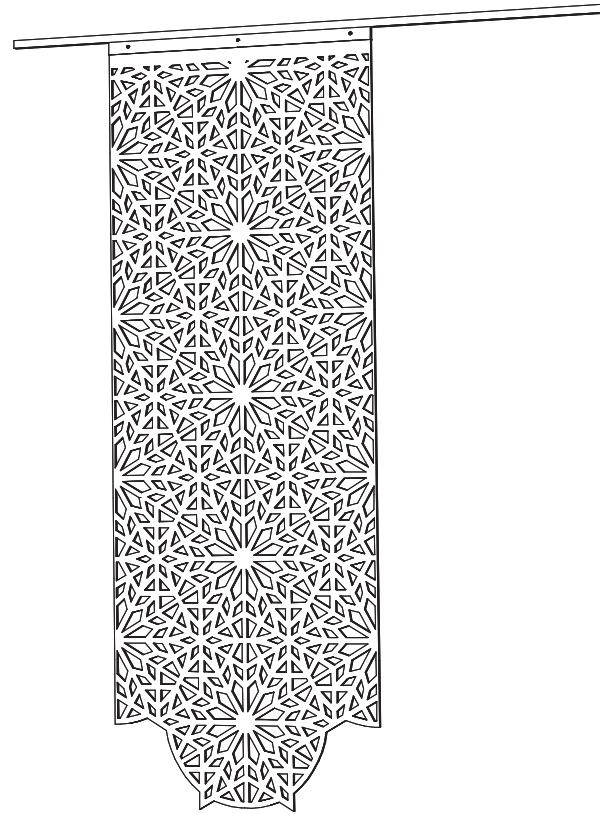

Rail black or white  
L: 3,20 m | 125.98"

Profile black or white

Black or alu colored cable  
L 200 or 500 cm,  
Ø 1,5 mm  
L 78.74" or 196.85",  
Ø 0.06"

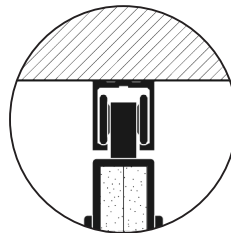
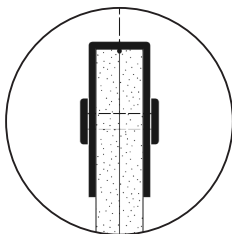

Rail black or white  
L 3,20 m | 125.98"

Profile black or white

# Option: Rail

The rail can be extended by buying a extra rail

---

## BuzziFalls Rail Suspended

Profile black or white

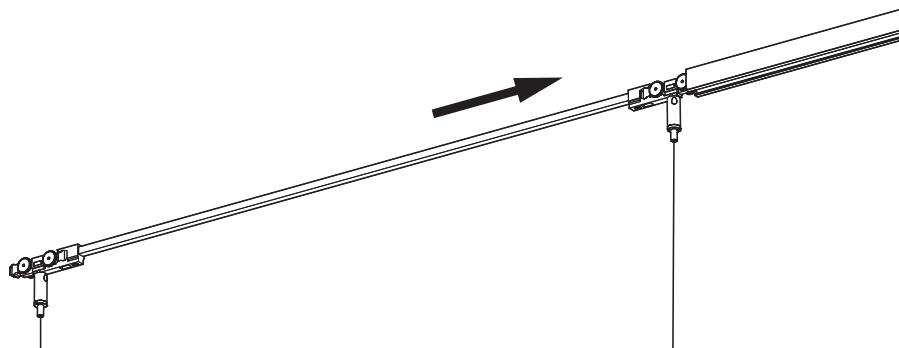

---

## BuzziFalls Rail Mounted

Profile black or white

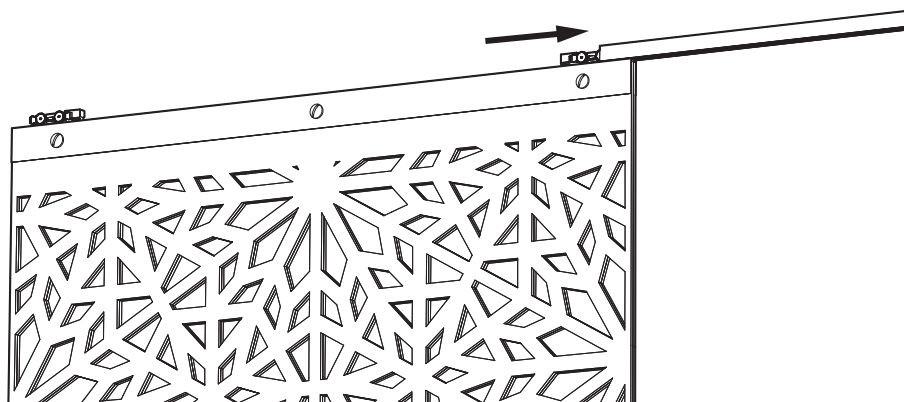

---

## Rail

Black or white, L 3,20 m | 125.98".

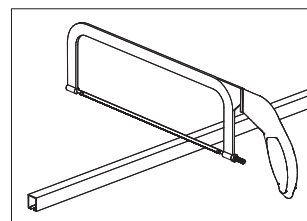
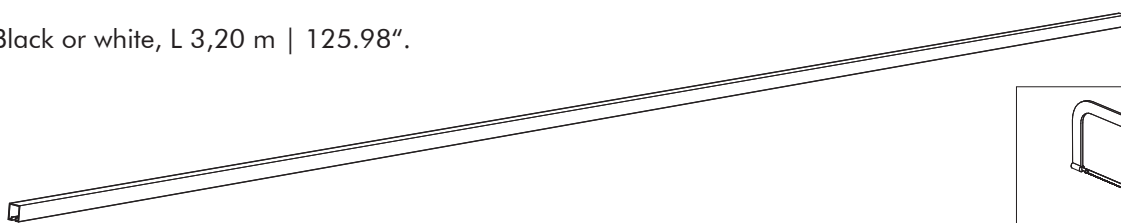

---

## End cap

End cap black or white included

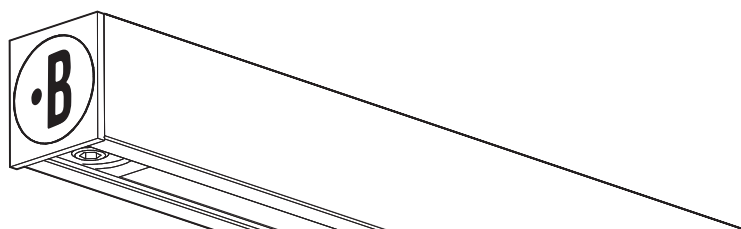



# Dimensions

## Falls Felt

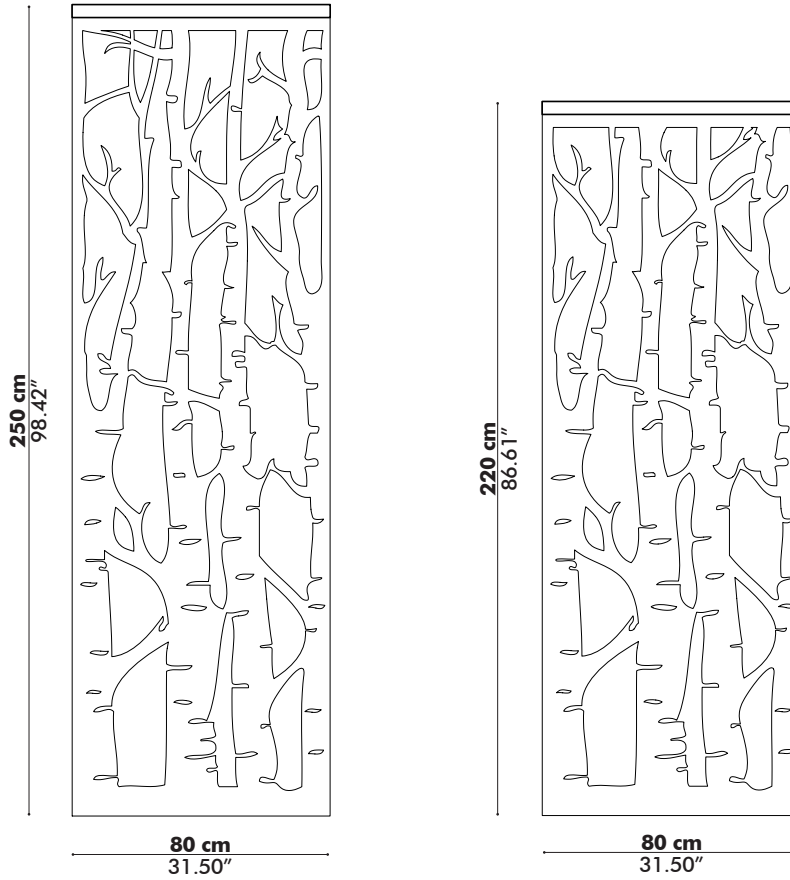

## Metal Profile

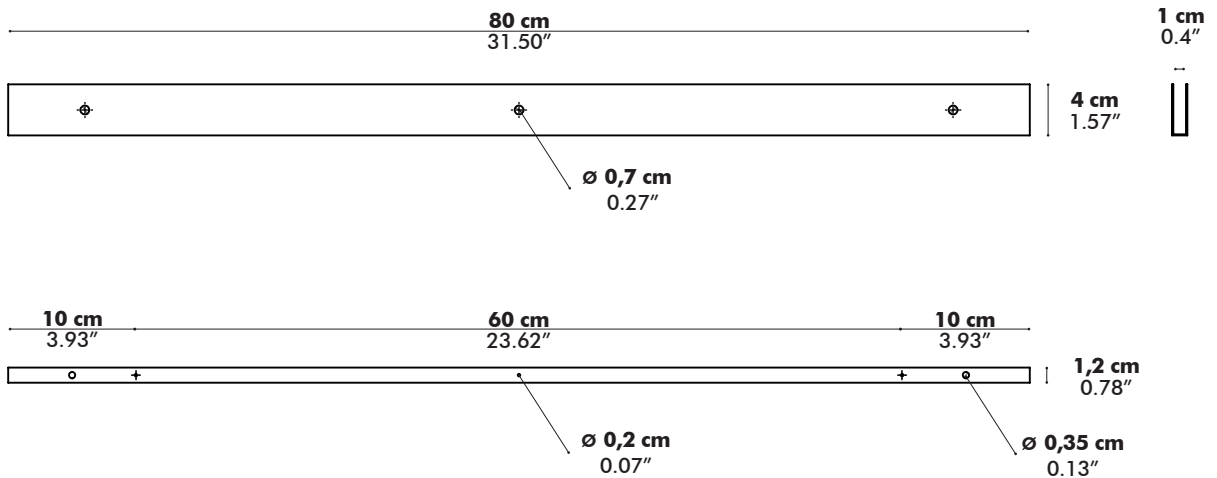

500 gr | 1.10 lbs

# Alu Rail

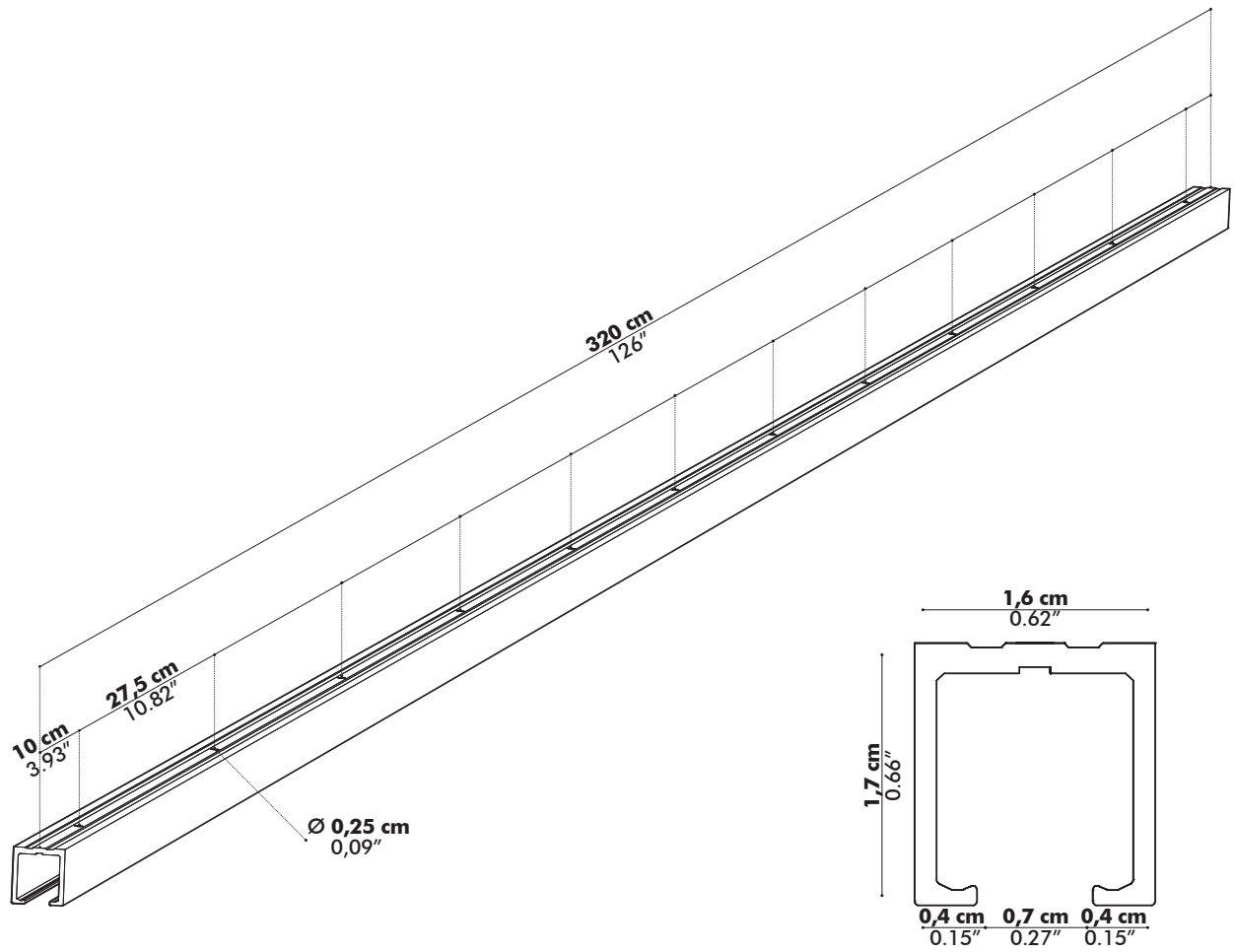

# Acoustics

## BuzziFalls Alhambra | Birch | Plain

Equivalent sound absorption area in m<sup>2</sup> per object

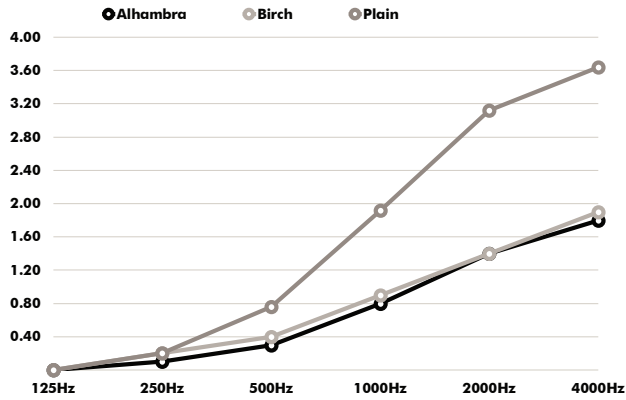

Hz	Alhambra Aeq/m <sup>2</sup>	Birch Aeq/m <sup>2</sup>	Plain Aeq/m <sup>2</sup>
125	0.00	0.00	0.04
250	0.10	0.20	0.20
500	0.30	0.40	0.76
1000	0.80	0.90	1.92
2000	1.40	1.40	3.12
4000	1.80	1.90	3.64