

---

# BuzziPlanter

## Product Specification Sheet

---

This document contains technical information about the BuzziPlanter

---

·BUZZI  
SPACE



## BuzziPlanter divides open spaces into green, silent microenvironments.





Built with a thick layer of high-density foam and finished off with a layer of fabric, it helps absorb excessive sound, thus creating calm, peaceful areas where it's nice to sit, gather, work and relax.

BuzziPlanter comes in 6 sizes. The bigger, the more sound-absorbing. The pots have a built-in plastic container, making it suitable for both real and artificial plants. Thanks to a wide variety of colors it easily fits any decor.

Design by BuzziSpace Studio

---

## General

-  BuzziPlanter 45 | 45 Long | 80
-  Filling: Acoustic foam + Plywood, MDF
-  Dry use
-  Free standing

---

## Acoustics



Absorption



Diffusion



Low tone



Mid tone



High tone

---

## Content

Configurations	3
Components	4
Fabrics	5
Dimensions	8
Acoustics	11

# Configurations

---

## BuzziPlanter 45

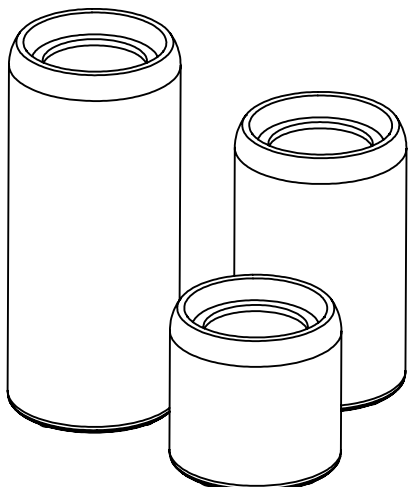

📏 S | M | L

🌲 Filling: Acoustic foam + Plywood, MDF  
Baseplate: Black MDF with plastic Feet

✂ S: Height 47 cm    Width 45 cm  
      Height 18.50"    Width 17.72"  
✂ M: Height 77 cm    Width 45 cm  
      Height 30.31"    Width 17.72"  
L: Height 107 cm    Width 45 cm  
      Height 42.13"    Width 17.72"

⚖ S: 7,5 kg | 16.53 lbs  
M: 11 kg | 24.25 lbs  
L: 12 kg | 26.46 lbs

⋮ Fabric, Trevira CS+ | CS, Revive 1, Clara 2, Remix 3, Hero, Tonus 4, Memory 2

---

## BuzziPlanter 45 Long

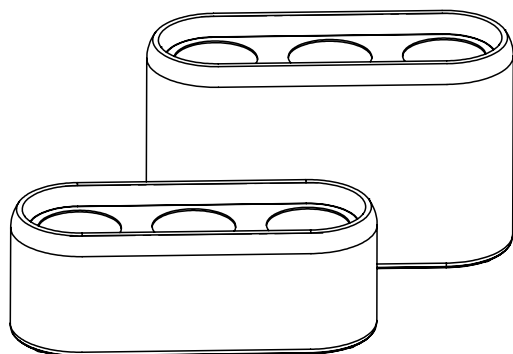

📏 S | M

🌲 Filling: Acoustic foam + Plywood, MDF  
Baseplate: Black MDF with plastic Feet

✂ S: Height 47 cm    Width 120 cm    Depth 45 cm  
      Height 18.50"    Width 47.24"    Depth 17.72"  
✂ M: Height 77 cm    Width 120 cm    Depth 45cm  
      Height 30.31"    Width 47.24"    Depth 17.72"

⚖ S: 19,5 kg | 42.99 lbs  
M: 28,5 kg | 62.83 lbs

⋮ Fabric, Trevira CS+ | CS, Revive 1, Clara 2, Remix 3, Hero, Tonus 4, Memory 2

---

## BuzziPlanter 80

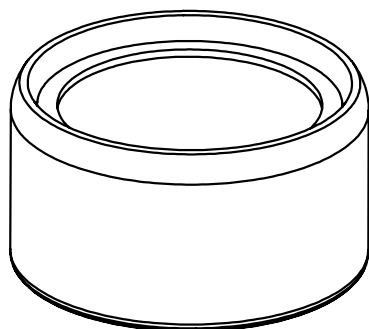

📏 S

🌲 Filling: Acoustic foam + Plywood, MDF  
Baseplate: Black MDF with plastic Feet

✂ S: Height 47 cm    Width 80 cm  
      Height 18.50"    Width 31.50"

⚖ S: 15,5 kg | 34.17 lbs

⋮ Fabric, Trevira CS+ | CS, Revive 1, Clara 2, Remix 3, Hero, Tonus 4, Memory 2

# Components

---

## Bottom



Bottom: Black MDF with plastic Feet

45: 4 plastic feet  
45 Long: 5 plastic feet  
80: 4 plastic feet

## Ring

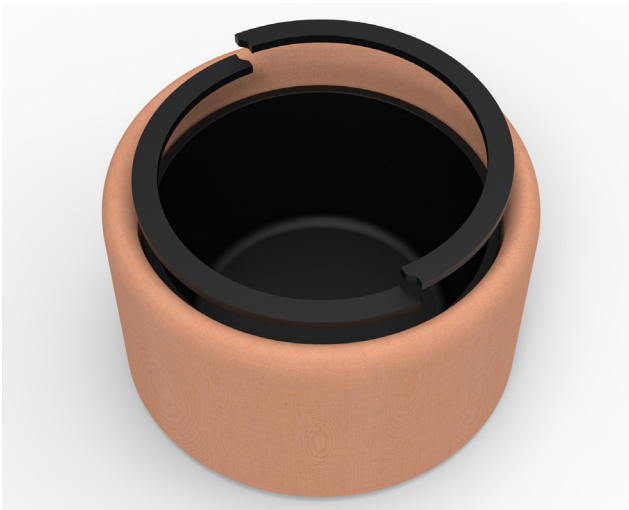

Black MDF ring made out of 2 interlocking parts

## Container



Black Plastic Container

45: 1x 12L Container  
45 Long: 3x 12L Containers  
80: 1x 90L Container

45: Width Ø 31,5 cm Height 23 cm  
Width Ø 12.40" Height 9.06"  
45 Long: Width Ø 31,5 cm Height 23 cm  
Width Ø 12.40" Height 9.06"  
80: Width Ø 67 cm Height 35 cm  
Width Ø 26.38" Height 13.78"

# Fabrics

## Fabric

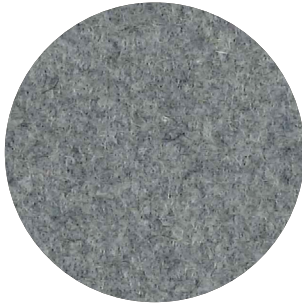

**Category A**

**Composition** 70% Recycled Wool, 25% Recycled Polyacryl,  
5% Recycled Other Fabrics

**Weight** 405 g/m<sup>2</sup> | 11.94 oz/yd<sup>2</sup>

**Abrasion resistance** 40.000 Martindale, 50,000 Wyzenbeek

**Flammability** EU: EN 1021.1/2006 | BS EN 1021.1/2006 (cigarette).  
EN 1021.2/2006 | BS EN 1021.2/2006 (match)  
USA: CAL TB 117 | ASTM E84 CLASS A

**Fastness to light** EU: 4 | USA 4

**Fastness to rubbing** EU: Wet 3-4 | Dry 4-5

**Fastness to crocking** USA: Wet 5 | Dry 5



## Trevira CS+ | CS

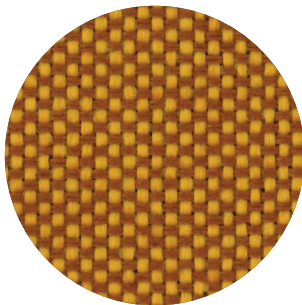

**Category A**

**Weight** 420 g/m<sup>2</sup> | 12.39 oz/yd<sup>2</sup>

**Composition** 100% Polyester, Trevira CS

**Abrasion resistance** 100.000 Martindale, 90,000 Wyzenbeek

**Flammability** BS 5852 part II: CRIB 5 | BS 7176 Medium Hazard  
USA: CAL TB 117 | M1 | B1 | EN 1021/1-2 | C1 |  
IMO Res. A652 (16)

**Fastness to light** EU: 6 | USA 5

**Fastness to rubbing** EU: Wet 4-5 | Dry 4-5

**Fastness to crocking** USA: Wet 5 | Dry 5



## Revive 1

kvadrat

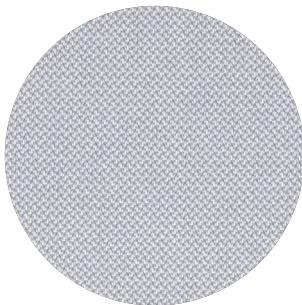

**Category A**

**Composition** 100% recycled polyester FR

**Weight** 430 g/lin.m

**Abrasion resistance** 60.000 Martindale rubs, EN ISO 12947

**Flammability** EN 1021-1/2 | DIN 4102 B1 | Önorm B1/Q1  
UNI 9175 1IM | US Cal. Tech. Bull. 117  
IMO A.652 (16)

**Fastness to light** Note 5-7, ISO 105-B02

**Fastness to rubbing** (ISO) dry 5, wet 4-5

**Pilling** Note 4-5, EN ISO 12945



## Clara 2

kvadrat

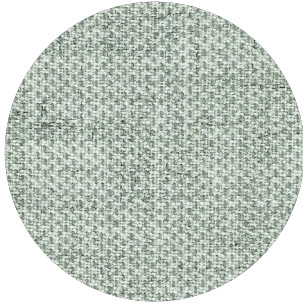

**Category B**

**Composition** 92% new wool, 8% nylon

**Weight** 400 g/lin.m

**Abrasion resistance** 80.000 Martindale rubs, EN ISO 12947

**Flammability** EN 1021-1/2 | BS 5852, ignition source 2-3 | DIN 4102 B2  
NF D 60 013 | UNI 9175 11M | US Cal. Tech. Bull. 117, Sec. E  
NFPA 260 | IMO A.652(16)

**Fastness to light** Note 5-7, ISO 105-B02

**Fastness to rubbing** (ISO) dry 4-5, wet 4

**Pilling** Note 4, EN ISO 12945



## Remix 3

kvadrat



**Category B**

**Composition** 90% new wool, 10% nylon

**Weight** 415 g/lin.m

**Abrasion resistance** 100.000 Martindale rubs, EN ISO 12947

**Flammability** EN 1021-1/2 | BS 5852 part 1  
Önorm B1/Q1 | NF D 60 013 | UNI 9175, 11M  
AS/NZS 1530.3 | Cal. Tech. Bull. 117-2013  
NFPA 260 | IMO FTP Code 2010:Part 8

**Fastness to light** Note 5-7, ISO 105-B02

**Fastness to rubbing** (ISO) dry 4-5, wet 4

**Pilling** Note 4, EN ISO 12945



## Hero

kvadrat

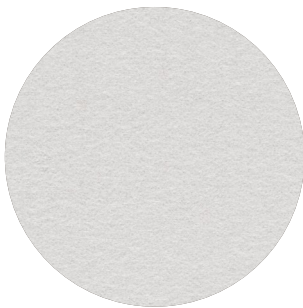

**Category C**

**Composition** 96% new wool, 4% nylon

**Weight** 580 g/lin.m

**Abrasion resistance** 45.000 Martindale rubs, EN ISO 12947

**Flammability** EN 1021-1/2 | DIN 4102 B2 | NF D 60 013  
UNI 9175 11M | US Cal. Bull. 117-2013 | NFPA 260  
IMO A.652 (16)

**Fastness to light** Note 5-6, ISO 105-B02

**Fastness to rubbing** (ISO) dry 4-5, wet 4-5

**Pilling** Note 3-4, EN ISO 12945



## Tonus 4

kvadrat

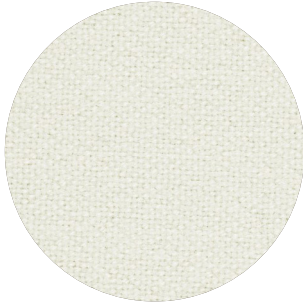

**Category** D

**Composition** 90% new wool, 10% Helanca

**Weight** 665 g/lin.m

**Abrasion resistance** 100.000 Martindale rubs, EN ISO 12947

**Flammability** EN 1021-1/2 | BS 5852 part 1 | DIN 4102 B2

Önorm B1/Q1 | NF D 60 013 | UNI 9175 11M

US Cal. Bull. 117-2013 | NFPA 260 | IMO A.652 (16)

**Fastness to light** Note 5-7, ISO 105-B02

**Fastness to rubbing** (ISO) dry 3-5, wet 3-5

**Pilling** Note 3, EN ISO 12945



## Memory 2

kvadrat

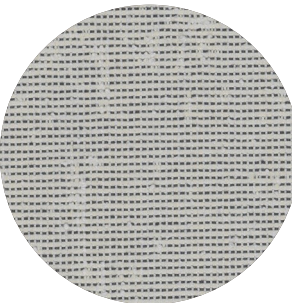

**Category** E

**Composition** 100% Trevira CS

**Weight** 700 g/lin.m

**Abrasion resistance**

35.000 rubs acc. to the Martindale method, EN ISO 12947

**Flammability** EN 1021-1/2 | DIN 4102 B1 | Önorm B1/Q1

NF D 60 013 | NF P 92 507 M1 | UNI 9175 11M

UNI 9177 classe 1 | US Cal. Tech. Bull. 117

IMO A.652 (16)

**Fastness to light** Note 5-8, ISO 105-B02

**Fastness to rubbing** (ISO) dry 4-5, wet 4-5

**Pilling** Note 4, EN ISO 12945



# Dimensions

## BuzziPlanter 45

Small

Top

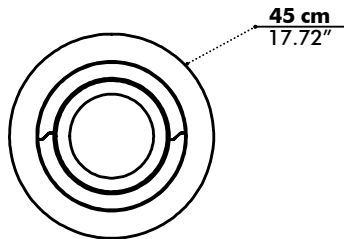

Side

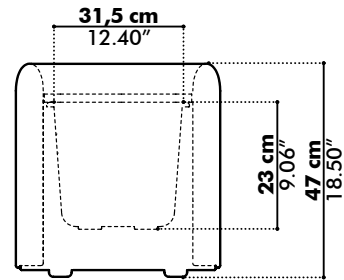

Medium

Top

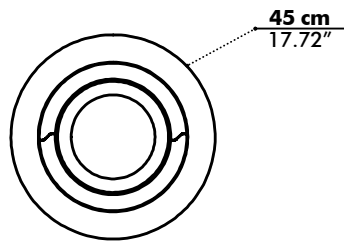

Side

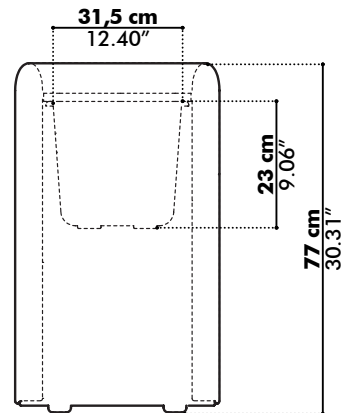

Large

Top

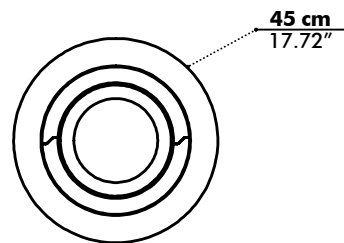

Side

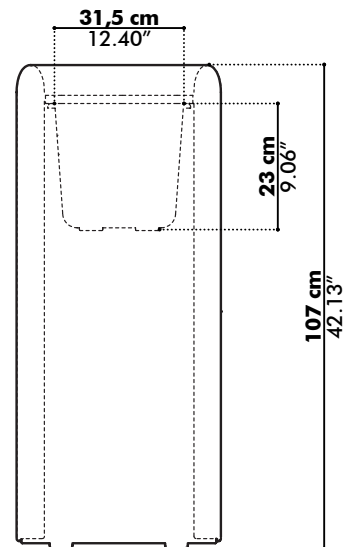



---

# BuzziPlanter 45 Long

Small

Top

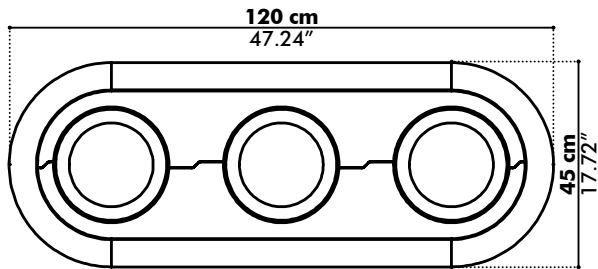

Side

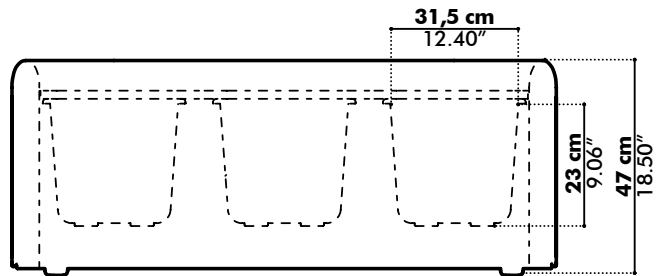

Medium

Top

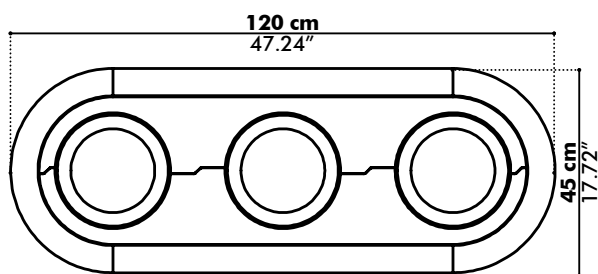

Side

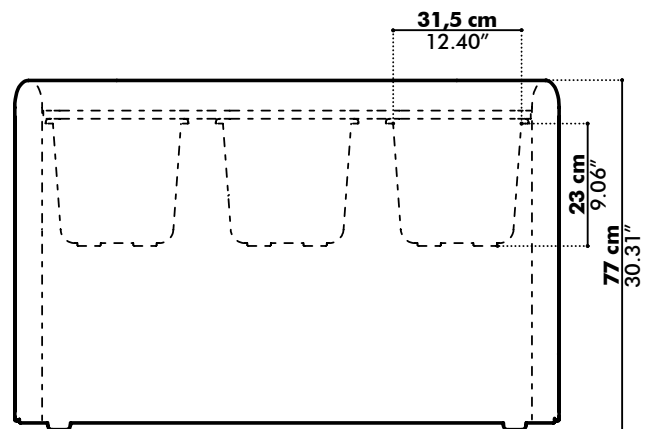

---

# BuzziPlanter 80

Small

Top

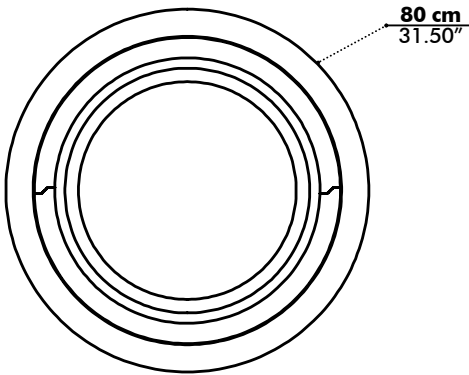

Side

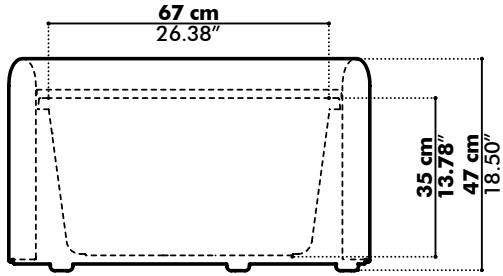

# Acoustics

## BuzziPlanter

Equivalent sound absorption area in m<sup>2</sup> per object

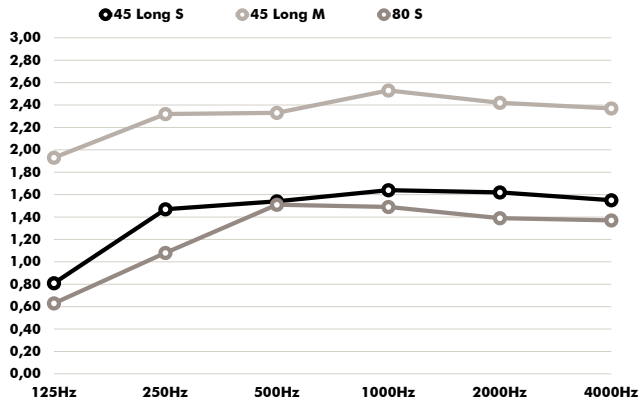

Hz	45 Long S Aeq/m <sup>2</sup>	45 Long M Aeq/m <sup>2</sup>	80 S Aeq/m <sup>2</sup>
125	0.81	1.93	0.63
250	1.47	2.32	1.08
500	1.54	2.33	1.51
1000	1.64	2.53	1.49
2000	1.62	2.42	1.39
4000	1.55	2.37	1.37