

# creva desk



KUSCH+CO  
by Nowy Styl

Meinema | De Meubelmakelaar | 0031 - 20 311 8396



Creva desk – an extraordinary table series that succeeds in transposing the design aesthetics of home furniture to the office environments. Its minimalist design language is typified by round shapes and well-balanced proportions. The materiality of the natural material wood reinforces this aura. A multitude of ingenious features is incorporated into the table construction. The rail-free substructure offers plenty of legroom. The steel leg mountings with aluminium supporting beams combined with the steel lateral bars guarantee the best possible stability. The central joint in the table top can hold a variety of freely positionable power modules, view protection panels and trays. Creva desk excels in versatility – ideally suited for either individual workstations or large-scale conference configurations, not forgetting the high tables. Geared towards a plethora of environments, from offices to staff restaurants and cafeterias, from recreation rooms to waiting areas, from meeting points to break-out areas.



**Content**

Variations	10
Product data	16
Materials, finishes	31
Fire Prevention, quality, sustainability	34



**Design by kaschkasch**

In 2011, Florian Kallus and Sebastian Schneider founded their own design studio. This duo focuses their creative energy on product design & art direction. In co-operation with companies like Kusch+Co, they create classical and modular furniture designs, characterised by a synthesis of innovation, functionality and aesthetics.











KUSCHCO





# Variations

---

## 6850 Square / rectangular table / 6855 Curved rectangle table, without top joint

An exceptional wide spectrum of tables geared towards a plethora of environments. Available with a square table top measuring 150 × 150 cm. Either rectangular or curved rectangle table tops in a variety of widths up to 180 cm and lengths up to 360 cm resp. 420 cm. All table variations come with ample overhang on the sides, offering plenty of legroom.



6850/6



6850/6



6855/6

---

## 6870 Round table, without top joint

The round table is available with two table top sizes, either with a 120 cm or a 150 cm diameter. Featuring a large overhang on all sides.



6870/6

---

## 6860 Rectangular high table / 6865 Curved rectangle high table, without top joint

The high table has become a favourite meeting point. Either for a spontaneous exchange of ideas while standing or a short meeting on the bar stools with matching design aesthetics. Available either with a rectangular or a curved rectangular table top measuring 100 cm resp. 110 cm in width and 200 cm in length.



6860/6



6865/6

---

## 6880 Rectangular table / 6885 Curved rectangle table, with top joint

A multifunctional table geared towards a plethora of environments. The central joint is designed to hold a variety of power modules, view protection panels and trays. Available with either rectangular or curved rectangle table tops in a wide variety of widths up to 180 cm and lengths up to 360 cm resp. 420 cm. All table variations come with ample overhang on the sides, offering plenty of legroom.



6880/6



6885/6

---

## 6890 Rectangular high table / 6895 Curved rectangle high table, with top joint

The high table variation excels in functionality through the central joint combined with the optional extras. Ideally suited for work, either while standing or sitting on a bar stool. Available either with a rectangular or a curved rectangle table top measuring 100 cm resp. 110 cm in width and 200 cm in length.



6890/6



6895/6









# Product data

## 6800 Creva desk, without top joint

### 6850/6

Square table, without top joint

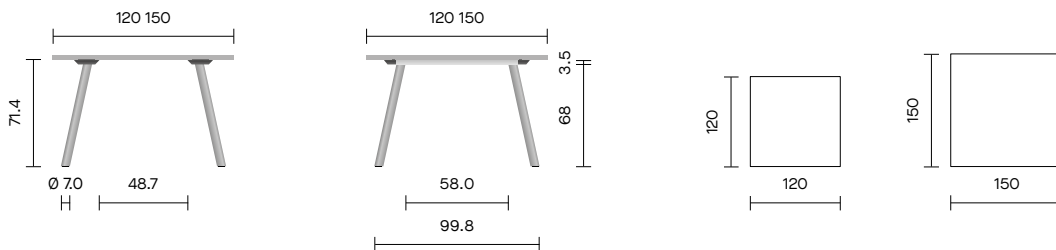

### 6850/6

Rectangular table, without top joint

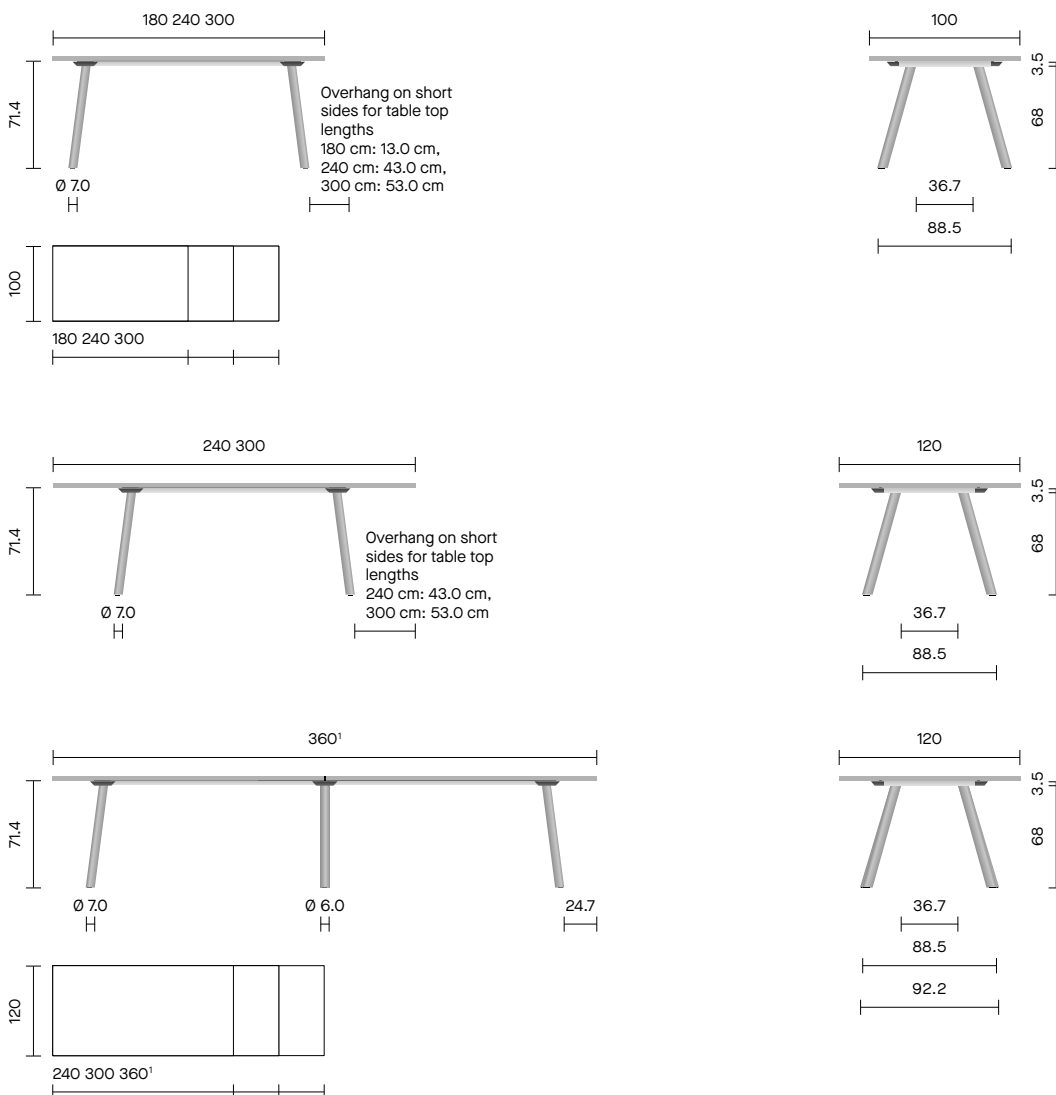

<sup>1</sup> Top in two parts

<sup>2</sup> Top in four parts

Dimensions in cm



6800 Creva desk, without top joint

**6850/6**

Rectangular table,  
without top joint

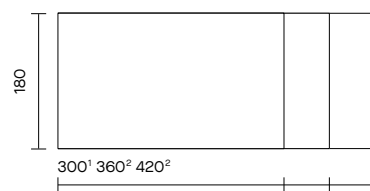
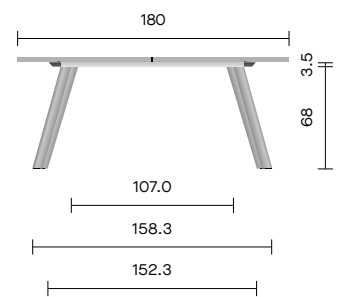
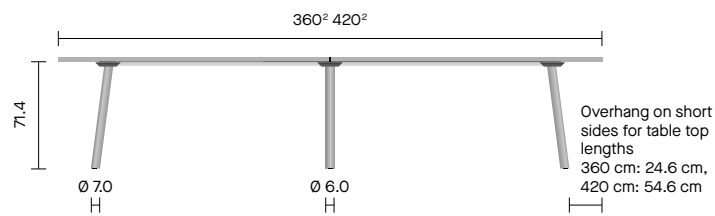
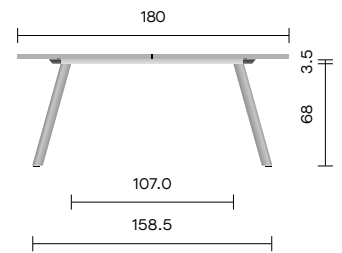
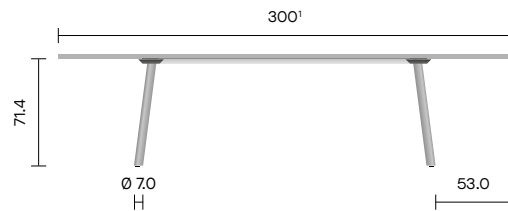
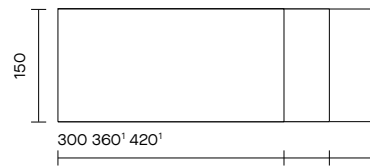
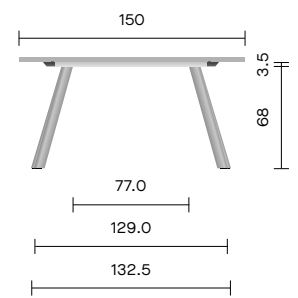
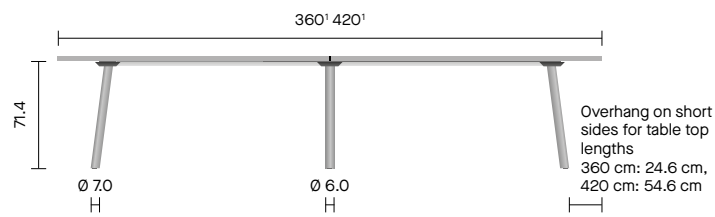
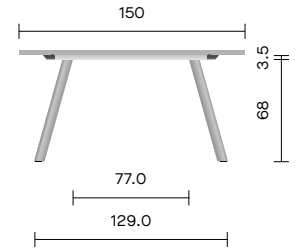
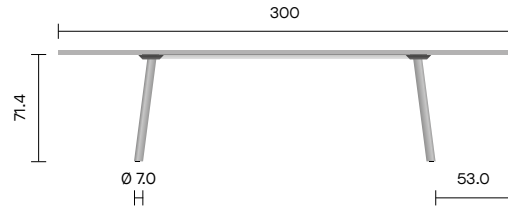

# Product data

## 6800 Creva desk, without top joint

### 6870/6

Round table,  
without top joint

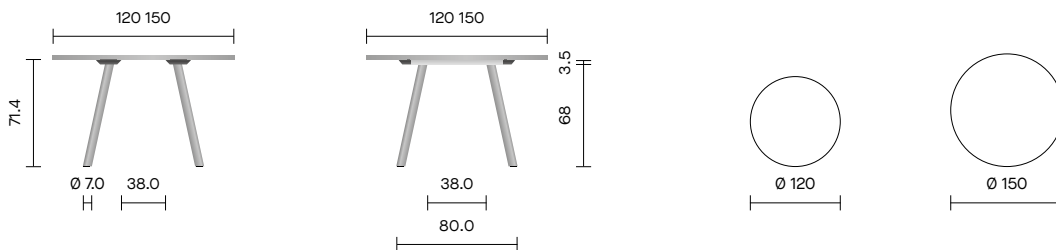

### 6855/6

Curved rectangle table,  
without top joint

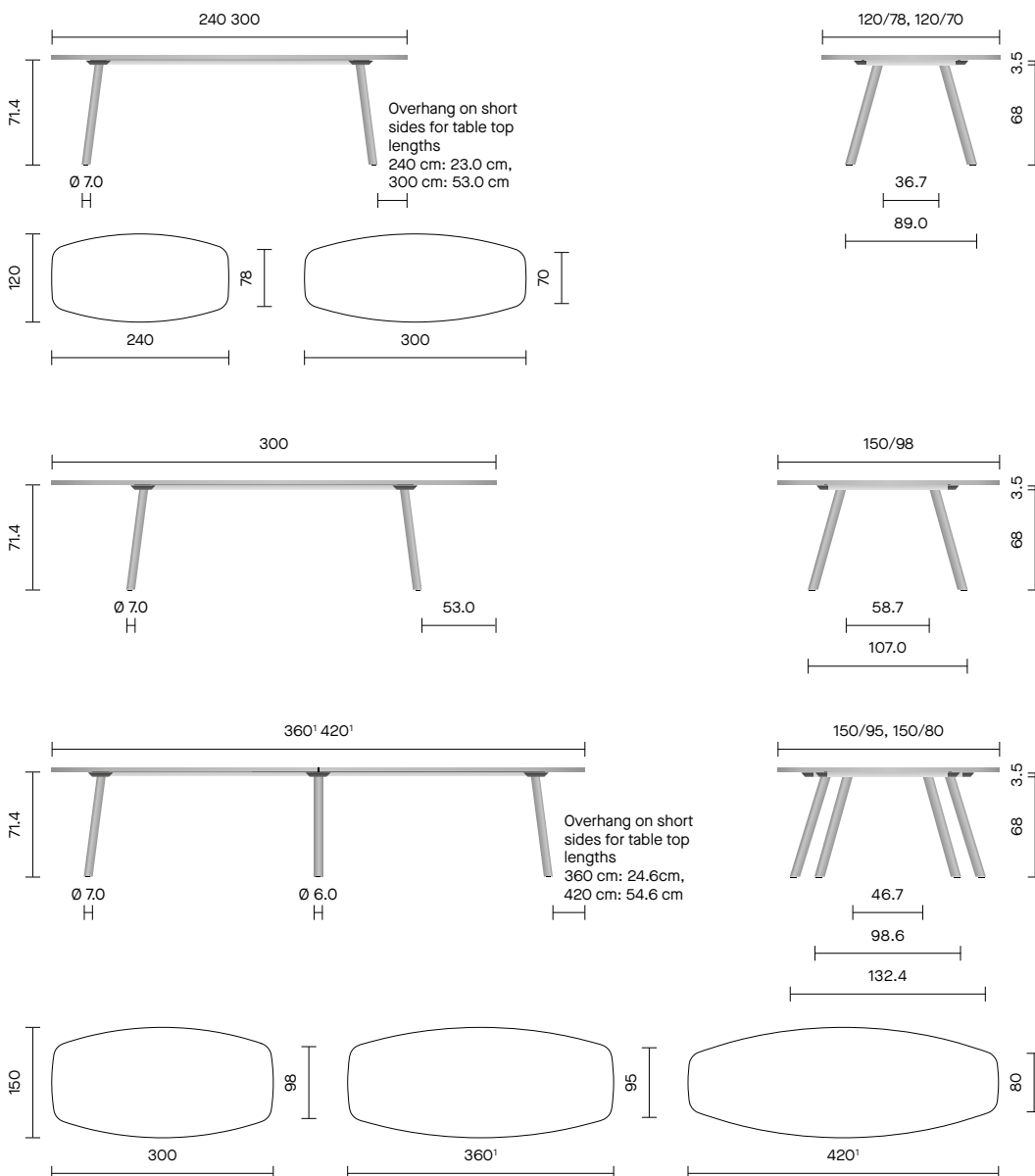

<sup>1</sup> Top in two parts

<sup>2</sup> Top in four parts

Dimensions in cm

6800 Creva desk, without top joint

**6855/6**

Curved rectangle table, without top joint

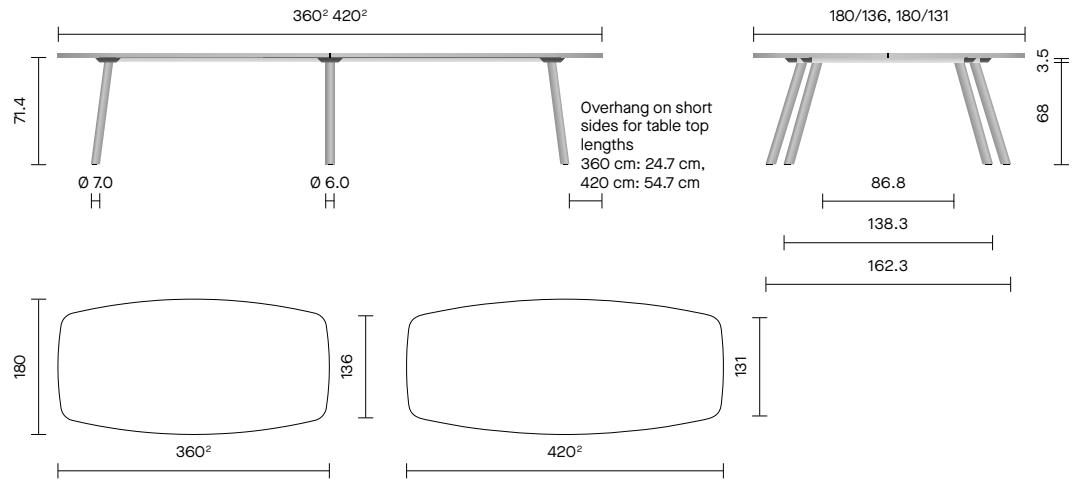

**6860/6**

Rectangular high table, without top joint

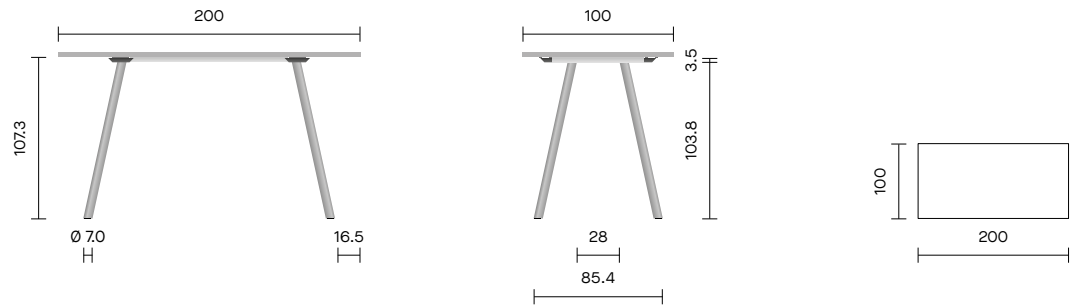

# Product data

## 6800 Creva desk, without top joint

### 6865/6

Curved rectangle high table,  
without top joint

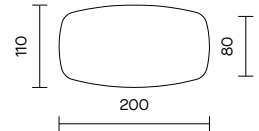
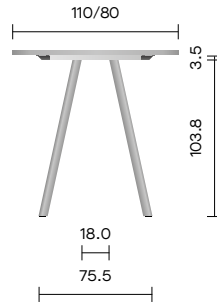
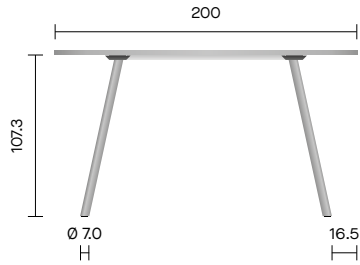

Table tops

**D** **E** **J** **K**

Lippings

**1** **2** **6** **8** **30** **31**

### Accessories

- Plastic glides
- Felt glides
- Centrally positioned power and data modules
- Cable duct, anthracite felt
- 1 leg for power and data with power cable









# Product data

## 6800 Creva desk, with top joint

### 6880/6

Rectangular table,  
with top joint

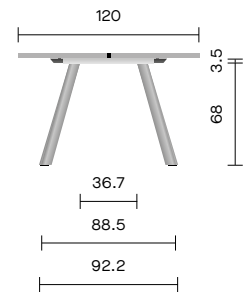
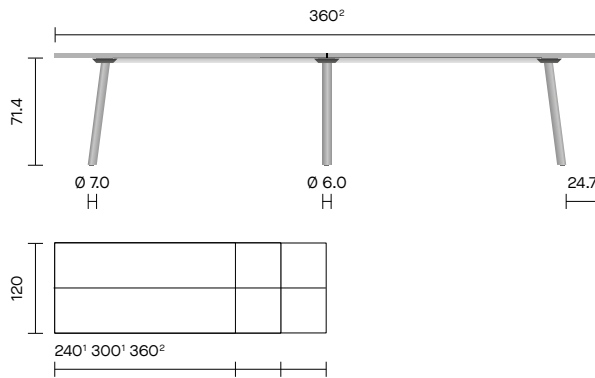
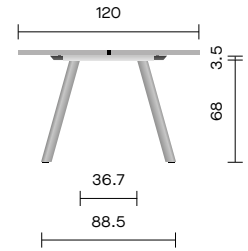
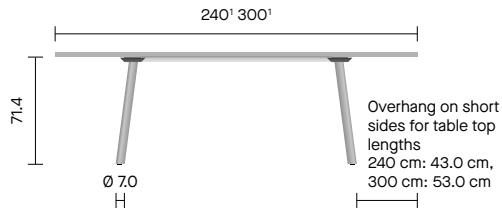
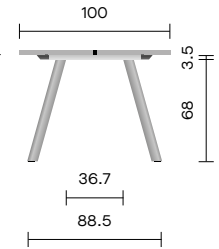
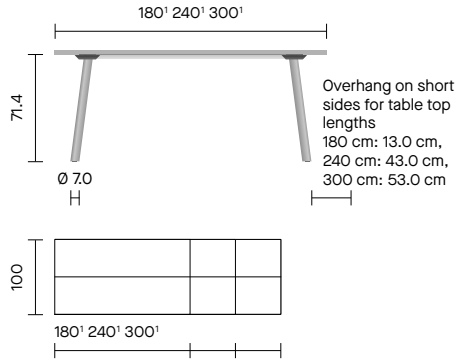

<sup>1</sup> Top in two parts  
<sup>2</sup> Top in four parts

Dimensions in cm



6800 Creva desk, with top joint

**6880/6**

Rectangular table,  
with top joint

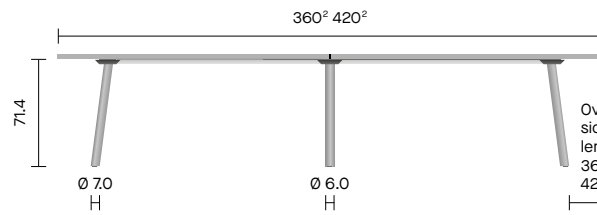
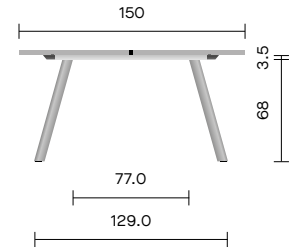
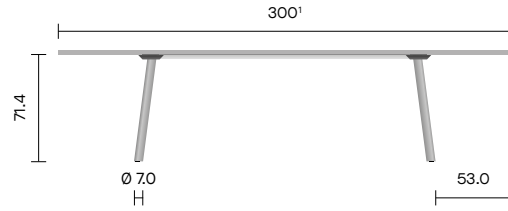

Overhang on short  
sides for table top  
lengths  
360 cm: 24.6 cm,  
420 cm: 54.6 cm

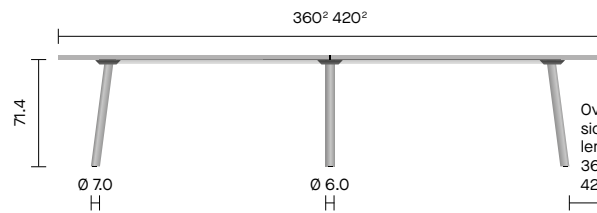
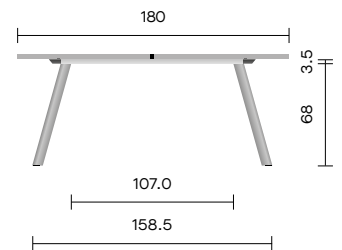
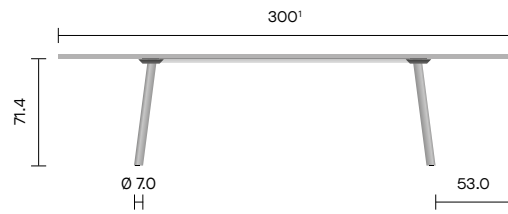
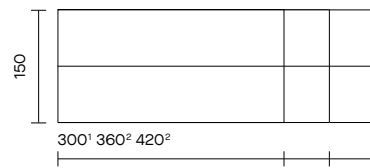
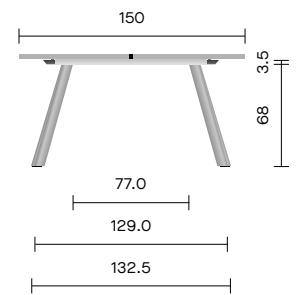

Overhang on short  
sides for table top  
lengths  
360 cm: 24.6 cm,  
420 cm: 54.6 cm

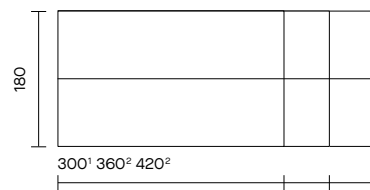
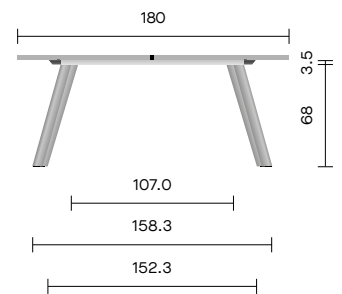

# Product data

## 6800 Creva desk, with top joint

### 6885/6

Curved rectangle table, with top joint

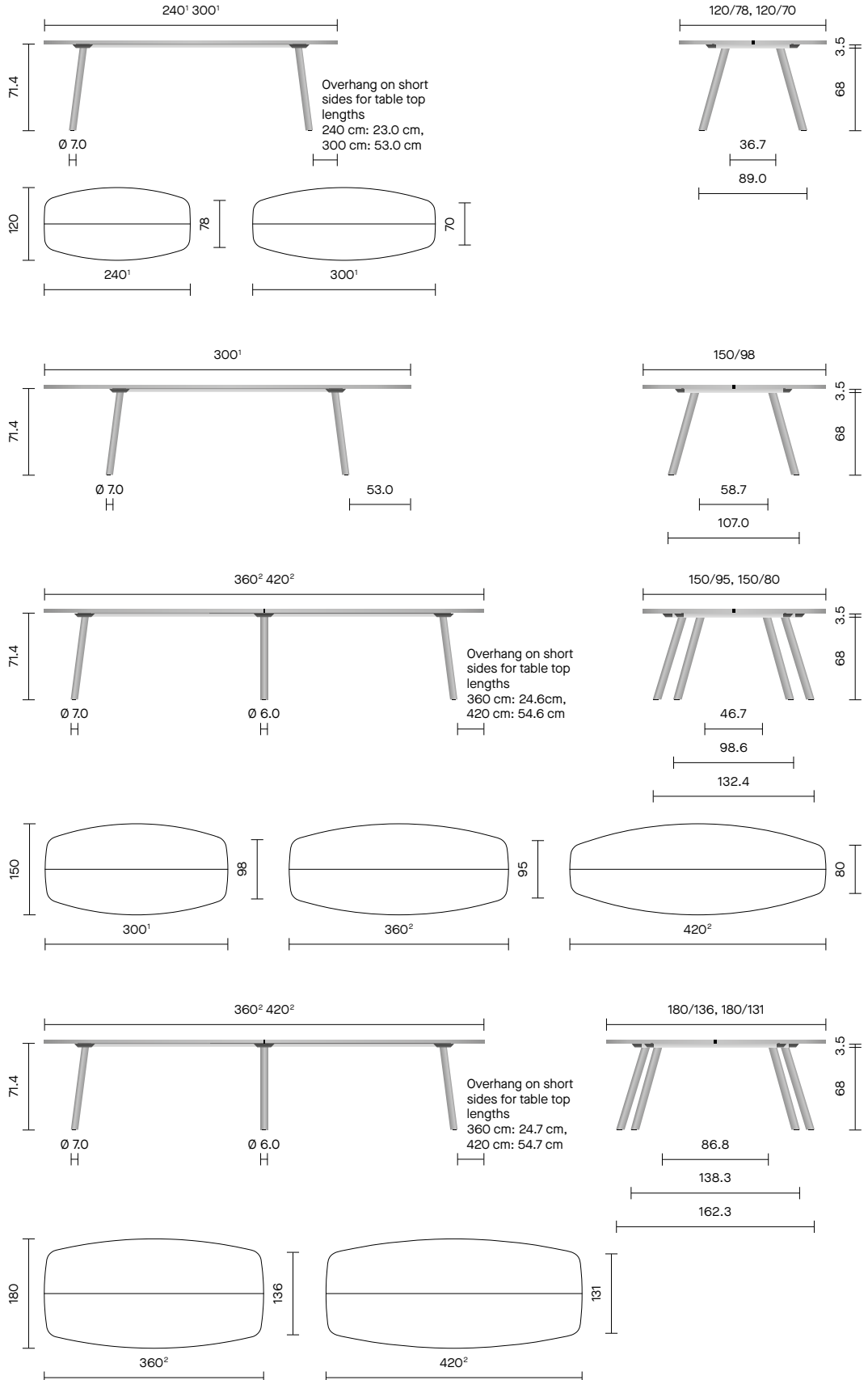

<sup>1</sup> Top in two parts  
<sup>2</sup> Top in four parts

Dimensions in cm

## 6800 Creva desk, with top joint

### 6890/6

Rectangular high table,  
with top joint

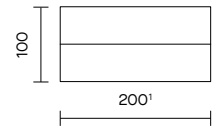
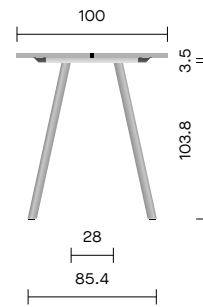
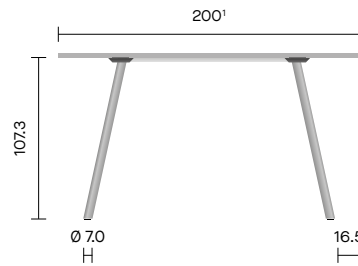

### 6895/6

Curved rectangle high table,  
with top joint

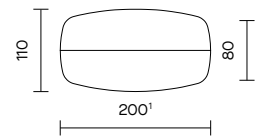
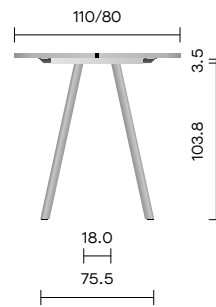
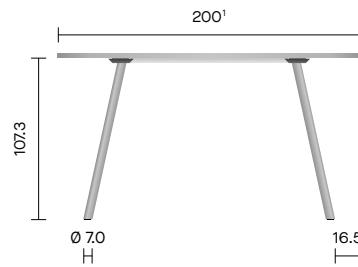

Table tops

**D** **E** **J** **K**

Lippings

**1** **2** **6** **8** **30** **31**

### Accessories

- Plastic glides
- Felt glides
- View protection panel
- Tray







shaping the way we sit

# Product data

## 6800 Creva desk, with top joint

### Power and data

- Power and data box for 1 insert
  - 1 insert country-specific power socketor
  - 1 insert dual USB charger
- Power and data box for 2 inserts
  - 2 inserts country-specific power socketor
  - 2 inserts dual USB chargeror
  - 1 insert country-specific power socket, 1 insert dual USB charger
- Power and data box for 3 inserts
  - 3 inserts country-specific power socketor
  - 3 inserts dual USB chargeror
  - 2 inserts country-specific power socket, 1 insert dual USB chargeror
  - 1 insert country-specific power socket, 2 inserts dual USB charger
- Cable duct, anthracite felt
- 1 leg for power and data with power cable



## 6800 Creva desk

### Curved rectangle tables

In order to measure the widths on the short sides, we measure the table top as if it didn't have rounded edges.



# Materials, finishes

## 6800 Creva desk

### Legs, aluminium supporting beams

- Legs natural beech or stained acc. to standard collection
- Leg mountings RAL 9006 white aluminium powder coated
- Aluminium supporting beams anodised mat silver
- Black plastic closing caps

### Power and data

- Cable duct, anthracite felt
- Leg for power and data, natural beech or stained acc. to standard collection
- Power and data box, natural beech or stained acc. to standard collection (for tables with top joint)



### Accessories (for tables with top joint)

- View protection panel, entirely upholstered, fabric from standard collection (not available in the material leather)
- Tray, natural beech or stained acc. to standard collection

### Beech stains K



natural beech



global beech  
K 05



maple  
K 01



cream  
K 04



oak  
K 40



tobacco  
K 02



sienna  
K 10 (P 10)



puce  
K 11 (P 11)

### Beech stains S

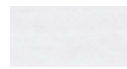

arctic  
S 42



white  
S 40



salem  
S 54



pimento  
S 57



tinkerbelle  
S 55



scampolo  
S 56



midnight blue  
S 38



light grey  
S 39



black\*  
S 10

\* Not available for beech and maple veneer.

### Oak stains K



natural oak



cognac oak  
K 45 (P 45)



solid oak  
K 43 (P 43)



lounge oak  
K 44 (P 44)



noce oak  
K 46 (P 46)



light oak  
K 50



dark oak  
K 51

### Closed porous veneer tops



BU Beech



AH Maple

### Open porous veneer tops



NB Walnut



ES Ash



EI Oak

### Powder coating



RAL 9006  
white aluminium  
(metallic effect)  
for leg mountings

# Materials, finishes

## Available decor sizes laminate HPL Resopal

HPL = High Pressure Laminate

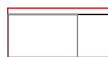

### 300 x 150 cm

High pressure laminated tops HPL Resopal frosty white, alabaster, shadow nut and north sea.

### 300 x 130 cm

High pressure laminated tops HPL Resopal maple, global beech, sol oak, silver grey, soft grey, ebony and Resopal Antibacterial.



### 210 x 130 cm

Low flammability high pressure laminated tops HPL Resopal global beech and silver grey. Other colours are available on request for larger orders.

## Laminate HPL Resopal®

RESOPAL

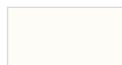

frosty white  
1573-60



alabaster  
D 431-60



maple  
4230-60



global beech  
4306-60<sup>1</sup>



sol oak  
4176-60



shadow nut  
4079-60

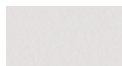

silver grey  
0160-60<sup>1</sup>

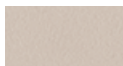

soft grey  
1500N-60



north sea  
D90-60



ebony  
10622-60

## Laminate HPL Resopal® Antibacterial

RESOPAL

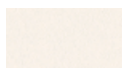

pearl white  
0105-60

## Laminate Fenix NTM®

FENIX NTM

## Available decor sizes laminate Fenix NTM



### 300 x 150 cm

Laminated tops Fenix NTM.

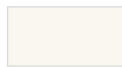

bianco kos  
0032



verde comodora  
0750



blu fes  
0754



rosso jaipur  
0751



cacao orinoco  
0749



grigio antrim  
0752



grigio bromo  
0724



nero ingo  
0720

## Types of lipping

1 2

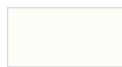

ABS snow white

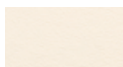

ABS white<sup>2</sup>



ABS maple<sup>2</sup>



ABS beech<sup>2</sup>



ABS oak



ABS shadow nut



ABS silver grey<sup>2</sup>

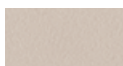

ABS soft grey



ABS north sea



ABS ebony



ABS black

6 8



massive beech<sup>3</sup>

30 31

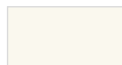

PP bianco kos



PP verde comodora



PP blu fes



PP rosso jaipur



PP cacao orinoco



PP grigio antrim



PP grigio bromo



PP nero ingo



<sup>1</sup> Also available in low flammability finish.

<sup>2</sup> Antibacterial coating

<sup>3</sup> Optionally standard stain (HPL top)



## Table tops



**D** 18.0 kg/m<sup>2</sup>

FSP-HPL / 27 mm  
Core: 3-layered chipboard with a laminate finish (HPL or Fenix NTM).



**E** 17.5 kg/m<sup>2</sup>

FSP-FU / 27 mm  
Core: 3-layered chipboard with a high-grade wooden veneer finish.



**J** 20.5 kg/m<sup>2</sup>

MDF-HPL / 27 mm  
Core: medium density fibreboard with a laminate finish (HPL or Fenix NTM).



**K** 20.0 kg/m<sup>2</sup>

MDF-FU / 27 mm  
Core: medium density fibreboard with a high-grade wooden veneer finish.

## Lippings



**1**  
KK2 / 2 mm  
2 mm plastic ABS.



**2**  
FA2 / 2 mm  
2 mm plastic ABS on MDF, 50 mm chamfered lipping.



**6**  
HK2 / 2 mm  
2 mm wood.



**8**  
FB2 / 2 mm  
2 mm wood on MDF, 50 mm chamfered lipping.













**30**  
KK1 / 1 mm  
1 mm plastic PP.



**31**  
FA1 / 1 mm  
1 mm plastic PP on MDF, 50 mm chamfered lipping.

## Which table top, which lipping?

This chart gives an overview of all combinations which are technically possible.

						
	<b>1</b>	<b>2</b>	<b>6</b>	<b>8</b>	<b>30</b>	<b>31</b>
 <b>D</b>	•		•		•	
 <b>E</b>			•			
 <b>J</b>		•		•		•
 <b>K</b>				•		

# Solutions, quality, sustainability

Excerpt

## Fire Prevention

Depending on the environment, contract seating has to be able to fulfil very specific requirements. Interior designers and planners sometimes have to clear difficult hurdles: such as exacting fire prevention regulations. Kusch+Co has worked out individual solutions:

## Wooden parts

As standard, wooden parts as well as high-grade wooden veneer finishes and high-grade wooden veneer lippings are protected by a UV curing, environmentally harmless, water-based lacquer meeting all the requirements of "low flammability" acc. to DIN EN 13501 B s2 d0.

## Table tops

Table tops with a 3-layered chipboard core, and featuring either a HPL or real wood veneer surface are also available in a low flammability finish.

Please contact us if you wish to receive the test reports.

Please contact us to receive further information.

All the power and data modules feature safety-tested components bearing the VDE mark. All tables with power and data modules meet the requirements of the European Directives, standards and regulations currently in effect. The components are all fitted, tested, labelled, and documented by skilled and trained personnel.

We are certified in compliance with DIN EN ISO 9001:2015. In our own laboratory, we test our products before their market launch whether they comply with the normative requirements applicable to contract seating, task chairs, and tables, and issue a Declaration of Conformity.

We happily make these Declarations of Conformity as well as our brochure "Mission Statement Quality" providing detailed information on our test procedures available to you – please contact us.



## Sustainability

Kusch+Co products stand for long life cycles and optimum recyclability. From the first design drafts of a new product, we take all environmental-relevant components and production processes into consideration, ranging from the materials selection and the design all the way to the manufacturing processes which also contribute towards our sustainable energy balance.

Environmental Product Declarations are available for all series, in accordance with DIN EN ISO 14021 Type II, providing more information about all environmentally relevant aspects, including the Credit Points for the LEED certification of a building. Please contact us for more information.

## Quality

Our environmental and quality management systems are certified acc. to DIN EN ISO 14001:2015 and to DIN EN ISO 9001:2015.

External audits as well as our in-house laboratory safeguard our quality level.

The tables of series 6800 Creva desk meet the requirements with regard to stability, static and dynamic load as well as strength and durability in compliance with the current European Directives, standards and regulations.

On top of this, we voluntarily test the strength of our table frames with an additional horizontal load test using higher weights and more test cycles.



**6800 Creva desk**  
Environmental aspects

**KUSCH+CO**  
by Hovov Styl

**Environmental responsibility**

Long before the production of a new series, Kusch+Co starts thinking about the possible environmental impact of the production processes and the required components.

**Sustainability**

Kusch+Co understands sustainability as the realistic, manageable and economically viable combination of environmental protection, economics and CSR, not only in terms of production, but also how we communicate with our fellow men, our staff members and partners. Sustainability cannot be measured, but it can be sensed.

**Quality assurance**

In order to guarantee a constant high-level product quality, Kusch+Co is certified in accordance with the quality management system DIN EN ISO 9001:2015 and the environmental management system DIN EN ISO 14001:2015. The latter is a 5-year reciprocity on standard.

**Life Cycle**

**1 Materials**

- The models of series 6800 Creva desk are free from hazardous materials (lead, mercury, PVC).
- All components of series 6800 Creva desk comply with the legal limit standards.
- All plastic parts are labelled according to recycling.
- The steel products meet the criteria of emission class E1.
- All wood products originate from sustainable, legal and verified sources.
- Series 6800 Creva desk contains no substances included in the candidate list for authorization according to § 2, 21 of Regulation (EC) No 1907/2006 ("REACH").

**2 Production**

- Metal coating**
- The powder coating and the anodization are free from volatile organic compounds (VOC) and heavy metals and therefore environmentally harmless.

**3 Lacquer finish on wood**

Through the use of UV-curing, water-based lacquers in combination with a filter including fine filtering a clear spray cabinet with ultraviolet lamping (since April 2016), we were able to reduce the solvent by an absolute minimum. On top of this, our painting centers have been retrofitted with a dry filtration system, reducing the wet extraction system, and saving energy and water. The dry filter achieves the best possible result in collecting the overspray, which can be reused the regular household waste when dried. The used UV-curing, water-based lacquers are exempt of HMs and any other harmful substances.

**4 Usage**

- A long service life is guaranteed with wood parts being interchangeable and reworkable. This is our contribution to an efficient resource management.

**5 Waste disposal**

- At the end of their service life, the models of series 6800 Creva desk can be dismantled by our professional service who will separate the materials correctly by type.
- The models of series 6800 Creva desk are recyclable to approx. 90%.
- The recyclability is achievable in adhesives, greases, oil, wood, the end screen.

**3 Transportation**

- The transportation energy is offset by the accompanying packaging.
- The packaging material is reused before it is recycled.
- Kusch+Co dual disposal system is certified by Intermarch. Approximately 20 tonnes of packaging material is recycled every year.

**5 Waste disposal**

- All types of plastic waste (black, transparent, semi-transparent) are collected by professional waste processing companies and 100% recycled. As wood residues, resulting from wood-working, are used to heat the factory, saving precious heating oil.







**6800 Creva desk**  
Environmental aspects

**KUSCH+CO**  
by Hovov Styl

**Material composition**

Model	6800/6	6870/6	6880/6	6890/6
Weight	30,3 kg	46,7 kg	54,7 kg	108,8 kg
Dimensions (in cm)	300x100	600x100	600x100	600x140
Recyclable percentage	26,4%	22,6%	25,4%	22,6%
Recyclability	92,6%	94,6%	92,2%	92,3%

**6800/6 Rectangular table, without top joint**  
300 x 100 cm, chipboard 27 mm, HPL, plastic-lipping

Chipboard: 68,2%  
HPL: 8,5%  
Solid wood: 8,0%  
Plastic: 0,3%  
Steel: 3,3%  
Aluminium: 8,8%  
Miscellaneous: 10,9%

**6870/6 Round table, without top joint**  
Ø 100 cm, chipboard 27 mm, HPL, plastic-lipping

Chipboard: 40,5%  
HPL: 7,9%  
Solid wood: 12,0%  
Plastic: 0,3%  
Steel: 5,9%  
Aluminium: 12,2%  
Miscellaneous: 0,6%

**6880/6 Rectangular high table, without top joint**  
300 x 100 cm, chipboard 27 mm, HPL, plastic-lipping

Chipboard: 44,4%  
HPL: 7,9%  
Solid wood: 16,1%  
Plastic: 0,3%  
Steel: 5,9%  
Aluminium: 12,2%  
Miscellaneous: 0,5%

**6890/6 Rectangular table, with top joint**  
600 x 140 cm, chipboard 27 mm, HPL, plastic-lipping

Chipboard: 7,1%  
HPL: 8,9%  
Solid wood: 6,0%  
Plastic: 0,2%  
Steel: 3,3%  
Aluminium: 12,2%  
Miscellaneous: 0,7%

