

# AARON

Pio & Tito Toso | 2020



# AARON

Pio & Tito Toso | 2020

It was born generous, attentive and dynamic. You could call it a friend, one of the family. It was born double, like the double "A" in its name. AARON, a stool and a table all in one. It is an elegant and functional solution for all contexts, reducing space and highlighting privacy. It has an embracing seat and a metal core giving rise to a column that becomes a swivel tabletop. At different heights, also with a footrest, AARON is the ideal solution for all work, meeting and relaxation needs. The designers who started this small revolution in the world of Lapalma stools are the Venetian brothers PIO&TITOTOSO. A story of complicity and understanding. A dual story. A great idea.



# AARON

Pio & Tito Toso | 2020

## S436 stool with swivel table top h52

Stool with base in powder coated steel h52. Swivel seat upholstered with fire retardant moulded foam covered with fabric, ecoleather or leather and eccentric pivoting tablet in aluminium. Felt under the base. Also available with small base for floor fixing.

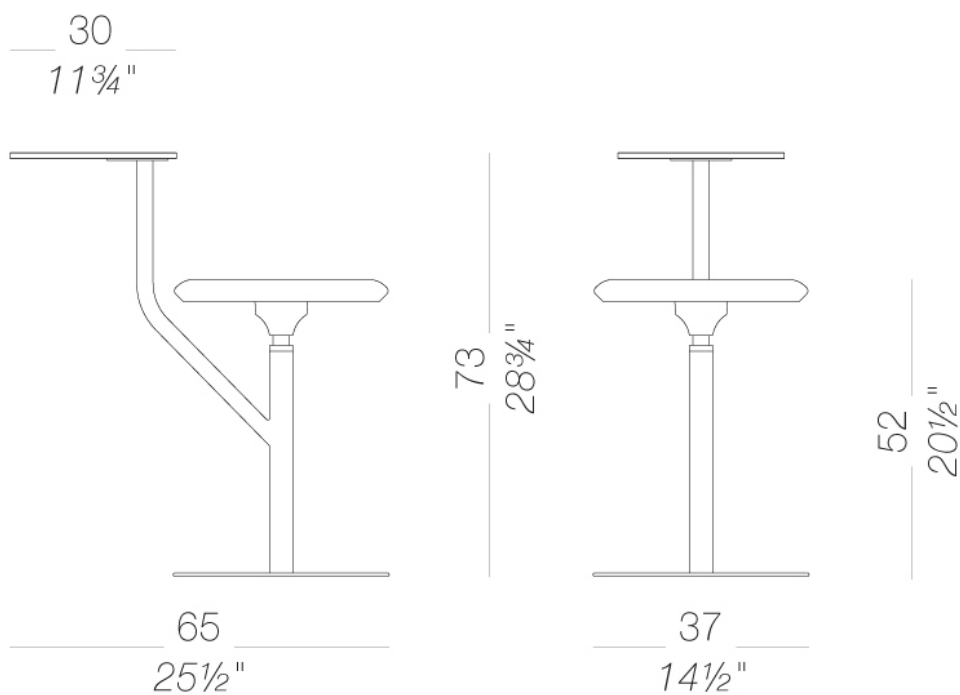

# AARON

Pio & Tito Toso | 2020

## S440 stool with swivel table top h60

Stool with base in powder coated steel h60. Swivel seat upholstered with fire retardant moulded foam covered with fabric, ecoleather or leather and eccentric pivoting tablet in aluminium. Felt under the base. Also available with small base for floor fixing.

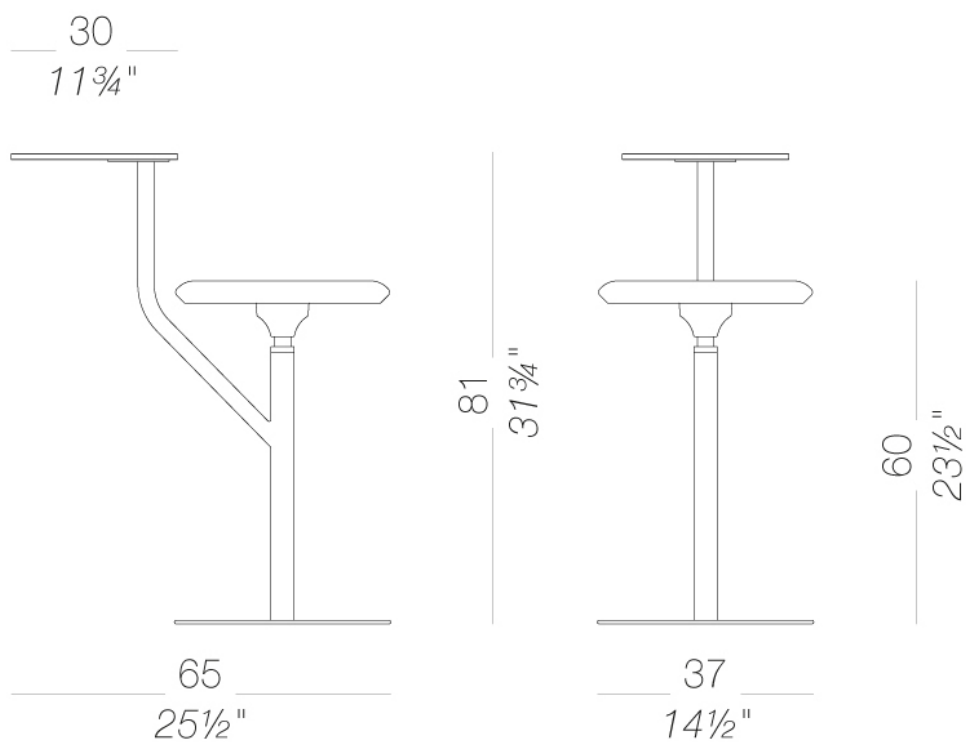

# AARON

Pio & Tito Toso | 2020

## S444 stool with swivel table top h78



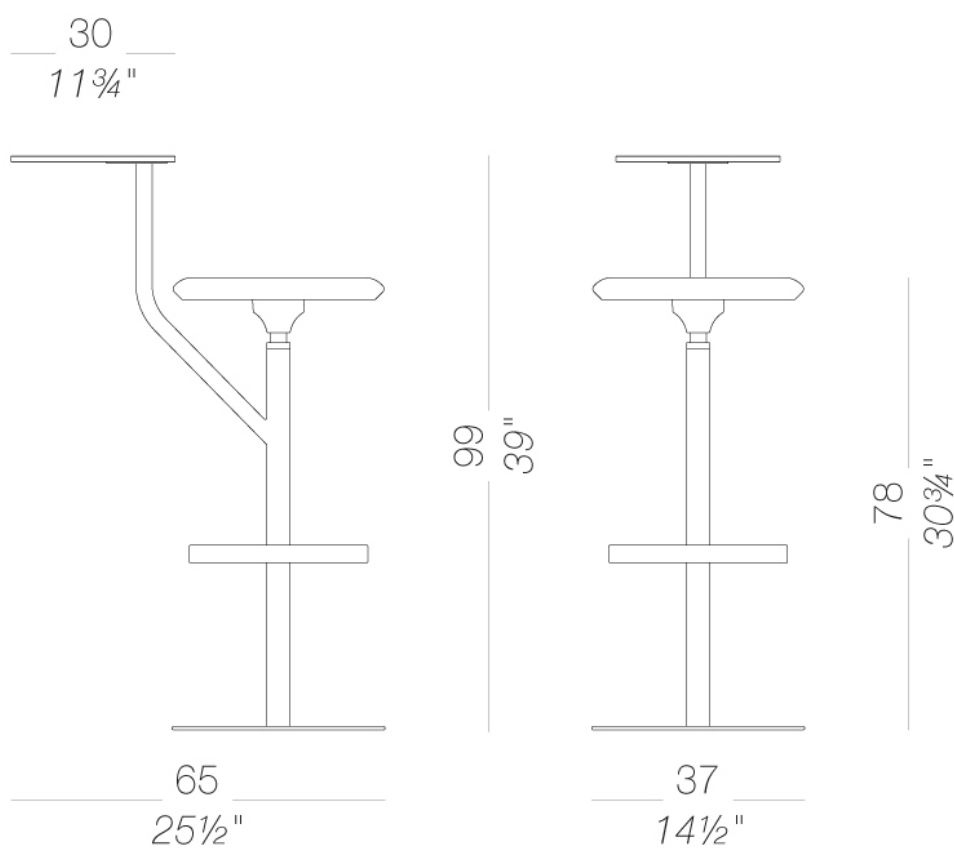



Stool with base and footrest in powder coated steel. Swivel seat upholstered with fire retardant moulded foam covered with fabric, ecoleather or leather and eccentric pivoting tablet in aluminium. Felt under the base. Also available with small base for floor fixing.



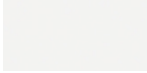









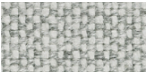



# AARON

Pio & Tito Toso | 2020





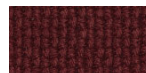
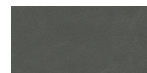

## frame

							
powder coating black 1 Colors	powder coating white 1 Colors	powder coating perla 1 Colors	powder coating celeste 1 Colors	powder coating mattone 1 Colors	powder coating caffè 1 Colors	powder coating oliva 1 Colors	powder coating tortora 1 Colors

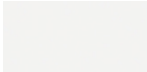
## seat

							
fabric Hallingdal 65 47 Colors	fabric Canvas 2 40 Colors	fabric Steelcut Trio 3 48 Colors	fabric Remix 2 24 Colors	fabric Clara 2 24 Colors	fabric Fiord 24 Colors	fabric Divina MD 24 Colors	fabric Divina Melange 2 24 Colors
							
fabric Tonica 2 39 Colors	fabric Medley 37 Colors	fabric Maya 43 Colors	fabric Jet 44 Colors	fabric Lapalma Smart 18 Colors	soft-leather soft-leather 7 Colors	ecoleather GRIMM FR 24 Colors	

## top

							
powder coating black 1 Colors	powder coating white 1 Colors	powder coating perla 1 Colors	powder coating celeste 1 Colors	powder coating mattone 1 Colors	powder coating caffè 1 Colors	powder coating oliva 1 Colors	powder coating tortora 1 Colors

**consult the portfolio for the range of colors, fabrics, eco-leather, soft-leather.**

### use and maintenance instructions

Clean all parts in wood, leather, fabric and metal with a damp cloth or a diluted neutral cleaner. Do not use cleaners with alcohol, bleach, solvent or abrasive products. Any liquid spilt on the product must be wiped up immediately. When lifting or moving the product, hold it on the structure and not under the seat. The product should not be subjected to unbalanced weights, as it is designed for a proper rest on the foothold (on four legs or on the base). Our company relieves from any responsibility in case of damage caused to fragile floors. Avoid any improper use of the product: do not step on the product, on the footrest or on the armrests. Avoid any movements that could compromise the proper functionality of the product or the safety of the users. Wood and leather, being natural materials, could be easily damaged. Small impurities or imperfections are within quality standard range. Do not expose the product to weather conditions or atmospheric agents, nor to heat sources over 40°C. Also products for outdoor use could be afflicted by atmospheric agents. The product could undergo possible exterior changes due to particular exposure to heat, humidity and saltiness. An appropriate and frequent maintenance and cleaning of the product enhances its durability. The product could change colour and shade, if exposed to direct sunlight. Maintenance has to be carried out by experienced staff. Dispose of the package only after assembling the product, in order to avoid the loss of ironmongery and components. Once the product has been dismantled, the product itself or its components must be given to the public garbage disposal system, according to the legislation in force.