

# Wilkhahn

Occo. 222 range.

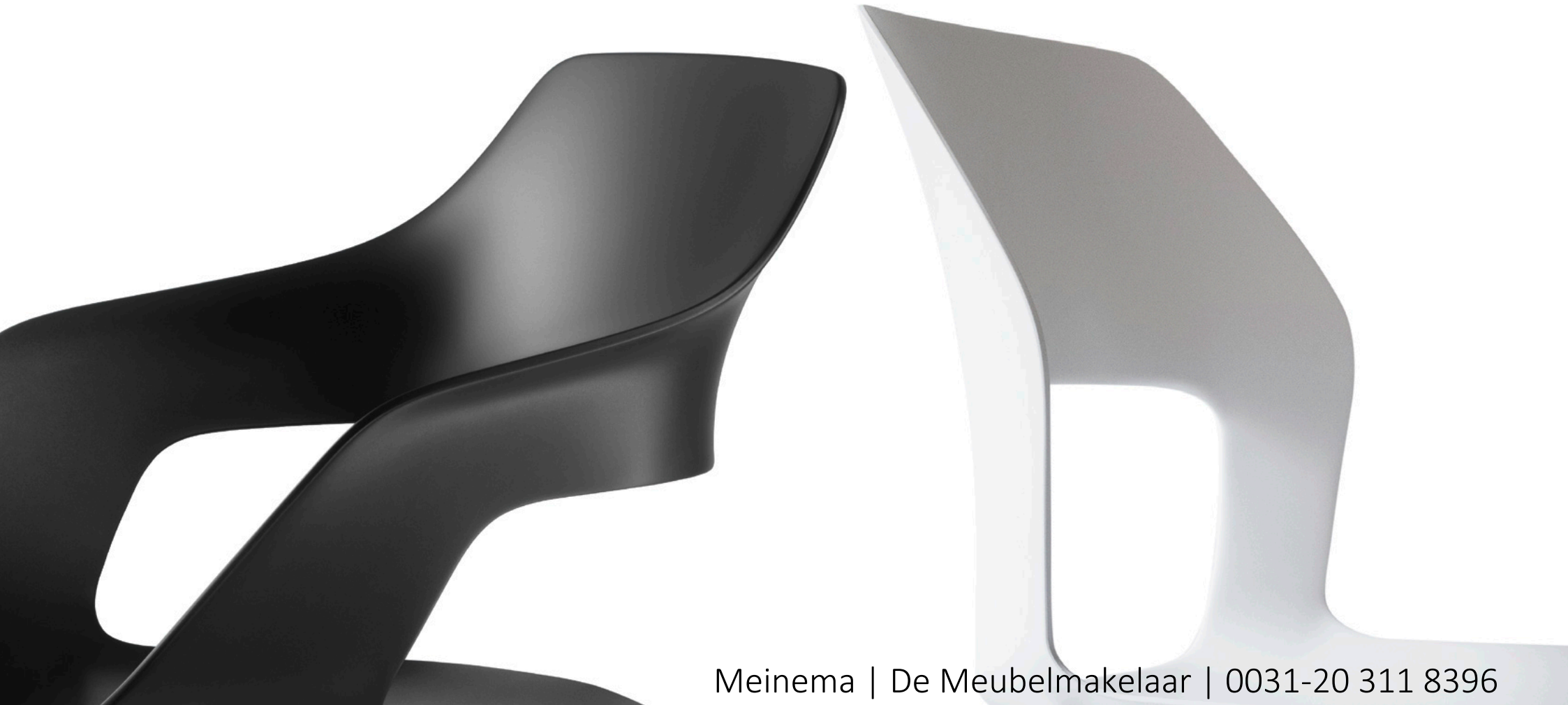

Meinema | De Meubelmakelaar | 0031-20 311 8396



## Occo.

When furnishing contemporary workspaces, one of the biggest challenges is to ensure that the design of the different areas varies but that a common theme prevails throughout. Occo is more than equal to the task due to the precise shape of its seat shells and striking open sections in the backrests. These not only give the chair an airy, light appearance and outstanding comfort, but lend all members of the family a distinctive look.

Two seat shell shapes in six colors and four upholstered types combined with four choices of frame result in 192 different chairs. The range is complemented by bar stools in six colors, two upholstered types and two frames in two heights as well as matching tables. As a result, Occo is an enormously versatile “chair kit” that allows a whole host of design options for furnishing cafés and bistros, to seminar and multipurpose spaces, to meeting areas and conference rooms.



















# Occo. 222 range. Technical details.

# Wilkhahn

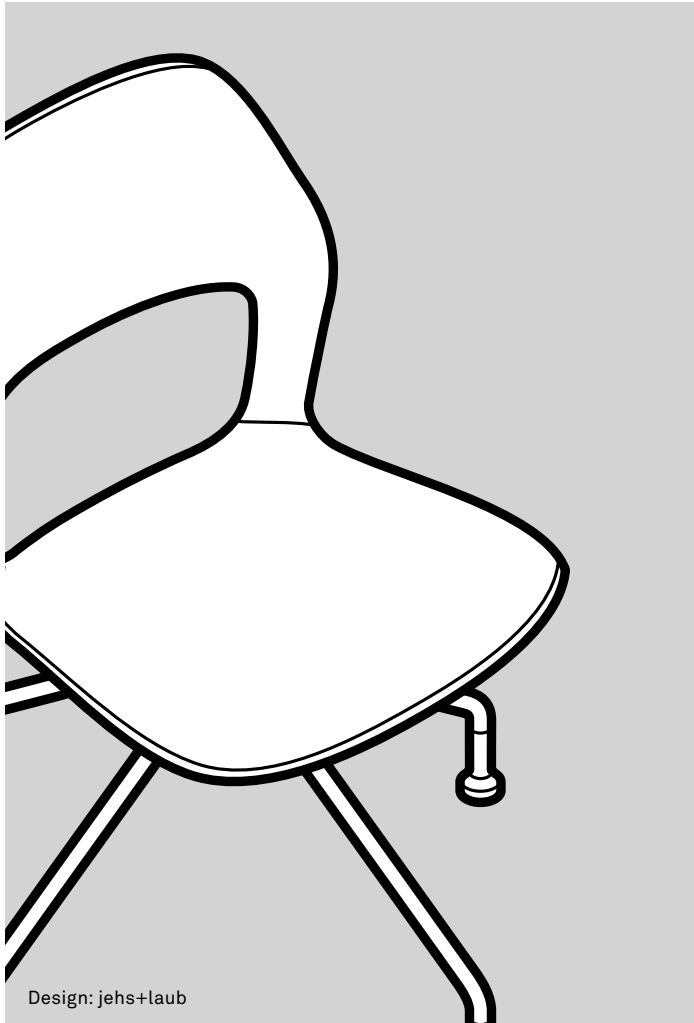

Design: jehs+laub

## Function

In conference rooms, open-plan meeting areas or company restaurants: Occo offers superior comfort, enormous versatility and a vast range of design options in a distinctive design language.

## Chairs

### Frame

#### Four-leg frame models 221/10, 221/11, 221/12, 222/10, 222/11, 222/12

Tubular steel frame with textured matt finish coated in white, black, grey, grey-beige, orange-red, blue-grey or bright chrome-plated. Please note: Coated frame versions are not stackable. Models 221/10 and 222/10 (shell not upholstered) with four separators made of PUR and frame cover made of plastic (PP) each in dark grey. Models 221/11, 221/12, 222/11 and 222/12 with stacking guard made of plastic (PP) in dark grey.

#### Four-leg frame models in solid wood 221/20, 221/21, 221/22, 222/20, 222/21, 222/22

Seat bearer made of tubular steel in dark grey with a textured matt finish to fit onto the seat shell and to attach the four legs made of solid oak with a natural oiled finish.

#### Four-star base models 221/30, 221/31, 221/32, 222/30, 222/31, 222/32, five-star base models 221/40, 221/41, 221/42, 222/40, 222/41, 222/42

Butted tubular steel frame with a textured matt finish coated in white, black, grey, grey-beige, orange-red, blue-grey or bright chrome-plated with seat bearer made of moulded flat steel in dark grey with a textured matt finish to attach to the shell. The four-star base comes with steel glides in dark grey with a textured matt finish. The four-leg and four-star base models come with multipurpose glides for soft and hard floorings. For sensitive flooring, please order with extra felt glides (at no additional charge). Five-star base models 221/40, 221/41, 221/42, 222/40, 222/41, 222/42 with twin wheel swivel castors with load-dependent braking, made of black polypropylene compliant with DIN EN 12529 as the standard version for carpets, optionally with grey polyurethane tyre for hard floors.

## Seat and backrest

Unitary, ergonomically moulded seat shell with cut-out section, made of reinforced through-dyed polypropylene optionally in white, black, grey, grey-beige, orange-red or blue-grey. Models 221/10, 221/20, 221/30, 221/40, 222/10, 222/20, 222/30, 222/40 optionally with felt seat cushion with anti-slip coating. In a light mottled hue, anthracite, graphite, mango, verde, deep water. Models 221/11, 221/21, 221/31, 221/41, 222/11, 222/21, 222/31, 222/41 with seat cushion and models 221/12, 221/22, 221/32, 221/42, 222/12, 222/22, 222/32, 222/42 with padding on the inside made of cut foam in each case.

## Standards

The multipurpose Occo chairs with four-leg frames comply with the DIN EN 16139-L1 office chair standard.



www.tuv.com  
ID 1000000000



## Please note

To ensure quality is maintained we do not offer white leather (74/72). All other standard leather colours are possible.

When exposed to ultra violet rays for long periods of time, the colours of plastics can change slightly.

Due to the nature of the material, there are slight differences in the colour between white table tops with bonded surfaces and HPL table tops and the white Occo plastic chairs.



# Occo BS. 222 range. Technical details.

# Wilkhahn

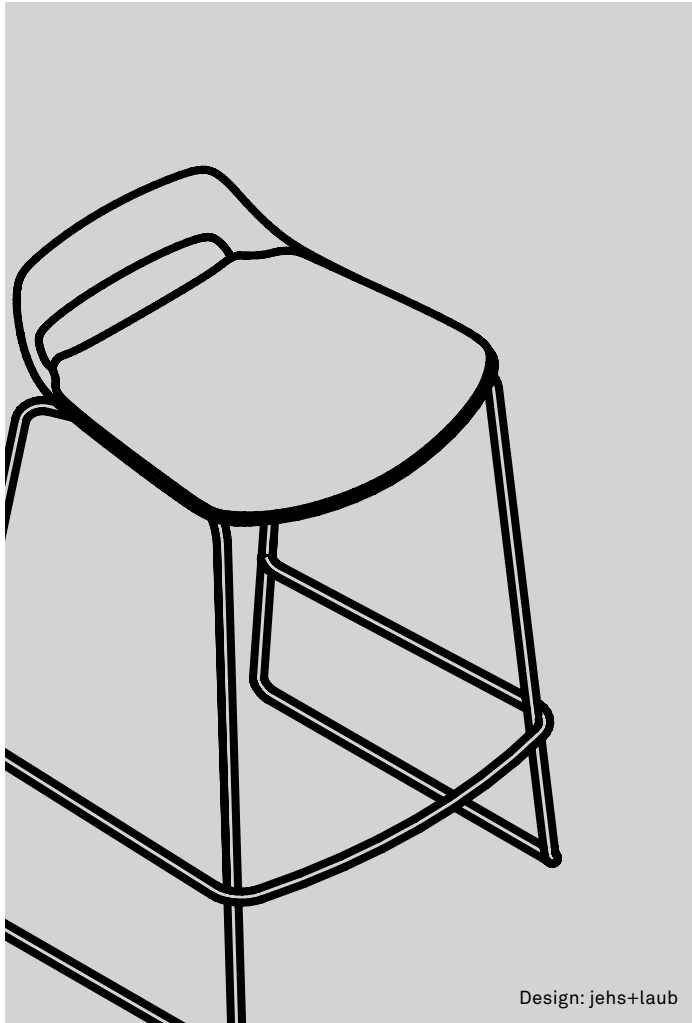

Design: jehs+laub

## Function

In conference rooms, open-plan meeting areas or company restaurants: Occo offers superior comfort, enormous versatility and a vast range of design options in a distinctive design language.

## Chairs

### Frame

### Seat and backrest

Unitary, ergonomically moulded seat shell with cut-out section, made of reinforced through-dyed polypropylene optionally in white, black, grey, grey-beige, orange-red or blue-grey. Models 221/10, 221/20, 221/30, 221/40, 222/10, 222/20, 222/30, 222/40 optionally with felt seat cushion with anti-slip coating. In a light mottled hue, anthracite, graphite, mango, verde, deep water. Models 221/11, 221/21, 221/31, 221/41, 222/11, 222/21, 222/31, 222/41 with seat cushion and models 221/12, 221/22, 221/32, 221/42, 222/12, 222/22, 222/32, 222/42 with padding on the inside made of cut foam in each case.

## Standards

The multipurpose Occo chairs with four-leg frames comply with the DIN EN 16139-L1 office chair standard.



www.tuv.com  
ID 1000000000



## Please note

To ensure quality is maintained we do not offer white leather (74/72). All other standard leather colours are possible.

When exposed to ultra violet rays for long periods of time, the colours of plastics can change slightly.

Due to the nature of the material, there are slight differences in the colour between white table tops with bonded surfaces and HPL table tops and the white Occo plastic chairs.

# Occo. 222 range. Technical details.

# Wilkhahn

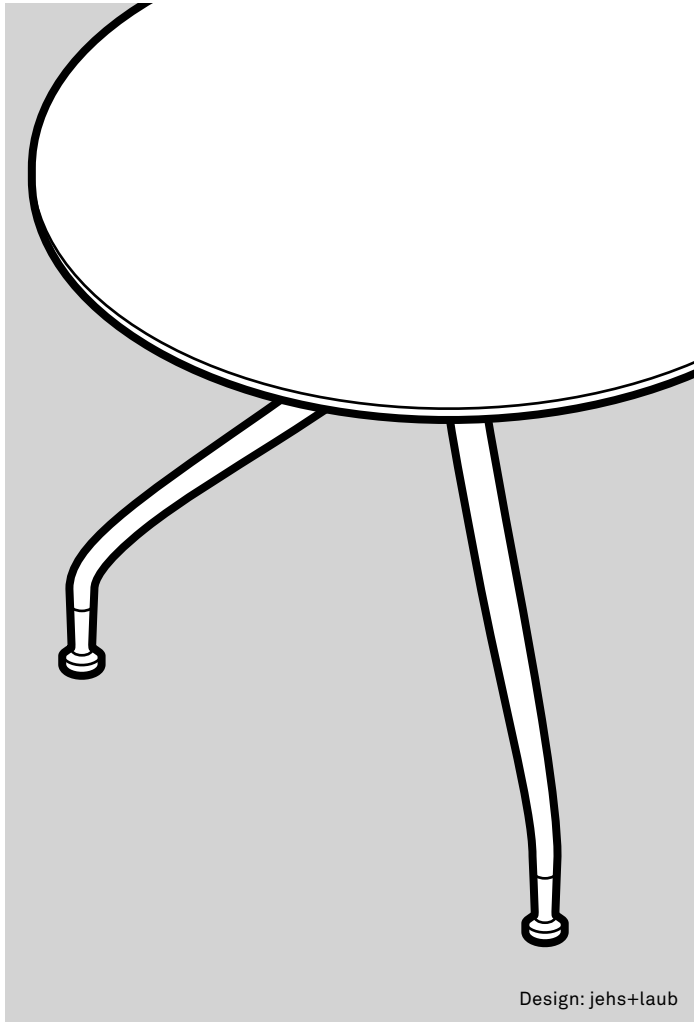

Design: jehs+laub

## Tables

### Frame

Models 222/60 and 222/70 with four star-shaped table legs made of butted tubular steel, optionally with a textured matt finish coated black or white or bright chrome-plated. Models 222/80 and 222/90, table legs connected with a crossbeam. Models as of 90 x 180 incl. extra reinforcement uprights in dark grey textured matt finish. All table top bearers and glides made of steel in dark grey with a textured matt finish. All tables are fitted with multi-purpose glides for soft and hard floorings. In the case of wooden floorings (e.g. parquet) please order with extra felt glides (at no additional charge). Adjustment range: 10 mm. Optionally with lockable, height-adjustable, swivel castors with a black polyamide tyre as the standard version for carpeted floors; castors available with a polyurethane tyre for hard floors (please specify when ordering).

### Core panels on table top, table top group 2 – veneer variant 1 and 2

MDF (medium density fibre-board), table top thickness 26 mm  
Variant 1: Beech or oak veneer from the Wilkhahn woodstain colour samples with chamfered wood lipping, as far as possible in the same colour as the veneer  
Variant 2: Walnut or elm veneers from the Wilkhahn woodstain colour samples with chamfered wood lipping, colour matched as far as possible with the veneer. Table height 74.4 cm

### Table top group 5 – with bonded surface

Table top thickness 25 mm, bonded melamine resin, with bonded surface in white or black with straight plastic lipping colour matched with the surface. Table height 74.3 cm

### Table top group 7 - black/white through-dyed

Table top thickness 12 mm, table top made of through-dyed HPL (High Pressure Laminate) in black or white, chamfered lipping. Table height 73 cm

### Table top group 10 – solid wood

Table top thickness 25 mm, solid oak based on the Wilkhahn woodstain colour samples, natural oiled finish, lipping, rounded on the bottom. Table height 74.3 cm

### Please note

Due to the nature of the material, there are slight differences in the colour between white table tops with bonded surfaces and HPL table tops and the white Occo plastic chairs.

## Edge profiles



E4 – 1 solid wood edge, rounded on the bottom



E2 – 3 Straight plastic edging



E2 – 5 Chamfered wood edging, 12mm

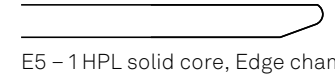

E5 – 1 HPL solid core, Edge chamfered, 4 mm radius



# OCCO. 222 range. Product types.

Wilkhahn



222/10  
Multipurpose chair



221/10  
Multipurpose chair



223/10  
Bar stool



223/20  
Bar stool

# OCCO. 222 range. Upholstery types.

# Wilkhahn



222/10 Multipurpose chair not upholstered



222/11 Multipurpose chair with seat cushioning



222/12 Multipurpose chair with padding on the inside



222/10 Multipurpose chair with felt cushion

### Upholstery material (not all upholstery materials apply to all types)

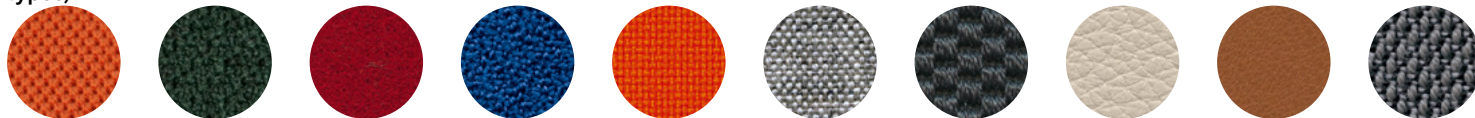

37 Racer | 54 Pitch | 60 Blend | 63 Auris | 66 Lona | 68 Kvadrat Remix 2 | 69 Granite | 74 Leather | 87 Leather | 91 Kvadrat Steelcut Trio 3  
You can find all upholstery materials and more colors in our media center.

The digital sample colors differ from the originals.



# OCCO. 222 range. Frame types.

# Wilkhahn

## Four-leg frame



**222/10** Multipurpose chair  
Frame coated, not stackable



**222/10** Multipurpose chair  
Bright chrome-plated frame, stackable

## Four-star base frame



**222/30** Visitor chair  
Frame coated, swivel-mounted, not stackable



**222/30** Visitor chair  
Bright chrome-plated frame, swivel-mounted, not stackable

## Five-star base frame on castors



**222/40** Task chair  
Frame coated, swivel-mounted, not stackable



**222/40** Task chair  
Bright chrome-plated frame, swivel-mounted, not stackable



**222/20** Multipurpose chair  
Solid wood frame, not stackable

## Frame surfaces, seat and backrest shell

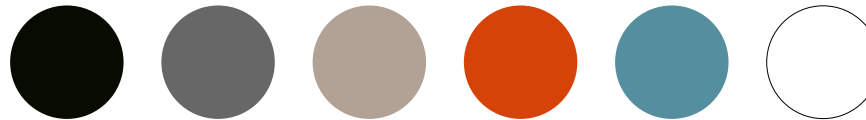

Black, grey, grey-beige, orange-red, blue-grey or white, textured matt finish

The digital sample colors differ from the originals.  
You can find our current fabric collection in our media center.

## Additional frame surfaces



Bright chrome-plated tubular steel or solid oak

# Occo table. 222 range. Product types.

## Wilkhahn

### Shapes

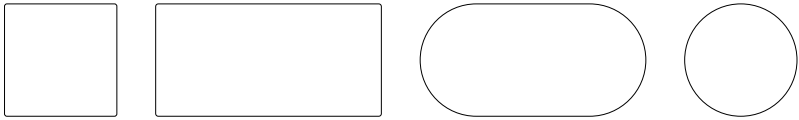

Square: 90 x 90 cm (35 $\frac{3}{8}$ " x 35 $\frac{3}{8}$ " ). Rectangular: 80/90 x 160/190 cm (31 $\frac{1}{4}$ "/35 $\frac{3}{8}$ " x 63" x 74 $\frac{3}{4}$ " ).  
 Oval: 90 – 180/200 cm (35 $\frac{3}{8}$ " – 70 $\frac{7}{8}$ "/78 $\frac{3}{4}$ " )  
 Round: Ø 100 cm (39 $\frac{3}{8}$ " ).  
 Height: depending on the table top material 73.0 – 74.4 cm (28 $\frac{3}{4}$ " – 29 $\frac{1}{4}$ " )

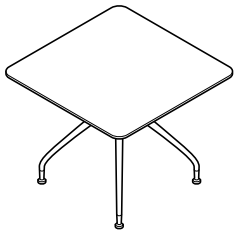

222/60 Square

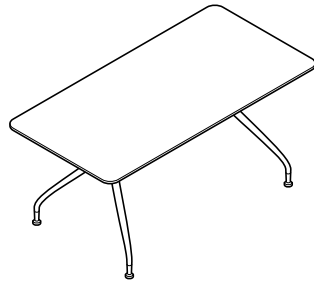

222/80 Rectangular

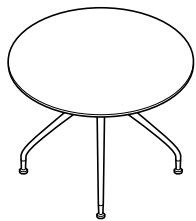

222/70 Round

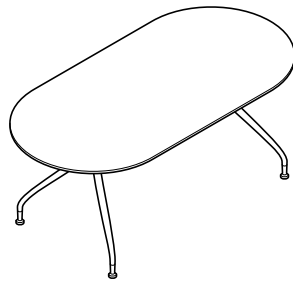

222/90 Oval





# Occo table. 222 range. Product types.

# Wilkhahn



Solid oak table tops, 25 mm thick, edge rounded on the bottom



Black through-dyed HPL (High Pressure Laminate) table tops, 12 mm thick, chamfered edge

### Table top groups



Direct coating, through-dyed black/white, veneer version 1 or 2, solid wood, you can find further surfaces in our media center

### Edge profiles



Solid wood edge, rounded on the bottom, plastic liping straight, chamfered wood edge or HPL solid core, chamfered edge

The digital sample colors differ from the originals.

# Occo table. 222 range. Frame types.

Wilkhahn

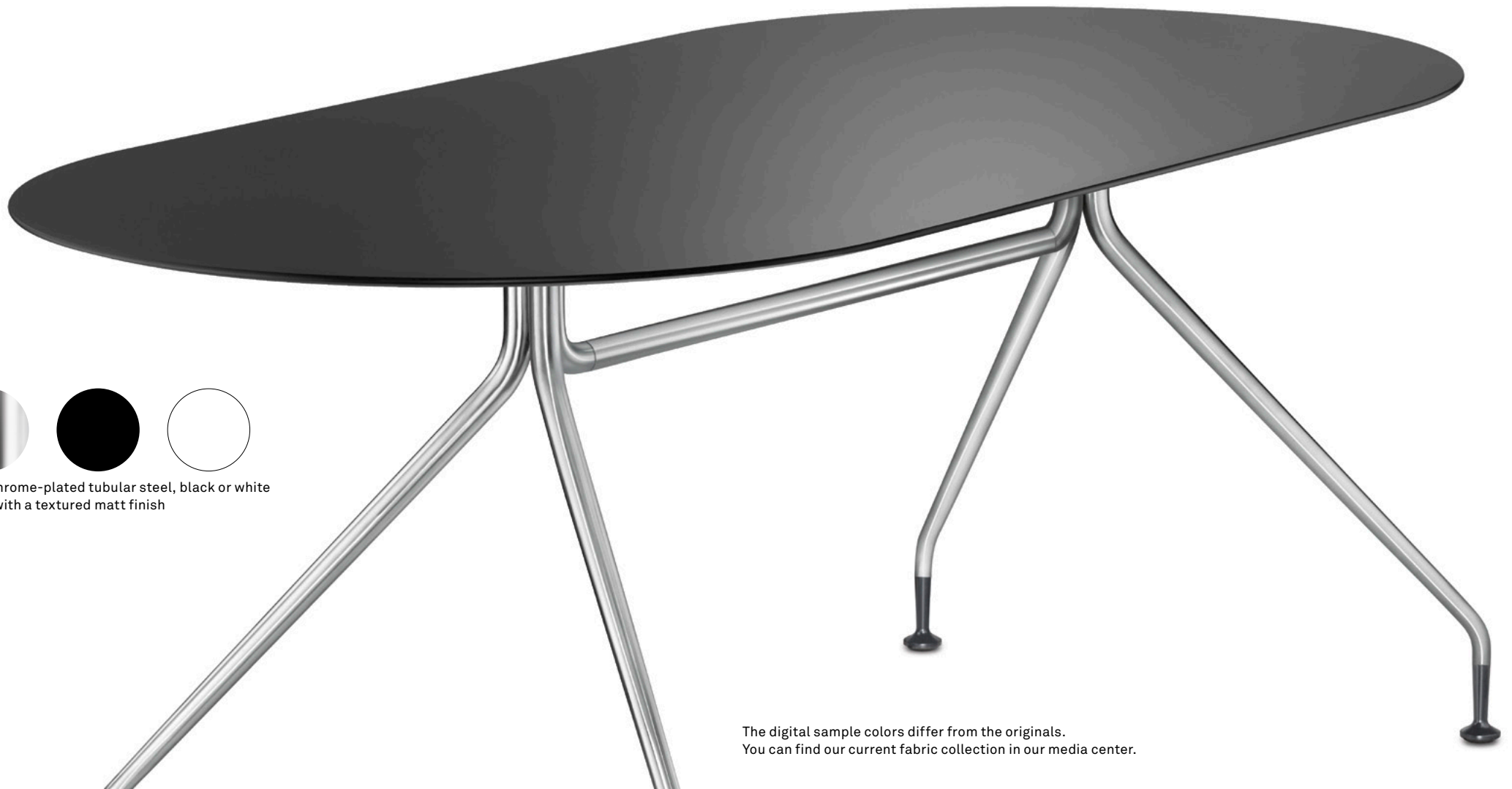

Bright chrome-plated tubular steel, black or white coated with a textured matt finish

The digital sample colors differ from the originals.  
You can find our current fabric collection in our media center.

# OCCO. 222 range. Accessories and other items.

Wilkhahn

## Felt cushions

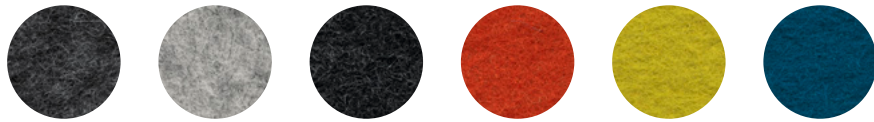

Anthracite, light mottled, graphite, mango, verde, deep water



**222/11**  
Multipurpose chair,  
with seat cushioning  
up to 6 are stackable

The digital sample colors differ from the originals.



# Occo. 222 range. Models and dimensions.

# Wilkhahn

## 222/10

Multipurpose chair

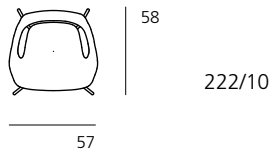
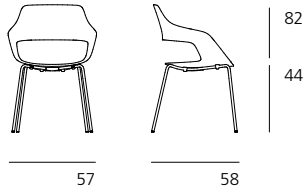

## 222/11

Multipurpose chair

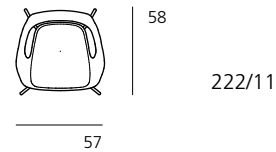
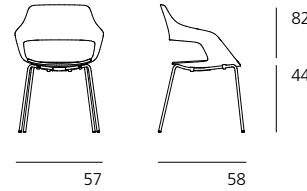

## 222/12

Multipurpose chair

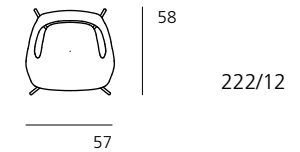
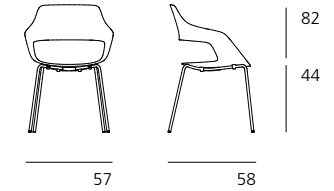

## 222/20

Multipurpose chair

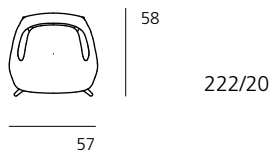
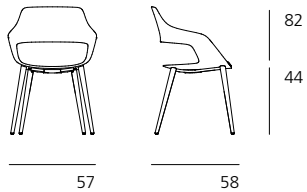

## 222/21

Multipurpose chair

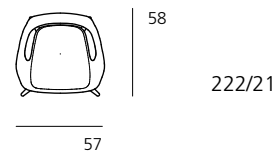
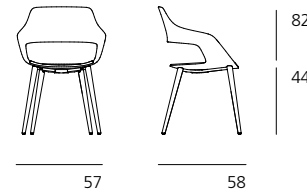

## 222/22

Multipurpose chair

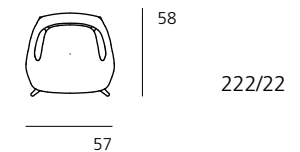
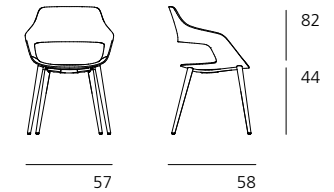

# Occo. 222 range. Models and dimensions.

# Wilkhahn

## 222/30

Multipurpose chair

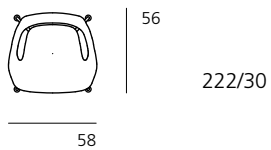
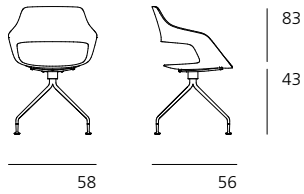

222/30

## 222/31

Multipurpose chair

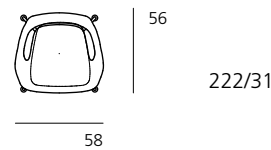
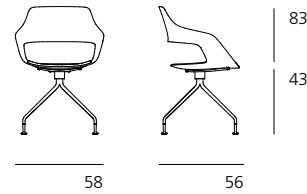

222/31

## 222/32

Multipurpose chair

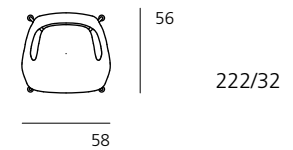
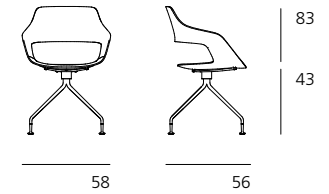

222/32

## 222/40

Multipurpose chair

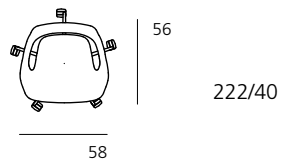
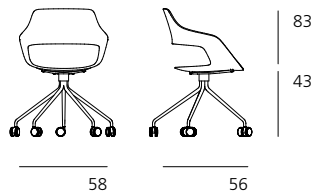
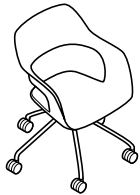

222/40

## 222/41

Multipurpose chair

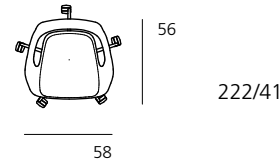
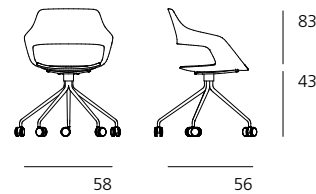

222/41

## 222/42

Multipurpose chair

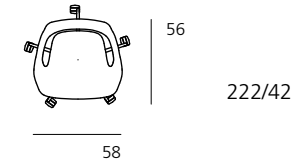
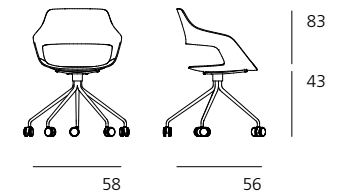

222/42

# OCCO. Models and dimensions.

# Wilkhahn

**221/10**  
Multipurpose chair

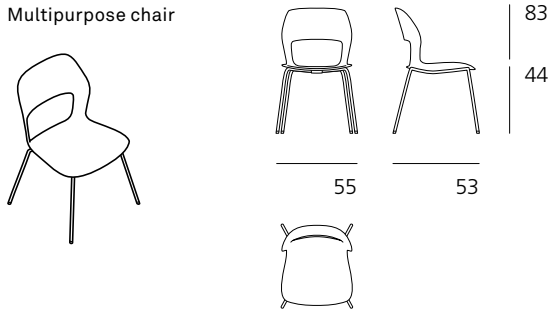

**221/11**  
Multipurpose chair



**221/12**  
Multipurpose chair



**221/20**  
Multipurpose chair

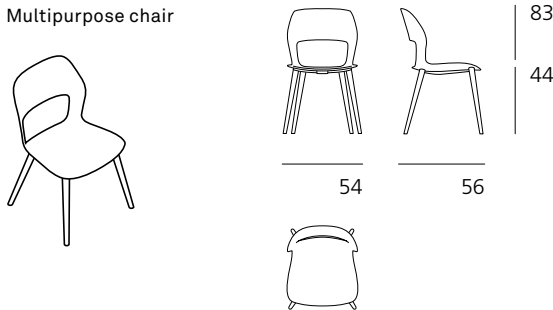

**221/21**  
Multipurpose chair



**221/22**  
Multipurpose chair





# OCCO. Models and dimensions.

# Wilkhahn

**221/30**  
Multipurpose chair

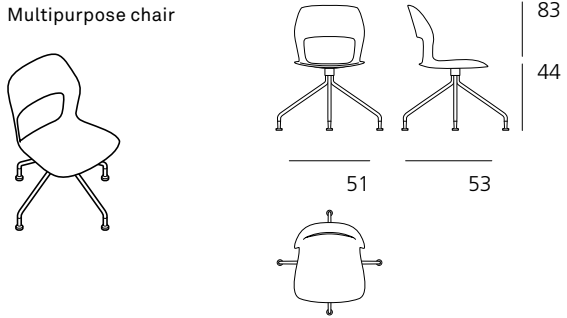

**221/31**  
Multipurpose chair



**221/32**  
Multipurpose chair



**221/40**  
Multipurpose chair

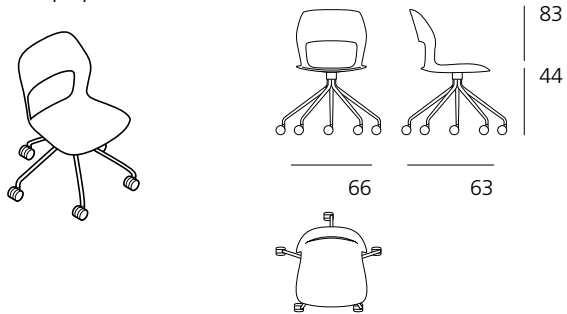

**221/41**  
Multipurpose chair



**221/42**  
Multipurpose chair



# OCCO. Models and dimensions.

# Wilkhahn

**223/10**  
Counter/bar stool

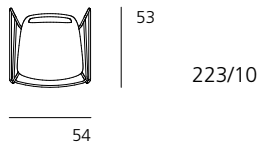
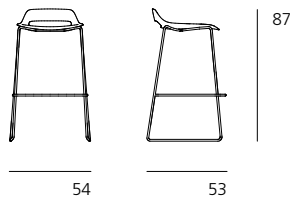
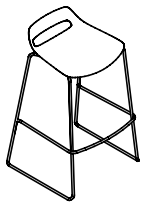

**223/10**  
Counter/bar stool

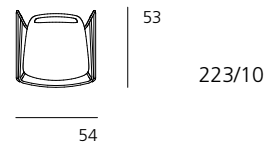
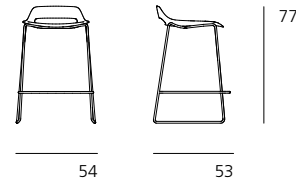
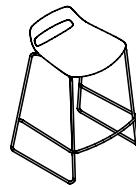

**223/11**  
Counter/bar stool

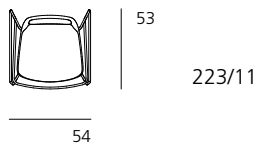
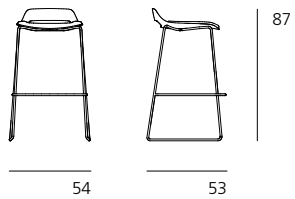
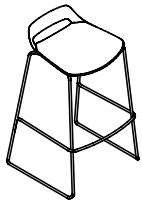

**223/11**  
Counter/bar stool

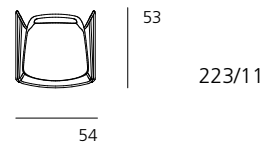
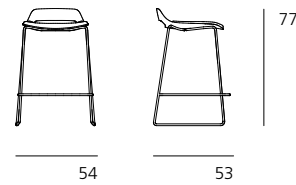
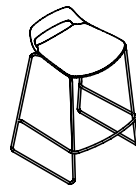

# OCCO. Models and dimensions.

# Wilkhahn

**223/20**  
Counter/bar stool

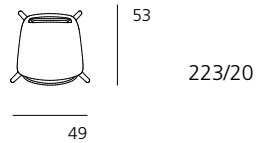
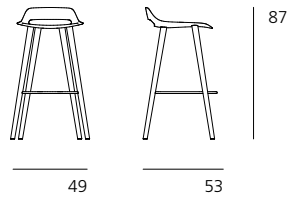

**223/20**  
Counter/bar stool

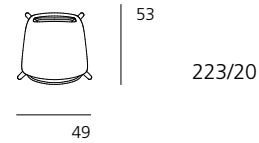
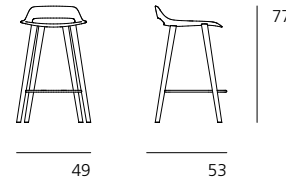
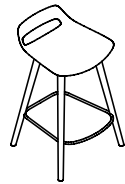

**223/21**  
Counter/bar stool

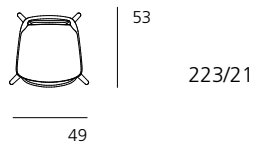
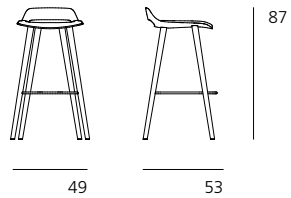

**223/21**  
Counter/bar stool

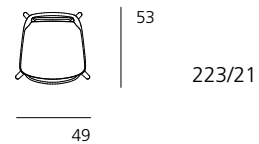
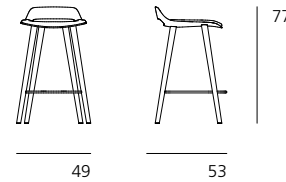



# Occo table. 222 range. Models and dimensions.

# Wilkhahn

**222/60**  
Square

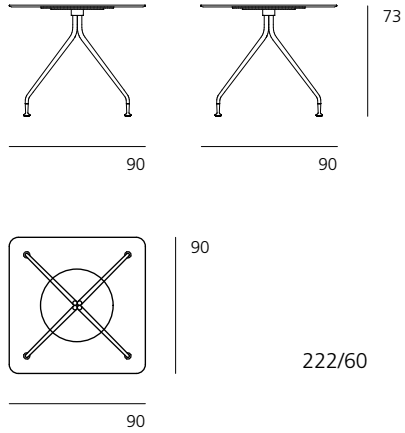
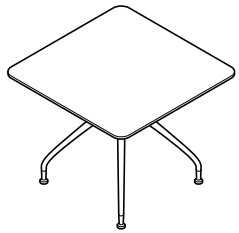

**222/70**  
Round

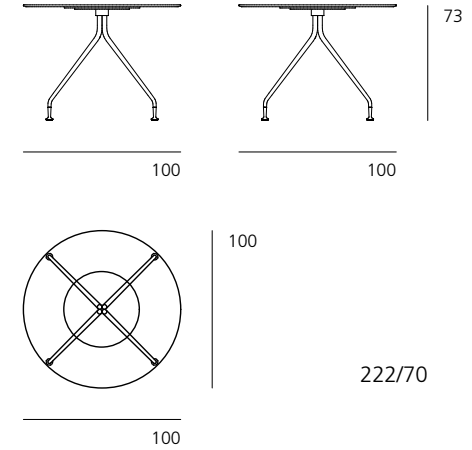
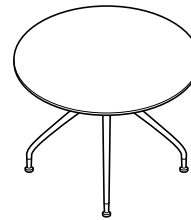

**222/80**  
Rectangular

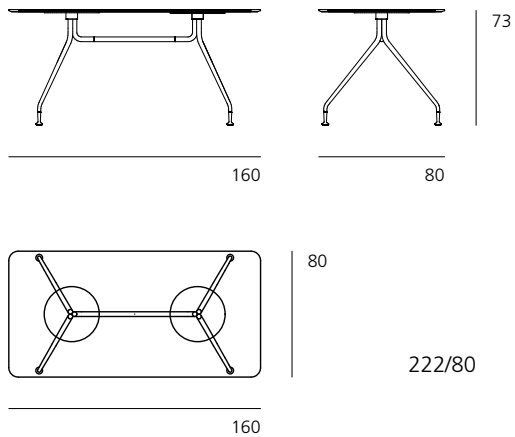
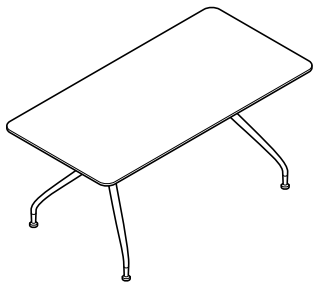

**222/90**  
Oval

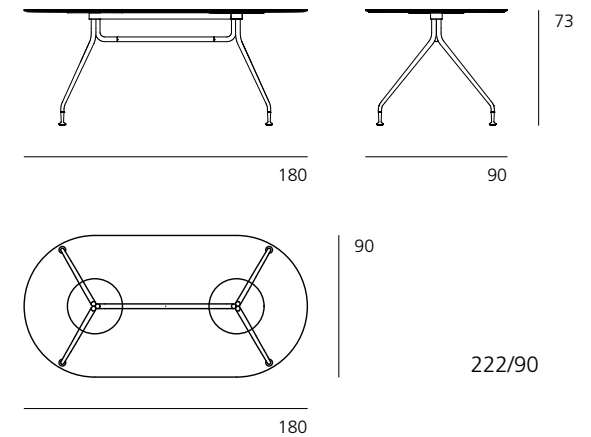
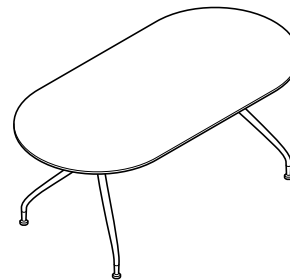

# Occo. 222 range. Awards / standards / certificates.

# Wilkhahn

## Awards



Not all awards apply to all types.

## Product certificates / product standards



Not all certificates / standards apply to all types.

## Company's certificates, memberships

