

Collection 2021

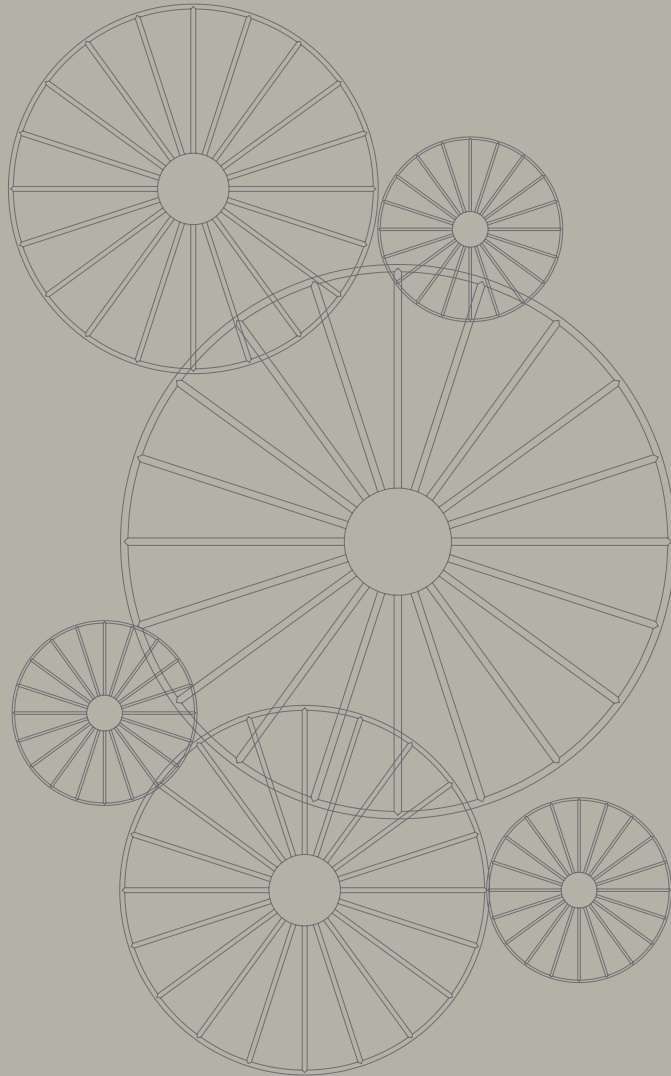

aromas

Meinema | De Meubelmakelaar | 0031 - 20 311 8396

Behaviours

En Aromas del Campo comenzamos nuestra andadura como sociedad en 1986, en Valencia. En aquel entonces nuestra especialidad era la fabricación de potpourris de flores secas y productos aromáticos. Unos años más tarde comenzamos a fabricar pequeños sobremesas de cristal rellenos de flores secas. Desde entonces, y una vez consolidados en el sector de la iluminación, trasladamos nuestra actividad a la población de Bétera (Valencia), desde donde centralizamos la producción y distribución internacional de nuestros productos de iluminación.

Apostamos por un diseño tecnológico, funcional y asequible, con líneas puras y sencillas pero sin descuidar la forma. En esta

colección ponemos el foco en materiales tradicionalmente relegados a los acabados constructivos y a los complementos de la decoración, como son el mármol, la madera o la cerámica. Sin embargo, nuestros materiales principales continúan siendo el metal y el cristal combinados en un juego de solidez y ligereza que resulta en piezas elegantes y atemporales.

Este año ofrecemos una visión más humana, más cercana e intimista, **Behaviours Around Light**, es un concepto que recrea las sensaciones y comportamientos alrededor de nuestras lámparas. Los ambientes, la luz, la atmósfera y las personas.

In Aromas del Campo we began our journey as a company in 1986, in Valencia. At that time our specialty was the manufacturing of potpourris of dried flowers and aromatic products. A few years later we started to make small glass table lamps filled with dried flowers. Since then, and once consolidated in the lighting sector, we moved our activity to the town of Bétera (Valencia), where we centralized production and international distribution of our lighting products.

We bet on technological design, functional and affordable lamps, with pure and simple lines but without neglecting the forms of Aromas. In this collection we focus on tradi-

tionally relegated materials to the construction finishes and decorative complements, such as marble, wood or ceramic. However, our main materials continue to be metal and glass, combined in a diversion of solidity and lightness that results in elegant and timeless pieces.

This year we wanted to offer a more human, closer and more intimate vision, **Behaviours Around Light**, is a concept that recreates the sensations and behaviors around our lamps. The environments, the light, the atmosphere and the people.

around light



4
Table lamps
Sobremesas

116
Pendants
Colgantes

220
Floor lamps
Pies

268
Wall lamps
Apliques

362
Accessories
Accesorios

366
Bulbs
Bombillas

372
Finishings
Acabados

376
General conditions
Condiciones generales

379
Icons
Iconos

Table lamps

6	KINE	46	LIND	84	ONA
9	FITO	48	ATOM	86	TORNO
10	TANT	50	SUN LIGHT	87	TEX
11	AMBOR	51	DOBI	88	ENA
14	HUP	52	CHATEAU	89	BOYA
16	ATIL	55	MARU	90	ADON
17	FOCUS	56	BOA/LUA	91	HOME
18	ITO	57	DAMO	92	METRIC
19	UNCO	58	LALU	95	SONICA
20	LYB	61	MARBRE	96	ONICA
23	AITO	62	MUSE	97	ATINA
24	ALMON	64	LESS	98	TARO
26	WONG	66	MILA	101	SHADOW
27	ABBACUS	67	ENDO	102	NOA
30	ERTO	70	STAN	105	PONN PONN
31	MAHO	71	HEDULA	106	KITTA KITTA
34	TIVOLI	74	RIU	107	KITTA PONN
35	FICUS	75	PAGO	110	PONN
38	CRANE	76	COHEN/C.GOLD	111	LUSA
39	ALOA	77	SAND	112	MELLY
40	LUCA	78	CAND	115	SAM
43	LOLA	79	ALDA		
44	LITA	82	FUNN		
45	NERA	83	ECLECTIC		

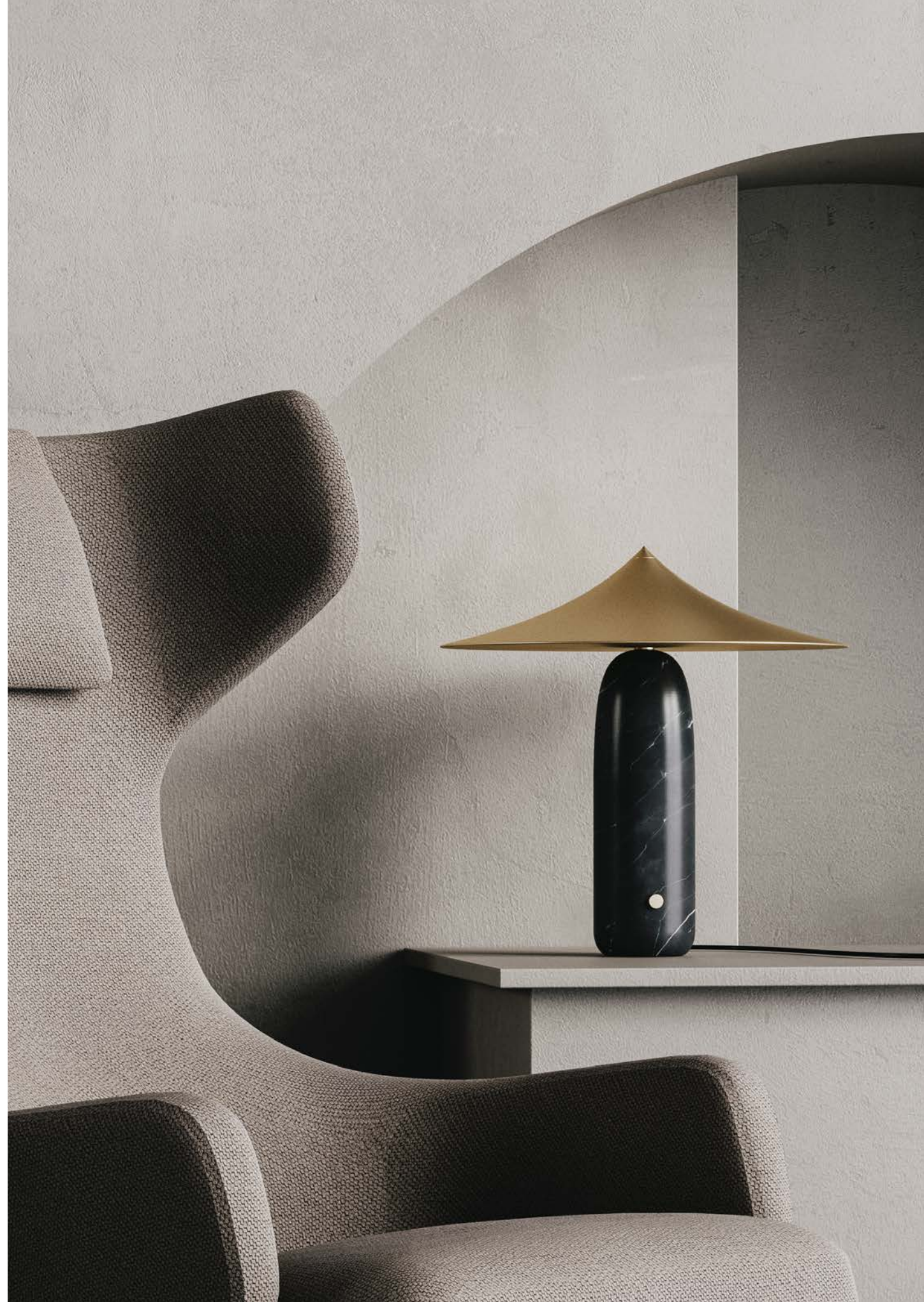



KINE

DESIGNED BY PEPE FORNAS, 2020 · S1288

ES

ACABADOS

Base:
Mármol negro mate
Mármol blanco mate

Tulipa:
Negro texturado
Blanco texturado
Oro mate

MATERIALES

Acero / Mármol

ESPECIFICACIONES (UE)

Placa LED integrada 10W
3000K 24V, 50/60Hz
IP20, Clase II
Touch Me Regulable



CLASIFICACIÓN ENERGÉTICA

A ++

EN

FINISHES

Base:
Matt Black Marble
Matt White Marble

Shade:
Textured Black
Textured White
Matt Brass

MATERIALS

Steel/Marble

SPECIFICATIONS (UE)

Integrated LED plate 10W
3000K 24V, 50 / 60Hz
IP20, Class II
Touch Me Dimmer



ENERGY LABEL

A ++

TEC

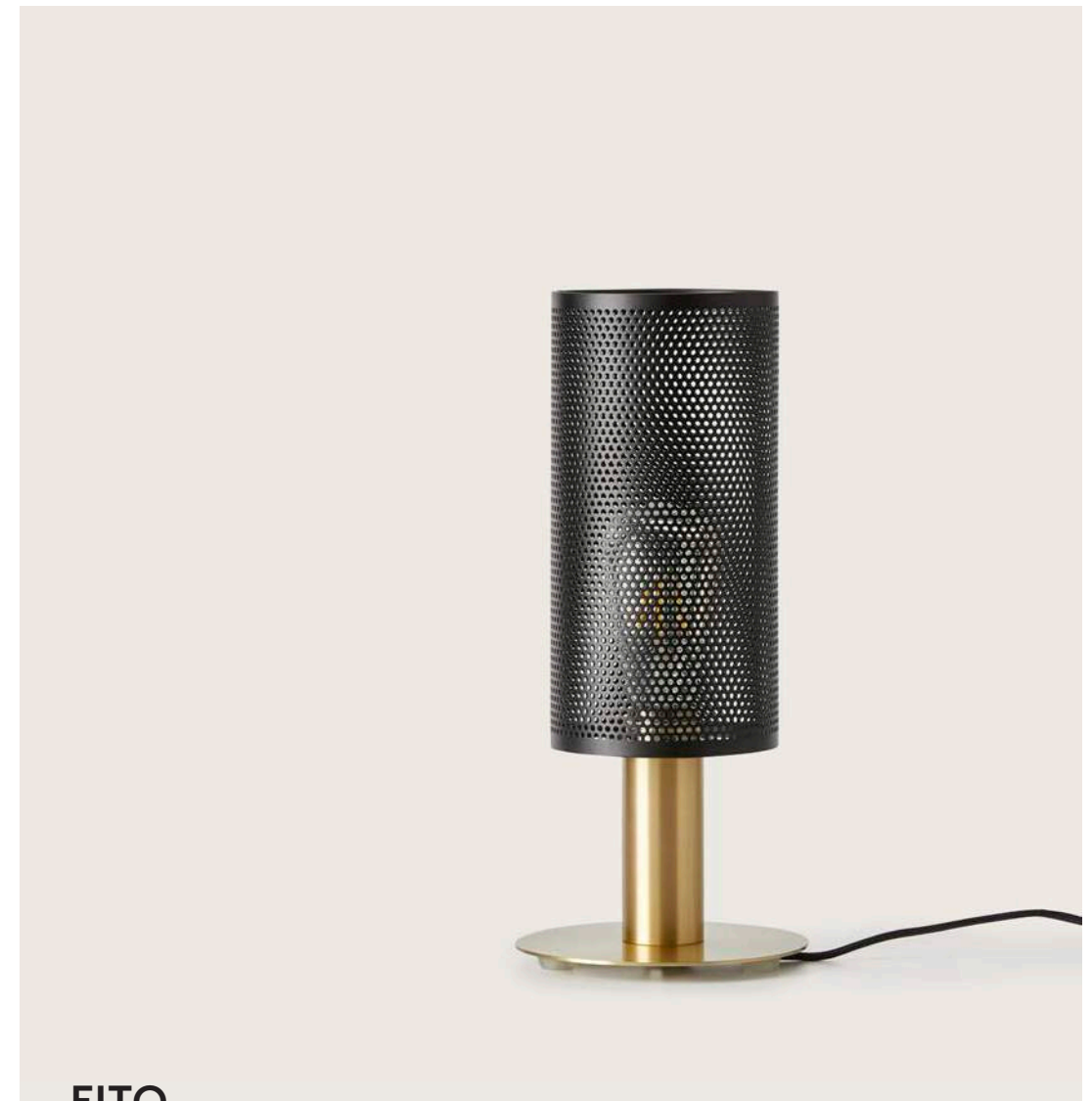
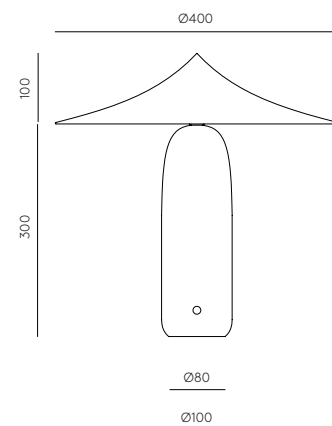

FITO

DESIGNED BY PEPE FORNAS, 2020 · S1286/25

ES

ACABADOS

Base:
Oro Mate
Oro Mate

Rejilla:
Negro Mate
Blanco Mate

MATERIALES

Acero

ESPECIFICACIONES (UE)

E27 (Bombilla no incluida)
220-240 V, 50/60 Hz
IP20, Clase II
Regulador en cable



CLASIFICACIÓN ENERGÉTICA

A ++

MODIFICACIONES POSIBLES

Pantalla 50 cm
altura - consultar

BOMBILLA IMAGEN
B050

EN

FINISHES

Base:
Matt Brass
Matt Brass

Rack:
Matt Black
Matt White

MATERIALS

Steel

SPECIFICATIONS (UE)

E27 (Bulb not included)
220-240 V, 50/60 Hz
IP20, Class II
Dimmer on cable



ENERGY LABEL

A ++

POSSIBLE MODIFICATIONS

Shade 50 cm
height - Ask us

BULB IMAGE
B050

TEC

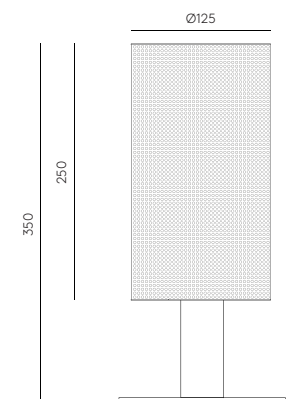



TANT

DESIGNED BY JF SEVILLA, 2020 · S1284

ES

ACABADOS

Metal: Oro Mate
Negro Mate

Ratán: Natural
Natural

MATERIALES

Acero / Ratán

ESPECIFICACIONES (UE)

Tira LED 14W
3000K 24V, 50/60Hz
IP20, Clase II



CLASIFICACIÓN ENERGÉTICA

A ++

EN

FINISHES

Metal: Oro Mate
Negro Mate

Rattan: Natural
Natural

MATERIALS

Steel / Rattan

SPECIFICATIONS (UE)

Led strip 14W
3000K 24V, 50/60Hz
IP20, Clase II



ENERGY LABEL

A ++

TEC

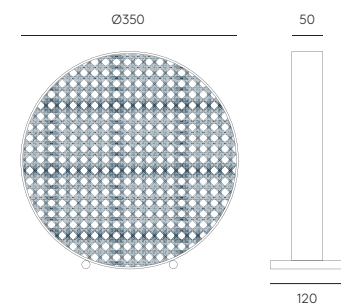

AMBOR

DESIGNED BY JF SEVILLA, 2019 · S1283

ES

ACABADOS

Cuerpo: Negro Mate

Tulipa / Base: Negro Mate
Oro Mate

MATERIALES

Acero

ESPECIFICACIONES (UE)

Bombillas G9 Led Regulables
(Incluidas)
2 x 3W - 3000K
220-240 V, 50/60 Hz
IP20, Clase II
Regulador en cable



CLASIFICACIÓN ENERGÉTICA

A ++

BOMBILLAS INCLUIDAS

B005/3W/REG

EN

FINISHES

Body: Matt Black

Shade / Base: Matt Black
Matt Brass

MATERIALS

Steel

SPECIFICATIONS (UE)

G9 Led Dimmable Bulbs
(Included)
2 x 3W - 3000K
220-240 V, 50/60 Hz
IP20, Class II
Dimmer on cable



ENERGY LABEL

A ++

BULBS INCLUDED

B005/3W/REG

TEC

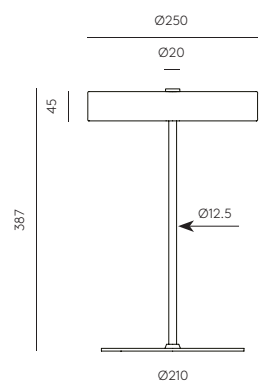





HUP

DESIGNED BY PEPE FORNAS, 2019 · S1282

ES

ACABADOS

Cuerpo:
Negro Mate
Oro Mate
Cromo

Tulipa:
Opal
Opal
Opal

MATERIALES

Acero / Vidrio

ESPECIFICACIONES (UE)

E27 Max. 60W (No incluida)
220-240 V, 50/60 Hz
IP20, Clase II



CLASIFICACIÓN ENERGÉTICA

A ++

BOMBILLA RECPMENDADA

B211 (7, 9, 11W)

EN

FINISHES

Body:
Matt Black
Matt Brass
Chrome

Shade:
Opal
Opal
Opal

MATERIALS

Steel / Glass

SPECIFICATIONS (UE)

E27 Max. 60W (Not included)
220-240 V, 50/60 Hz
IP20, Class II



ENERGY LABEL

A ++

RECOMMENDED BULB

B211 (7, 9, 11W)

TEC

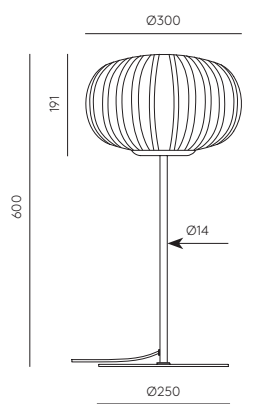



ATIL

DESIGNED BY PEPE FORNAS, 2019 · S1281

ES

ACABADOS

Metal:
Negro Mate
Oro Mate

Tulipa:
Opal
Opal

MATERIALES

Acero / Vidrio

ESPECIFICACIONES (UE)

Bombillas G9 Led (Incluidas)
2 x 5W - 2700K
220-240 V, 50/60 Hz
IP20, Clase II



CLASIFICACIÓN ENERGÉTICA

A ++

BOMBILLAS INCLUIDAS

B005/5W

EN

FINISHES

Metal:
Matt Black
Matt Brass

Shade:
Opal
Opal

MATERIALS

Steel / Glass

SPECIFICATIONS (UE)

Bulbs G9 Led (Included)
2 x 5W - 2700K
220-240 V, 50/60 Hz
IP20, Class II



ENERGY LABEL

A ++

BULBS INCLUDED

B005/5W

TEC

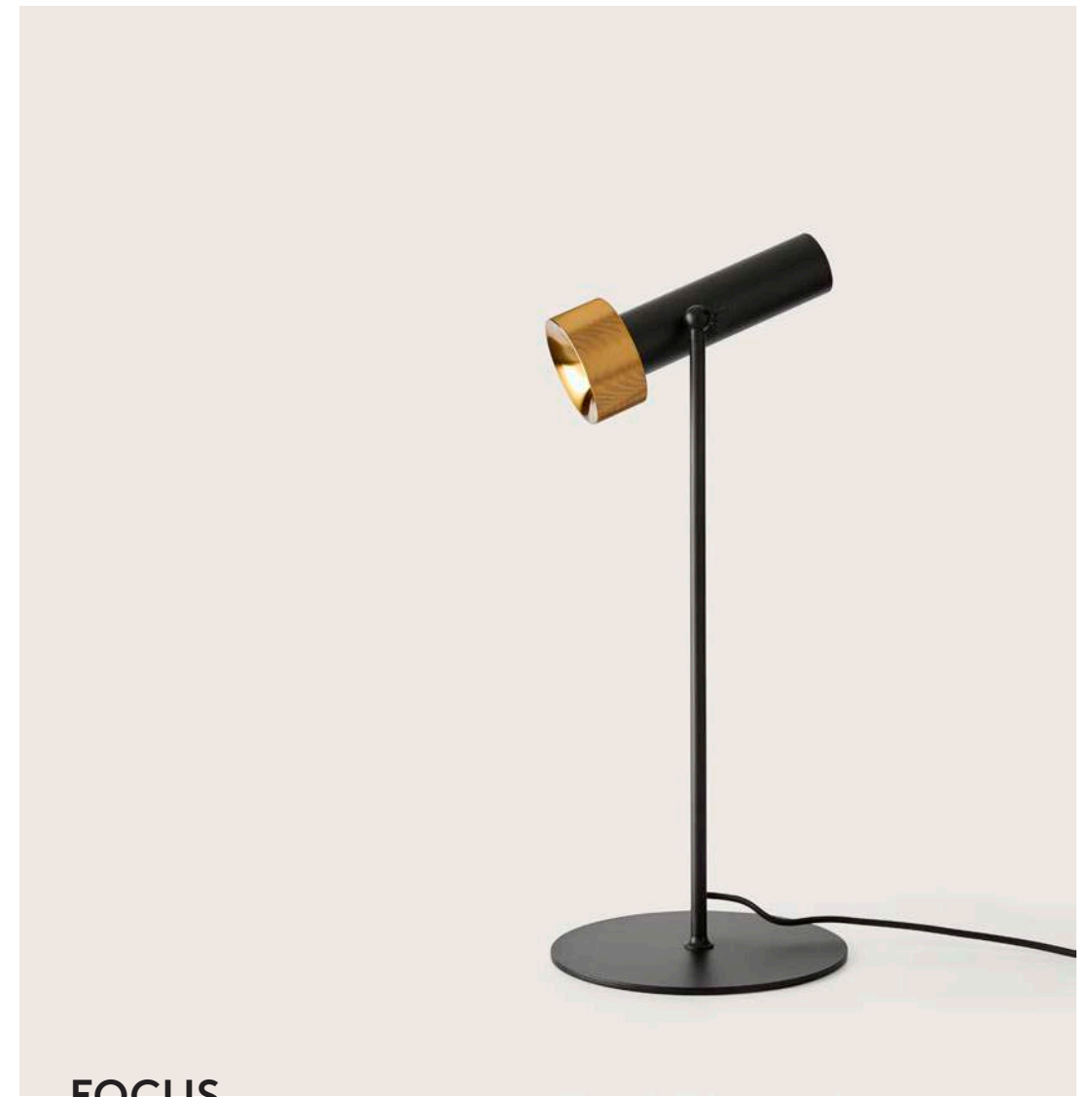
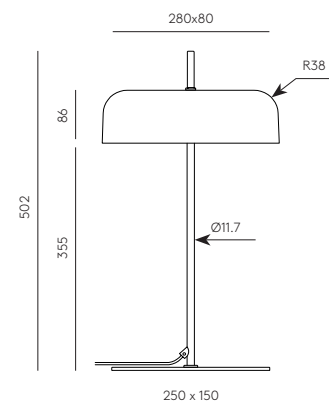

FOCUS

DESIGNED BY PEPE FORNAS, 2019 · S1279

ES

ACABADOS

Cuerpo:
Negro Mate
Negro Mate

Cabeza:
Oro Viejo
Antracita

MATERIALES

Acero / Aluminio

ESPECIFICACIONES (UE)

Bombilla GU10 Led (Incluida)
5W - 3000K
220-240 V, 50/60 Hz
IP20, Clase II



CLASIFICACIÓN ENERGÉTICA

A ++

MODIFICACIONES POSIBLES

Cabezal de alabastro

BOMBILLAS RECOMENDADAS

B161

EN

FINISHES

Body:
Matt Black
Matt Black

Head:
Aged Gold
Anthracite

MATERIALS

Steel / Aluminium

SPECIFICATIONS (UE)

GU10 Led Bulb (Included)
5W - 3000K
220-240 V, 50/60 Hz
IP20, Class II



ENERGY LABEL

A ++

POSSIBLE MODIFICATIONS

Alabaster head

RECOMMENDED BULBS

B161

TEC

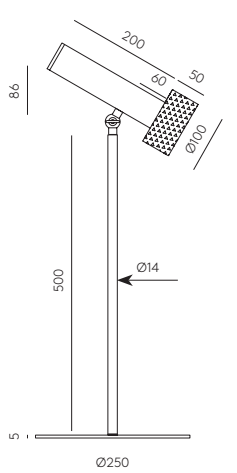



ITO

DESIGNED BY PEPE FORNAS, 2019 · S1277

ES

ACABADOS
Metal: Negro Mate Base: Granito Gris

MATERIALES
Acero / Granito

ESPECIFICACIONES (UE)
E27 Max. 60W (No incluida)
220-240 V, 50/60 Hz
IP20, Clase II



CLASIFICACIÓN ENERGÉTICA
A ++

MODIFICACIONES POSIBLES
Pantalla imagen
801125/35/NEG
Pantalla no incluida
BOMBILLAS RECOMENDADAS
B052

EN

FINISHES
Metal: Matt Black Base: Terrazzo Grey

MATERIALES
Steel / Terrazzo

SPECIFICATIONS (UE)
E27 Max. 60W (Not included)
220-240 V, 50/60 Hz
IP20, Class II



ENERGY LABEL
A ++

POSSIBLE MODIFICATIONS
Recommended shade
801125/35/BLACK
Shade not included
RECOMMENDED BULB
B052

TEC

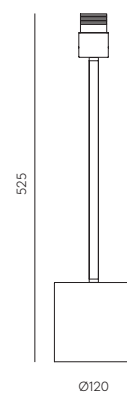

UNCO

DESIGNED BY PEPE FORNAS, 2019 · S1276

ES

ACABADOS
Metal: Negro Mate Cristal: Fumé Gris
Oro Mate Fumé Gris

MATERIALES
Acero / Vidrio

ESPECIFICACIONES (UE)
G9 LED (incluidas)
2 x 5W - 3000K
220-240 V, 50/60 Hz
IP20, Clase II



CLASIFICACIÓN ENERGÉTICA
A ++

BOMBILLAS INCLUIDAS
B005/5W

EN

FINISHES
Metal: Matt Black Glass Shade: Smoked Grey
Matt Brass Smoked Grey

MATERIALS
Steel / Glass

SPECIFICATIONS (UE)
G9 LED (included)
2 x 5W - 3000K
220-240 V, 50/60 Hz
IP20, Class II



ENERGY LABEL
A ++

BULBS INCLUDED
B005/5W

TEC

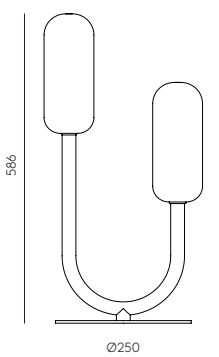





LYB

DESIGNED BY PEPE FORNAS, 2019 · S1274

ES

ACABADOS
Metal:
Negro Mate
Blanco Mate

MATERIALES
Acero

ESPECIFICACIONES (UE)
Chip Led integrado 5W,
3000K
12 V, 50/60 Hz
IP20, Clase II



CLASIFICACIÓN ENERGÉTICA
A ++

TOUCH ME DIMERABLE

EN

FINISHES
Metal:
Matt Black
Matt White

MATERIALS
Steel

SPECIFICATIONS (UE)
Integrated LED chip 5W
3000K
12 V, 50/60 Hz
IP20, Class II



ENERGY LABEL
A ++

TOUCH ME DIMMABLE

TEC

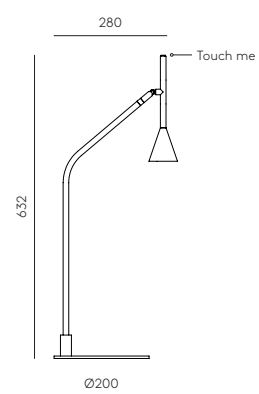

AITO

DESIGNED BY PEPE FORNAS, 2019 · S1270

ES

ACABADOS
Metal:
Negro Mate

Madera:
Nogal

MATERIALES
Acero / Nogal

ESPECIFICACIONES (UE)
E27 Max. 60W (No incluida)
220-240 V, 50/60 Hz
IP20, Clase II



BOMBILLA RECOMENDADA
B211 (7, 9, 11W)

EN

FINISHES
Metal:
Matt Black

Wood:
Walnut

MATERIALS
Steel / Walnut

SPECIFICATIONS (UE)
E27 Max. 60W (Not included)
220-240 V, 50/60 Hz
IP20, Class II



RECOMMENDED BULB
B211 (7, 9, 11W)

TEC

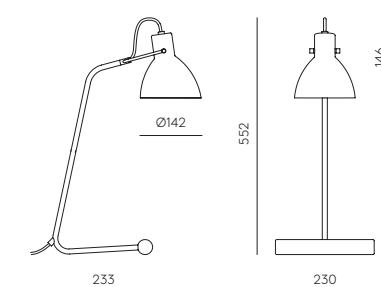



ALMON

DESIGNED BY PEPE FORNAS, 2018 · S1264

ES

ACABADOS
Metal: Negro Mate
 Oro Mate (detalles)
 Piel Marrón
Cristal
 (Incluido):
 Opal

MATERIALES
 Acero / Vidrio Soplado / Cuero

ESPECIFICACIONES (UE)
 G9 Led 5W
 2700K (Incluida)
 220-240 V, 50/60 Hz
 IP20, Clase II



CLASIFICACIÓN ENERGÉTICA
 A ++

BOMBILLA INCLUIDA
 B005/5W

EN

FINISHES
Metal: Matt Black
 Matt Brass (details)
 Brown Leather
Glass Shade
 (Included):
 Opal

MATERIALES
 Steel / Blown Glass / Leather

SPECIFICATIONS (UE)
 G9 Led 5W
 2700K (Included)
 220-240 V, 50/60 Hz
 IP20, Class II



ENERGY LABEL
 A ++

BULB INCLUDED
 B005/5W

TEC

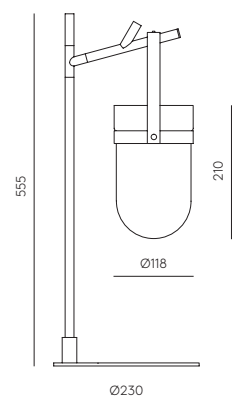



WONG

DESIGNED BY PEPE FORNAS, 2018 · S1263

ES

ACABADOS

Metal: Negro Mate
Piel Marrón

Cristal (Incluido):
Opal

MATERIALES

Acero / Vidrio Soplado / Cuero

ESPECIFICACIONES (UE)

2 x G9 Led - 5W
2700K (Incluidas)
220-240 V, 50/60 Hz
IP20, Clase II



CLASIFICACIÓN ENERGÉTICA

A ++

BOMBILLAS INCLUIDAS

B005/5W

EN

FINISHES

Metal: Matt Black
Brown Leather

Glass Shade (Included):
Opal

MATERIALS

Steel / Blown Glass / Leather

SPECIFICATIONS (UE)

2 x G9 Led - 5W
2700K (Included)
220-240 V, 50/60 Hz
IP20, Class II



ENERGY LABEL

A ++

BULBS INCLUDED

B005/5W

TEC

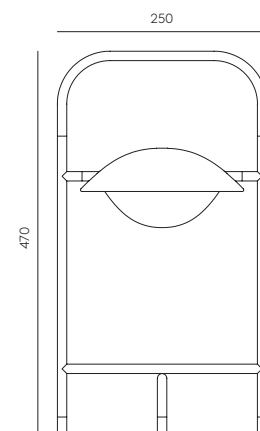

ABBACUS

DESIGNED BY PEPE FORNAS, 2018 · S1258

ES

ACABADOS

Metal: Negro Mate
Oro Mate

Cristal (Incluido):
Opal/Transparente
Opal/Transparente

MATERIALES

Acero / Vidrio Soplado

ESPECIFICACIONES (UE)

Bombilla G9 (Incluida)
5W - 2700K
220-240 V, 50/60 Hz
IP20, Clase II



CLASIFICACIÓN ENERGÉTICA

A ++

BOMBILLA INCLUIDA

B005/5W

EN

FINISHES

Metal: Matt Black
Matt Brass

Glass Shade (Included):
Opal/Clear
Opal/Clear

MATERIALS

Steel / Blown Glass

SPECIFICATIONS (UE)

Bulb G9 (Included)
5W - 2700K
220-240 V, 50/60 Hz
IP20, Class II



ENERGY LABEL

A ++

BULB INCLUDED

B005/5W

TEC

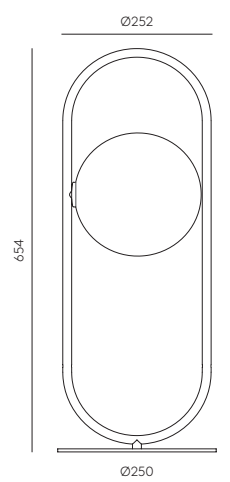

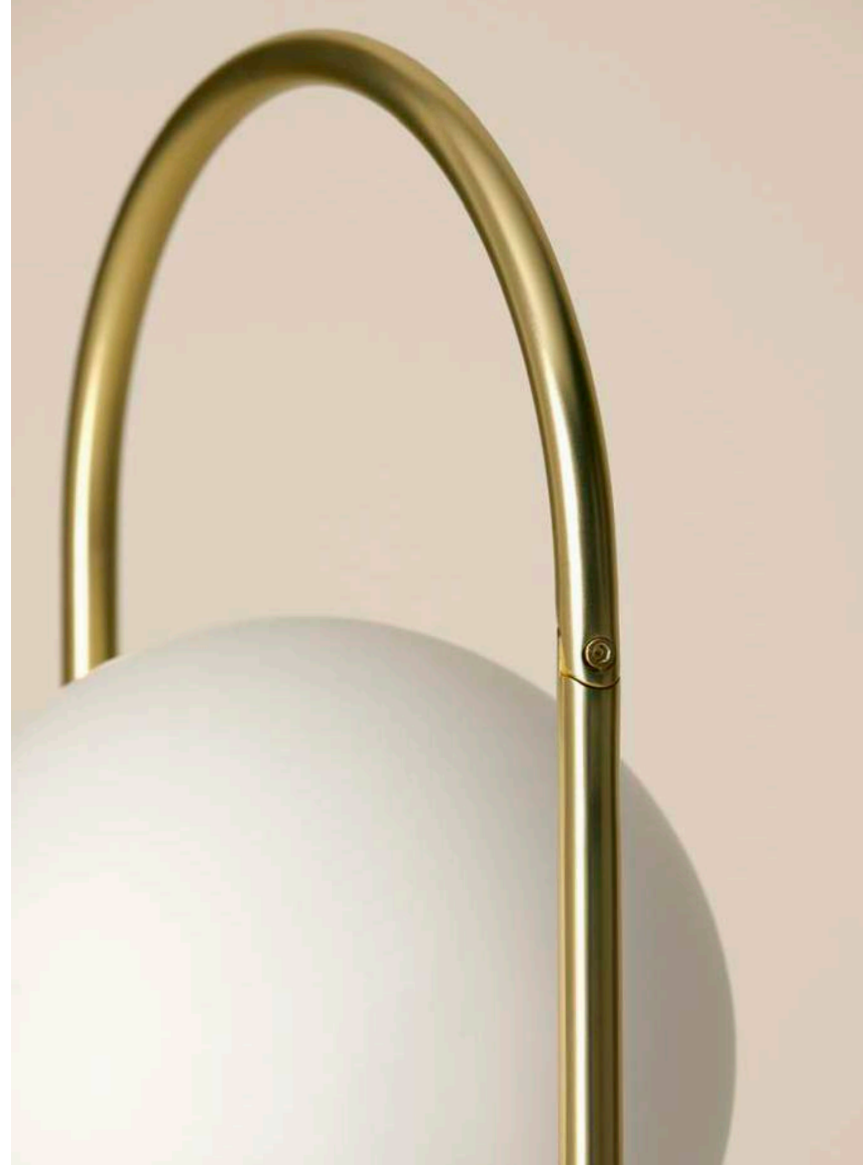



ERTO

DESIGNED BY PEPE FORNAS, 2020 · S1257

ES

ACABADOS

Metal:
Negro Mate
Oro Mate (detalles)

MATERIALES

Acero / Vidrio Soplado

ESPECIFICACIONES (UE)

Bombilla G9 (Incluida)
5W - 2700K
220-240 V, 50/60 Hz
IP20, Clase II



CLASIFICACIÓN ENERGÉTICA

A ++

BOMBILLA INCLUIDA

B005/5W

ACCESORIOS COMPATIBLES (NO INCLUIDO)

Alabastro - 1096/25
Cristal - 1223
Cerámica - 1097/20
Metal - 1038/25
Metal rayado - 1089/25

EN

FINISHES

Metal:
Matt Black
Matt Brass (details)

MATERIALS

Steel / Blown Glass

SPECIFICATIONS (UE)

Bulb G9 (Included)
5W - 2700K
220-240 V, 50/60 Hz
IP20, Class II



ENERGY LABEL

A ++

BULB INCLUDED

B005/5W

COMPATIBLE ACCESSORIES (NOT INCLUDED)

Alabaster - 1096/25
Glass - 1223
Ceramic - 1097/20
Metal - 1038/25
Stripped metal - 1089/25

TEC

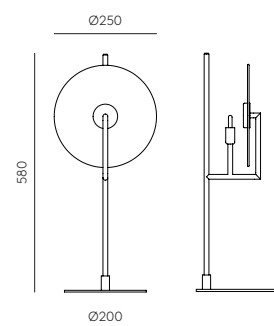

MAHO

DESIGNED BY JF SEVILLA, 2020 · S1254

ES

ACABADOS

Metal:
Todo negro
Negro / Oro Mate (cabeza y detalles)

MATERIALES

Acero

ESPECIFICACIONES (UE)

Chip LED integrado 5W 3000K 24V,
50/60Hz
IP20, Clase II
Touch Me - Regulable en cabeza



CLASIFICACIÓN ENERGÉTICA

A ++

EN

FINISHES

Metal:
All black
Black / Matte Gold (head and details)

MATERIALS

Steel

SPECIFICATIONS (UE)

Integrated LED chip 5W 3000K 24V,
50 / 60Hz
IP20, Class II
Touch Me Dimmer on head



ENERGY LABEL

A ++

TEC

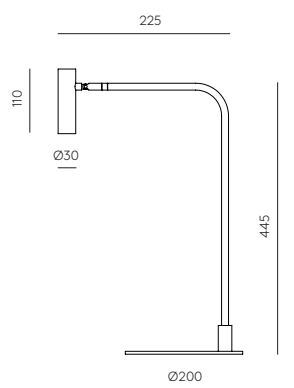

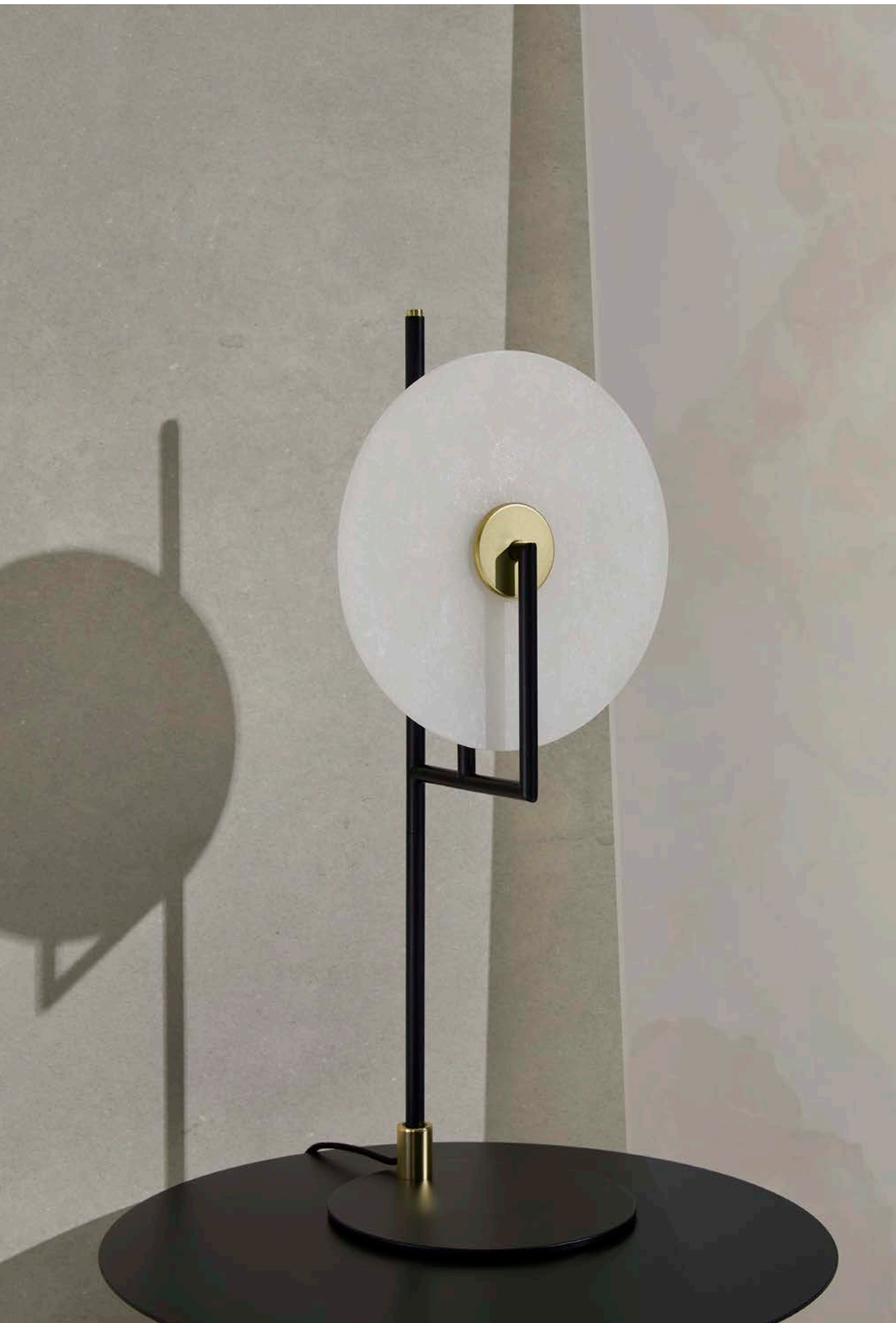



TIVOLI

DESIGNED BY AC STUDIO, 2018 · S1244/S1245

ES

ACABADOS

Metal: Mármol:
Bronze Negro

MATERIALES

Acero / Mármol

ESPECIFICACIONES (UE)

Led integrado
S1244 - 16W - 3000K - 50cm
S1245 - 18W - 3000K - 60cm
12 V, 50/60 Hz, IP20, Clase II



CLASIFICACIÓN ENERGÉTICA
A ++

EN

FINISHES

Metal: Marble:
Bronze Black

MATERIALS

Steel / Marble

SPECIFICATIONS (UE)

Integrated Led strip
S1244 - 16W - 3000K - 50cm
S1245 - 18W - 3000K - 60cm
12 V, 50/60 Hz, IP20, Class II



ENERGY LABEL
A ++

TEC

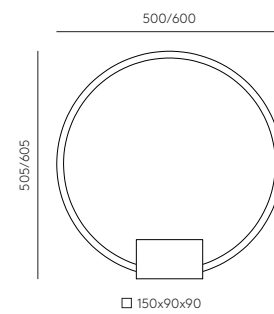

FICUS

DESIGNED BY JF SEVILLA, 2017 · S1243

ES

ACABADOS

Metal: Negro Mate
Oro Mate (Detalles)

Tulipa: Oro Mate

MATERIALES

Acero

ESPECIFICACIONES (UE)

Bombilla G9 (Incluida)
5W - 2700K
220-240 V, 50/60 Hz
IP20, Clase II



CLASIFICACIÓN ENERGÉTICA
A ++

BOMBILLA INCLUIDA
B005/5W

EN

FINISHES

Metal: Matt Black
Matt Gold (Details)

Shade: Matt Brass

MATERIALS

Steel

SPECIFICATIONS (UE)

Bulb G9 (Included)
5W - 2700K
220-240 V, 50/60 Hz
IP20, Class II



ENERGY LABEL
A ++

BULB INCLUDED
B005/5W

TEC

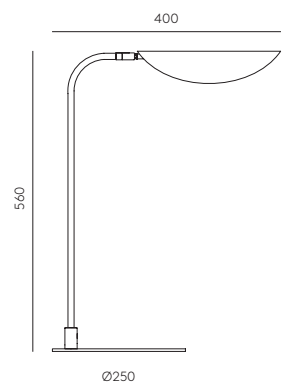





CRANE

DESIGNED BY JF SEVILLA, 2017 · S1241

ES

ACABADOS

Cuerpo: Negro Mate
Tulipa: Cristal Opal
 Oro Mate (detalles)

MATERIALES

Acero / Vidrio Soplado

ESPECIFICACIONES (UE)

Bombilla G9 (Incluida)
 5W - 2700K
 220-240 V, 50/60 Hz
 IP20, Clase II



CLASIFICACIÓN ENERGÉTICA

A ++

EN

FINISHES

Body: Matt Black
Shade: Opal Glass
 Matt Brass (details)

MATERIALS

Steel / Blown Glass

SPECIFICATIONS (UE)

Bulb G9 (Included)
 5W - 2700K
 220-240 V, 50/60 Hz
 IP20, Class II



ENERGY LABEL

A ++

TEC

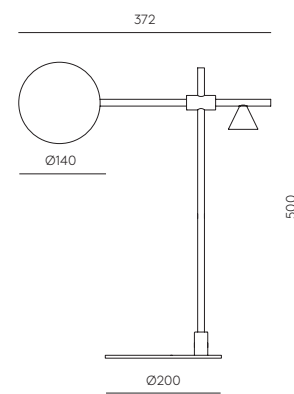

ALOA / ALOA WHITE

DESIGNED BY FORNASEVI, 2017 · S1227 / S1240

ES

ACABADOS

S1227
 Cuerpo: Negro Mate
 Base / Tulipa: Negro Mate

S1240

Cuerpo: Oro Mate
 Base / Tulipa: Blanco Mate

MATERIALES

Acero

ESPECIFICACIONES (UE)

E27 Max. 60W (No incluida)
 220-240 V, 50/60 Hz
 IP20, Clase II



CLASIFICACIÓN ENERGÉTICA

A ++

MODIFICACIONES POSIBLES

Para modificaciones de colores de tulipa y base consultar

BOMBILLA IMAGEN

B038/CROMO

EN

FINISHES

S1227
 Body: Matt Black
 Base / Shade: Matt Black

S1240

Cuerpo: Matt Brass
 Base / Tulipa: Matt White

MATERIALS

Steel

SPECIFICATIONS (UE)

E27 Max. 60W (Not included)
 220-240 V, 50/60 Hz
 IP20, Class II



ENERGY LABEL

A ++

POSSIBLE MODIFICATIONS

See color palette for color modifications (shade & base)

RECOMMENDED BULBS

B038/CHROME

TEC

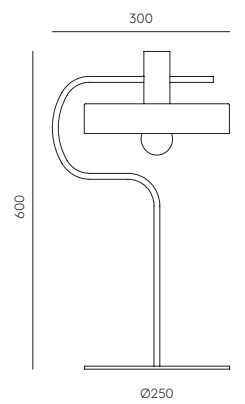





LUCA

DESIGNED BY AC STUDIO, 2017 · S1237

ES

ACABADOS
Metal: Negro Mate Mármol: Blanco

MATERIALES
Acero / Mármol

ESPECIFICACIONES (UE)
E27 Max. 60W (No incluida)
220-240 V, 50/60 Hz
IP20, Clase II



CLASIFICACIÓN ENERGÉTICA
A ++

BOMBILLA RECOMENDADA
B211 (7, 9, 11W)

EN

FINISHES
Metal: Matt Black Marble: White

MATERIALS
Steel / Marble

SPECIFICATIONS (UE)
E27 Max. 60W (Not included)
220-240 V, 50/60 Hz
IP20, Class II



ENERGY LABEL
A ++

RECOMMENDED BULB
B211 (7, 9, 11W)

TEC

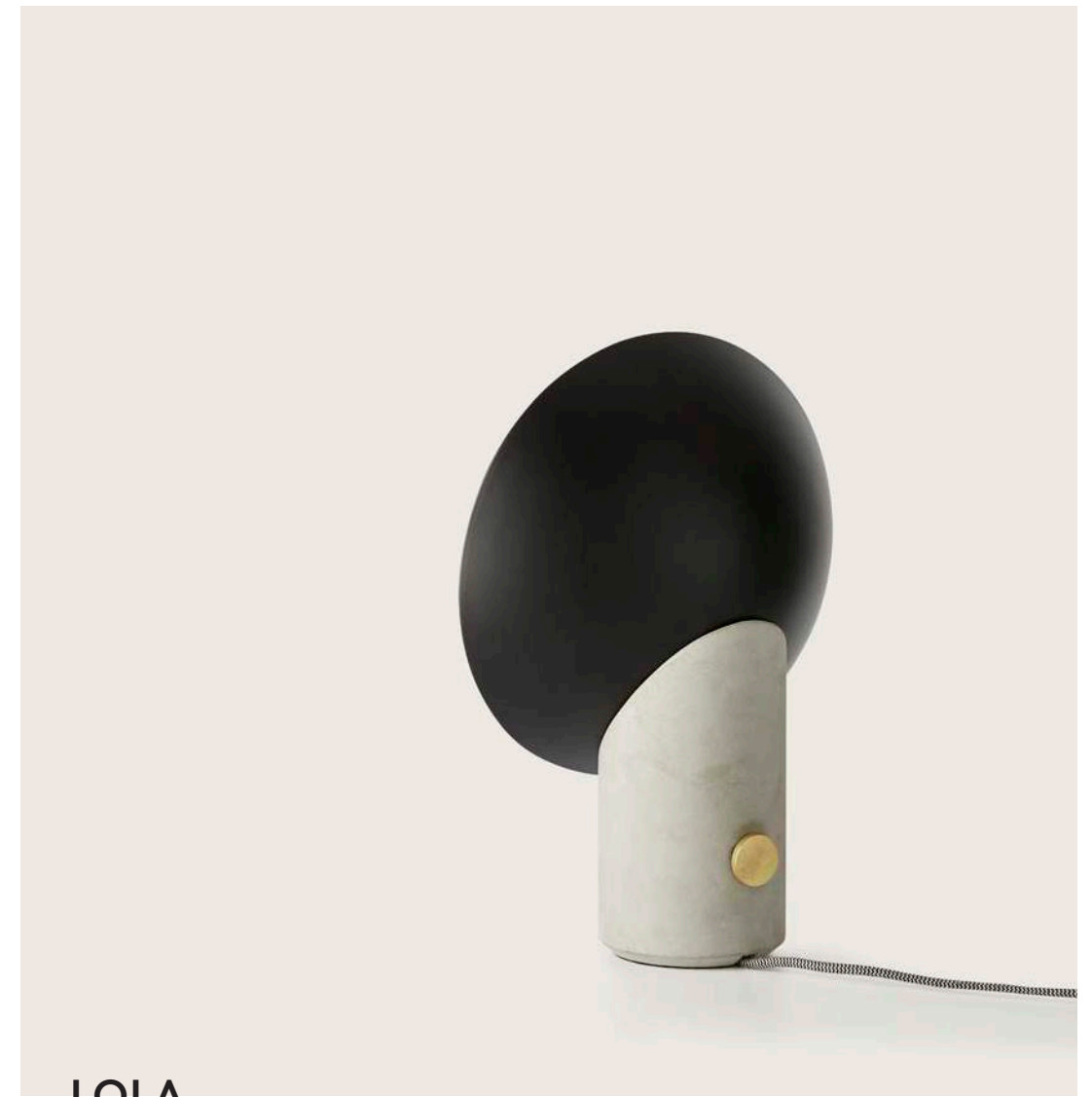
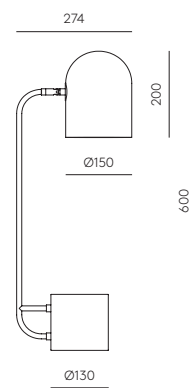

LOLA

DESIGNED BY AC STUDIO, 2017 · S1232

ES

ACABADOS
Metal: Negro Mate Hormigón: Gris

MATERIALES
Acero / Hormigón

ESPECIFICACIONES (UE)
E14 Max. 40W (No incluida)
220-240 V, 50/60 Hz
IP20, Clase II
Regulador en base



CLASIFICACIÓN ENERGÉTICA
A ++

BOMBILLA RECOMENDADA
B116-2/REG

EN

FINISHES
Metal: Matt Black Concrete: Grey

MATERIALS
Steel / Concrete

SPECIFICATIONS (UE)
E14 Max. 40W (Not included)
220-240 V, 50/60 Hz
IP20, Class II
Dimmer on concrete base



ENERGY LABEL
A ++

RECOMMENDED BULB
B116-2/REG

TEC

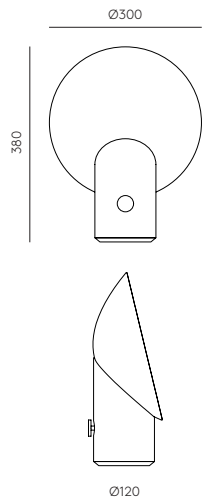



LITA

DESIGNED BY AC STUDIO, 2020 · S1230

ES

ACABADOS

Metal: Negro Mate
Madera: Negro Mate Nogal

MATERIALES

Acero / Madera nogal

ESPECIFICACIONES (UE)

COB LED integrado 3W
3000K (Incluida)
220-240 V, 50/60 Hz

IP20     

CLASIFICACIÓN ENERGÉTICA

A ++

EN

FINISHES

Metal: Matt Black
Wood: Matt Black Walnut

MATERIALS

Steel / Walnut

SPECIFICATIONS (UE)

COB LED integrated 3W
3000K (Included)
220-240 V, 50/60 Hz

IP20     

ENERGY LABEL

A ++

TEC

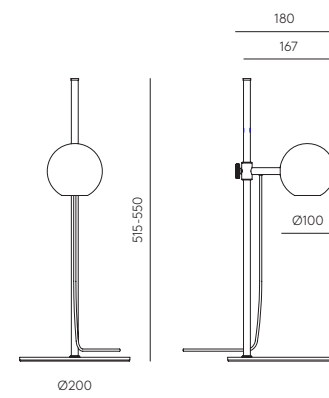

NERA

DESIGNED BY PEPE FORNAS, 2020 · S1229

ES

ACABADOS

Metal: Negro Mate

MATERIALES

Acero / Acrílico

ESPECIFICACIONES (UE)

COB LED integrado 8W 3000K
(Incluida)
12V / 220-240 V, 50/60 Hz
Touch me - Regulable

IP20      

CLASIFICACIÓN ENERGÉTICA

A ++

EN

FINISHES

Metal: Matt black

MATERIALS

Steel / Acrylic

SPECIFICATIONS (UE)

LED COB integrated 8W
3000K (Included)
12V / 220-240 V, 50/60 Hz
Touch me - Dimmable

IP20      

ENERGY LABEL

A ++

TEC

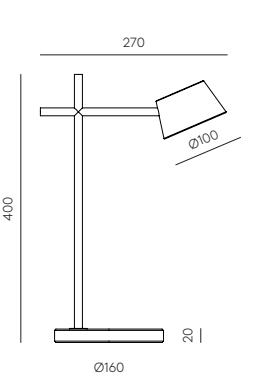



LIND

DESIGNED BY AGUSTÍN GASCÓN, 2020 · S1220

ES

ACABADOS

Metal:
Oro mate (cable y USB)
Negro mate (USB)

Tulipa:
Alabastro

MATERIALES

Acero / Alabastro

CLASIFICACIÓN ENERGÉTICA

A ++

MODEL. CABLE

ESPECIFICACIONES (UE)

Bombilla G9 Led (Incluida)
5W - 3000K
220-240 V, 50/60 Hz
IP20, Clase II

MODEL. PORTABLE

ESPECIFICACIONES (UE)

COB LED integrado 3W 3000K (Incluida)
4.2 V, 1A, 50/60 Hz
Touch me - Regulable
Portátil y recargable
Cargador USB incluido

EN

FINISHES

Metal:
Matt Brass (cable & USB)
Matt Black (USB)

Shade:
Alabaster

MATERIALS

Steel / Alabaster

ENERGY LABEL

A ++

CABLE MODEL

SPECIFICATIONS (UE)

Bulb G9 Led (Included)
5W - 3000K
220-240 V, 50/60 Hz
IP20, Class II

PORTABLE MODEL

SPECIFICATIONS (UE)

LED COB integrated 3W 3000K (Included)
4.2 V, 1A, 50/60 Hz
Touch me - Dimmable
Portable and rechargeable
USB charger included

TEC

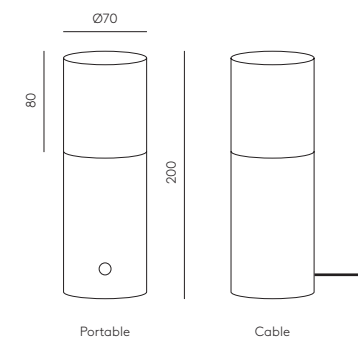

IP20 CE RoHS A++





ATOM

DESIGNED BY AC STUDIO, 2017 · S1214

ES

ACABADOS
Metal: Negro Mate / Oro Mate
Cristal (Incluido): Opal/Transparente / Opal/Transparente

MATERIALES
 Acero / Vidrio Soplado

ESPECIFICACIONES (UE)
 Bombilla G9 (Incluida)
 5W - 2700K
 220-240 V, 50/60 Hz
 IP20, Clase II



CLASIFICACIÓN ENERGÉTICA
 A ++

BOMBILLA INCLUIDA
 B005/5W

EN

FINISHES
Metal: Matt Black / Matt Brass
Glass Shade (Included): Opal/Clear / Opal/Clear

MATERIALS
 Steel / Blown Glass

SPECIFICATIONS (UE)
 Bulb G9 (Included)
 5W - 2700K
 220-240 V, 50/60 Hz
 IP20, Class II



ENERGY LABEL
 A ++

BULB INCLUDED
 B005/5W

TEC

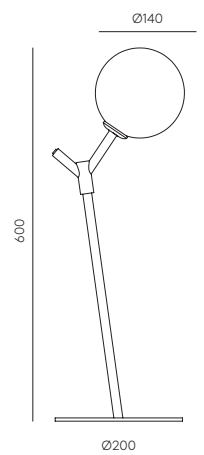



SUN LIGHT

DESIGNED BY FORNASEVI, 2015 · S1208

ES

ACABADOS

Metal: Mármol:
Negro Mate Negro
Oro Brillo Blanco

MATERIALES

Acero / Mármol

ESPECIFICACIONES (UE)

E27 Max. 60W (No incluida)
220-240 V, 50/60 Hz
IP20, Clase II



CLASIFICACIÓN ENERGÉTICA

A ++

MODIFICACIONES POSIBLES

Accesorios disponibles en pág. 362
Accesorio / Bombilla foto:
1038/25/ORO
(Accesorio no incluido)
B038/ORO

EN

FINISHES

Metal: Marble:
Matt Black Black
Shinny Gold White

MATERIALS

Steel / Marble

SPECIFICATIONS (UE)

E27 Max. 60W (Not included)
220-240 V, 50/60 Hz
IP20, Class II



ENERGY LABEL

A ++

POSSIBLE MODIFICATIONS

Accessories available are on page 362
Accessory / Bulb image:
1038/25/ORO
(Accessory not included)
B038/GOLD

TEC

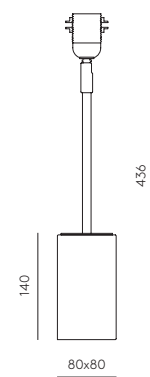

DOBI

DESIGNED BY AC STUDIO, 2015 · S1207

ES

ACABADOS

Metal:
Negro Mate Negro
Blanco Mate Blanco

MATERIALES

Acero

ESPECIFICACIONES (UE)

E14 Max. 33W (No incluida)
220-240 V, 50/60 Hz
IP20, Clase II



CLASIFICACIÓN ENERGÉTICA

A ++

BOMBILLA RECOMENDADA

B116-2 (5W)

EN

FINISHES

Metal:
Matt Black Black
Matt White White

MATERIALS

Steel

SPECIFICATIONS (UE)

E14 Max. 33W (Not included)
220-240 V, 50/60 Hz
IP20, Class II



ENERGY LABEL

A ++

RECOMMENDED BULB

B116-2 (5W)

TEC

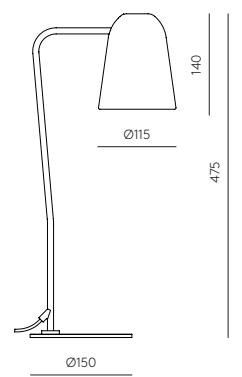





CHATEAU

DESIGNED BY JF SEVILLA, 2015 · S1205

ES

ACABADOS
Metal:
Negro Mate

MATERIALES
Acero

ESPECIFICACIONES (UE)
E27 Max. 60W (No incluida)
230 V, 50/60 Hz
IP20, Clase II



CLASIFICACIÓN ENERGÉTICA
A ++

MODIFICACIONES POSIBLES
Pantalla imagen 1143
Pantalla no incluida

BOMBILLA RECOMENDADA
B211 (7, 9, 11W)

EN

FINISHES
Metal:
Matt Black

MATERIALS
Steel

SPECIFICATIONS (UE)
E27 Max. 60W (Not included)
230 V, 50/60 Hz
IP20, Class II



ENERGY LABEL
A ++

POSSIBLE MODIFICATIONS
Image reference shade 1143
Shade not included

RECOMMENDED BULB
B211 (7, 9, 11W)

TEC

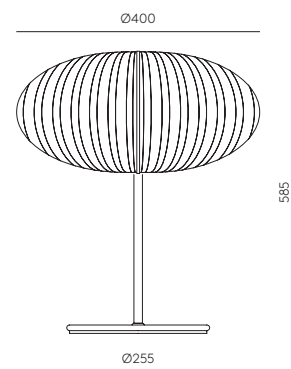

MARU

DESIGNED BY JF SEVILLA, 2015 · S1194

ES

ACABADOS
Metal:
Negro Mate - Oro Mate
Negro Mate - Negro Mate

MATERIALES
Acero

ESPECIFICACIONES (UE)
Led COB integrado
3W - 3150K
12 V, 50/60 Hz
IP20, Clase II



CLASIFICACIÓN ENERGÉTICA
A ++

EN

FINISHES
Metal:
Matt Black - Matt Brass
Matt Black - Matt Black

MATERIALS
Steel

SPECIFICATIONS (UE)
Integrated Led COB
3W - 3150K
12 V, 50/60 Hz
IP20, Class II



ENERGY LABEL
A ++

TEC

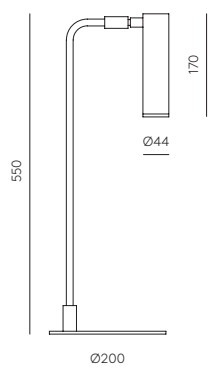



LUA/BOA

DESIGNED BY FORNASEVI, 2015 · S1147/S1193

ES

ACABADOS

LUA - S1147
Metal: Cromo
Tulipa: Rojo, Negro, Blanco Brillo

BOA - S1193

Metal: Negro Mate
Tulipa: Negro, Oro Mate

MATERIALES

Acero

ESPECIFICACIONES (UE)

E27 Max. 60W (No incluida)
220-240 V, 50/60 Hz
IP20, Clase II



CLASIFICACIÓN ENERGÉTICA
A ++

BOMBILLA RECOMENDADA
B211 (7, 9, 11W)

EN

FINISHES

LUA - S1147
Metal: Chrome
Shade: Red, Black, Shiny White

BOA - S1193

Metal: Matt Black
Shade: Black, Matt Brass

MATERIALS

Steel

SPECIFICATIONS (UE)

E27 Max. 60W (Not included)
220-240 V, 50/60 Hz
IP20, Class II



ENERGY LABEL
A ++

RECOMMENDED BULB
B211 (7, 9, 11W)

TEC

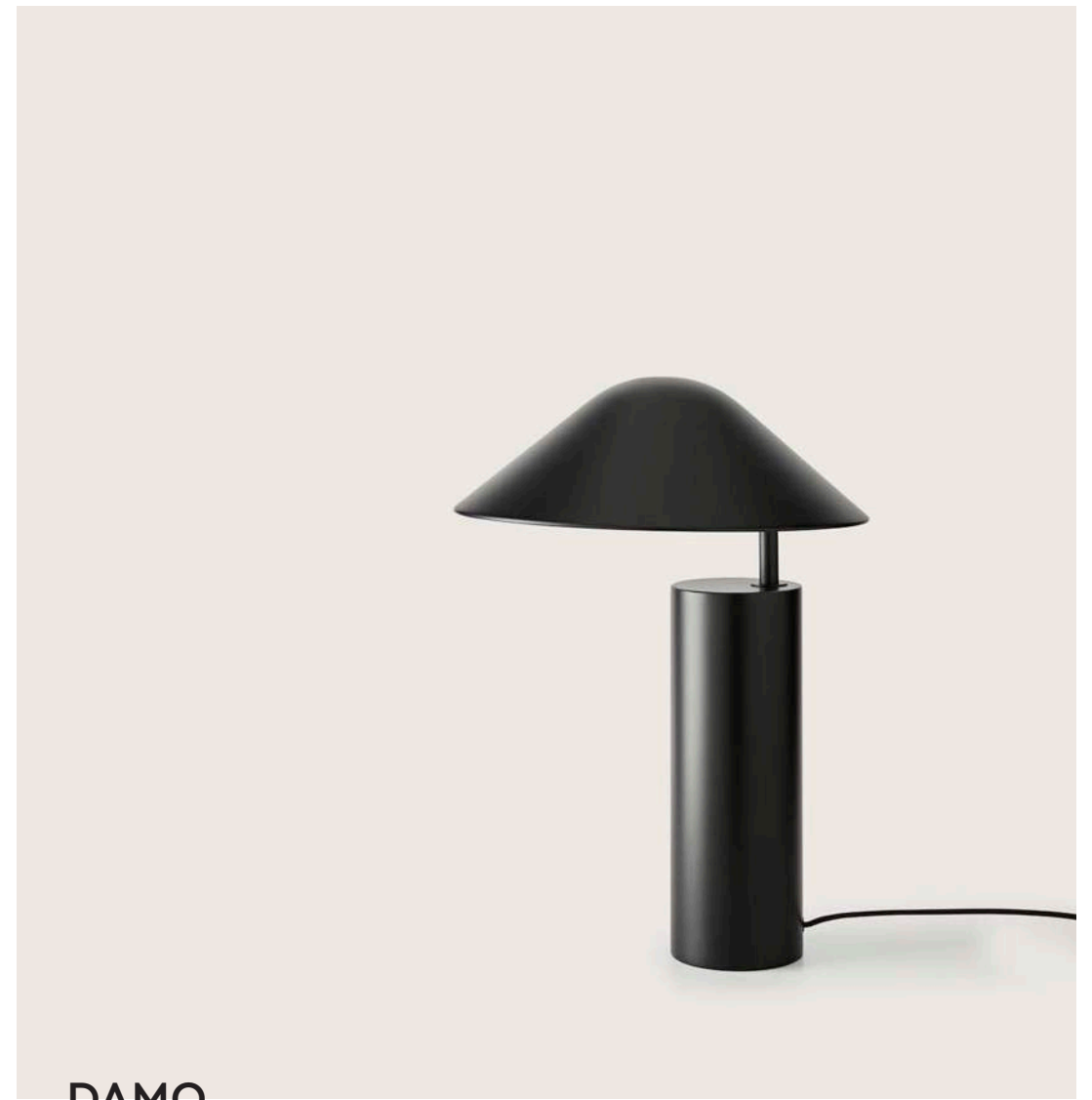
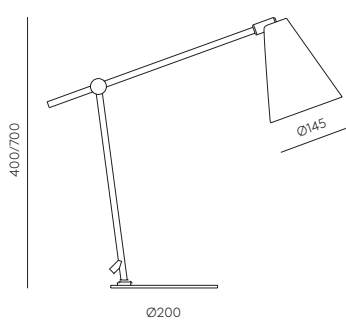

DAMO

DESIGNED BY AC STUDIO, 2015 · S1191

ES

ACABADOS

Metal:
Negro Mate

MATERIALES

Acero

ESPECIFICACIONES (UE)

E27 Max. 60W (No incluida)
230 V, 50/60 Hz
IP20, Clase II



CLASIFICACIÓN ENERGÉTICA
A ++

BOMBILLA RECOMENDADA
B211 (7, 9, 11W)

EN

FINISHES

Metal:
Matt Black

MATERIALS

Steel

SPECIFICATIONS (UE)

E27 Max. 60W (Not included)
230 V, 50/60 Hz
IP20, Class II



ENERGY LABEL
A ++

RECOMMENDED BULB
B211 (7, 9, 11W)

TEC

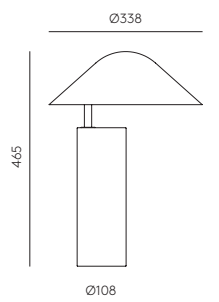





LALU

DESIGNED BY JANA CHANG, 2013 · S1189

ES

ACABADOS

Metal: Tulipa:
Cromo Blanco
Oro Brillo Blanco

MATERIALES

Acero

ESPECIFICACIONES (UE)

E27 Max. 60W (No incluida)
230 V, 50/60 Hz
IP20, Clase II



CLASIFICACIÓN ENERGÉTICA

A ++

MODIFICACIONES POSIBLES

Para modificaciones en color de pantalla consultar sobrecoste. Paleta de colores en pág. 372

COLOR TULIPA AMBIENTE

NCS S2005G70Y

BOMBILLAS RECOMENDADAS

B211 (7,9,11W)

EN

FINISHES

Metal: Shade:
Chrome White
Shiny brass White

MATERIALS

Steel

SPECIFICATIONS (UE)

E27 Max. 60W (Not included)
230 V, 50/60 Hz
IP20, Class II



ENERGY LABEL

A ++

POSSIBLE MODIFICATIONS

Color shade can be changed, ask us about extracost. Color palette on page 107

SHADE COLOR AMBIENT

NCS S2005G70Y

RECOMMENDED BULB

B211 (7,9,11W)

TEC

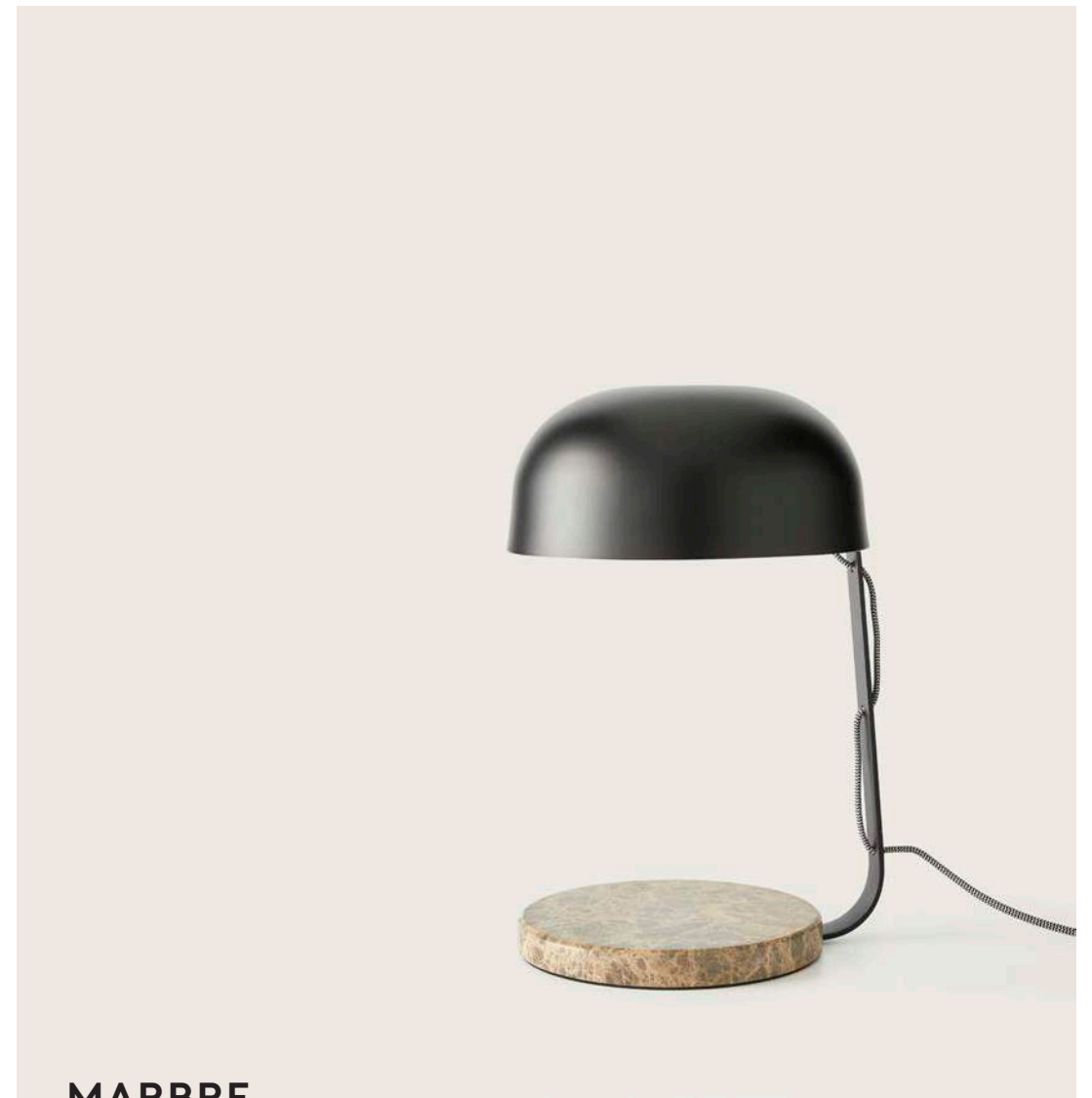
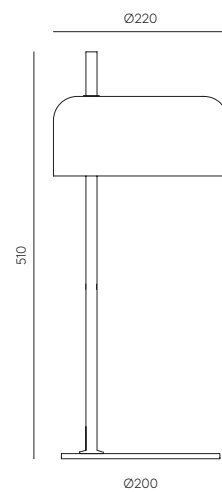

MARBRE

DESIGNED BY ESTUDIO COSÍ, 2014 · S1188

ES

ACABADOS

Metal: Mármol:
Negro Mate Marrón

MATERIALES

Acero / Mármol

ESPECIFICACIONES (UE)

E27 Max. 60W (No incluida)
230 V, 50/60 Hz
IP20, Clase II



CLASIFICACIÓN ENERGÉTICA

A ++

EN

FINISHES

Metal: Marble:
Matt Black Brown

MATERIALS

Steel / Marble

SPECIFICATIONS (UE)

E27 Max. 60W (Not included)
230 V, 50/60 Hz
IP20, Class II



ENERGY LABEL

A ++

TEC

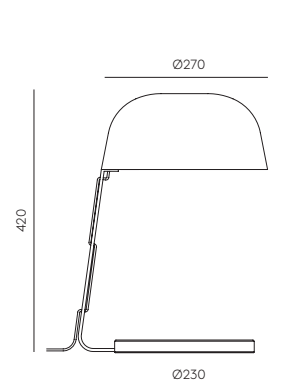

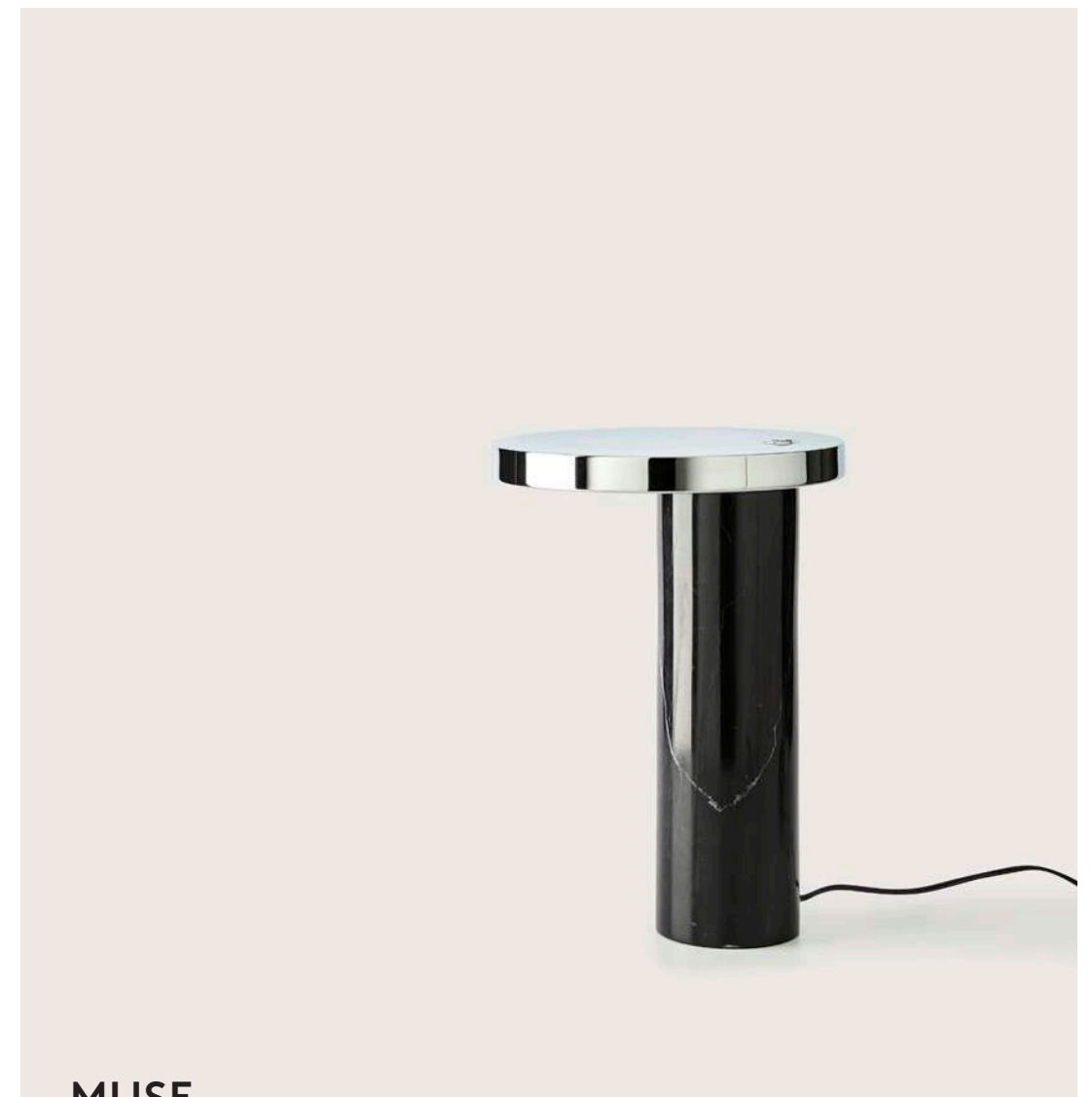

MUSE

DESIGNED BY ESTUDIO COSÍ, 2014 · S1187

ES

ACABADOS
Cuerpo: Mármol Negro **Tulipa:** Cromo

MATERIALES
 Acero / Mármol

ESPECIFICACIONES (UE)
 Chip Led regulable integrado 5W,
 3000K - 450 lm
 12 V, 50/60 Hz
 IP20, Clase II



CLASIFICACIÓN ENERGÉTICA
 A ++

INTERRUPTOR TOUCH ME REGULABLE

EN

FINISHES
Body: Black Marble **Shade:** Chrome

MATERIALS
 Steel / Marble

SPECIFICATIONS (UE)
 Chip Led dimmable integrated
 5W, 3000K - 450 lm
 12 V, 50/60 Hz
 IP20, Class II



ENERGY LABEL
 A ++

SWITCH TOUCH ME DIMMABLE

TEC

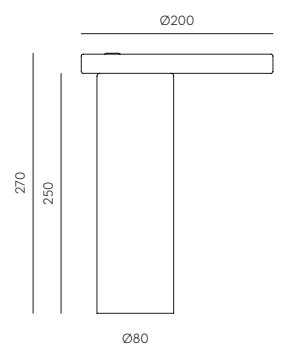

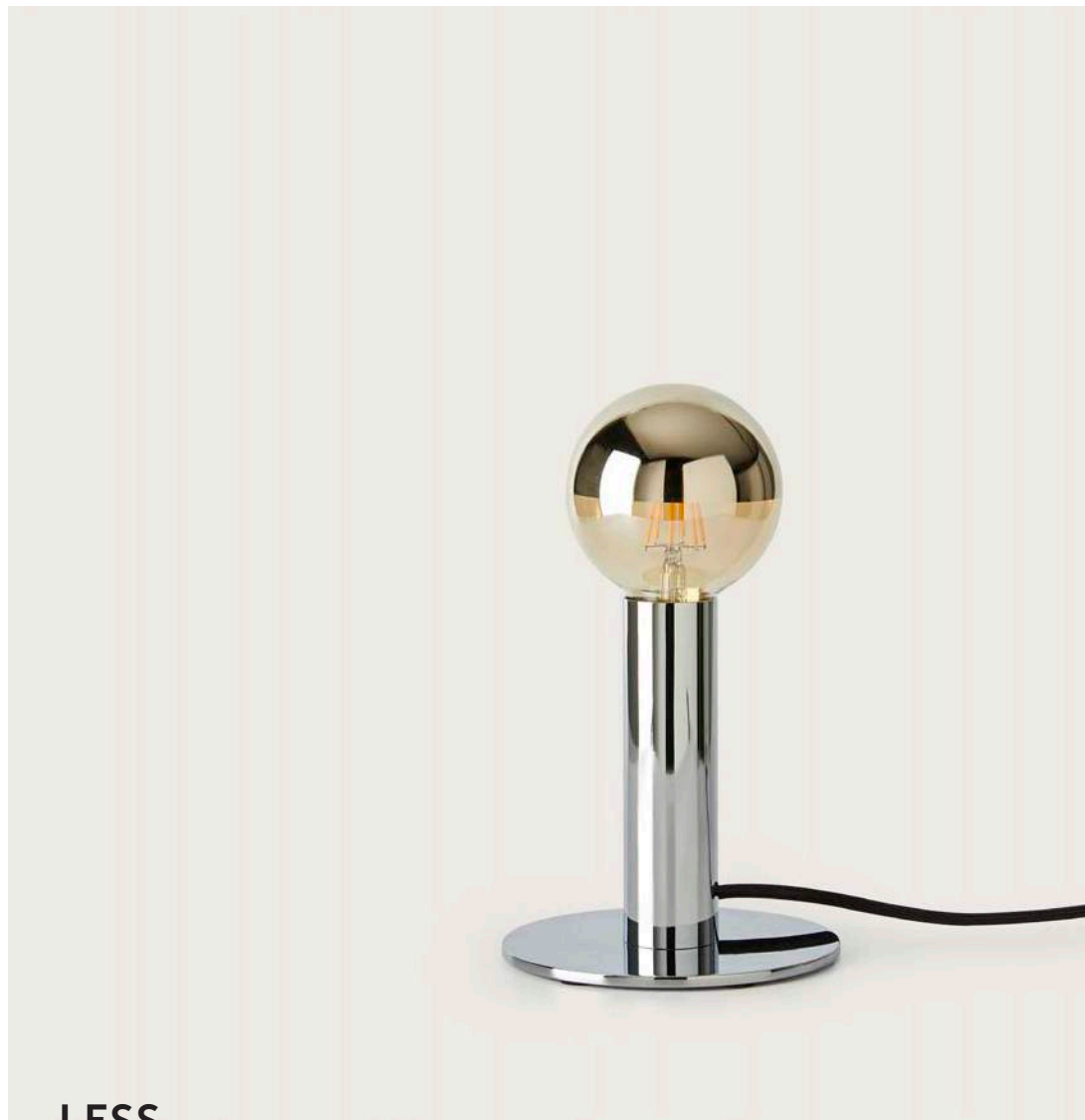

LESS

DESIGNED BY JF SEVILLA, 2014 · S1171

ES

ACABADOS

Metal:
Oro Mate
Cromo
Cobre

MATERIALES

Acero

ESPECIFICACIONES (UE)

E27 Max. 60W (No incluida)
220-240 V, 50/60 Hz
IP20, Clase II



CLASIFICACIÓN ENERGÉTICA

A ++

BOMBILLA RECOMENDADA

B035 ó B053

EN

FINISHES

Metal:
Matt Brass
Chrome
Copper

MATERIALS

Steel

SPECIFICATIONS (UE)

E27 Max. 60W (Not included)
220-240 V, 50/60 Hz
IP20, Class II



ENERGY LABEL

A ++

RECOMMENDED BULB

B035 or B053

TEC

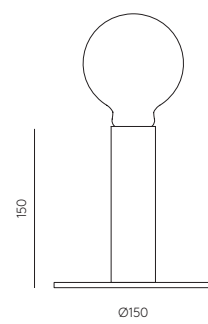



MILA

DESIGNED BY AC STUDIO, 2014 · S1183

ES

ACABADOS

Metal:
Cromo
Oro Mate

Pantalla:
Blanco
Negro

MATERIALES

Acero / Pantalla Textil / Acrílico

ESPECIFICACIONES (UE)

E14 - 2 x Max. 40W
(No incluida)
220-240 V, 50/60 Hz
IP20, Clase II



CLASIFICACIÓN ENERGÉTICA

A ++

PANTALLA INCLUIDA

BOMBILLAS RECOMENDADAS
B116-2 (5W)

EN

FINISHES

Metal:
Chrome
Matt Brass

Shade:
White
Black

MATERIALS

Steel / Fabric / Acrylic

SPECIFICATIONS (UE)

E14 - 2 x Max. 40W
(Not included)
220-240 V, 50/60 Hz
IP20, Class II



ENERGY LABEL

A ++

SHADE INCLUDED

RECOMMENDED BULBS
B116-2 (5W)

TEC

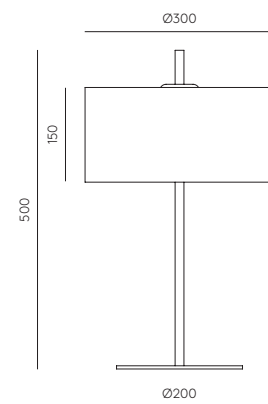

ENDO

DESIGNED BY PEPE FORNAS, 2013 · S1156

ES

ACABADOS

Metal:
Oro Mate
Cromo

Cristal (Incluido)
Opal
Opal

MATERIALES

Acero / Vidrio Soplado

ESPECIFICACIONES (UE)

Bombilla G9 Led - 5W (Incluida)
2700K
220-240 V, 50/60 Hz
IP20, Clase II



CLASIFICACIÓN ENERGÉTICA

A ++

BOMBILLA INCLUIDA

B005/5W

EN

FINISHES

Metal:
Matt Brass
Chrome

Shade (Included)
Opal
Opal

MATERIALS

Steel / Blown Glass

SPECIFICATIONS (UE)

Bulb G9 Led - 5W (Included)
2700K
220-240 V, 50/60 Hz
IP20, Class II



ENERGY LABEL

A ++

BULB INCLUDED

B005/5W

TEC

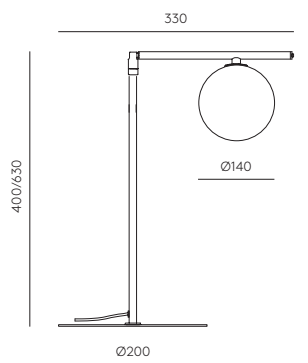





STAN

DESIGNED BY FORNASEVI, 2018 · S1154

ES

ACABADOS

Metal: Oro Mate
Negro Mate

Ratán: Natural/Negro
Natural/Negro

MATERIALES

Acero / Ratán

ESPECIFICACIONES (UE)

E27 Max. 60W (No incluida)
220-240 V, 50/60 Hz
IP20, Clase II



CLASIFICACIÓN ENERGÉTICA
A ++

BOMBILLA RECOMENDADA
B033/COB

EN

FINISHES

Metal: Matt Brass
Matt Black

Rattan: Natural/Black
Natural/Black

MATERIALS

Steel / Rattan

SPECIFICATIONS (UE)

E27 Max. 60W (Not included)
220-240 V, 50/60 Hz
IP20, Class II



ENERGY LABEL
A ++

RECOMMENDED BULB
B033/COB

TEC

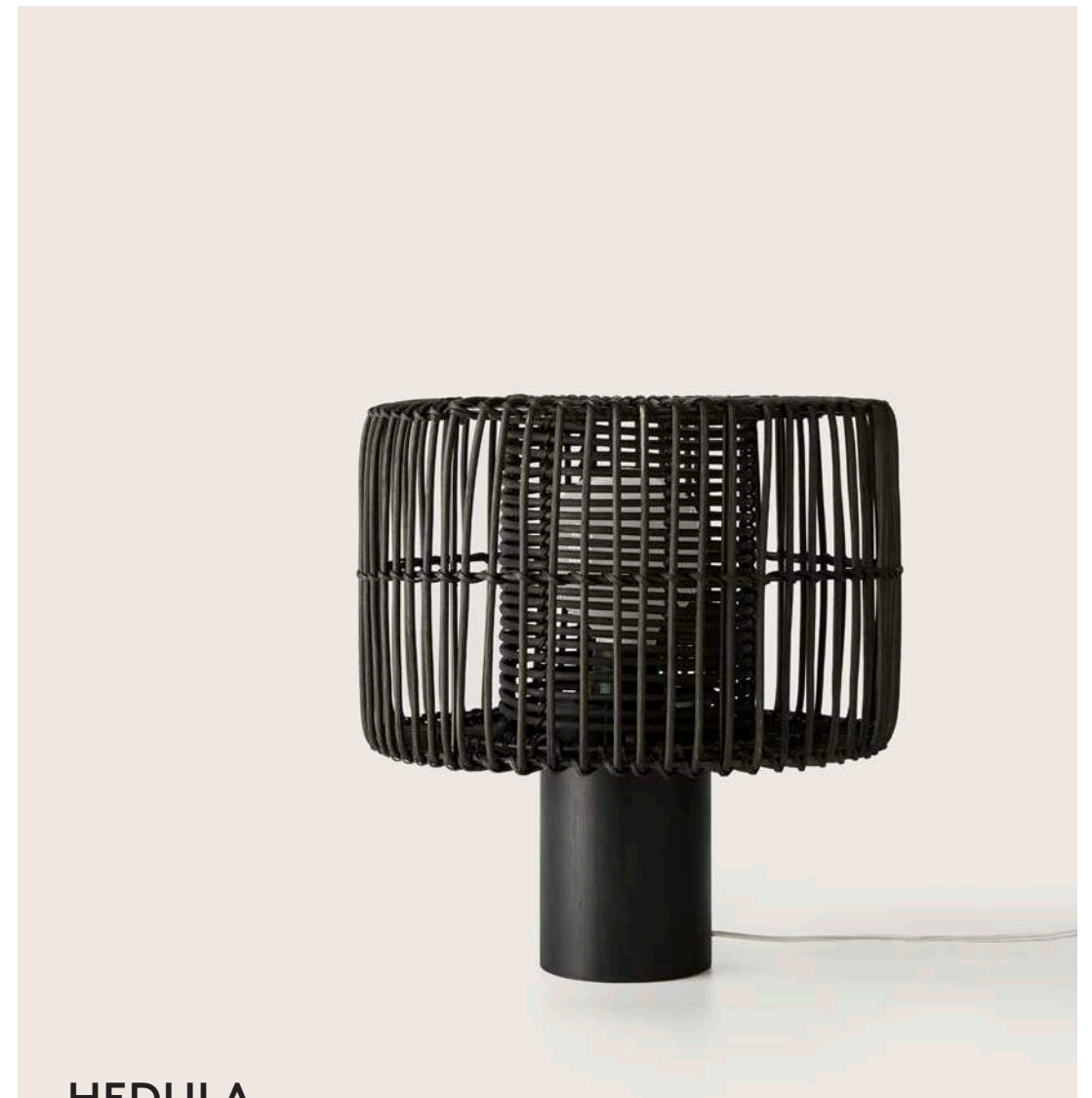
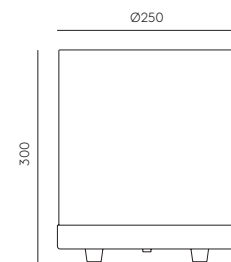

HEDULA

DESIGNED BY AC STUDIO, 2020 · S1150 + 1160/30

ES

ACABADOS

Madera: Negro
Natural
Color

Médula: Negro

MATERIALES

Madera / Médula

ESPECIFICACIONES (UE)

E27 max. 60W (No incluida)
220-240 V, 50/60 Hz



CLASIFICACIÓN ENERGÉTICA
A ++

BASE Y PANTALLA - SE VENDE POR SEPARADO

EN

FINISHES

Metal: Black
Natural
Colour

Fiber: Black

MATERIALS

Wood / Natural Fiber

SPECIFICATIONS (UE)

E27 max. 60W (Not included)
220-240 V, 50/60 Hz



ENERGY LABEL
A ++

BASE AND SHADE - SOLD INDIVIDUALLY

TEC

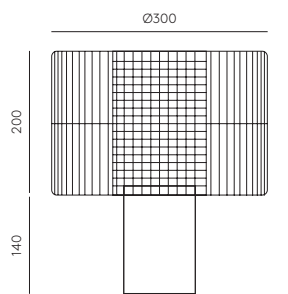





RIU

DESIGNED BY JF SEVILLA, 2012 · S1140

ES

ACABADOS

Metal:	Pantalla:	Madera:
Negro Mate	Negro	Haya
Blanco Mate	Blanco	Haya

MATERIALES

Acero / Madera / Textil / Acrílico

ESPECIFICACIONES (UE)

E27 Max. 60W (No incluida)
220-240 V, 50/60 Hz
IP20, Clase II



CLASIFICACIÓN ENERGÉTICA

A ++

BOMBILLA RECOMENDADA

B211 (7, 9, 11W)

EN

ACABADOS

Metal:	Shade:	Wood:
Matt Black	Black	Beech
Matt White	White	Beech

MATERIALS

Steel / Wood / Fabric / Acrylic

SPECIFICATIONS (UE)

E27 Max. 60W (Not included)
220-240 V, 50/60 Hz
IP20, Class II



ENERGY LABEL

A ++

RECOMMENDED BULB

B211 (7, 9, 11W)

TEC

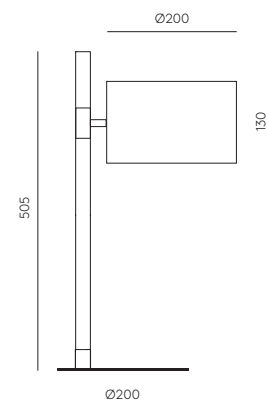

PAGO

DESIGNED BY PEPE FORNAS, 2010 · S1126

ES

ACABADOS

Metal:
Blanco Brillo - Cromo
Negro Brillo - Oro Brillo
Negro Brillo - Cromo

MATERIALES

Acero

ESPECIFICACIONES (UE)

GU10 Max. 50W (No incluida)
220-240 V, 50/60 Hz
IP20, Clase II



CLASIFICACIÓN ENERGÉTICA

A ++

BOMBILLA RECOMENDADA

B161 (5W)

EN

ACABADOS

Metal:
Shinny White - Chrome
Shinny Black - Shinny Gold
Shinny Black - Chrome

MATERIALS

Steel

SPECIFICATIONS (UE)

GU10 Max. 50W (Not included)
220-240 V, 50/60 Hz
IP20, Class II



ENERGY LABEL

A ++

RECOMMENDED BULB

B161 (5W)

TEC

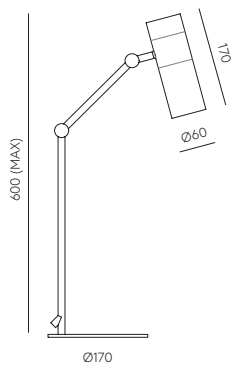



COHEN / COHEN GOLD

DESIGNED BY JANA CHANG, 2012 · S1122 / S1196

ES

ACABADOS
COHEN - S1122
 Metal: Cromo
 Tulipa: Negro, Blanco Brillo

COHEN GOLD - S1196
 Metal: Oro Mate
 Tulipa: Negro, Blanco Brillo

MATERIALES
 Acero

ESPECIFICACIONES (UE)
 E27 Max. 60W (No incluida)
 220-240 V, 50/60 Hz
 IP20, Clase II



CLASIFICACIÓN ENERGÉTICA
 A ++

BOMBILLA RECOMENDADA
 B211 (7, 9, 11W)

EN

FINISHES
COHEN - S1122
 Metal: Chrome
 Shade: Black, Shiny White

COHEN GOLD - S1196
 Metal: Matt Brass
 Shade: Black, Shiny White

MATERIALS
 Steel

SPECIFICATIONS (UE)
 E27 Max. 60W (Not included)
 220-240 V, 50/60 Hz
 IP20, Class II



ENERGY LABEL
 A ++

RECOMMENDED BULB
 B211 (7, 9, 11W)

TEC

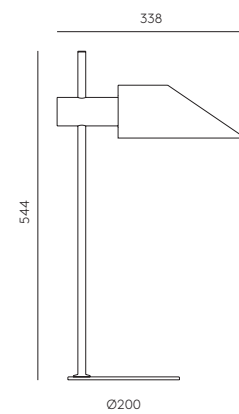

SAND

DESIGNED BY AC STUDIO, 2019 · S1109

ES

ACABADOS
Terrazzo:
 Gris

MATERIALES
 Terrazzo

ESPECIFICACIONES (UE)
 E27 Max. 40W (No incluida)
 220-240 V, 50/60 Hz
 IP20, Clase II



DIMERABLE

CLASIFICACIÓN ENERGÉTICA
 A ++

PANTALLA INCLUIDA

BOMBILLA RECOMENDADA
 B211/9W - Regulable

EN

FINISHES
Terrazzo:
 Grey

MATERIALS
 Terrazzo

SPECIFICATIONS (UE)
 E27 Max. 40W (Not included)
 220-240 V, 50/60 Hz
 IP20, Class II



DIMMABLE

ENERGY LABEL
 A ++

SHADE INCLUDED

RECOMMENDED BULB
 B211/9W - Dimmable

TEC

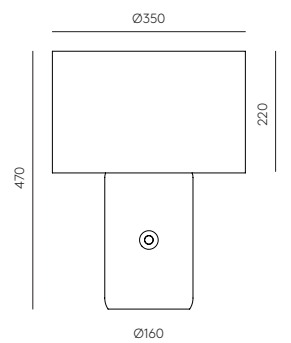



CAND

DESIGNED BY AC STUDIO, 2018 · S1107

ES

ACABADOS

Metal: Oro Envejecido
Níquel

Mármol: Negro
Verde
Marrón

MATERIALES

Acero / Mármol

ESPECIFICACIONES (UE)

E27 Max. 60W (No incluida)
220-240 V, 50/60 Hz, IP20,
Clase II



CLASIFICACIÓN ENERGÉTICA
A ++

MODIFICACIONES POSIBLES
Pantalla imagen 801021/35
Pantalla no incluida

BOMBILLA RECOMENDADA
B211 (7, 9, 11W)

EN

FINISHES

Metal: Aged Gold
Nickel

Marble: Black
Green
Brown

MATERIALS

Steel / Marble

SPECIFICATIONS (UE)

E27 Max. 60W (Not included)
220-240 V, 50/60 Hz, IP20, Class II



ENERGY LABEL
A ++

POSSIBLE MODIFICATIONS
Image reference shade 801021/35
Shade not included

RECOMMENDED BULB
B211 (7, 9, 11W)

TEC

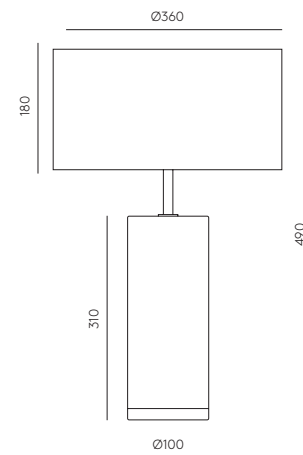

ALDA

DESIGNED BY AC STUDIO, 2020 · S1108

ES

ACABADOS

Metal: Negro Mate
Blanco Mate
Oro Mate
Oro Brillo
Cromo

Madera: Negro
Natural
Color

Mármol: Negro
Blanco
Verde
Marrón

MATERIALES

Acero / Madera / Mármol

ESPECIFICACIONES (UE)

E27 max. 60W (No incluida)
220-240 V, 50/60 Hz



PANTALLA 04501 NO INCLUIDA

CLASIFICACIÓN ENERGÉTICA
A ++

**CONSULTAR POSIBILIDADES DE
CUSTOMIZACIÓN**

EN

FINISHES

Metal: Matt black
Matt white
Matt brass
Shiny gold
Chrome

Wood: Black
Natural
Colour

Marble: Black
White
Green
Brown

MATERIALS

Steel / Wood / Marble

SPECIFICATIONS (UE)

E27 max. 60W (Not included)
220-240 V, 50/60 Hz



SHADE 04501 NOT INCLUDED

ENERGY LABEL
A ++

ASK FOR CUSTOMIZED POSSIBILITIES

TEC

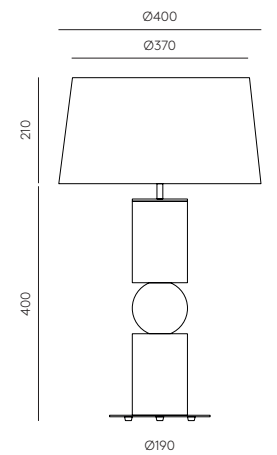





FUNN

DESIGNED BY AC STUDIO, 2018 · S1104

ES

ACABADOS

Metal:	Mármol:	Pantalla:
Negro Mate	Blanco	Opal
Bronce	Marrón	Opal
Oro Envejecido	Verde	Opal

MATERIALES

Acero / Mármol / Vidrio Soplado

ESPECIFICACIONES (UE)

Bombilla G9 Led (Incluida)
5W - 3000K
220-240 V, 50/60 Hz
IP20, Clase II



CLASIFICACIÓN ENERGÉTICA

A ++

BOMBILLA INCLUIDA

B005/5W

EN

FINISHES

Metal:	Marble:	Glass:
Matt Black	White	Opal
Bronze	Brown	Opal
Aged Gold	Green	Opal

MATERIALS

Steel / Marble / Blown Glass

SPECIFICATIONS (UE)

Bulb G9 Led (Included)
5W - 3000K
220-240 V, 50/60 Hz
IP20, Class II



ENERGY LABEL

A ++

BULB INCLUDED

B005/5W

TEC

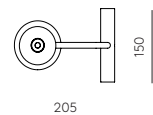
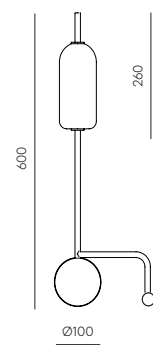

ECLETIC

DESIGNED BY AC STUDIO, 2010 · S1042

ES

ACABADOS

Metal:
Cromo
Oro Brillo
Negro
Blanco

MATERIALES

Acero

ESPECIFICACIONES (UE)

E27 Max. 60W (No incluida)
220-240 V, 50/60 Hz, IP20, Clase II



CLASIFICACIÓN ENERGÉTICA

A ++

MODIFICACIONES POSIBLES

Pantalla imagen 801021/30
Pantalla no incluida

BOMBILLA RECOMENDADA

B211 (7, 9, 11W)

EN

FINISHES

Metal:
Chrome
Shinny Gold
Black
White

MATERIALS

Steel

SPECIFICATIONS (UE)

E27 Max. 60W (Not included)
220-240 V, 50/60 Hz, IP20, Class II



ENERGY LABEL

A ++

POSSIBLE MODIFICATIONS

Image reference shade 801021/30
Shade not included

RECOMMENDED BULB

B211 (7, 9, 11W)

TEC

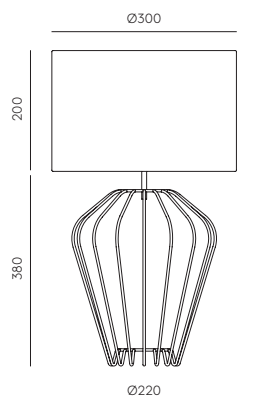



ONA

DESIGNED BY AC STUDIO, 2008 · S1029

ES

ACABADOS

Metal: Pantalla lisa:
 Níquel Blanco
 Negro

MATERIALES

Acero / Pantalla Textil / Acrílico

ESPECIFICACIONES (UE)

E14 - 2 x Max. 40W
 (No incluida)
 220-240 V, 50/60 Hz
 IP20, Clase II



CLASIFICACIÓN ENERGÉTICA
 A ++

PANTALLA INCLUIDA

BOMBILLAS RECOMENDADAS
 B116-2 (5W)

EN

FINISHES

Metal: Shade:
 Nickel White
 Black

MATERIALS

Steel / Fabric / Acrylic

SPECIFICATIONS (UE)

E14 - 2 x Max. 40W
 (Not included)
 220-240 V, 50/60 Hz
 IP20, Class II



ENERGY LABEL
 A ++

SHADE INCLUDED

RECOMMENDED BULBS
 B116-2 (5W)

TEC

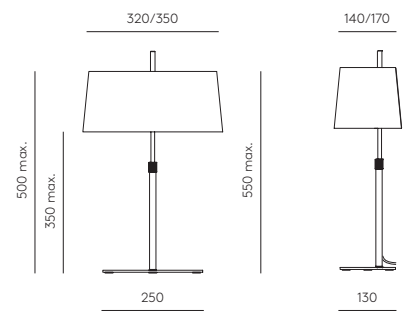



TORNO

DESIGNED BY AC STUDIO, 2013 · S1027

ES

ACABADOS

Metal: Blanco Mate
Negro Mate

Madera: Blanco Mate
Negro Mate

MATERIALES

Acero / Pino

ESPECIFICACIONES (UE)

E27 Max. 60W (No incluida)
220-240 V, 50/60 Hz
IP20, Clase II



CLASIFICACIÓN ENERGÉTICA

A ++

MODIFICACIONES POSIBLES

Pantalla imagen 801011/41
Pantalla no incluida

BOMBILLA RECOMENDADA

B211 (7, 9, 11W)

EN

FINISHES

Metal: Matt White
Matt Black

Wood: Matt White
Matt Black

MATERIALS

Steel / Pine

SPECIFICATIONS (UE)

E27 Max. 60W (Not included)
220-240 V, 50/60 Hz
IP20, Class II



ENERGY LABEL

A ++

POSSIBLE MODIFICATIONS

Image reference shade 801011/41
Shade not included

RECOMMENDED BULBS

B211 (7, 9, 11W)

TEC

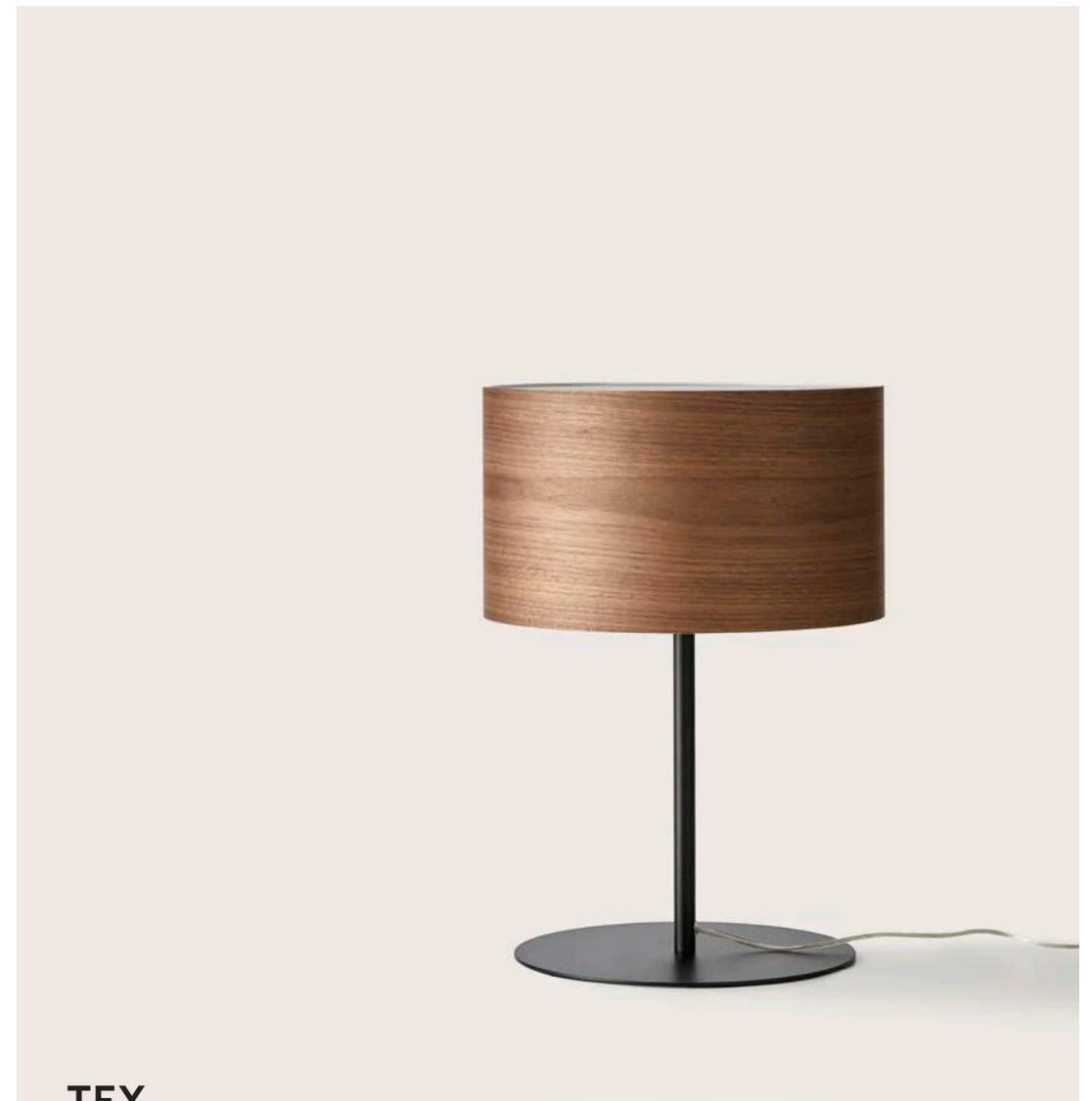
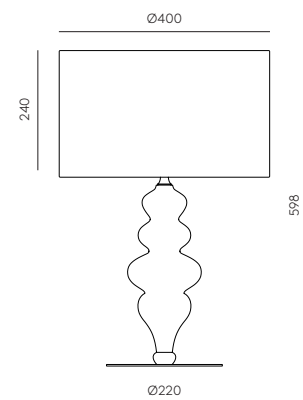

TEX

DESIGNED BY AC STUDIO, 2012 · S1026

ES

ACABADOS

Metal: Blanco Mate
Negro Mate

MATERIALES

Acero

ESPECIFICACIONES (UE)

E27 Max. 60W (No incluida)
220-240 V, 50/60 Hz
IP20, Clase II



CLASIFICACIÓN ENERGÉTICA

A ++

MODIFICACIONES POSIBLES

Pantalla imagen 801127/40/MAR
Pantalla no incluida

BOMBILLA RECOMENDADA

B211 (7, 9, 11W)

EN

FINISHES

Metal: Matt White
Matt Black

MATERIALS

Steel

SPECIFICATIONS (UE)

E27 Max. 60W (Not included)
220-240 V, 50/60 Hz
IP20, Class II



ENERGY LABEL

A ++

POSSIBLE MODIFICATIONS

Image reference shade 801127/40/MAR
Shade not included

RECOMMENDED BULBS

B211 (7, 9, 11W)

TEC

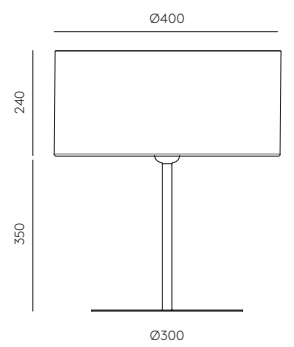



ENA

DESIGNED BY AC STUDIO, 2020 · NAC121

ES

ACABADOS

Metal:
Negro
Blanco
Oro mate / brillo
Cromo

Cerámica:
Miel

MATERIALES

Metal / Cerámica

ESPECIFICACIONES (UE)

E27 max. 60W (No incluida)
220-240 V, 50/60 Hz

IP20    

PANTALLA 801011/46 NO INCLUIDA

CLASIFICACIÓN ENERGÉTICA

A ++

MODIFICACIONES POSIBLES

Possibility of manufacturing in más colores de la carta en la pág. 372

EN

FINISHES

Metal:
Matt black
Matt white
Matt Brass / Shiny Gold
Chrome

Ceramic:
Honey

MATERIALS

Steel / Ceramic

SPECIFICATIONS (UE)

E27 max. 60W (Not included)
220-240 V, 50/60 Hz

IP20    

SHADE 801011/46 NOT INCLUDED

ENERGY LABEL

A ++

POSSIBLE MODIFICATIONS

Possibility of manufacturing in more colors check on color palette on page. 372

TEC

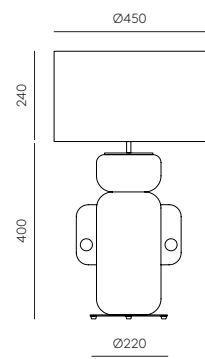

BOYA

DESIGNED BY AC STUDIO · NAC120

ES

ACABADOS

Metal:
Negro
Blanco
Oro mate / brillo
Cromo

Cristal:
Canyan Clay

MATERIALES

Metal / Cristal

ESPECIFICACIONES (UE)

E27 max. 60W (No incluida)
220-240 V, 50/60 Hz

IP20    

PANTALLA NO INCLUIDA

PANTALLA RECOMENDADA

801011/41

CLASIFICACIÓN ENERGÉTICA

A ++

MODIFICACIONES POSIBLES

Possibility of manufacturing in más colores de la carta en la pág.372

EN

FINISHES

Metal:
Matt black
Matt white
Matt Brass / Shiny Gold
Chrome

Glass:
Canyan Clay

MATERIALS

Steel / Glass

SPECIFICATIONS (UE)

E27 max. 60W (Not included)
220-240 V, 50/60 Hz

IP20    

SHADE NOT INCLUDED

RECOMMENDED SHADE

801011/41

ENERGY LABEL

A ++

POSSIBLE MODIFICATIONS

Possibility of manufacturing in more colors check on color palette on page. 372

TEC

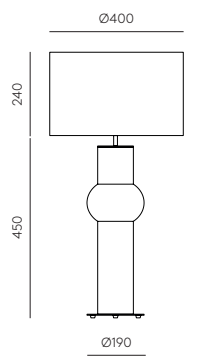



ADON

DESIGNED BY AC STUDIO, 2020 · NAC119

ES

ACABADOS

Metal: Negro
Blanco
Oro mate / brillo
Cromo

Cerámica: Terracota

MATERIALES

Metal / Cerámica

ESPECIFICACIONES (UE)

E27 max. 60W (No incluida)
220-240 V, 50/60 Hz

IP20

PANTALLA 801125/40/NEG NO INCLUIDA

CLASIFICACIÓN ENERGÉTICA

A ++

MODIFICACIONES POSIBLES

Posibilidad de fabricar en más colores de la carta en la pág. 372

EN

FINISHES

Metal: Matt black
Matt white
Matt Brass / Shiny Gold
Chrome

Ceramic: Terracotta

MATERIALS

Steel / Ceramic

SPECIFICATIONS (UE)

E27 max. 60W (Not included)
220-240 V, 50/60 Hz

IP20

SHADE 801125/40/NEG NOT INCLUDED

ENERGY LABEL

A ++

POSSIBLE MODIFICATIONS

Possibility of manufacturing in more colors check on color palette on page. 372

TEC

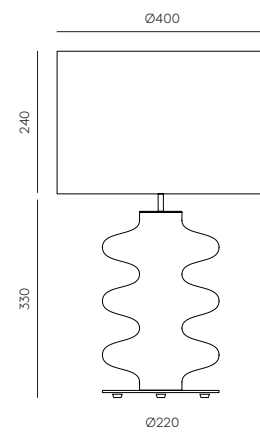

HOME

DESIGNED BY PEPE FORNAS, 2019 · NAC118

ES

ACABADOS

Metal: Negro
Blanco
Oro mate / brillo
Cromo

Cerámica: Gris Ceniza

MATERIALES

Acero / Cerámica

ESPECIFICACIONES (UE)

E27 Max. 60W (No incluida)
220-240 V, 50/60 Hz, IP20, Clase II

SHADE 801011/41 NO INCLUIDA

CLASIFICACIÓN ENERGÉTICA

A ++

MODIFICACIONES POSIBLES

Posibilidad de fabricar en más colores de la carta en la pág.372

EN

FINISHES

Metal: Matt black
Matt white
Matt Brass / Shiny Gold
Chrome

Ceramic: Ash grey

MATERIALS

Steel / Ceramic

SPECIFICATIONS (UE)

E27 Max. 60W (Not included)
220-240 V, 50/60 Hz, IP20, Class II

SHADE 801011/41 NOT INCLUDED

ENERGY LABEL

A ++

POSSIBLE MODIFICATIONS

Possibility of manufacturing in more colors check on color palette on page 372

TEC

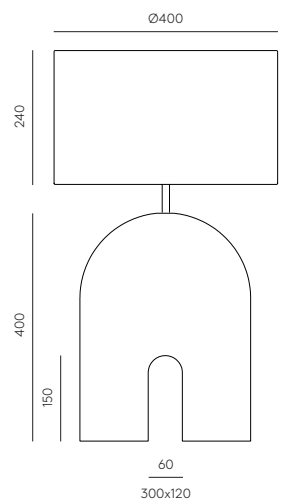



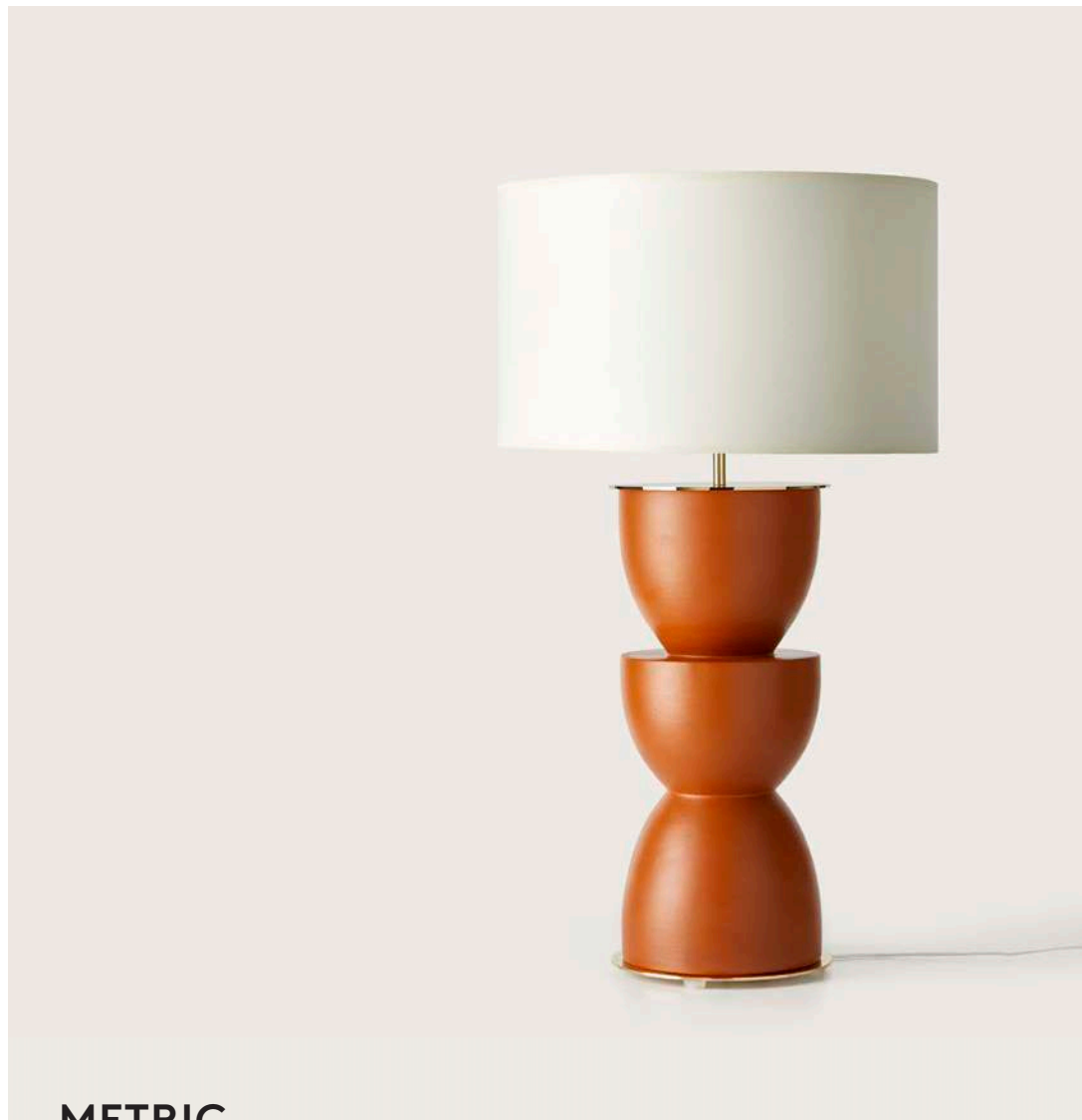

METRIC

DESIGNED BY PEPE FORNAS, 2019 · NAC117

ES

ACABADOS

Metal:
Negro
Blanco
Oro mate / brillo
Cromo

Cerámica:
Teja

MATERIALES

Acero / Cerámica

ESPECIFICACIONES (UE)

E27 Max. 60W (No incluida)
220-240 V, 50/60 Hz, IP20, Clase II



CLASIFICACIÓN ENERGÉTICA

A ++

MODIFICACIONES POSIBLES

Posibilidad de fabricar en más colores de la carta en la pág.372. Para otros acabados consultar pantalla VCROR/41. Pantalla no incluida.

EN

FINISHES

Metal:
Matt black
Matt white
Matt Brass / Shiny Gold
Chrome

Ceramic:
Tile

MATERIALS

Steel / Ceramic

SPECIFICATIONS (UE)

E27 Max. 60W (Not included)
220-240 V, 50/60 Hz, IP20, Class II



ENERGY LABEL

A ++

POSSIBLE MODIFICATIONS

Possibility of manufacturing in more colors check on color palette on page 372. For other colors ask us image reference shade VCROR/41. Shade not included.

TEC

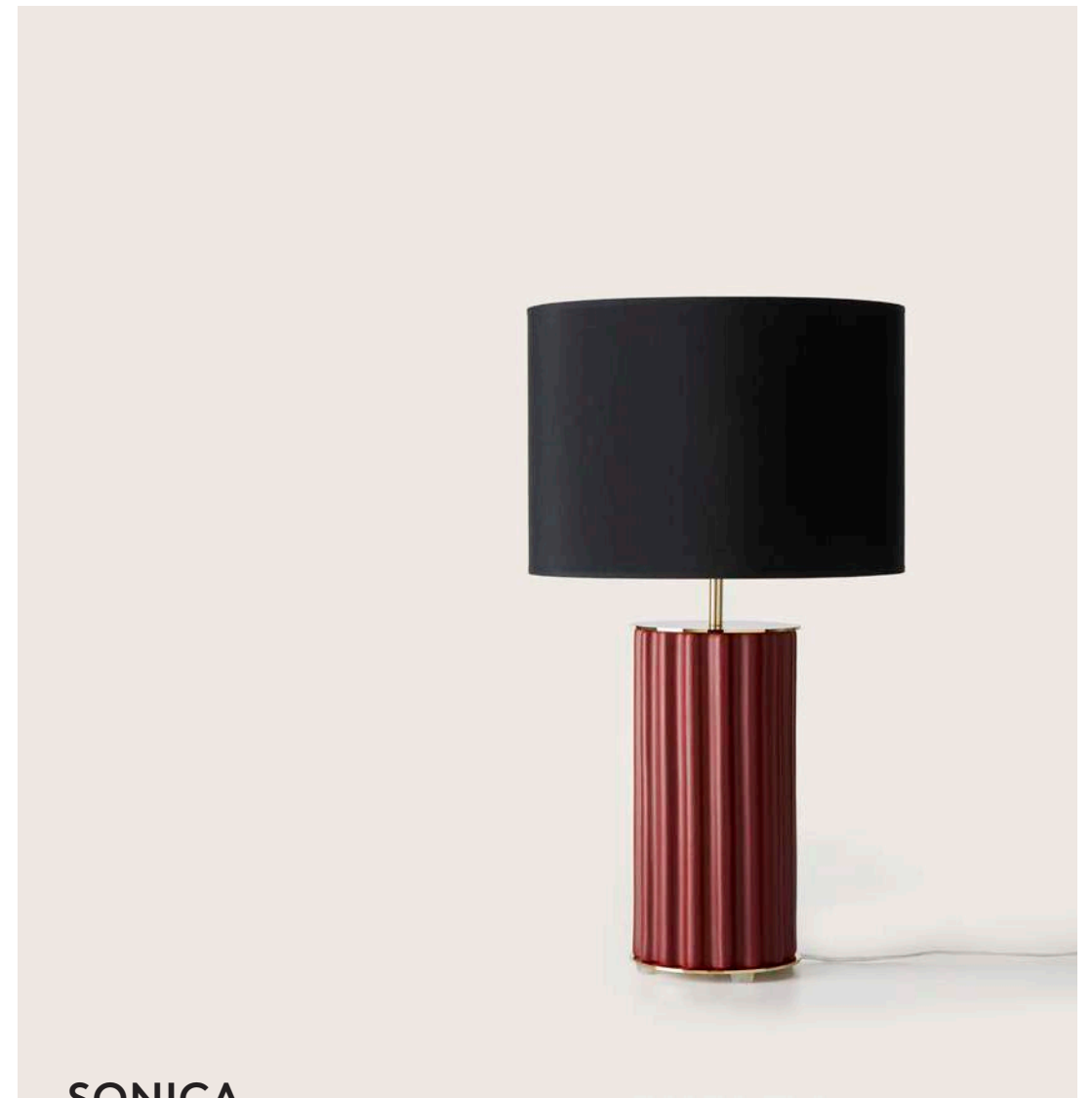
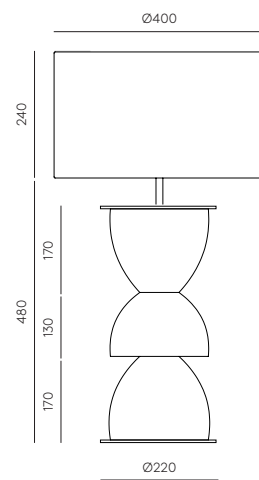

SONICA

DESIGNED BY AC STUDIO, 2019 · NAC116

ES

ACABADOS

Metal:
Negro
Blanco
Oro mate / brillo
Cromo

Cerámica:
Granate

MATERIALES

Acero / Cerámica

ESPECIFICACIONES (UE)

E27 Max. 60W (No incluida)
220-240 V, 50/60 Hz, IP20, Clase II



CLASIFICACIÓN ENERGÉTICA

A ++

MODIFICACIONES POSIBLES

Posibilidad de fabricar en más colores de la carta en la pág.372. Para otros acabados consultar pantalla imagen 801021/36. Pantalla no incluida.

EN

FINISHES

Metal:
Matt black
Matt white
Matt Brass / Shiny Gold
Chrome

Ceramic:
Maroon

MATERIALS

Steel / Ceramic

SPECIFICATIONS (UE)

E27 Max. 60W (Not included)
220-240 V, 50/60 Hz, IP20, Class II



ENERGY LABEL

A ++

POSSIBLE MODIFICATIONS

Possibility of manufacturing in more colors check on color palette on page 372. For other colors ask us image reference shade 801021/36. Shade not included.

TEC

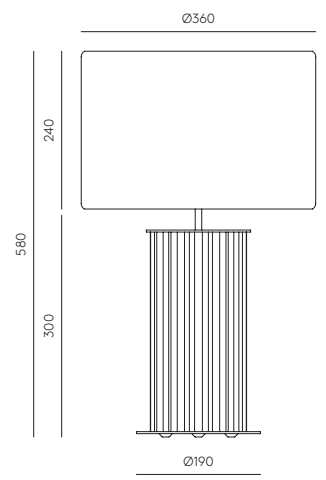



ONICA

DESIGNED BY AC STUDIO, 2019 · NAC114

ES

ACABADOS

Metal:
Negro
Blanco
Oro mate / brillo
Cromo

Cerámica:
Topo

MATERIALES

Acero / Cerámica

ESPECIFICACIONES (UE)

E27 Max. 60W (No incluida)
220-240 V, 50/60 Hz, IP20, Clase II



CLASIFICACIÓN ENERGÉTICA

A ++

MODIFICACIONES POSIBLES

Posibilidad de fabricar en más colores de la carta en la pág. 372. Para otros acabados consultar pantalla imagen 801011/41. Pantalla no incluida.

EN

FINISHES

Metal:
Matt black
Matt white
Matt Brass / Shiny Gold
Chrome

Ceramic:
Taupe

MATERIALS

Steel / Ceramic

SPECIFICATIONS (UE)

E27 Max. 60W (Not included)
220-240 V, 50/60 Hz, IP20, Class II



ENERGY LABEL

A ++

POSSIBLE MODIFICATIONS

Possibility of manufacturing in more colors check on color palette on page 372. For other colors ask us image reference shade 801011/41. Shade not included.

TEC

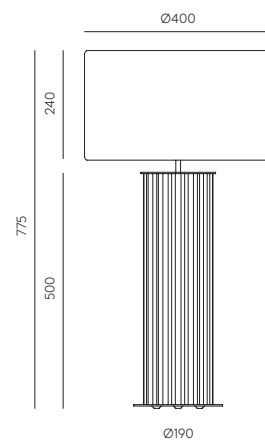

ATINA

DESIGNED BY AC STUDIO, 2019 · NAC115

ES

ACABADOS

Metal:
Negro
Blanco
Oro mate / brillo
Cromo

Cristal:
Gris ceniza

MATERIALES

Acero / Vidrio

ESPECIFICACIONES (UE)

E27 Max. 60W (No incluida)
220-240 V, 50/60 Hz, IP20, Clase II



CLASIFICACIÓN ENERGÉTICA

A ++

MODIFICACIONES POSIBLES

Posibilidad de fabricar en más colores de la carta en la pág.372. Para otros acabados consultar pantalla imagen 801021/35. Pantalla no incluida.

EN

FINISHES

Metal:
Matt black
Matt white
Matt Brass / Shiny Gold
Chrome

Glass:
Ash Grey

MATERIALS

Steel / Vidrio

SPECIFICATIONS (UE)

E27 Max. 60W (Not included)
220-240 V, 50/60 Hz, IP20, Class II

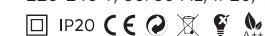

ENERGY LABEL

A ++

POSSIBLE MODIFICATIONS

Possibility of manufacturing in more colors check on color palette on page 372. For other colors ask us image reference shade 801021/35. Shade not included.

TEC

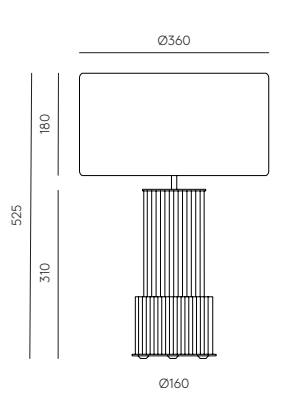





TARO

DESIGNED BY AC STUDIO, 2019 · NAC113

ES

ACABADOS

Metal:
Negro
Blanco
Oro mate / brillo
Cromo

Cerámica:
Verde Hoja

MATERIALES

Acero / Cerámica

ESPECIFICACIONES (UE)

E27 Max. 60W (No incluida)
220-240 V, 50/60 Hz, IP20, Clase II



CLASIFICACIÓN ENERGÉTICA

A ++

MODIFICACIONES POSIBLES

Posibilidad de fabricar en más colores de la carta en la pág. 372. Para otros acabados consultar pantalla imagen 801021/41. Pantalla no incluida.

EN

FINISHES

Metal:
Matt black
Matt white
Matt Brass / Shiny Gold
Chrome

Ceramic:
Green Leaf

MATERIALS

Steel / Ceramic

SPECIFICATIONS (UE)

E27 Max. 60W (Not included)
220-240 V, 50/60 Hz, IP20, Class II



ENERGY LABEL

A ++

POSSIBLE MODIFICATIONS

Possibility of manufacturing in more colors check on color palette on page 372. For other colors ask us image reference shade 801021/41. Shade not included.

TEC

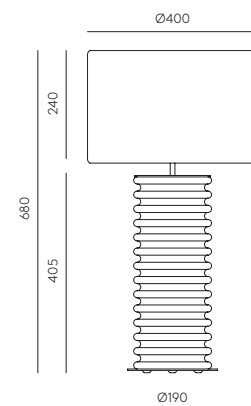

SHADOW

DESIGNED BY AC STUDIO, 2019 · NAC112

ES

ACABADOS

Metal:
Negro
Blanco
Oro mate / brillo
Cromo

Cristal:
Transparente

MATERIALES

Acero / Vidrio

ESPECIFICACIONES (UE)

E27 Max. 60W (No incluida)
220-240 V, 50/60 Hz, IP20, Clase II

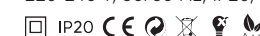

CLASIFICACIÓN ENERGÉTICA

A ++

MODIFICACIONES POSIBLES

Posibilidad de fabricar en fumé. Para otros acabados consultar pantalla imagen 801011/36. Pantalla no incluida.

EN

FINISHES

Metal:
Matt black
Matt white
Matt Brass / Shiny Gold
Chrome

Glass:
Clear

MATERIALS

Steel / Glass

SPECIFICATIONS (UE)

E27 Max. 60W (Not included)
220-240 V, 50/60 Hz, IP20, Class II

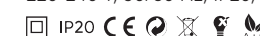

ENERGY LABEL

A ++

POSSIBLE MODIFICATIONS

Possibility of manufacturing in fumé. For other colors ask us image reference shade 801011/36. Shade not included.

TEC

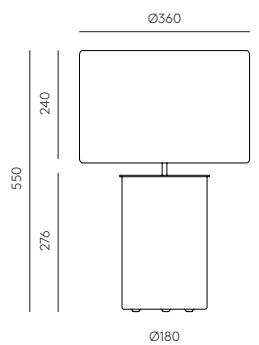





NOA

DESIGNED BY AC STUDIO, 2016 · NAC110

ES

ACABADOS

Metal:
Negro
Blanco
Oro mate / brillo
Cromo

Cristal:
Azul México

MATERIALES

Acero / Cerámica

ESPECIFICACIONES (UE)

E27 Max. 60W (No incluida)
220-240 V, 50/60 Hz, IP20, Clase II



CLASIFICACIÓN ENERGÉTICA

A ++

MODIFICACIONES POSIBLES

Posibilidad de fabricar en más colores de la carta en la pág. 372. Para otros acabados consultar pantalla imagen 801011/41. Pantalla no incluida.

EN

FINISHES

Metal:
Matt black
Matt white
Matt Brass / Shiny Gold
Chrome

Glass:
Mexico Blue

MATERIALS

Steel / Ceramic

SPECIFICATIONS (UE)

E27 Max. 60W (Not included)
220-240 V, 50/60 Hz, IP20, Class II



ENERGY LABEL

A ++

POSSIBLE MODIFICATIONS

Possibility of manufacturing in more colors check on color palette on page 372. For other colors ask us image reference shade 801011/41. Shade not included.

TEC

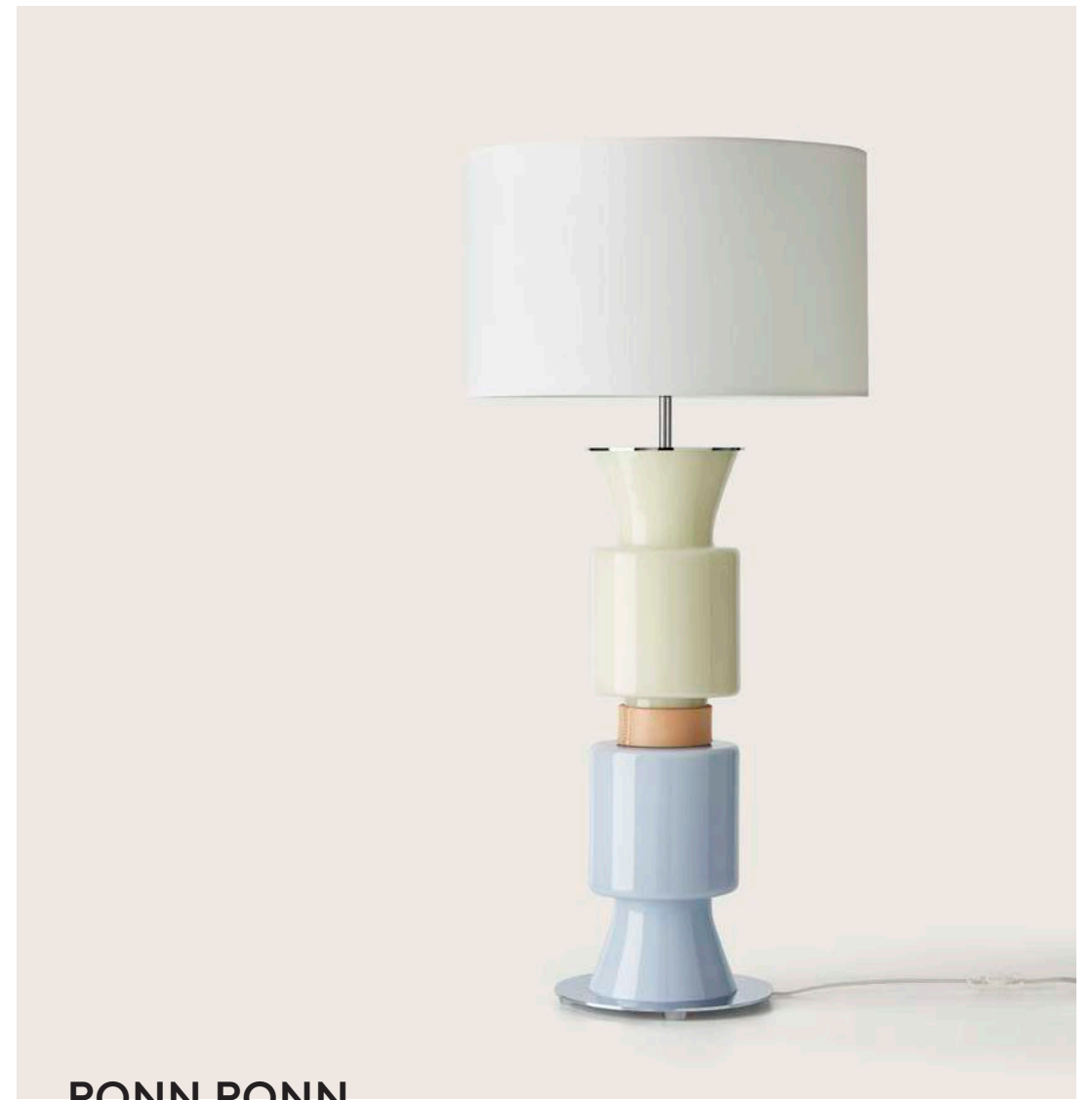
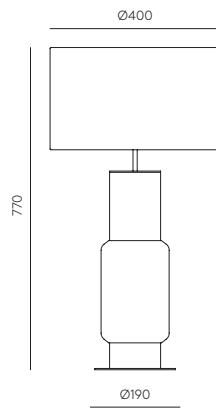

PONN PONN

DESIGNED BY AC STUDIO, 2016 · NAC109

ES

ACABADOS

Metal:
Negro
Blanco
Oro mate / brillo
Cromo

Cristal:
Arriba Soft Yellow
Abajo Serenity

MATERIALES

Acero / Vidrio / Cuero

ESPECIFICACIONES (UE)

E27 Max. 60W (No incluida)
220-240 V, 50/60 Hz, IP20, Clase II

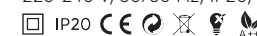

CLASIFICACIÓN ENERGÉTICA

A ++

MODIFICACIONES POSIBLES

Posibilidad de fabricar en más colores de la carta en la pág. 372. Para otros acabados consultar pantalla imagen 801011/41. Pantalla no incluida.

EN

FINISHES

Metal:
Matt black
Matt white
Matt Brass / Shiny Gold
Chrome

Glass:
Up Soft Yellow
Down Serenity

MATERIALS

Steel / Glass / Leather

SPECIFICATIONS (UE)

E27 Max. 60W (Not included)
220-240 V, 50/60 Hz, IP20, Class II

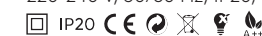

ENERGY LABEL

A ++

POSSIBLE MODIFICATIONS

Possibility of manufacturing in more colors check on color palette on page 372. For other colors ask us image reference shade 801011/41. Shade not included.

TEC

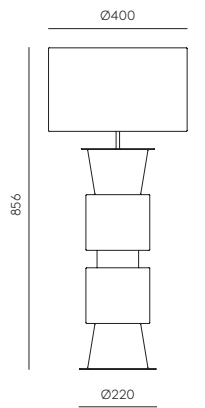



KITTA KITTA

DESIGNED BY AC STUDIO, 2016 · NAC108

ES

ACABADOS

Metal:
Negro
Blanco
Oro mate / brillo
Cromo

Cristal:
Arriba Topo
Abajo Canyon Clay

MATERIALES

Acero / Vidrio / Cuero

ESPECIFICACIONES (UE)

E27 Max. 60W (No incluida)
220-240 V, 50/60 Hz, IP20, Clase II



CLASIFICACIÓN ENERGÉTICA

A ++

MODIFICACIONES POSIBLES

Posibilidad de fabricar en más colores de la carta en la pág. 372.
Para otros acabados consultar pantalla imagen 801011/41.
Pantalla no incluida.

EN

FINISHES

Metal:
Matt black
Matt white
Matt Brass / Shiny Gold
Chrome

Glass:
Up Taupe
Down Canyon Clay

MATERIALES

Steel / Glass / Leather

SPECIFICATIONS (UE)

E27 Max. 60W (Not included)
220-240 V, 50/60 Hz, IP20, Class II



ENERGY LABEL

A ++

POSSIBLE MODIFICATIONS

Possibility of manufacturing in more colors check on color palette on page 372.
For other colors ask us image reference shade 801011/41.
Shade not included.

TEC

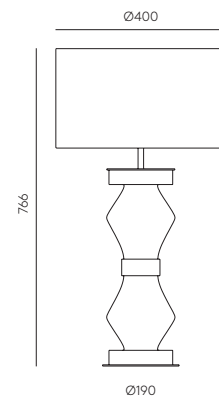

KITTA PONN

DESIGNED BY AC STUDIO, 2016 · NAC107

ES

ACABADOS

Metal:
Negro
Blanco
Oro mate / brillo
Cromo

Cristal:
Arriba Serenity
Abajo Gris Ceniza

MATERIALES

Acero / Vidrio / Cuero

ESPECIFICACIONES (UE)

E27 Max. 60W (No incluida)
220-240 V, 50/60 Hz, IP20, Clase II



CLASIFICACIÓN ENERGÉTICA

A ++

MODIFICACIONES POSIBLES

Posibilidad de fabricar en más colores de la carta en la pág. 372.
Para otros acabados consultar pantalla imagen 801011/40.
Pantalla no incluida.

EN

FINISHES

Metal:
Matt black
Matt white
Matt Brass / Shiny Gold
Chrome

Glass:
Up Serenity
Down Ash Grey

MATERIALES

Steel / Glass / Leather

SPECIFICATIONS (UE)

E27 Max. 60W (Not included)
220-240 V, 50/60 Hz, IP20, Class II



ENERGY LABEL

A ++

POSSIBLE MODIFICATIONS

Possibility of manufacturing in more colors check on color palette on page 372.
For other colors ask us image reference shade 801011/40.
Shade not included.

TEC

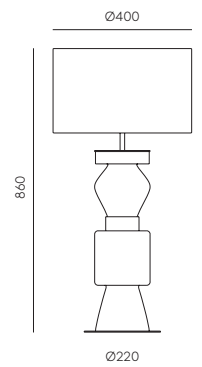





PONN

DESIGNED BY AC STUDIO, 2016 · NAC106

ES

ACABADOS

Metal: Negro
Blanco
Oro mate / brillo
Cromo

Cristal: Miel

MATERIALES

Acero / Vidrio

ESPECIFICACIONES (UE)

E27 Max. 60W (No incluida)
220-240 V, 50/60 Hz, IP20, Clase II



CLASIFICACIÓN ENERGÉTICA

A ++

MODIFICACIONES POSIBLES

Posibilidad de fabricar en más colores de la carta en la pág. 372. Para otros acabados consultar pantalla imagen 801011/36. Pantalla no incluida.

EN

FINISHES

Metal: Matt black
Matt white
Matt Brass / Shiny Gold
Chrome

Glass: Honey

MATERIALS

Steel / Glass

SPECIFICATIONS (UE)

E27 Max. 60W (Not included)
220-240 V, 50/60 Hz, IP20, Class II



ENERGY LABEL

A ++

POSSIBLE MODIFICATIONS

Possibility of manufacturing in more colors check on color palette on page 372. For other colors ask us image reference shade 801011/36. Shade not included.

TEC

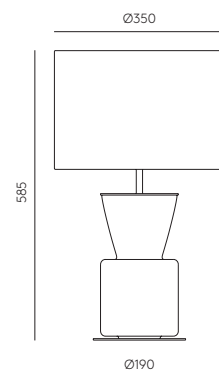

LUSA

DESIGNED BY AC STUDIO, 2016 · NAC104

ES

ACABADOS

Metal: Negro
Blanco
Oro mate / brillo
Cromo

Cristal: Topo

MATERIALES

Acero / Vidrio

ESPECIFICACIONES (UE)

E27 Max. 60W (No incluida)
220-240 V, 50/60 Hz, IP20, Clase II

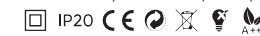

CLASIFICACIÓN ENERGÉTICA

A ++

MODIFICACIONES POSIBLES

Posibilidad de fabricar en más colores de la carta en la pág. 372. Para otros acabados consultar pantalla imagen 801011/36. Pantalla no incluida.

EN

FINISHES

Metal: Matt black
Matt white
Matt Brass / Shiny Gold
Chrome

Glass: Taupe

MATERIALS

Steel / Glass

SPECIFICATIONS (UE)

E27 Max. 60W (Not included)
220-240 V, 50/60 Hz, IP20, Class II

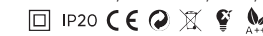

ENERGY LABEL

A ++

POSSIBLE MODIFICATIONS

Possibility of manufacturing in more colors check on color palette on page 372. For other colors ask us image reference shade 801011/36. Shade not included.

TEC

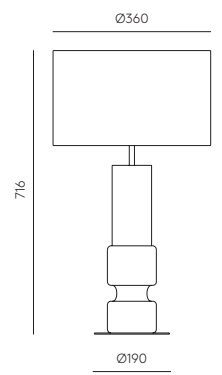

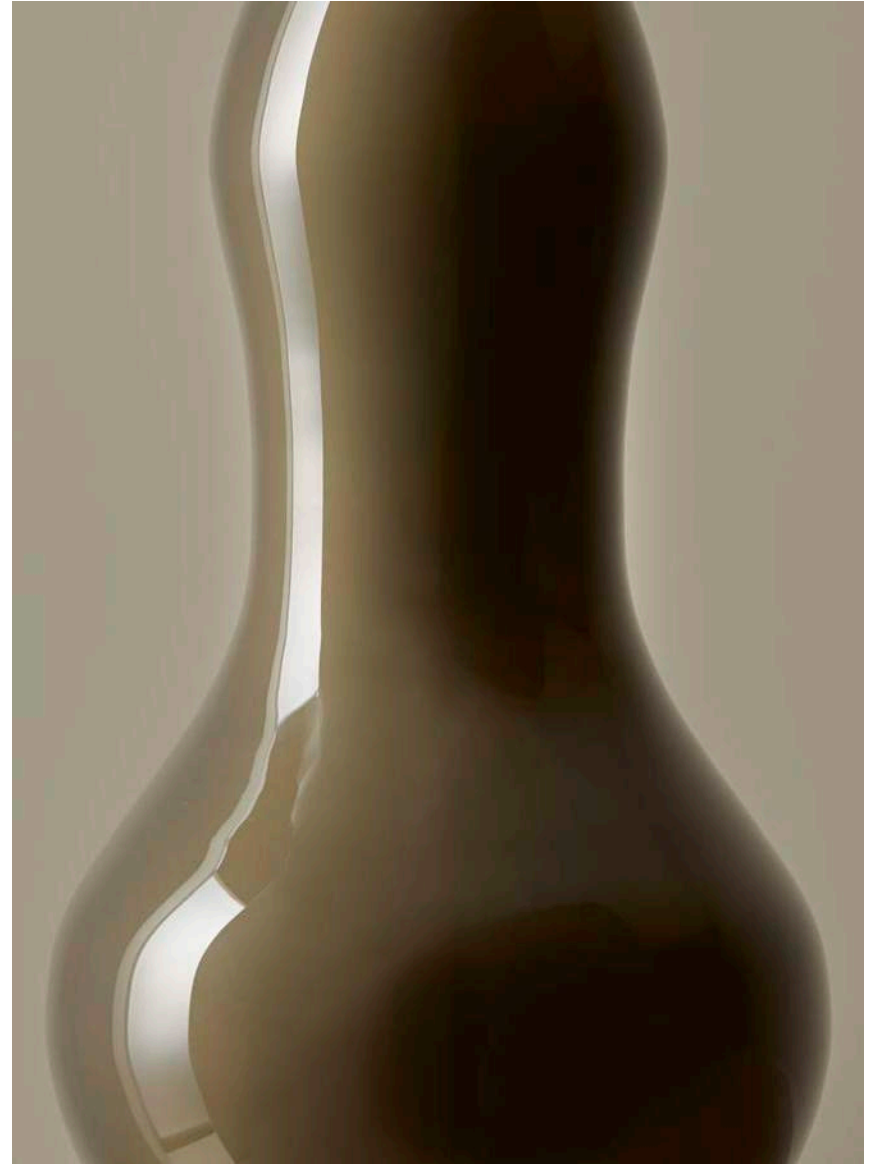



MELLY

DESIGNED BY AC STUDIO, 2015 · NAC103

ES

ACABADOS

Metal:
Negro
Blanco
Oro mate / brillo
Cromo

Cristal:
Verde Hoja

MATERIALES

Acero / Vidrio

ESPECIFICACIONES (UE)

E27 Max. 60W (No incluida)
220-240 V, 50/60 Hz, IP20, Clase II



CLASIFICACIÓN ENERGÉTICA

A ++

MODIFICACIONES POSIBLES

Posibilidad de fabricar en más colores de la carta en la pág. 372.
Para otros acabados consultar pantalla imagen 151011/45.
Pantalla no incluida.

EN

FINISHES

Metal:
Matt black
Matt white
Matt Brass / Shiny Gold
Chrome

Glass:
Green leaf

MATERIALS

Steel / Glass

SPECIFICATIONS (UE)

E27 Max. 60W (Not included)
220-240 V, 50/60 Hz, IP20, Class II



ENERGY LABEL

A ++

POSSIBLE MODIFICATIONS

Possibility of manufacturing in more colors check on color palette on page 372.
For other colors ask us image reference shade 151011/45.
Shade not included.

TEC

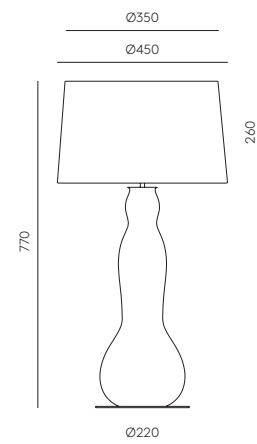

SAM

DESIGNED BY AC STUDIO, 2013 · NAC093

ES

ACABADOS

Madera:
Nogal

Cristal:
Marrón
Azul

MATERIALES

Acero / Vidrio / Madera

ESPECIFICACIONES (UE)

E27 Max. 60W (No incluida)
220-240 V, 50/60 Hz, IP20, Clase II



CLASIFICACIÓN ENERGÉTICA

A ++

MODIFICACIONES POSIBLES

Pantalla imagen 801011/46.
Pantalla no incluida.

EN

FINISHES

Wood:
Walnut

Glass:
Brown
Blue

MATERIALS

Steel / Glass / Wood

SPECIFICATIONS (UE)

E27 Max. 60W (Not included)
220-240 V, 50/60 Hz, IP20, Class II



ENERGY LABEL

A ++

POSSIBLE MODIFICATIONS

Image reference shade 801011/46.
Shade not included.

TEC

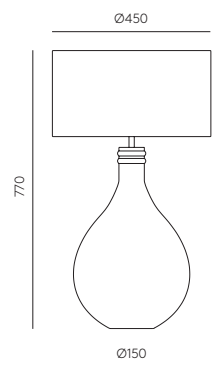

Pendant lamps

118	MIRO	152	ERTO	186	CUBE X
120	MIRO	153	ERTO	188	ANET
122	SONN	156	TINNO	189	MIKA MULTI
124	FITO	157	FRAME	190	MIKA
125	TANT	158	FICUS	191	LEJO
126	AMBOR	159	OHLALA	192	MARU
127	HUP	162	CRANE	193	DAMO
128	ATIL	164	LUCA +	194	LESS
130	ATIL	165	LUCA	196	DODO
131	DALT	166	LOTA	197	ELLA
132	DALT	168	LITA	198	ENDO
134	FOCUS	169	LITA	200	PTANT
135	FOCUS	172	NERA	202	ANYA
136	FOCUS	173	DORA	205	PAGO
138	NINO	174	ALOA L	206	HEDULA
140	LYB	175	ALOA	208	ALPHA
142	GAND	176	DELIE	209	BETA
144	COLN	178	DELIE	210	GAMMA
145	CLIP	179	FEST	212	ELLEN
146	ALMON	180	YOYO	213	CRAWFORD
147	ALMON	181	HELMET	214	DISC
148	WONG	182	LIND	216	OPEN
150	ABBACUS	183	BALL	217	C10-12
151	ABBACUS	184	ATOM	218	TAMB SQUARE
				219	TAMB 30-50



MIRO

DESIGNED BY AC STUDIO, 2021 - C1289/6

ES

ACABADOS
Metal: Negro Mate
Tulipas (Incluidas): Opal

MATERIALES
 Acero / Vidrio Soplado

ESPECIFICACIONES (UE)
 6 x G9 LED (incluidas) 5W 2700K
 220-240V, 50/60 Hz
 IP20, Clase I

⊕ IP20 CE ENEC A++

CLASIFICACIÓN ENERGÉTICA
 A ++

BOMBILLAS RECOMENDADAS
 B005/5W

ACCESORIOS COMPATIBLES (NO INCLUIDOS)
 Alabastro 1096 (20 ó 25 cm)
 Cerámica (20 ó 30 cm)
 Cristal 1223 (25 cm)
 Disco Metálico 1038 (15 ó 25 cm)

EN

FINISHES
Metal: Matt Black
Shades (included): Opal

MATERIALS
 Steel / Blown Glass

SPECIFICATIONS (UE)
 6 x G9 LED (included) 5W 2700K
 220-240V, 50/60 Hz
 IP20, Class I

⊕ IP20 CE ENEC A++

ENERGY LABEL
 A ++

RECOMMENDED BULB
 B005/5W

COMPATIBLE ACCESSORIES (NOT INCLUDED)
 Alabaster 1096 (20 ó 25 cm)
 Ceramic (20 ó 30 cm)
 Glass 1223 (25 cm)
 Metallic disc 1038 (15 ó 25 cm)

TEC

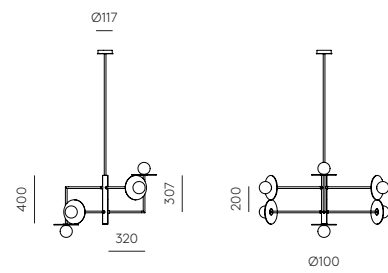
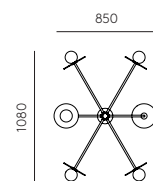



MIRO

DESIGNED BY AC STUDIO, 2021 - C1289

ES

ACABADOS
Metal: Negro Mate
Tulipa (incluida): Opal

MATERIALES
 Acero / Vidrio Soplado

ESPECIFICACIONES (UE)
 G9 LED (incluida) 5W 2700K
 220-240V, 50/60 Hz
 IP20, Clase I

⊕ IP20 CE ENEC A++

ACCESORIOS COMPATIBLES (NO INCLUIDOS)
 Alabastro 1096 (20 ó 25 cm)
 Cerámica (20 ó 30 cm)
 Cristal 1223 (25 cm)
 Disco Metálico 1038 (15 ó 25 cm)

CLASIFICACIÓN ENERGÉTICA
 A ++

BOMBILLA RECOMENDADA
 B005 / 5W

EN

FINISHES
Metal: Matt Brass
Shade (included): Opal

MATERIALS
 Steel / Blown Glass

SPECIFICATIONS (UE)
 E27 (Bulb not included)
 220-240 V, 50/60 Hz
 IP20, Class II

⊕ IP20 CE ENEC A++

COMPATIBLE ACCESSORIES (NOT INCLUDED)
 Alabaster 1096 (20 ó 25 cm)
 Ceramic (20 ó 30 cm)
 Glass 1223 (25 cm)
 Metallic disc 1038 (15 ó 25 cm)

ENERGY LABEL
 A ++

RECOMMENDED BULB
 B005 / 5W

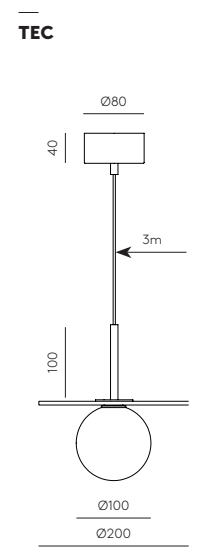



SONN

DESIGNED BY JF SEVILLA, 2020 · C1287

ES

ACABADOS
Metal Negro Mate Tulipas Opales / Transparentes

MATERIALES
Metal / Vidrio

ESPECIFICACIONES (UE)
6 x G9 LED 5W 2700K (Incluidas)
220-240 V, 50/60 Hz
IP20     

TULIPAS INCLUIDAS

CLASIFICACIÓN ENERGÉTICA
A ++

BOMBILLAS RECOMENDADAS
B005/5W

EN

FINISHES
Metal Matt black Glass shades Opal / Clear

MATERIALS
Metal / Glass

SPECIFICATIONS (UE)
6 x G9 LED 5W 2700K (Included)
220-240 V, 50/60 Hz
IP20     

GLASS SHADES INCLUDED

ENERGY LABEL
A ++

RECOMMENDED BULBS
B005/5W

TEC

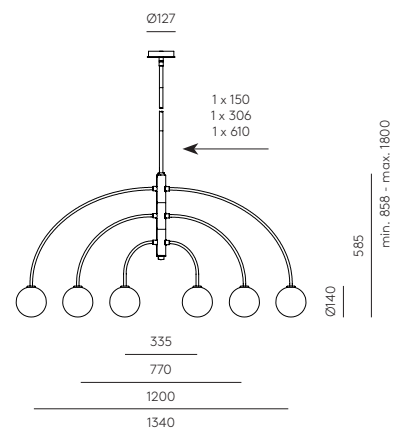



FITO

DESIGNED BY PEPE FORNAS, 2020 · C1286/50 - C1286/25

ES

ACABADOS

Base: Oro Mate Negro Mate
Rejilla: Oro Mate Blanco Mate

MATERIALES

Acero

ESPECIFICACIONES (UE)

E27 (Bombilla no incluida)
 220-240 V, 50/60 Hz
 IP20, Clase II



MEDIDAS TUBO REJILLA

C1285/50 - 50 cm
 C1285/25 - 25 cm

CLASIFICACIÓN ENERGÉTICA

A ++

BOMBILLA IMAGEN

B050

EN

FINISHES

Base: Matt Brass Matt Black
Rack: Matt Black Matt White

MATERIALS

Steel

SPECIFICATIONS (UE)

E27 (Bulb not included)
 220-240 V, 50/60 Hz
 IP20, Class II



SIZES RACK TUBE

C1285/50 - 50 cm
 C1285/25 - 25 cm

ENERGY LABEL

A ++

BULB IMAGE

B050

TEC

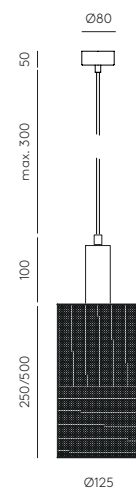

TANT

DESIGNED BY JF SEVILLA, 2020 · C1285 - C1284

ES

ACABADOS

Metal: Oro Mate Negro Mate
Ratán: Natural Natural

MATERIALES

Acero / Ratán

ESPECIFICACIONES (UE)

C1285 (Ovalada)
 Tira Led 18W
 3000K - 2m cable
C1284 (Redonda)
 Tira Led 16W
 3000K - 2m cable
 24-240 V, 50/60 Hz
 IP20, Clase I



CLASIFICACIÓN ENERGÉTICA

A ++

EN

FINISHES

Metal: Oro Mate Negro Mate
Rattan: Natural Natural

MATERIALS

Steel / Rattan

SPECIFICATIONS (UE)

C1285 (Oval)
 Led strip 18W
 3000K - 2m cable
C1284 (Rounded)
 Led strip 16W
 3000K - 2m cable
 24-240 V, 50/60 Hz
 IP20, Class I



ENERGY LABEL

A ++

TEC

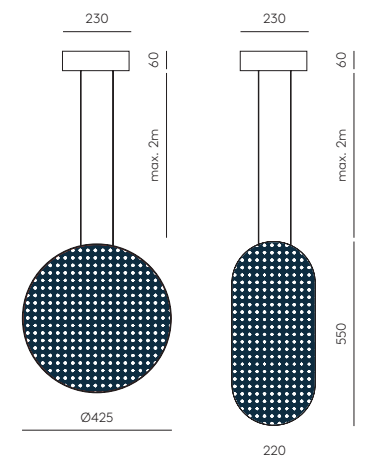



AMBOR

DESIGNED BY PEPE FORNAS, 2019 · C1283

ES

ACABADOS

Cable: Negro Mate
Tulipa / Base: Negro Mate / Oro Mate
Difusor: Opal

MATERIALES

Acero / Acrílico

ESPECIFICACIONES (UE)

Bombillas G9 Led (Incluidas)
 3 x 3W - 3000K
 220-240 V, 50/60 Hz, IP20,
 Clase I



CLASIFICACIÓN ENERGÉTICA

A ++

BOMBILLAS RECOMENDADAS

B005

EN

FINISHES

Cable: Matt Black
Shade / Base: Matt Black / Matt Brass
Difusor: Opal

MATERIALS

Steel / Acrylic

SPECIFICATIONS (UE)

G9 Led Bulbs (Included)
 3 x 3W - 3000K
 220-240 V, 50/60 Hz, IP20,
 Class I



ENERGY LABEL

A ++

RECOMMENDED BULBS

B005

TEC

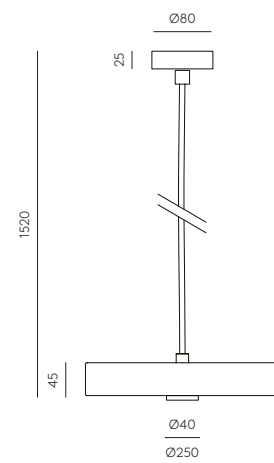

HUP

DESIGNED BY PEPE FORNAS, 2019 · C1282

ES

ACABADOS

Metal: Negro Mate / Oro Mate / Cromo
Tulipa: Opal

MATERIALES

Acero / Vidrio

ESPECIFICACIONES (UE)

E27 (No incluida)
 Max. 60W
 220-240 V, 50/60 Hz
 IP20, Clase I



CLASIFICACIÓN ENERGÉTICA

A ++

BOMBILLA RECOMENDADA

B211 (7, 9, 11W)

EN

FINISHES

Metal: Matt Black / Matt Brass / Chrome
Glass Shade: Opal

MATERIALS

Steel / Glass

SPECIFICATIONS (UE)

E27 (Not included)
 Max. 60W
 220-240 V, 50/60 Hz
 IP20, Class I



ENERGY LABEL

A ++

RECOMMENDED BULB

B211 (7, 9, 11W)

TEC

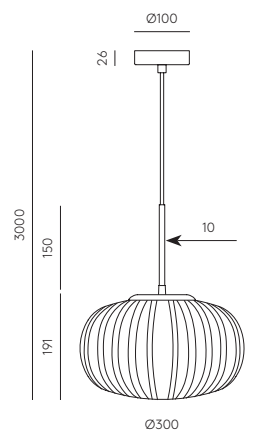

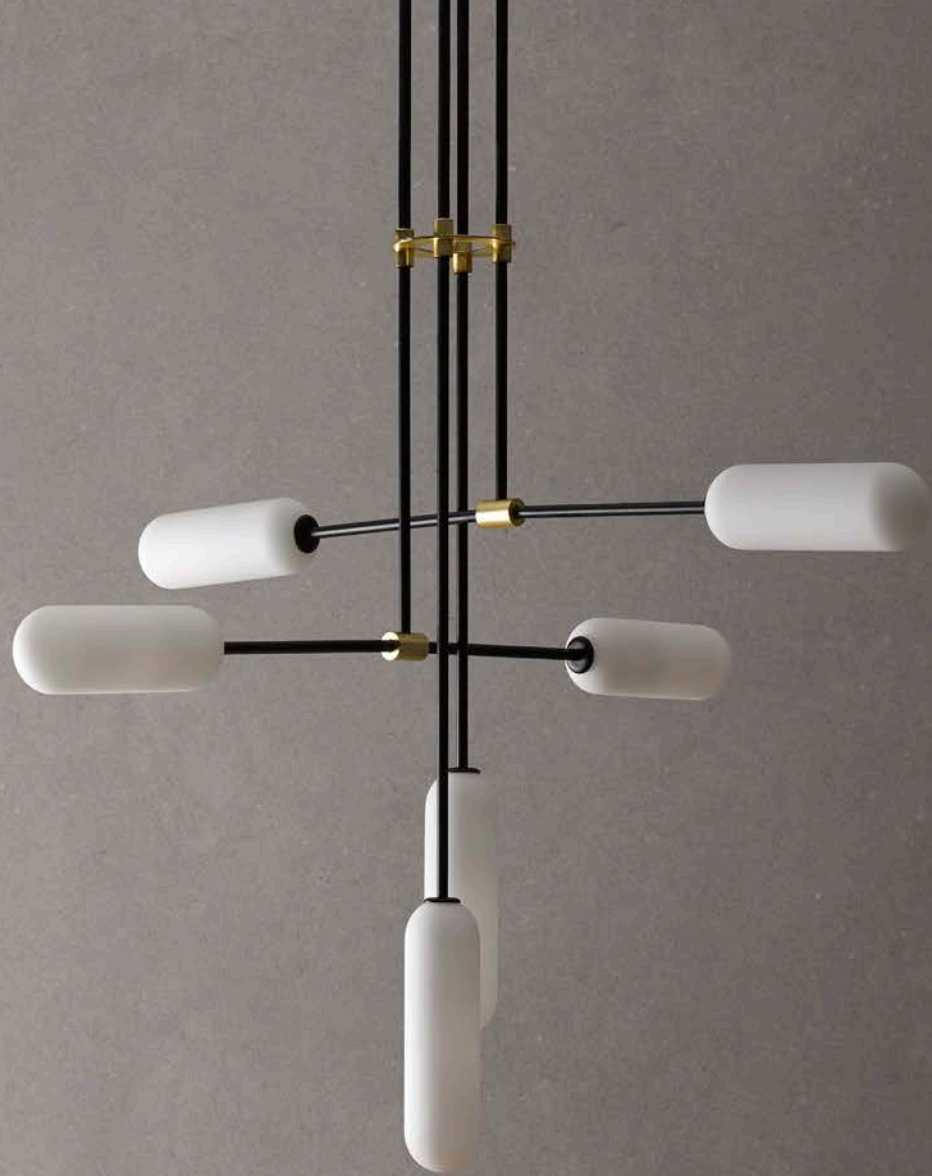

ATIL

DESIGNED BY PEPE FORNAS, 2019 · C1281/6

ES

ACABADOS

Metal:
Negro Mate
Oro Mate (detalles)

Tulipa:
Opal

MATERIALES

Acero / Vidrio

ESPECIFICACIONES (UE)

Bombillas G9 Led (Incluidas)
6 x 5W - 2700K
220-240 V, 50/60 Hz
IP20, Clase I



CLASIFICACIÓN ENERGÉTICA
A ++

BOMBILLAS RECOMENDADAS
B005/5W

EN

FINISHES

Metal:
Matt Black
Matt Brass (details)

Glass Shade:
Opal

MATERIALS

Steel / Glass

SPECIFICATIONS (UE)

Bulbs G9 Led (Included)
6 x 5W - 2700K
220-240 V, 50/60 Hz
IP20, Class I



ENERGY LABEL
A ++

RECOMMENDED BULBS
B005/5W

TEC

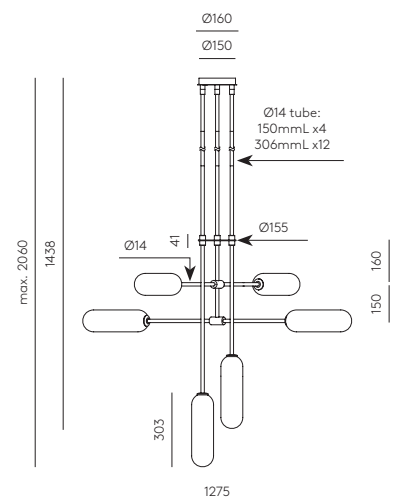



ATIL

DESIGNED BY PEPE FORNAS, 2019 · C1281

ES

ACABADOS

Metal:
Negro Mate
Oro Mate

Tulipa:
Opal
Opal

MATERIALES

Acero / Vidrio

ESPECIFICACIONES (UE)

Bombilla G9 Led (Incluida)
5W - 2700K
220-240 V, 50/60 Hz
IP20, Clase I



CLASIFICACIÓN ENERGÉTICA

A ++

BOMBILLAS RECOMENDADAS

B005/5W

EN

FINISHES

Metal:
Matt Black
Matt Brass

Glass Shade:
Opal
Opal

MATERIALS

Steel / Glass

SPECIFICATIONS (UE)

Bulb G9 Led (Included)
5W - 2700K
220-240 V, 50/60 Hz
IP20, Class I



ENERGY LABEL

A ++

RECOMMENDED BULBS

B005/5W

TEC

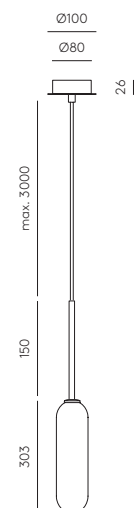

DALT

DESIGNED BY PEPE FORNAS, 2019 · C1280

ES

ACABADOS

Metal:
Negro Mate
Oro Envejecido
Negro Mate

Mármol:
Negro
Verde
Blanco

Tulipa:
Opal
Opal
Opal

MATERIALES

Acero / Mármol / Vidrio

ESPECIFICACIONES (UE)

Bombilla G9 Led (Incluidas)
5W - 3000K
220-240 V, 50/60 Hz
IP20, Clase I



CLASIFICACIÓN ENERGÉTICA

A ++

BOMBILLAS RECOMENDADAS

B005/5W

EN

FINISHES

Body:
Matt Black
Aged Gold
Matt Black

Marble:
Black
Green
White

Glass Shade:
Opal
Opal
Opal

MATERIALS

Steel / Marble / Glass

SPECIFICATIONS (UE)

Bulb G9 Led (Included)
5W - 3000K
220-240 V, 50/60 Hz
IP20, Class I



ENERGY LABEL

A ++

RECOMMENDED BULBS

B005/5W

TEC

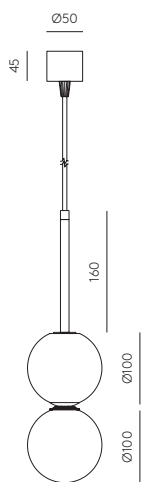



DALT

DESIGNED BY PEPE FORNAS, 2019 · C1280/6

ES

ACABADOS

Metal: Negro Mate, Negro, Oro Envejecido
Mármol: Negro, Verde
Tulipa: Opal, Opal

MATERIALES

Acero / Mármol / Vidrio

ESPECIFICACIONES (UE)

Bombillas G9 Led (Incluidas)
 6 x 5W - 3000K
 220-240 V, 50/60 Hz
 IP20, Clase I

IP20 CE RoHS ENEC

MODIFICACIONES POSIBLES

Acabado Mármol (blanco)

CLASIFICACIÓN ENERGÉTICA

A ++

BOMBILLAS RECOMENDADAS

B005/5W

EN

FINISHES

Body: Matt Black, Black, Aged Gold
Marble: Black, Green
Glass Shade: Opal, Opal

MATERIALS

Steel / Marble / Glass

SPECIFICATIONS (UE)

Bulbs G9 Led (Included)
 6 x 5W - 3000K
 220-240 V, 50/60 Hz
 IP20, Class I

IP20 CE RoHS ENEC

POSSIBLE MODIFICATIONS

Marble Finishes (white)

ENERGY LABEL

A ++

RECOMMENDED BULBS

B005/5W

TEC

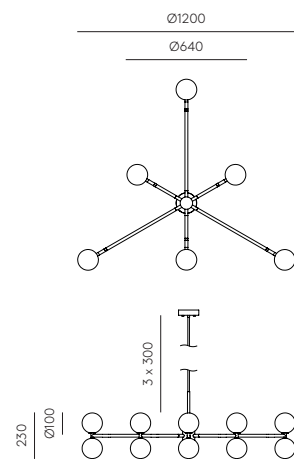



FOCUS

DESIGNED BY PEPE FORNAS, 2019 · C1279

ES

ACABADOS

Cuerpo: Negro Mate
Oro viejo
Plata Mate

Cabeza: Oro Viejo/Antracita
Alabastro
Alabastro

MATERIALES

Acero / Aluminio o Alabastro

ESPECIFICACIONES (UE)

Bombilla GU10 Led (Incluida)
5W - 3000K
220-240 V, 50/60 Hz
IP20, Clase I



CLASIFICACIÓN ENERGÉTICA

A ++

MODIFICACIONES POSIBLES

Cabezal Alabastro (Sobrecoste)

BOMBILLA RECOMENDADA

B161

EN

FINISHES

Body: Matt Black
Aged Gold
Matt Silver

Head: Aged Gold/ Anthracite
Alabaster
Alabastro

MATERIALS

Steel / Aluminium or Alabaster

SPECIFICATIONS (UE)

Bulb GU10 Led (Included)
5W - 3000K
220-240 V, 50/60 Hz
IP20, Class I



ENERGY LABEL

A ++

POSSIBLE MODIFICATIONS

Alabaster head (Extra charge)

RECOMMENDED BULB

B161

TEC

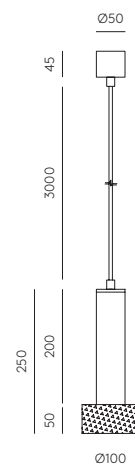

FOCUS

DESIGNED BY PEPE FORNAS, 2019 · C1279/1

ES

ACABADOS

Cuerpo: Negro Mate
Negro Mate
Negro Mate

Cabeza: Oro Viejo
Alabastro
Antracita

MATERIALES

Acero / Aluminio o Alabastro

ESPECIFICACIONES (UE)

Bombilla GU10 Led (Incluida)
5W - 3000K
220-240 V, 50/60 Hz
IP20, Clase I



CLASIFICACIÓN ENERGÉTICA

A ++

MODIFICACIONES POSIBLES

Cabezal Alabastro (Sobrecoste)

BOMBILLA RECOMENDADA

B161

EN

FINISHES

Body: Matt Black
Matt Black
Matt Black

Head: Aged Gold
Alabaster
Anthracite

MATERIALS

Steel / Aluminium or Alabaster

SPECIFICATIONS (UE)

Bulb GU10 Led (Included)
5W - 3000K
220-240 V, 50/60 Hz
IP20, Class I



ENERGY LABEL

A ++

POSSIBLE MODIFICATIONS

Alabaster head (Extra charge)

RECOMMENDED BULB

B161

TEC

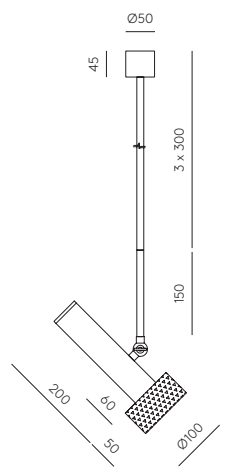

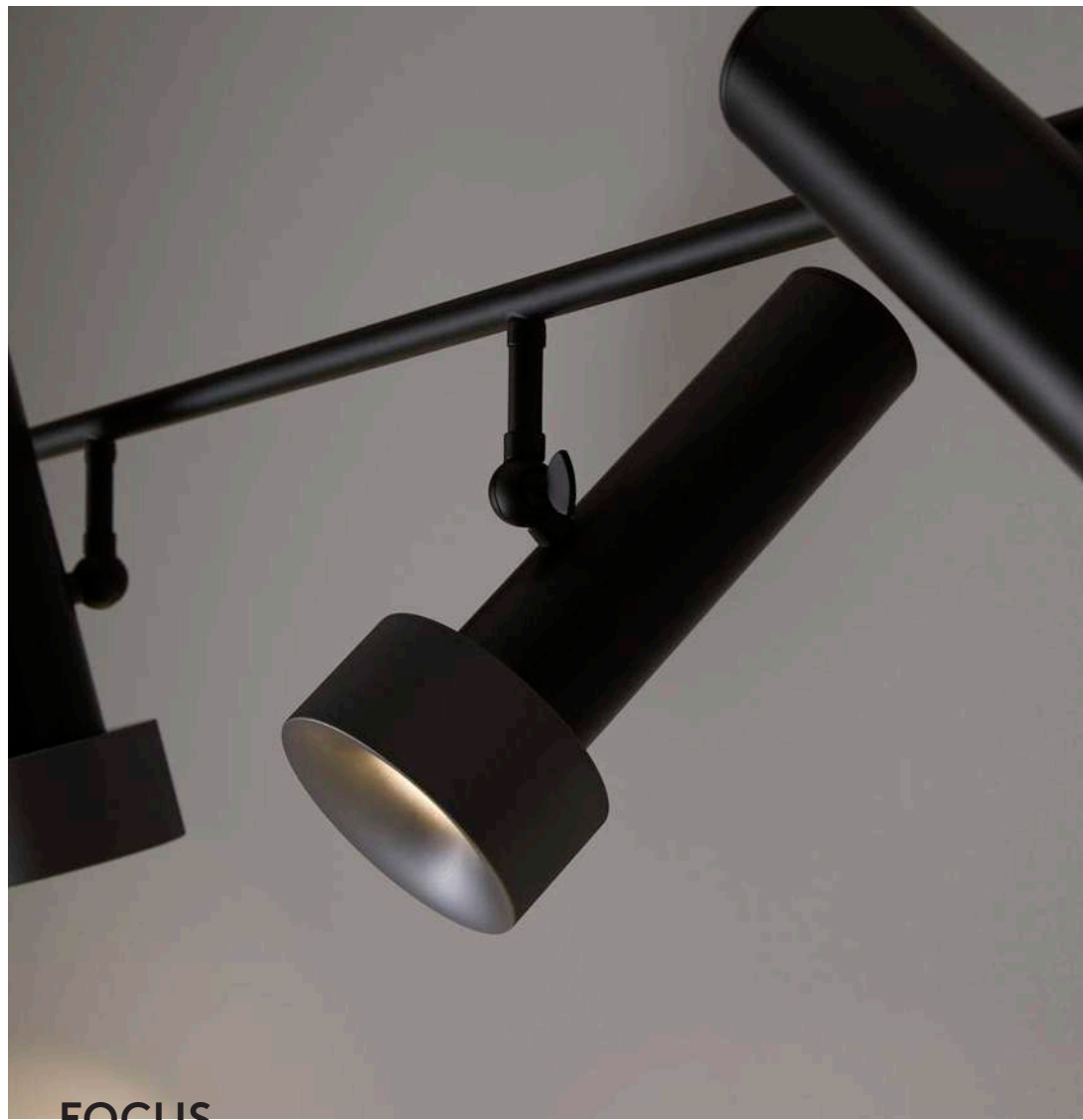

FOCUS

DESIGNED BY PEPE FORNAS, 2019 · C1279/4

ES

ACABADOS

Cuerpo: Cabeza:
 Negro Mate Oro Viejo
 Negro Mate Alabastro
 Negro Mate Antracita

MATERIALES

Acero / Aluminio o Alabastro

ESPECIFICACIONES (UE)

Bombilla GU10 Led (Incluida)
 4 x 5W - 3000K
 220-240 V, 50/60 Hz
 IP20, Clase I



CLASIFICACIÓN ENERGÉTICA

A ++

MODIFICACIONES POSIBLES

Cabezal Alabastro (Sobrecoste)

BOMBILLAS RECOMENDADAS

B161

EN

FINISHES

Body: Head:
 Matt Black Aged Gold
 Matt Black Alabaster
 Matt Black Anthracite

MATERIALS

Steel / Aluminium or Alabaster

SPECIFICATIONS (UE)

Bulb GU10 Led (Included)
 4 x 5W - 3000K
 220-240 V, 50/60 Hz
 IP20, Class I



ENERGY LABEL

A ++

POSSIBLE MODIFICATIONS

Alabaster head (Extra charge)

RECOMMENDED BULBS

B161

TEC

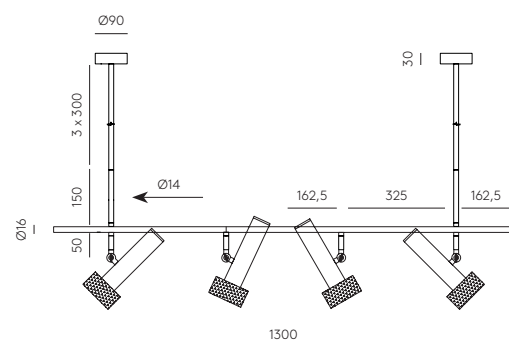



NINO

DESIGNED BY JF SEVILLA, 2021 - C1275

ES

ACABADOS
Metal: Negro Mate
 Oro Mate
Tulipa (Incluida): transparente

MATERIALES
 Acero / Vidrio óptico

ESPECIFICACIONES (UE)
 Placa Led (Incluida)
 7W - 2700K Regulable
 24 V, 50/60 Hz
 IP20, Clase I



CLASIFICACIÓN ENERGÉTICA
 A ++

EN

FINISHES
Metal: Matt Black
 Matt Brass
Shade (included): Transparent

MATERIALS
 Steel / Optical glass

SPECIFICATIONS (UE)
 Led Plate (Included)
 7W - 2700K Dimmable
 24 V, 50/60 Hz
 IP20, Class I



ENERGY LABEL
 A ++

TEC

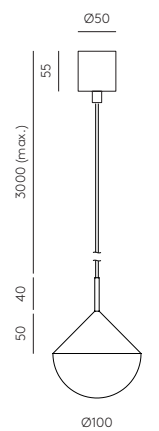

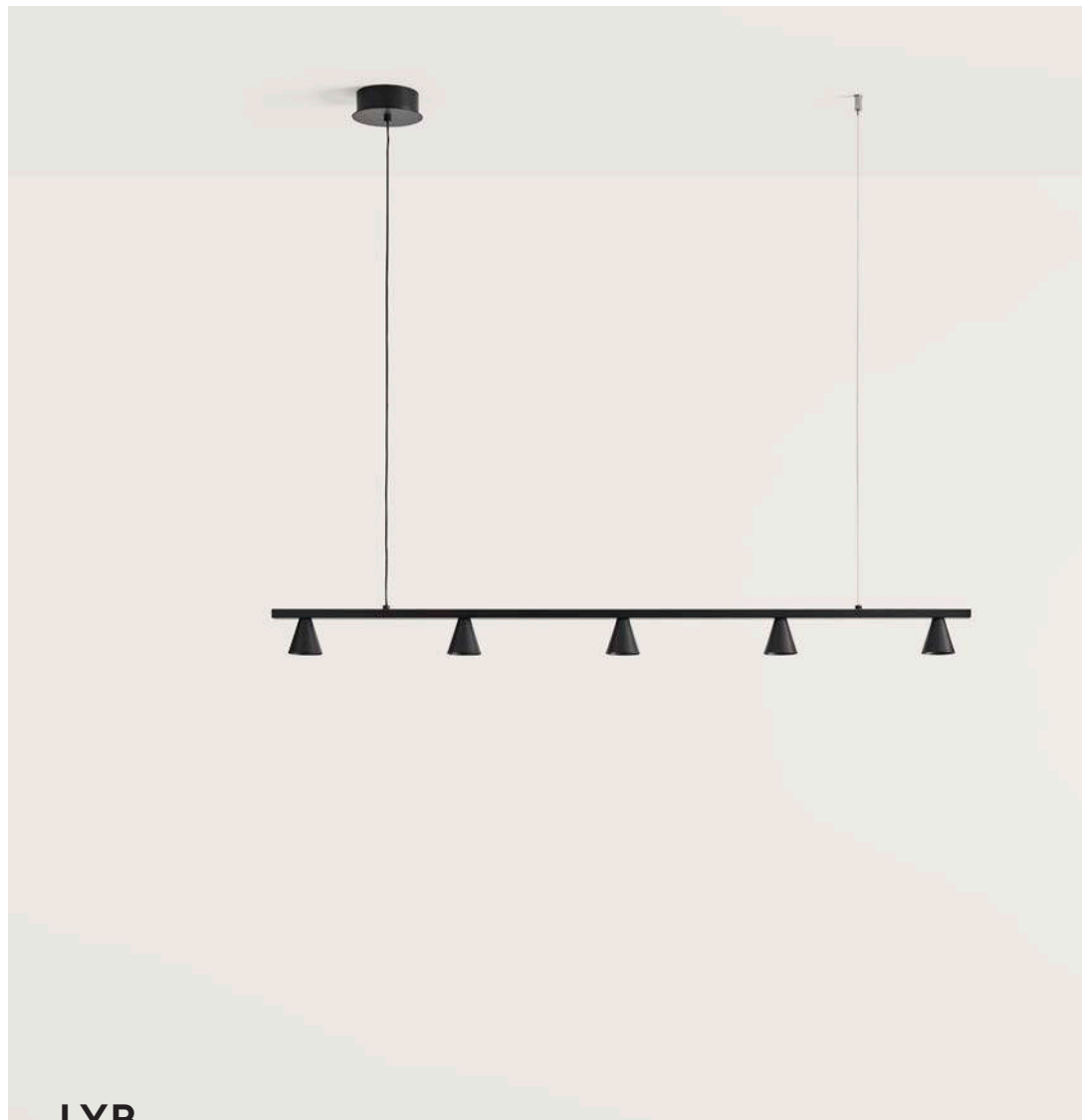

LYB

DESIGNED BY PEPE FORNAS, 2019 · C1274

ES

ACABADOS
Metal:
Negro Mate
Oro Mate

MATERIALES
Acero

ESPECIFICACIONES (UE)
5 x 5W Led integrado
3000K
36-50 V, 50/60 Hz
IP20, Clase I



CLASIFICACIÓN ENERGÉTICA
A ++

EN

FINISHES
Metal:
Matt Black
Matt Brass

MATERIALS
Steel

SPECIFICATIONS (UE)
5 x 5W Integrated Led
3000K
36-50 V, 50/60 Hz
IP20, Class I



ENERGY LABEL
A ++

TEC

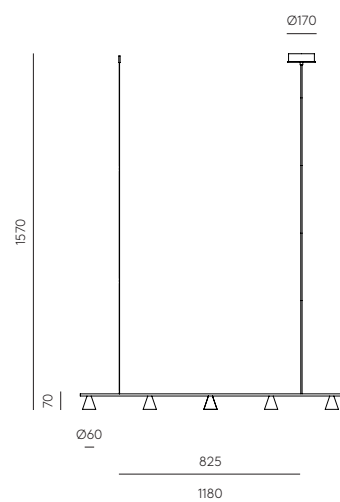

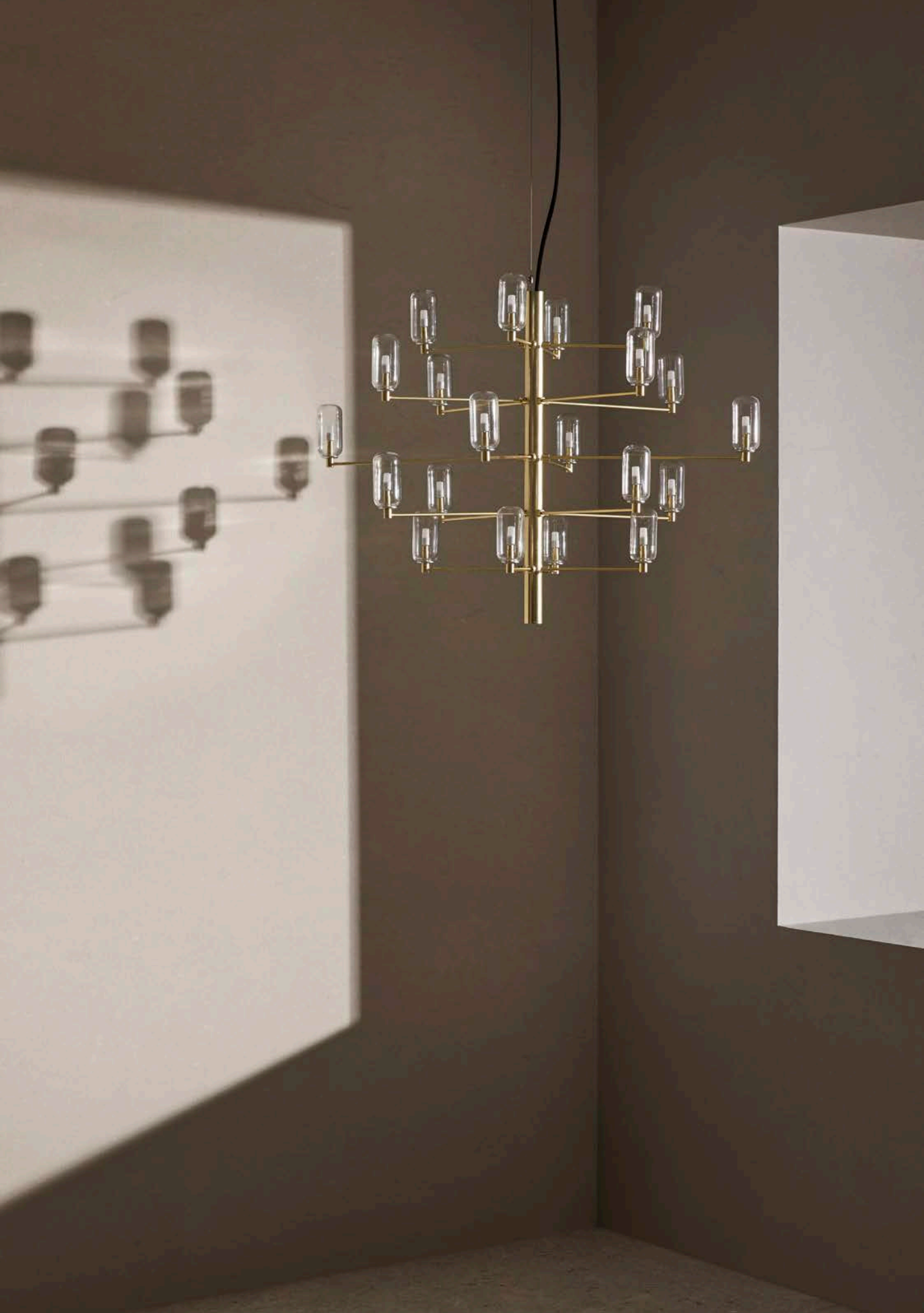

GAND

DESIGNED BY PEPE FORNAS, 2019 · C1271

ES

ACABADOS

Metal:	Cristal:
Negro Mate	Opal / Transparente
Cromo	Opal / Transparente
Oro Mate	Opal / Transparente

MATERIALES

Acero / Cristal Soplado

ESPECIFICACIONES (UE)

20 x G4 Led 1,2W - 3000K
Bombillas y tulipas incluidas
12 V, 50/60 Hz, IP20, Clase I



CLASIFICACIÓN ENERGÉTICA

A ++

EN

FINISHES

Metal:	Glass:
Matt Black	Opal / Clear
Chrome	Opal / Clear
Matt Brass	Opal / Clear

MATERIALS

Steel / Blown Glass

SPECIFICATIONS (UE)

20 x G4 Led 1,2W - 3000K
Bulbs and shades included
12 V, 50/60 Hz, IP20, Class I



ENERGY LABEL

A ++

TEC

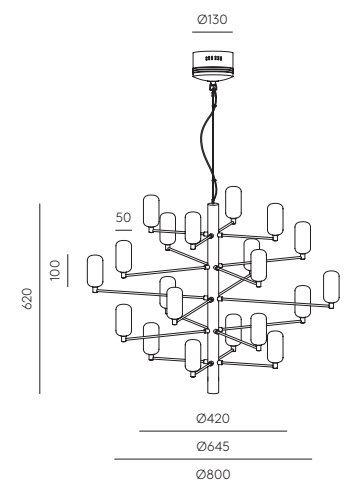

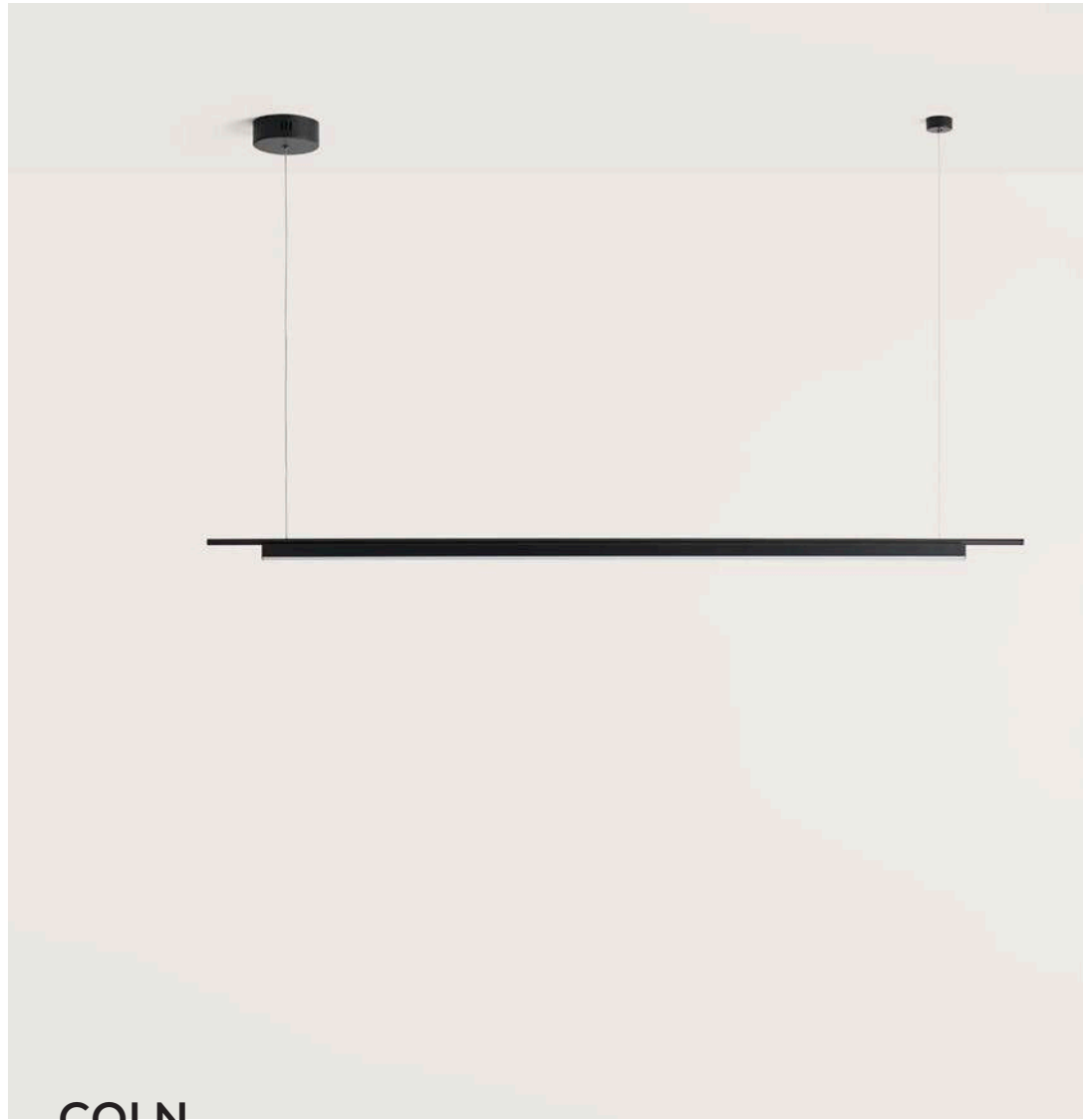

COLN

DESIGNED BY AC STUDIO, 2019 · C1267

ES

ACABADOS
Metal: Negro Mate Difusor: Blanco

MATERIALES
Acero / Acrílico

ESPECIFICACIONES (UE)
Tira LED 15W - 3000K
24 V, 50/60 Hz, IP20, Clase I



CLASIFICACIÓN ENERGÉTICA
A ++

CONSULTAR OPCIONES DE REGULACIÓN EN TARIFA

EN

FINISHES
Metal: Matt Black Diffuser: White

MATERIALS
Steel / Acrylic

SPECIFICATIONS (UE)
LED Strip 15W - 3000K
24 V, 50/60 Hz, IP20, Class I



ENERGY LABEL
A ++

ASK US FOR DIMMER OPTIONS PRICE LIST

TEC

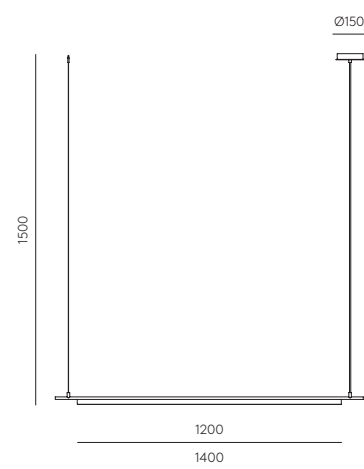

CLIP

DESIGNED BY PEPE FORNAS, 2018 · C1265

ES

ACABADOS
Metal: Negro Mate Mármol: Blanco Tulipa: Fumé
Oro Envejecido Verde Fumé
Níquel Negro Fumé

MATERIALES
Acero / Mármol / Vidrio Soplado

ESPECIFICACIONES (UE)
Bombilla 2 x G9 Led (Incluida)
2 x 5W - 3000K
220-240 V, 50/60 Hz
IP20, Clase I



CLASIFICACIÓN ENERGÉTICA
A ++

BOMBILLAS RECOMENDADAS
B005/5W

EN

FINISHES
Metal: Matt Black Marble: White Shade: Smoked
Aged Gold Green Smoked
Satin Nickel Black Smoked

MATERIALS
Steel / Marble / Blown Glass

SPECIFICATIONS (UE)
Bulb 2 x G9 Led (Included)
2 x 5W - 3000K
220-240 V, 50/60 Hz
IP20, Class I



ENERGY LABEL
A ++

RECOMMENDED BULBS
B005/5W

TEC

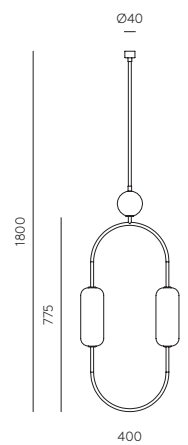



ALMON

DESIGNED BY PEPE FORNAS, 2018 · C1264

ES

ACABADOS

Metal: Negro Mate
Oro Mate (detalles)
Piel Marrón

Cristal (Incluido):
Opal

MATERIALES

Acero / Vidrio Soplado / Cuero

ESPECIFICACIONES (UE)

Bombilla G9 Led (Incluida)
5W - 2700K
220-240 V, 50/60 Hz
IP20, Clase I



CLASIFICACIÓN ENERGÉTICA

A ++

BOMBILLAS RECOMENDADAS
B005/5W

EN

FINISHES

Metal: Matt Black
Matt Brass (details)
Brown Leather

Shade (Included):
Opal

MATERIALS

Steel / Blown Glass / Leather

SPECIFICATIONS (UE)

Bulb G9 Led (Included)
5W - 2700K
220-240 V, 50/60 Hz
IP20, Class I



ENERGY LABEL

A ++

RECOMMENDED BULBS
B005/5W

TEC

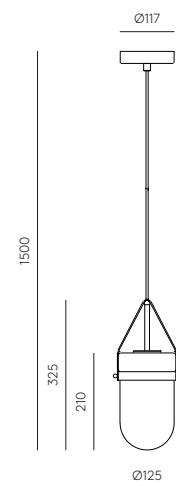

ALMON

DESIGNED BY PEPE FORNAS, 2018 · C1264/6

ES

ACABADOS

Metal: Negro Mate
Oro Mate (detalles)
Piel Marrón

Cristal (Incluido):
Opal

MATERIALES

Acero / Vidrio Soplado / Cuero

ESPECIFICACIONES (UE)

Bombilla G9 Led (Incluida)
6 x 5W - 2700K
220-240 V, 50/60 Hz
IP20, Clase I



CLASIFICACIÓN ENERGÉTICA

A ++

BOMBILLAS RECOMENDADAS
B005/5W

EN

FINISHES

Metal: Matt Black
Matt Brass (details)
Brown Leather

Shade (Included):
Opal

MATERIALS

Steel / Blown Glass / Leather

SPECIFICATIONS (UE)

Bulb G9 Led (Included)
6 x 5W - 2700K
220-240 V, 50/60 Hz
IP20, Class I



ENERGY LABEL

A ++

RECOMMENDED BULBS
B005/5W

TEC

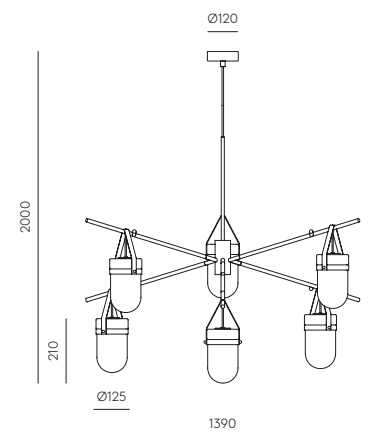

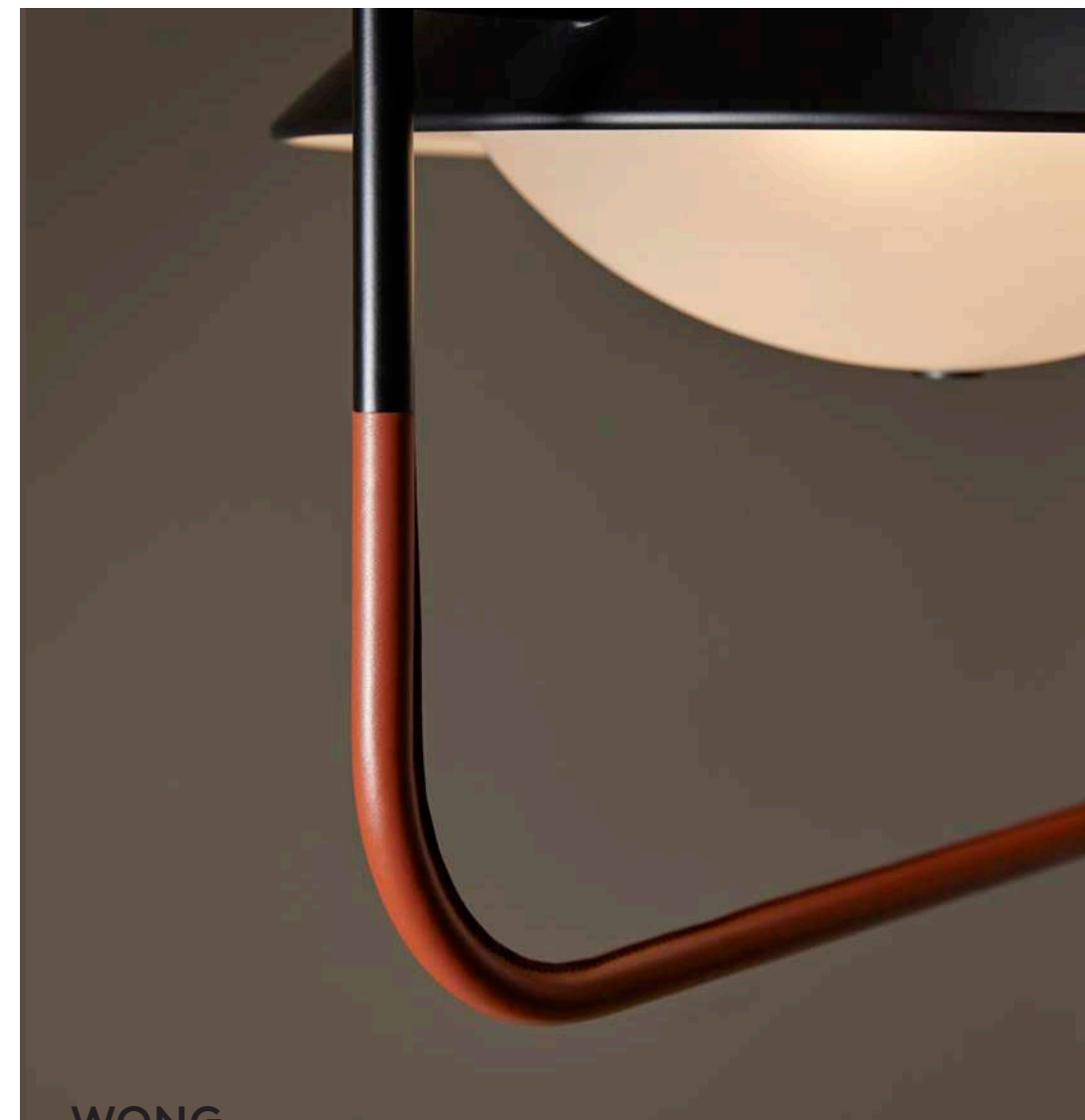

WONG

DESIGNED BY PEPE FORNAS, 2018 · C1263

ES

ACABADOS

Metal: Negro Mate
Piel Marrón

Cristal (Incluido):
Opal

MATERIALES

Acero / Vidrio / Cuero

ESPECIFICACIONES (UE)

Bombilla G9 Led (Incluida)
3 x 5W - 2700K
220-240 V, 50/60 Hz
IP20, Clase I

! IP20 CE RoHS LF A++

CLASIFICACIÓN ENERGÉTICA
A ++

BOMBILLAS RECOMENDADAS
B005/5W

EN

FINISHES

Metal: Matt Black
Brown Leather

Shade (Included):
Opal

MATERIALS

Steel / Glass / Leather

SPECIFICATIONS (UE)

Bulb G9 Led (Included)
3 x 5W - 2700K
220-240 V, 50/60 Hz
IP20, Class I

! IP20 CE RoHS LF A++

ENERGY LABEL
A ++

RECOMMENDED BULBS
B005/5W

TEC

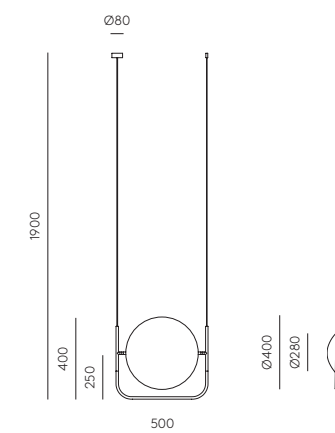



ABBACUS

DESIGNED BY PEPE FORNAS, 2018 · C1258

ES

ACABADOS

Metal:
Oro Mate
Negro Mate

Cristal:
Opal/Transparente
Opal/Transparente

MATERIALES

Acero / Vidrio Soplado

ESPECIFICACIONES (UE)

Bombilla G9 Led (Incluida)
4 x 5W - 2700K
220-240 V, 50/60 Hz
IP20, Clase I



CLASIFICACIÓN ENERGÉTICA

A ++

BOMBILLAS INCLUIDAS

B005/5W

EN

FINISHES

Metal:
Matt Brass
Matt Black

Shade:
Opal/Clear
Opal/Clear

MATERIALS

Steel / Iown Glass

SPECIFICATIONS (UE)

Bulb G9 Led (Included)
4 x 5W - 2700K
220-240 V, 50/60 Hz
IP20, Class I



ENERGY LABEL

A ++

BULBS INCLUDED

B005/5W

TEC

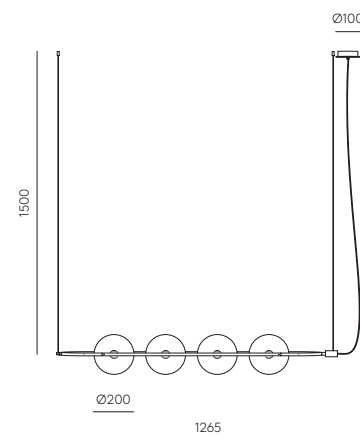

ABBACUS

DESIGNED BY PEPE FORNAS, 2018 · C1258/1

ES

ACABADOS

Metal:
Negro Mate
Oro Mate

MATERIALES

Acero / Vidrio Soplado

ESPECIFICACIONES (UE)

Bombilla G9 Led (Incluida)
5W - 2700K
220-240 V, 50/60 Hz
IP20, Clase I



CLASIFICACIÓN ENERGÉTICA

A ++

BOMBILLAS RECOMENDADAS

B005/5W

EN

FINISHES

Metal:
Matt Black
Matt Brass

MATERIALS

Steel / Blown Glass

SPECIFICATIONS (UE)

Bulb G9 Led (Included)
5W - 2700K
220-240 V, 50/60 Hz
IP20, Class I



ENERGY LABEL

A ++

RECOMMENDED BULBS

B005/5W

TEC

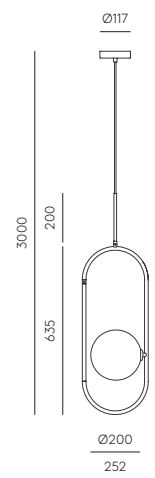

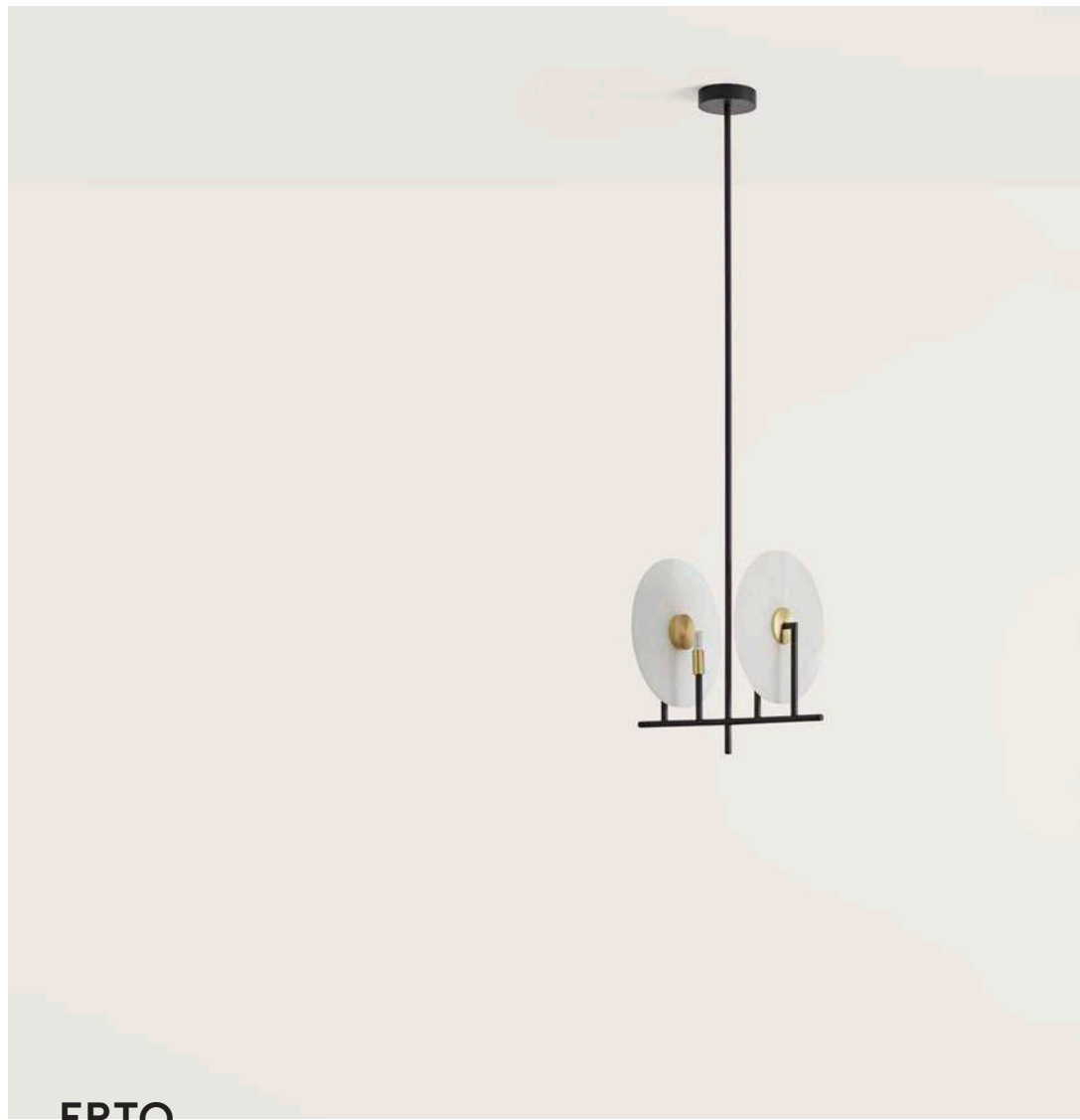

ERTO

DESIGNED BY PEPE FORNAS, 2020 · C1257/2

ES

ACABADOS

Metal:
Negro Mate
Oro Mate (detalles)

MATERIALES

Acero

ESPECIFICACIONES (UE)

2 x G9 LED 5W 3000K (Incluidas)
220-240 V, 50/60 Hz

! IP20 CE RoHS V A++

CLASIFICACIÓN ENERGÉTICA

A ++

BOMBILLAS RECOMENDADAS

B005/5W

ACCESORIOS COMPATIBLES (INCLUIDOS)

Alabastro - 1096/25
Cristal - 1223
Cerámica - 1097/20
Metal - 1038/25
Metal rayado - 1089/25

EN

FINISHES

Metal:
Matt black
Matt brass - details

MATERIALS

Steel

SPECIFICATIONS (UE)

2 x G9 LED 5W 3000K (Included)
220-240 V, 50/60 Hz

! IP20 CE RoHS V A++

ENERGY LABEL

A ++

RECOMMENDED BULBS

B005/5W

COMPATIBLE ACCESSORIES (INCLUDED)

Alabaster - 1096/25
Glass - 1223
Ceramic - 1097/20
Metal - 1038/25
Stripped metal - 1089/25

TEC

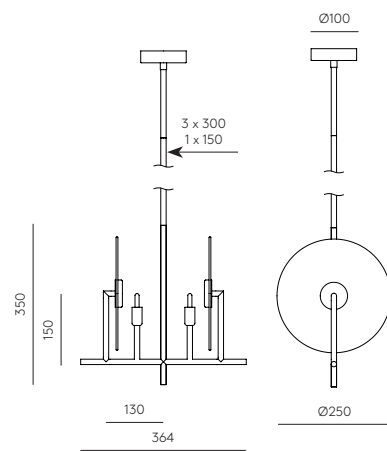

ERTO

DESIGNED BY PEPE FORNAS, 2020 · C1257/5

ES

ACABADOS

Metal:
Negro Mate
Oro Mate (detalles)

MATERIALES

Acero

ESPECIFICACIONES (UE)

2 x G9 LED 5W 3000K (Incluidas)
220-240 V, 50/60 Hz

! IP20 CE RoHS V A++

CLASIFICACIÓN ENERGÉTICA

A ++

BOMBILLAS RECOMENDADAS

B005/5W

ACCESORIOS COMPATIBLES (INCLUIDOS)

Alabastro - 1096/25
Cristal - 1223
Cerámica - 1097/20
Metal - 1038/25
Metal rayado - 1089/25

EN

FINISHES

Metal:
Matt black
Matt brass (details)

MATERIALS

Steel

SPECIFICATIONS (UE)

2 x G9 LED 5W 3000K (Included)
220-240 V, 50/60 Hz

! IP20 CE RoHS V A++

ENERGY LABEL

A ++

RECOMMENDED BULBS

B005/5W

COMPATIBLE ACCESSORIES (INCLUDED)

Alabaster - 1096/25
Glass - 1223
Ceramic - 1097/20
Metal - 1038/25
Stripped metal - 1089/25

TEC

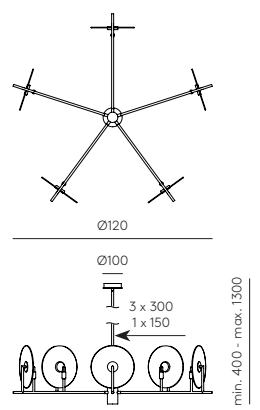





TINNO

DESIGNED BY AC STUDIO, 2019 · C1253

ES

ACABADOS
Metal: Negro Mate
Cinta Textil: Marrón

MATERIALES
Acero / Cinta Textil

ESPECIFICACIONES (UE)
Tira Led integrado
30W - 3000K
24 V, 50/60 Hz, IP20, Clase I



CLASIFICACIÓN ENERGÉTICA
A ++

CONSULTAR OPCIONES DE REGULACIÓN
EN TARIFA

EN

FINISHES
Metal: Matt Black
Textil Ribbon: Brown

MATERIALS
Steel / Textil Ribbon

SPECIFICATIONS (UE)
Integrated LED Strip
30W - 3000K
24 V, 50/60 Hz, IP20, Class I



ENERGY LABEL
A ++

ASK US FOR DIMMER OPTIONS
PRICE LIST

TEC

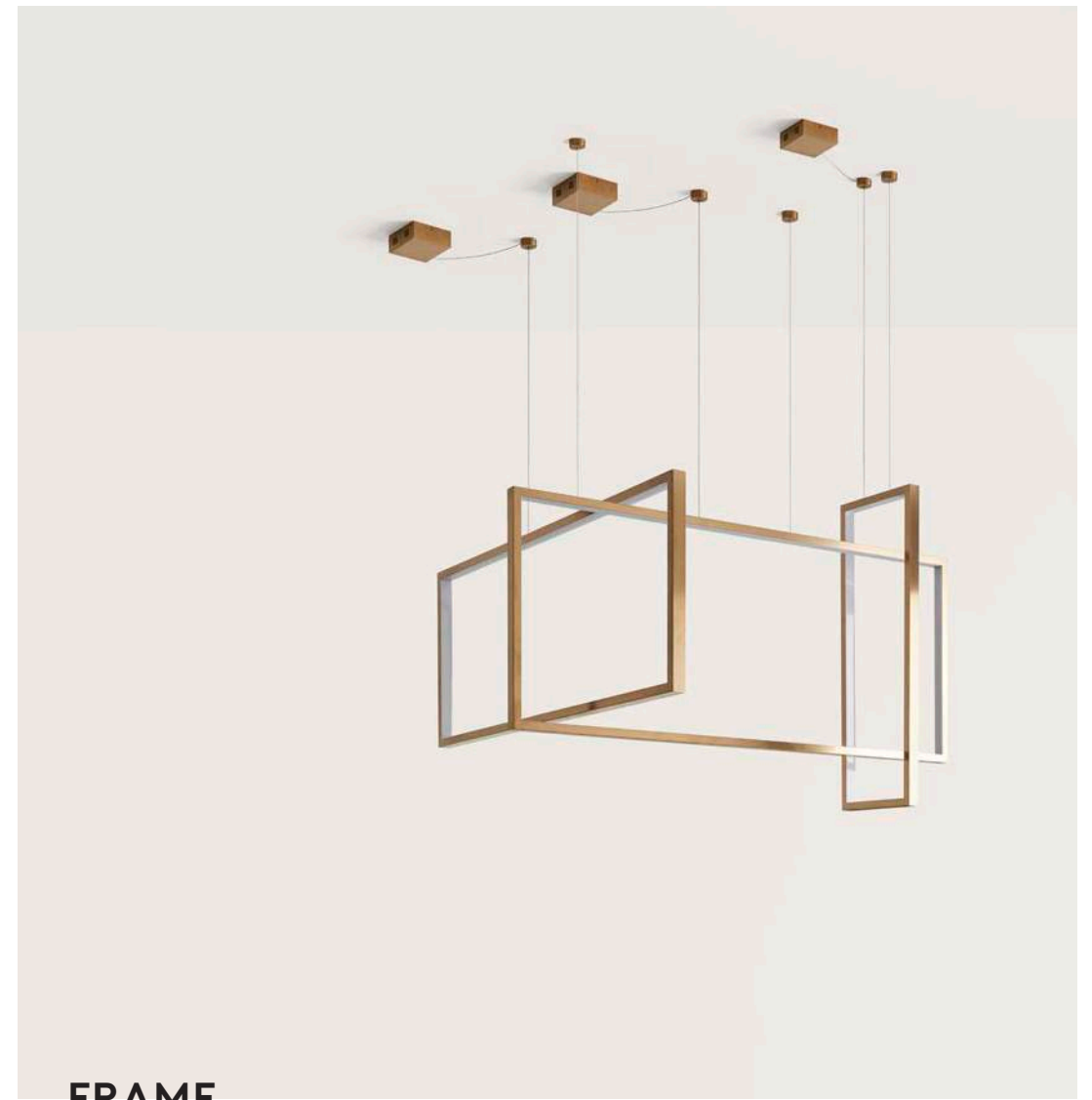
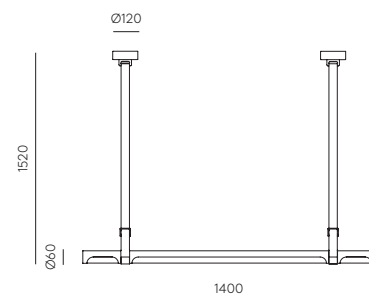

FRAME

DESIGNED BY AC STUDIO, 2018 · C1246

ES

ACABADOS
Metal: Bronce
Negro Mate

MATERIALES
Acero

ESPECIFICACIONES (UE)
24 V, 50/60 Hz, IP20, Clase I



CLASIFICACIÓN ENERGÉTICA
A ++

TAMAÑOS
1400 x 600 - 36W Led 3000K
1200 x 500 - 30W Led 3000K
900 x 300 - 22W Led 3000K

SE VENDE POR SEPARADO

CONSULTAR OPCIONES DE REGULACIÓN
EN TARIFA

EN

FINISHES
Metal: Bronze
Matt Black

MATERIALS
Steel

SPECIFICATIONS (UE)
24 V, 50/60 Hz, IP20, Class I



ENERGY LABEL
A ++

SIZES
1400 x 600 - 36W Led 3000K
1200 x 500 - 30W Led 3000K
900 x 300 - 22W Led 3000K

SOLD INDIVIDUALLY

ASK US FOR DIMMER OPTIONS
PRICE LIST

TEC

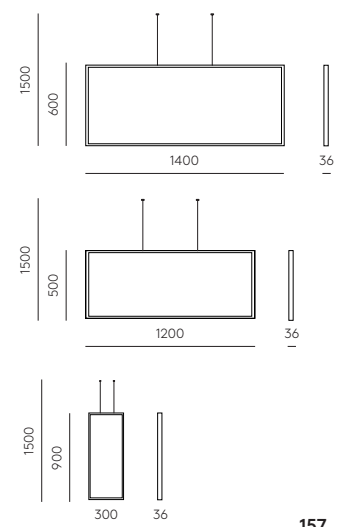



FICUS

DESIGNED BY PEPE FORNAS, 2018 · C1243

ES

ACABADOS

Metal:
Negro Mate Oro Mate
Oro Mate Oro Mate

Tulipa:
Oro Mate
Oro Mate

MATERIALES

Acero

ESPECIFICACIONES (UE)

G9 (Incluida)
2 x 5W - 2700K
220-240 V, 50/60 Hz
IP20, Clase I



CLASIFICACIÓN ENERGÉTICA

A ++

BOMBILLAS INCLUIDAS

B005/5W

EN

FINISHES

Metal:
Matt Black Matt Brass
Matt Brass Matt Brass

Shade:
Matt Brass
Matt Brass

MATERIALS

Steel

SPECIFICATIONS (UE)

G9 (Included)
2 x 5W - 2700K
220-240 V, 50/60 Hz
IP20, Class I



ENERGY LABEL

A ++

BULBS INCLUDED

B005/5W

TEC

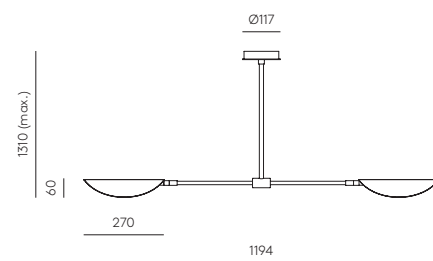

OHLALA

DESIGNED BY AC STUDIO, 2018 · C1242

ES

ACABADOS

Metal:
Negro Mate
Blanco Mate

Portalámparas:
Oro
Oro

MATERIALES

Acero

ESPECIFICACIONES (UE)

4 x E27 Max. 60W (No incluida)
220-240 V, 50/60 Hz
IP20, Clase I



CLASIFICACIÓN ENERGÉTICA

A ++

ACCESORIOS

Accesorio imagen 1096/20
Bombilla imagen B038/ORO
(No incluidos)
Accesorios compatibles máx 25cm.
Más opciones en pág. 362

EN

FINISHES

Metal:
Matt Black
Matt White

Lampholders:
Matt Brass
Matt Brass

MATERIALS

Steel

SPECIFICATIONS (UE)

4 x E27 Max. 60W (Not included)
220-240 V, 50/60 Hz
IP20, Class I



ENERGY LABEL

A ++

ACCESSORIES

Image reference accessory 1096/20
Image reference bulb B038/GOLD
(Not included)
Compatible accessories 25cm max.
More options in page 362

TEC

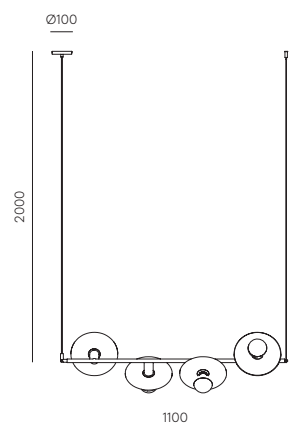





CRANE

DESIGNED BY JF SEVILLA, 2017 · C1241

ES

ACABADOS

Metal: Negro
Cristal: Opal
 Oro Mate (Detalles)

MATERIALES

Acero / Vidrio Soplado

ESPECIFICACIONES (UE)

E27 Max. 60W (No incluida)
 G4 2 x 3W - 2700K (Incluidas)
 220-240 V, 50/60 Hz
 IP20, Clase I



CLASIFICACIÓN ENERGÉTICA
 A ++

BOMBILLA E27 RECOMENDADA
 B211 (7, 9, 11W)

EN

FINISHES

Metal: Matt Black
Glass: Opal
 Matt Brass (Details)

MATERIALS

Steel / Blown Glass

SPECIFICATIONS (UE)

E27 Max. 60W (Not included)
 G4 2 x 3W - 2700K (Included)
 220-240 V, 50/60 Hz
 IP20, Class I



ENERGY LABEL
 A ++

RECOMMENDED E27 BULB
 B211 (7, 9, 11W)

TEC

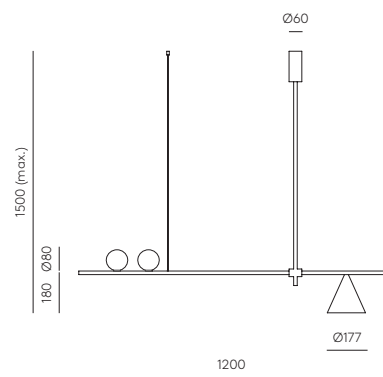



LUCA +

DESIGNED BY AC STUDIO, 2017 · C1239/3

ES

ACABADOS
Metal:
Negro

MATERIALES
Acero

ESPECIFICACIONES (UE)
3 x E27 Max. 60W
(No incluida)
220-240 V, 50/60 Hz
IP20, Clase I



CLASIFICACIÓN ENERGÉTICA
A ++

BOMBILLAS RECOMENDADAS
B211 (7, 9, 11W)

EN

FINISHES
Metal:
Black

MATERIALS
Steel

SPECIFICATIONS (UE)
3 x E27 Max. 60W
(Not included)
220-240 V, 50/60 Hz
IP20, Class I



ENERGY LABEL
A ++

RECOMMENDED BULBS
B211 (7, 9, 11W)

TEC

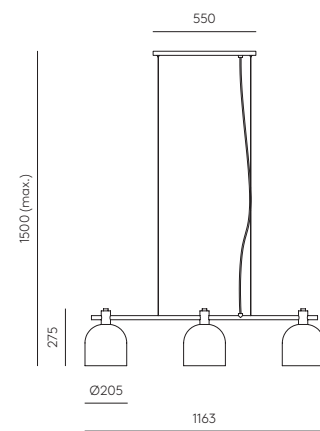

LUCA

DESIGNED BY AC STUDIO, 2017 · C1238

ES

ACABADOS
Metal: Negro Difusor: Transparente

MATERIALES
Acero / Acrílico

ESPECIFICACIONES (UE)
E27 Max. 60W
(No incluida)
220-240 V, 50/60 Hz
IP20, Clase I



CLASIFICACIÓN ENERGÉTICA
A ++

BOMBILLAS RECOMENDADAS
B211 (7, 9, 11W)

EN

FINISHES
Metal: Black Diffuser: Clear

MATERIALS
Steel / Acrylic

SPECIFICATIONS (UE)
3 x E27 Max. 60W
(Not included)
220-240 V, 50/60 Hz
IP20, Class I



ENERGY LABEL
A ++

RECOMMENDED BULBS
B211 (7, 9, 11W)

TEC

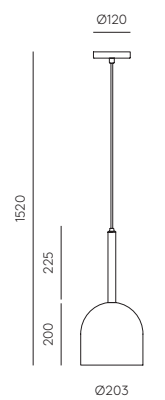



LOTA

DESIGNED BY PEPE FORNAS, 2021 - C1235

ES

ACABADOS
Metal: Negro Mate
Tulipa (Incluida): Transparente

MATERIALES
 Acero / Vidrio Soplado

ESPECIFICACIONES (UE)
 Placa LED integrada Regulable
 9W 3000K
 24V, 50/60 Hz
 IP20, Clase I



CLASIFICACIÓN ENERGÉTICA
 A ++

EN

FINISHES
Metal: Matt Black
Glass Shade (Included): Clear

MATERIALS
 Steel / Blown Glass

SPECIFICATIONS (UE)
 Integrated Dimmable LED
 9W 3000K
 24V, 50/60 Hz
 IP20, Clase I



ENERGY LABEL
 A ++

TEC

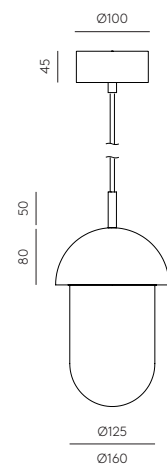



LITA

DESIGNED BY PEPE FORNAS, 2020 · C1230/4

ES

ACABADOS

Metal: Negro Mate
Madera: Negro Mate Nogal

MATERIALES

Acero / Madera nogal

ESPECIFICACIONES (UE)

4 x COB LED integrado
3W 3000K (Incluida)
12V / 220-240 V, 50/60 Hz

IP20

CLASIFICACIÓN ENERGÉTICA

A ++

EN

FINISHES

Metal: Matt Black
Wood: Matt black Walnut

MATERIALS

Steel / Walnut Wood

SPECIFICATIONS (UE)

4 x LED COB integrated
3W 3000K (Included)
12V / 220-240 V, 50/60 Hz

IP20

ENERGY LABEL

A ++

TEC

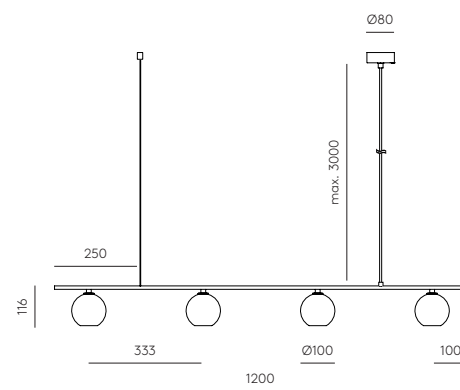

LITA

DESIGNED BY PEPE FORNAS, 2020 · C1230

ES

ACABADOS

Metal: Negro Mate
Madera: Negro Mate Nogal

MATERIALES

Acero / Madera nogal

ESPECIFICACIONES (UE)

COB LED integrado
3W 3000K (Incluida)
12V / 220-240 V, 50/60 Hz

IP20

CLASIFICACIÓN ENERGÉTICA

A ++

EN

FINISHES

Metal: Matt Black
Wood: Matt black Walnut

MATERIALS

Steel / Walnut Wood

SPECIFICATIONS (UE)

LED COB integrated
3W 3000K (Included)
12V / 220-240 V, 50/60 Hz

IP20

ENERGY LABEL

A ++

TEC

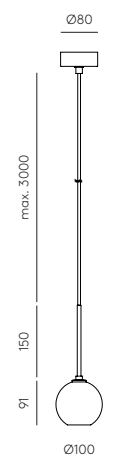





NERA

DESIGNED BY PEPE FORNAS, 2020 · C1229

ES

ACABADOS
Metal:
Negro Mate

MATERIALES
Acero / Acrílico





ESPECIFICACIONES (UE)
COB LED integrado 8W 3000K
(Incluida)
12V / 220-240 V, 50/60 Hz
IP20     

CLASIFICACIÓN ENERGÉTICA
A ++

EN

FINISHES
Metal:
Matt Black

MATERIALS
Steel / Acrylic

SPECIFICATIONS (UE)
LED COB integrated 8W 3000K
(Included)
12V / 220-240 V, 50/60 Hz
IP20     

ENERGY LABEL
A ++

TEC

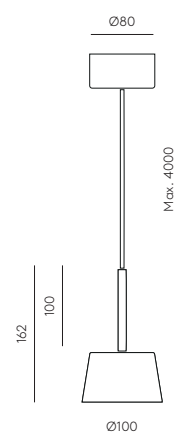



DORA

DESIGNED BY JANA CHANG, 2016 · C1228

ES

ACABADOS
Metal: Oro Brillo
Florón / Cable: Negro Mate

MATERIALES
Acero / Cristal Óptico





ESPECIFICACIONES (UE)
Led integrado
6,5W - 3000K
12 V, 50/60 Hz
IP20, Clase I
     

CLASIFICACIÓN ENERGÉTICA
A ++

EN

FINISHES
Metal: Shiny Gold
Canopy / Cable: Matt Black

MATERIALS
Steel / Optic Glass

SPECIFICATIONS (UE)
Integrated Led
6,5W - 3000K
12 V, 50/60 Hz
IP20, Class I
     

ENERGY LABEL
A ++

TEC

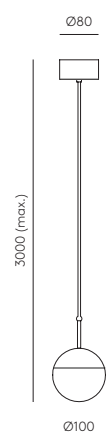



ALOA - L

DESIGNED BY FORNASEVI, 2016 · C1227/4

ES

ACABADOS

Metal: Negro
Difusor: Oro Brillo

MATERIALES
Acero

ESPECIFICACIONES (UE)
4 x E27 Max. 60W
(No incluida)
220-240 V, 50/60 Hz
IP20, Clase I



CLASIFICACIÓN ENERGÉTICA
A ++

BOMBILLA IMAGEN
B038/ORO

EN

FINISHES

Metal: Black
Diffuser: Shiny Gold

MATERIALS
Steel

SPECIFICATIONS (UE)
4 x E27 Max. 60W
(Not included)
220-240 V, 50/60 Hz
IP20, Class I



ENERGY LABEL
A ++

BULB IMAGE
B038/ORO

TEC

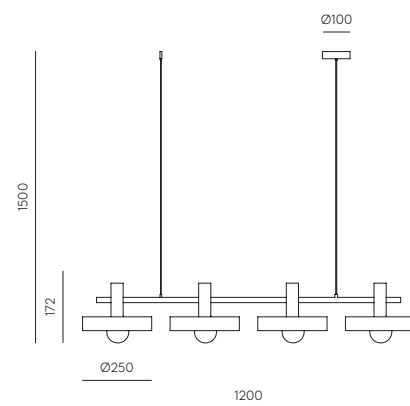

ALOA

DESIGNED BY FORNASEVI, 2016 · C1227

ES

ACABADOS

Metal: Negro
Difusor: Oro Brillo

MATERIALES
Acero

ESPECIFICACIONES (UE)
E27 Max. 60W
(No incluida)
220-240 V, 50/60 Hz
IP20, Clase I



CLASIFICACIÓN ENERGÉTICA
A ++

BOMBILLA IMAGEN
B038/ORO

EN

FINISHES

Metal: Black
Diffuser: Shiny Gold

MATERIALS
Steel

SPECIFICATIONS (UE)
E27 Max. 60W
(Not included)
220-240 V, 50/60 Hz
IP20, Class I



ENERGY LABEL
A ++

BULB IMAGE
B038/ORO

TEC

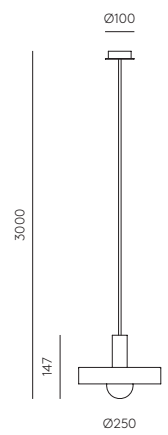

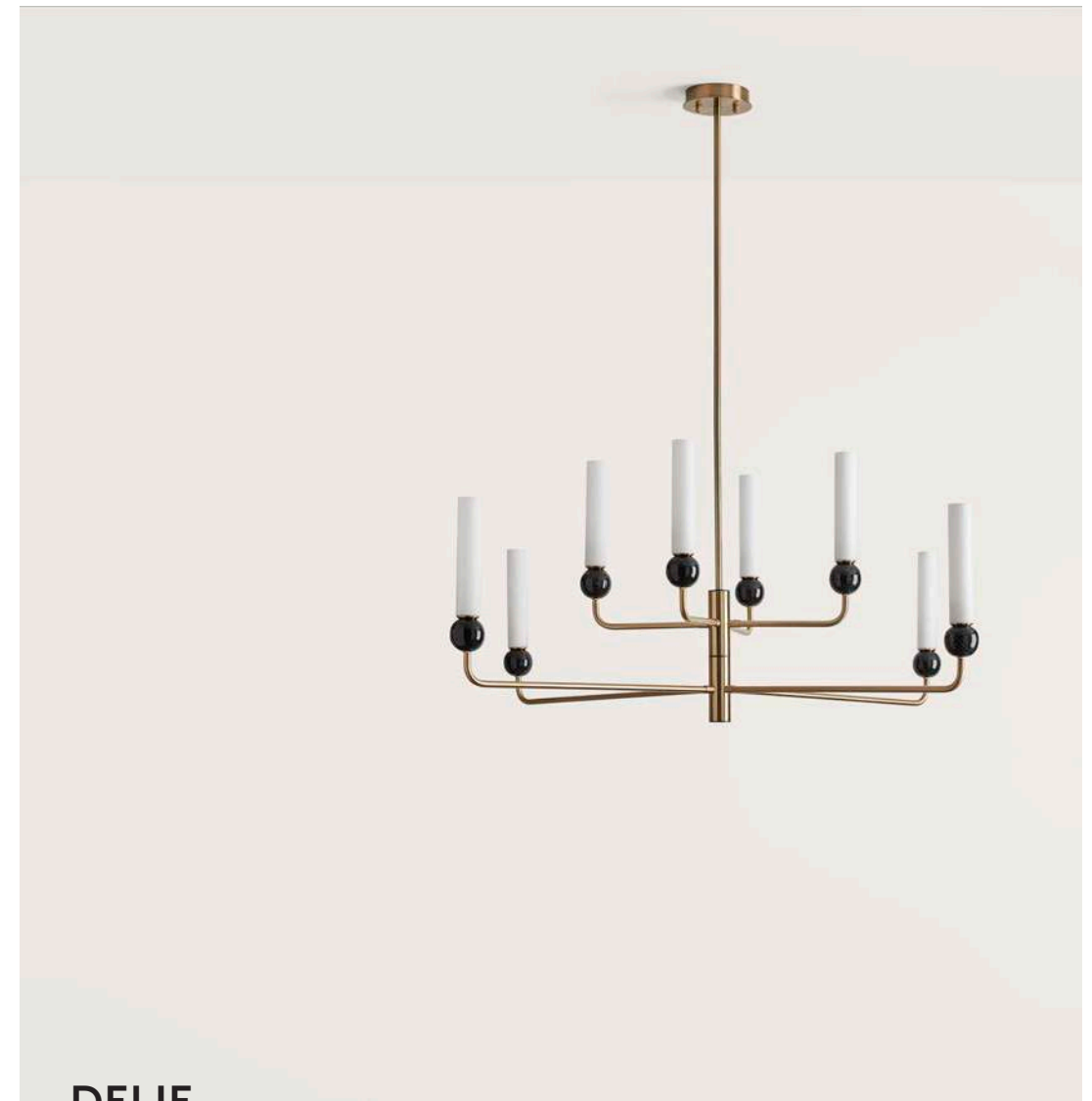

DELIE

DESIGNED BY JF SEVILLA, 2020 · C1224/8

ES

ACABADOS

Metal:
Negro Mate
Oro Envejecido

Mármol:
Blanco
Negro

Cristal:
Opal
Opal

MATERIALES

Acero / Vidrio Soplado / Mármol

ESPECIFICACIONES (UE)

Bombillas G9 LED (Incluidas)
8 x 5W 3000K
220-240 V, 50/60 Hz
IP20, Clase I

IP20 CE RoHS LF A++

CLASIFICACIÓN ENERGÉTICA

A ++

BOMBILLA RECOMENDADA

B005 / 5W

EN

FINISHES

Metal:
Matt Black
Aged Gold

Marble:
White
Black

Glass:
Opal
Opal

MATERIALS

Steel / Blown Glass / Marble

SPECIFICATIONS (UE)

G9 LED Bulbs (Included)
8 x 5W 3000K
220-240 V, 50/60 Hz
IP20, Class I

IP20 CE RoHS LF A++

ENERGY LABEL

A ++

RECOMMENDED BULB

B005 / 5W

TEC

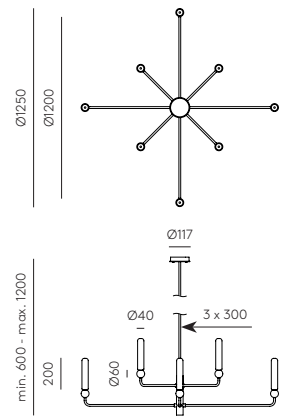



DELIE

DESIGNED BY JF SEVILLA, 2020 · C1224

ES

ACABADOS

Metal: Negro Mate
Oro envejecido

Mármol: Blanco
Negro

Tulipas: Opales
Opales

MATERIALES

Metal / Mármol / Vidrio

ESPECIFICACIONES (UE)

G9 LED 5W 3000K (Incluida)
220-240 V, 50/60 Hz

IP20     

CLASIFICACIÓN ENERGÉTICA

A ++

BOMBILLA RECOMENDADAS

B005/5W

EN

FINISHES

Metal: Matt Black
Old Gold

Marble: White
Black

Shades: Opal
Opal

MATERIALS

Metal / Marble / Glass

SPECIFICATIONS (UE)

G9 LED 5W 3000K (Included)
220-240 V, 50/60 Hz

IP20     

ENERGY LABEL

A ++

RECOMMENDED BULB

B005/5W

TEC

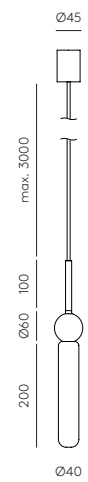

FEST

DESIGNED BY JF SEVILLA, 2016 · C1223

ES

ACABADOS

Metal: Negro Mate

Cable: Negro
Cobre

MATERIALES

Acero / Vidrio / Cable Textil

ESPECIFICACIONES (UE)

6 x E27 Max. 60W (No incluida)
220-240 V, 50/60 Hz, IP20, Clase I

↓ IP20      

CLASIFICACIÓN ENERGÉTICA

A ++

COLORES CRISTAL

Turquesa, ámbar, rosa,
azul oscuro y marrón.
Cristales incluidos.
Más opciones en pág.362.

BOMBILLA IMAGEN

B038/ORO

EN

FINISHES

Metal: Matt Black

Cable: Black
Copper

MATERIALS

Steel / Glass / Fabric Cable

SPECIFICATIONS (UE)

6 x E27 Max. 60W (Not included)
220-240 V, 50/60 Hz, IP20, Class I

↓ IP20     

ENERGY LABEL

A ++

COLOR GLASS

Turquoise, amber, pink,
dark blue & brown.
Glasses included.
More options accessory page 362.

BULB IMAGE

B038/GOLD

TEC

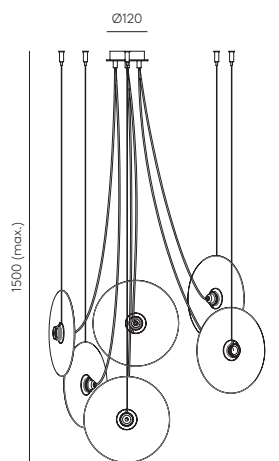



YOYO

DESIGNED BY PEPE FORNAS, 2016 · C1222

ES

ACABADOS

Metal:
 Negro Mate
 Negro Mate
 Negro Mate
 Negro Mate

Difusor:
 Oro Brillo
 Cromo
 Negro Mate
 Blanco Mate

MATERIALES

Acero

ESPECIFICACIONES (UE)

Bombillas G9 Led (Incluida)
 3 x 3W - 2700K
 220-240 V, 50/60 Hz
 IP20, Clase I



CLASIFICACIÓN ENERGÉTICA

A ++

BOMBILLAS RECOMENDADAS

B005

EN

FINISHES

Metal:
 Matt Black
 Matt Black
 Matt Black
 Matt Black

Diffuser:
 Shiny Gold
 Chrome
 Matt Black
 Matt White

MATERIALES

Steel

SPECIFICATIONS (UE)

G9 Led Bulbs (Included)
 3 x 3W - 2700K
 220-240 V, 50/60 Hz
 IP20, Class I



ENERGY LABEL

A ++

RECOMMENDED BULBS

B005

TEC

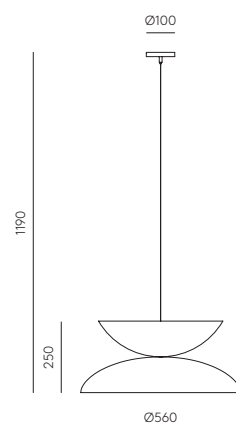

HELMET

DESIGNED BY PEPE FORNAS, 2016 · C1221

ES

ACABADOS

Metal:
 Oro Brillo
 Oro Mate
 Negro Mate
 Cromo

MATERIALES

Acero / Vidrio Soplado

ESPECIFICACIONES (UE)

E27 - B033/COB incluida (opal)
 3W - 3000K
 220-240 V, 50/60 Hz, IP20,
 Clase I



CLASIFICACIÓN ENERGÉTICA

A ++

MODIFICACIONES POSIBLES

B034/COB - Transparente

EN

FINISHES

Metal:
 Shiny Gold
 Matt Brass
 Matt Black
 Chrome

MATERIALS

Steel / Blown Glass

SPECIFICATIONS (UE)

E27 - B033/COB included (opal)
 3W - 3000K
 220-240 V, 50/60 Hz, IP20,
 Class I



ENERGY LABEL

A ++

POSSIBLE MODIFICATIONS

B034/COB - Clear

TEC

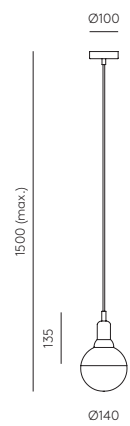



LIND

DESIGNED BY AGUSTÍN GASCÓN, 2020 · C1220

ES

ACABADOS

Metal: Oro Mate
Tulipa: Alabastro

MATERIALES

Acero / Alabastro

ESPECIFICACIONES (UE)

Bombilla G9 Led (Incluida)
5W - 2700K
220-240 V, 50/60 Hz
IP20, Clase I



CLASIFICACIÓN ENERGÉTICA

A ++

BOMBILLA RECOMENDADA

B005/5W

EN

FINISHES

Metal: Matt Brass
Shade: Alabaster

MATERIALS

Steel / Alabaster

SPECIFICATIONS (UE)

Bulb G9 Led (Included)
5W - 2700K
220-240 V, 50/60 Hz
IP20, Class I



ENERGY LABEL

A ++

RECOMMENDED BULB

B005/5W

TEC

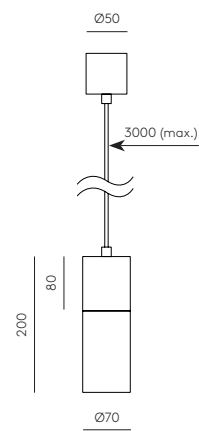

BALL

DESIGNED BY AC STUDIO, 2017 · C1215

ES

ACABADOS

Metal: Oro Mate
Cristal (Incluido): Opal/Transparente
Negro Mate: Opal/Transparente

MATERIALES

Acero / Vidrio Soplado

ESPECIFICACIONES (UE)

Bombilla G9 Led (Incluida)
5W - 2700K
220-240 V, 50/60 Hz
IP20, Clase I



CLASIFICACIÓN ENERGÉTICA

A ++

BOMBILLA INCLUIDA

B005/5W

EN

FINISHES

Metal: Matt Brass
Shade (Included): Opal/Clear
Matt Black: Opal/Clear

MATERIALS

Steel / Blown Glass

SPECIFICATIONS (UE)

Bulb G9 Led (Included)
5W - 2700K
220-240 V, 50/60 Hz
IP20, Class I



ENERGY LABEL

A ++

BULB INCLUDED

B005/5W

TEC

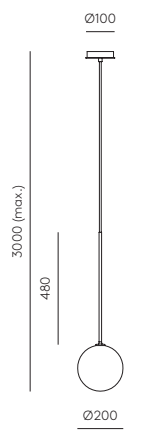



ATOM

DESIGNED BY AC STUDIO, 2016 · C1214/8

ES

ACABADOS

Metal: Oro Mate
Negro Mate

Cristal (Incluido)
Opal/Transparente
Opal/Transparente

MATERIALES

Acero / Vidrio Soplado

ESPECIFICACIONES (UE)

Bombilla G9 Led (Incluida)
8 x 5W - 2700K
220-240 V, 50/60 Hz
IP20, Clase I



CLASIFICACIÓN ENERGÉTICA

A ++

BOMBILLAS INCLUIDAS

B005/5W

EN

FINISHES

Metal: Matt Brass
Matt Black

Shade (Included)
Opal/Clear
Opal/Clear

MATERIALS

Steel / Blown Glass

SPECIFICATIONS (UE)

Bulb G9 Led (Included)
8 x 5W - 2700K
220-240 V, 50/60 Hz
IP20, Class I



ENERGY LABEL

A ++

BULBS INCLUDED

B005/5W

TEC

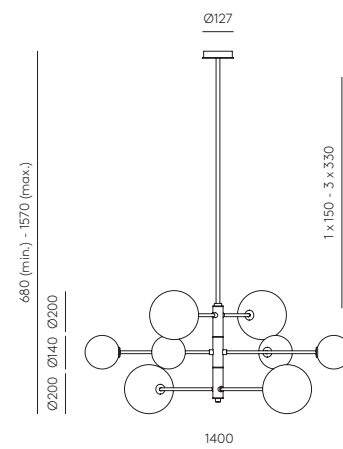



CUBE - X

DESIGNED BY AC STUDIO, 2016 · C1213

ES

ACABADOS

Metal:
Cromo
Oro Brillo

MATERIALES

Acero

ESPECIFICACIONES (UE)

Tira Led - 24 V, 50/60 Hz
IP20, Clase I



CLASIFICACIÓN ENERGÉTICA

A ++

TAMAÑOS

44 x 44 x 44 - 40W Led 3000K
60 x 40 x 35 - 45W Led 3000K
65 x 65 x 65 - 55W Led 3000K
90 x 90 x 90 - 75W Led 3000K

MODIFICACIONES POSIBLES

Posibilidad de regulación
Consultar tarifa

EN

FINISHES

Metal:
Chrome
Shinny Gold

MATERIALS

Steel

SPECIFICATIONS (UE)

Strip Led - 24 V, 50/60 Hz
IP20, Class I



ENERGY LABEL

A ++

SIZES

44 x 44 x 44 - 40W Led 3000K
60 x 40 x 35 - 45W Led 3000K
65 x 65 x 65 - 55W Led 3000K
90 x 90 x 90 - 75W Led 3000K

POSSIBLE MODIFICATIONS

Dimmable options
Check price list

TEC

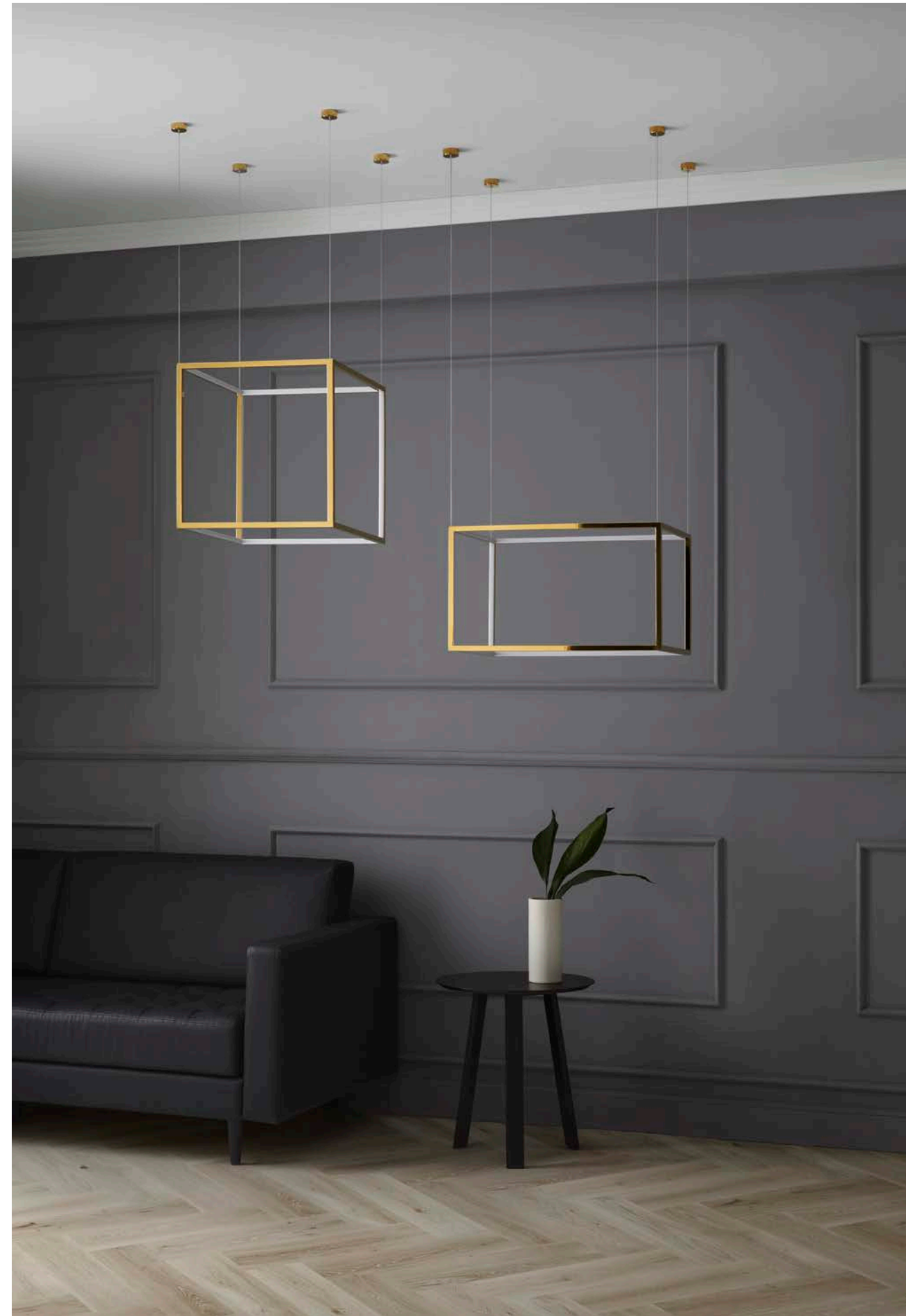
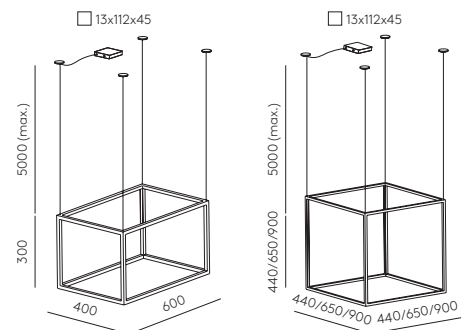



ANET

DESIGNED BY AGUSTÍN GASCÓN, 2018 · C1206

ES

ACABADOS

Metal:	Mármol:	Cristal:
Negro Mate	Blanco	Opal
Bronce	Marrón	Opal
Oro Envejecido	Verde	Opal
Níquel	Negro	Opal

MATERIALES

Acero / Mármol / Vidrio Soplado

ESPECIFICACIONES (UE)

Bombilla G9 Led (Incluida)
5W - 3000K
220-240 V, 50/60 Hz
IP20, Clase I



CLASIFICACIÓN ENERGÉTICA

A ++

BOMBILLAS INCLUIDAS

B005/5W

EN

FINISHES

Metal:	Marble:	Glass:
Matt Black	White	Opal
Bronze	Brown	Opal
Aged Gold	Green	Opal
Nickel	Black	Opal

MATERIALS

Steel / Marble / Blown Glass

SPECIFICATIONS (UE)

Bulb G9 Led (Included)
5W - 3000K
220-240 V, 50/60 Hz
IP20, Class I



ENERGY LABEL

A ++

BULBS INCLUDED

B005/5W

TEC

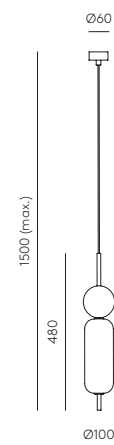

MIKA MULTI

DESIGNED BY AC STUDIO, 2016 · C1204/8

ES

ACABADOS

Metal:	Aro y Florón:
Cromo Negro	Negro
Oro	Negro
Cobre	Negro
Bronce	Negro
Madera Teka	Negro
Blanco	Negro
Cromo	Negro

MATERIALES

Acero

ESPECIFICACIONES (UE)

Led COB integrado
8 x 1W - 3000K
12 V, 50/60 Hz
IP20, Clase I



CLASIFICACIÓN ENERGÉTICA

A ++

EN

FINISHES

Metal:	Ring and Canopy:
Chrome Black	Black
Gold	Black
Copper	Black
Bronze	Black
Teka Wood	Black
White	Black
Chrome	Black

MATERIALS

Steel

SPECIFICATIONS (UE)

Integrated COB Led
8 x 1W - 3000K
12 V, 50/60 Hz
IP20, Class I



ENERGY LABEL

A ++

TEC

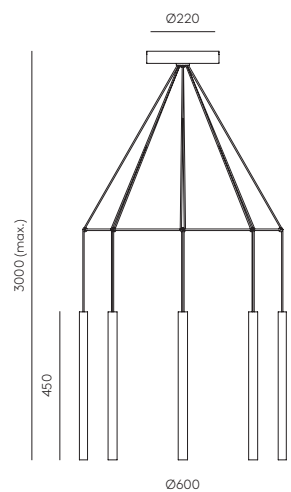



MIKA

DESIGNED BY AC STUDIO, 2016 · C1204

ES

ACABADOS

Metal:
Cromo Negro
Oro
Cobre
Bronce
Madera Teka
Blanco
Cromo

MATERIALES

Acero

ESPECIFICACIONES (UE)

LED COB integrado
1W - 3000K
12 V, 50/60 Hz
IP20, Clase I



CLASIFICACIÓN ENERGÉTICA

A ++

EN

FINISHES

Metal:
Chrome Black
Gold
Copper
Bronze
Teka Wood
White
Chrome

MATERIALS

Steel

SPECIFICATIONS (UE)

Integrated COB LED
1W - 3000K
12 V, 50/60 Hz
IP20, Class I



ENERGY LABEL

A ++

TEC



LEJO

DESIGNED BY AC STUDIO, 2020 · C1202

ES

ACABADOS

Metal:	Madera:	Difusor:
Negro Mate	Teka	Opal
Oro mate	Teka	Opal
Cromo	Teka	Opal

MATERIALES

Metal / Madera / Acrílico

ESPECIFICACIONES (UE)

COB LED integrado 5W 3000K
(Incluida)
12V / 220-240 V, 50/60 Hz



CLASIFICACIÓN ENERGÉTICA

A ++

EN

FINISHES

Metal:	Wood:	Diffuser:
Matt Black	Teak	Opal
Matt brass	Teak	Opal
Chrome	Teak	Opal

MATERIALS

Metal / Wood / Acrylic

SPECIFICATIONS (UE)

COB LED integrated 5W
3000K (Included)
12V / 220-240 V, 50/60 Hz



ENERGY LABEL

A ++

TEC

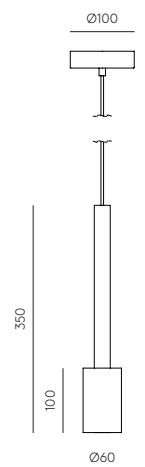



MARU

DESIGNED BY JF SEVILLA, 2015 · C1194

ES

ACABADOS

Metal:
Negro Mate - Oro Mate
Negro Mate - Negro Mate

MATERIALES

Acero

ESPECIFICACIONES (UE)

LED integrado
3W - 3150K
12 V, 50/60 Hz
IP20, Clase I



CLASIFICACIÓN ENERGÉTICA

A ++

EN

FINISHES

Metal:
Matt Black - Matt Brass
Matt Black - Matt Black

MATERIALS

Steel

SPECIFICATIONS (UE)

Integrated LED
3W - 3150K
12 V, 50/60 Hz
IP20, Class I



ENERGY LABEL

A ++

TEC

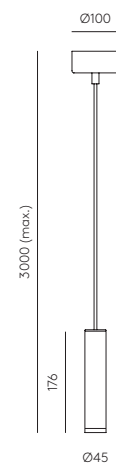

DAMO

DESIGNED BY AC STUDIO, 2015 · C1191

ES

ACABADOS

Metal:
Negro Mate
Oro Mate

Difusor:
Cristal Opal

MATERIALES

Acero / Cristal

ESPECIFICACIONES (UE)

2 x E27 Max. 60W
(No incluida)
220-240 V, 50/60 Hz
IP20, Clase I



CLASIFICACIÓN ENERGÉTICA

A ++

BOMBILLAS RECOMENDADAS

B211 (7, 9, 11W)

EN

FINISHES

Metal:
Matt Black
Matt Brass

Diffuser:
Opal

MATERIALS

Steel / Glass

SPECIFICATIONS (UE)

2 x E27 Max. 60W
(Not included)
220-240 V, 50/60 Hz
IP20, Class I



ENERGY LABEL

A ++

RECOMMENDED BULBS

B211 (7, 9, 11W)

TEC

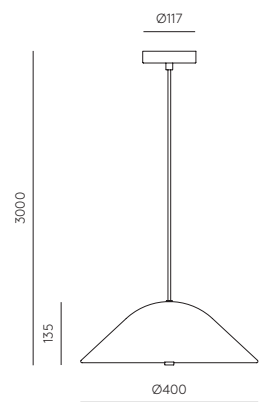



LESS

DESIGNED BY FORNASEVI, 2014 · C1171

ES

ACABADOS
Metal:
Oro Mate
Cromo
Negro Mate

MATERIALES
Acero

ESPECIFICACIONES (UE)
E27 Max. 60W
(No incluida)
220-240 V, 50/60 Hz
IP20, Clase I



CLASIFICACIÓN ENERGÉTICA
A ++

BOMBILLA IMAGEN
B035/ORO

EN

FINISHES
Metal:
Matt Brass
Chrome
Matt Black

MATERIALS
Steel

SPECIFICATIONS (UE)
E27 Max. 60W
(Not included)
220-240 V, 50/60 Hz
IP20, Class I



ENERGY LABEL
A ++

BULB IMAGE
B035/GOLD

TEC

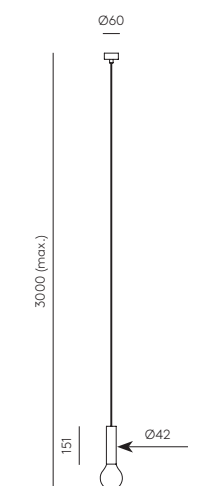



DODO

DESIGNED BY JANA CHANG, 2014 · C1169

ES

ACABADOS
Metal:
Negro Mate
Blanco Mate

MATERIALES
Acero

ESPECIFICACIONES (UE)
E27 Max. 60W
(No incluida)
220-240 V, 50/60 Hz
IP20, Clase I



CLASIFICACIÓN ENERGÉTICA
A ++

BOMBILLAS RECOMENDADAS
B211 (7, 9, 11W)

EN

FINISHES
Metal:
Matt Black
Matt White

MATERIALS
Steel

SPECIFICATIONS (UE)
E27 Max. 60W
(Not included)
220-240 V, 50/60 Hz
IP20, Class I



ENERGY LABEL
A ++

RECOMMENDED BULBS
B211 (7, 9, 11W)

TEC

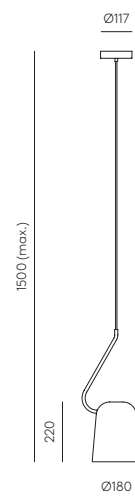

ELLA

DESIGNED BY AC STUDIO, 2020 · C1158

ES

ACABADOS
Cúpula grande:
Negro Mate - Exterior
Blanco Mate - Interior

MATERIALES
Metal / Acrílico

ESPECIFICACIONES (UE)
LED integrado 9W 3000K
(Incluida)
12V / 220-240 V, 50/60 Hz
IP20



CLASIFICACIÓN ENERGÉTICA
A ++

Difusor:
Negro Mate
Oro mate
Cromo

EN

FINISHES
Big Dome:
Matt Black - Exterior
Matt White - Interior

MATERIALS
Metal / Acrylic

SPECIFICATIONS (UE)
LED integrado 9W 3000K
(Included)
12V / 220-240 V, 50/60 Hz
IP20



ENERGY LABEL
A ++

Diffuser:
Matt Black
Matt Brass
Chrome

TEC

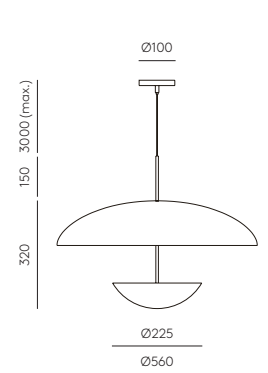



ENDO

DESIGNED BY PEPE FORNAS, 2013 · C1156

ES

ACABADOS
Metal:
Negro Mate
Cromo

MATERIALES
Acero

ESPECIFICACIONES (UE)
Bombillas G9 LED (Incluidas)
6 x 5W - 2700K
220-240 V, 50/60 Hz
IP20, Clase I



CLASIFICACIÓN ENERGÉTICA
A ++

BOMBILLAS RECOMENDADAS
B005 / 5W

EN

FINISHES
Metal:
Matt Black
Chrome

MATERIALS
Steel

SPECIFICATIONS (UE)
G9 LED Bulbs (Included)
6 x 5W - 2700K
220-240 V, 50/60 Hz
IP20, Class I



ENERGY LABEL
A ++

RECOMMENDED BULBS
B005 / 5W

TEC

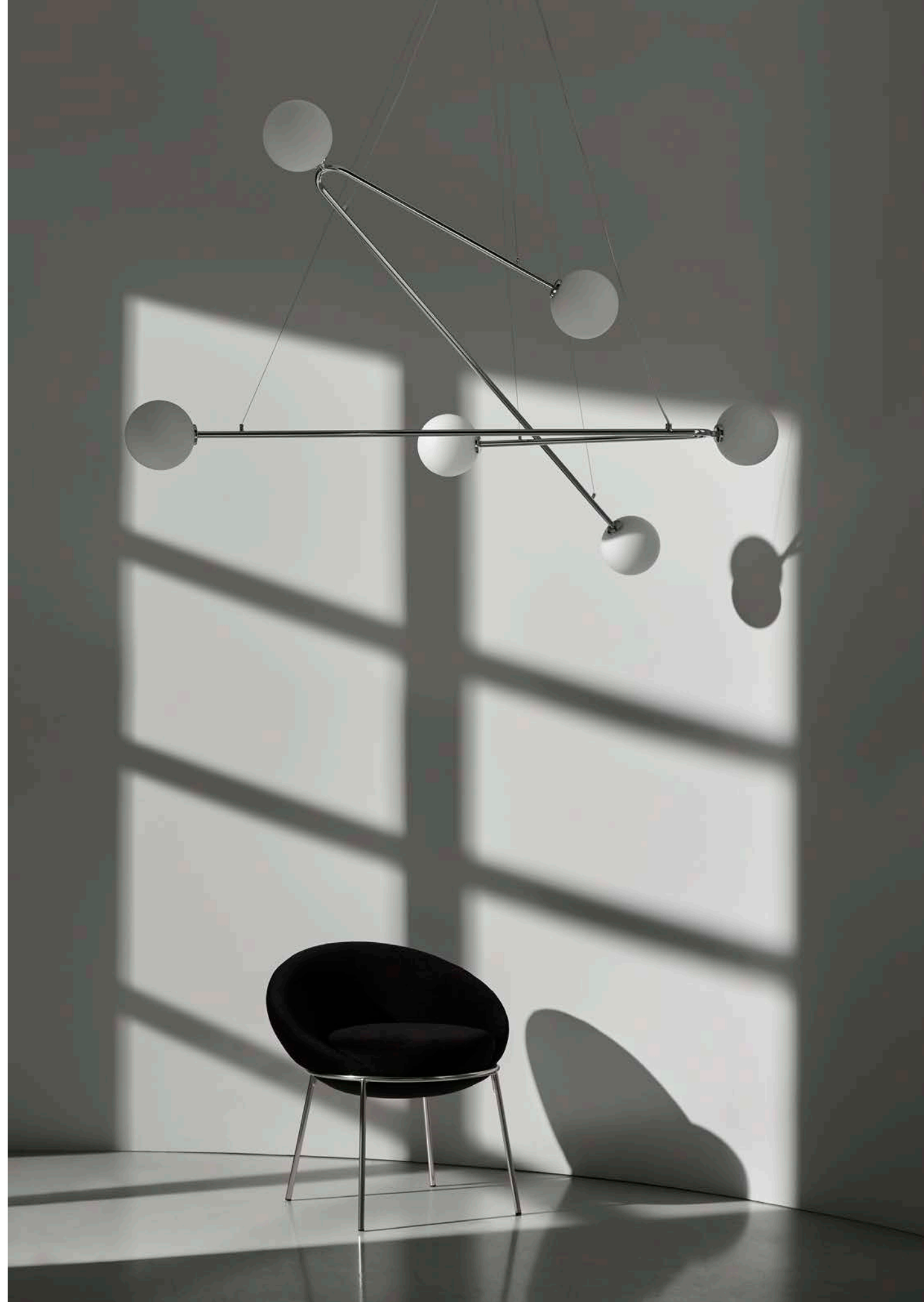
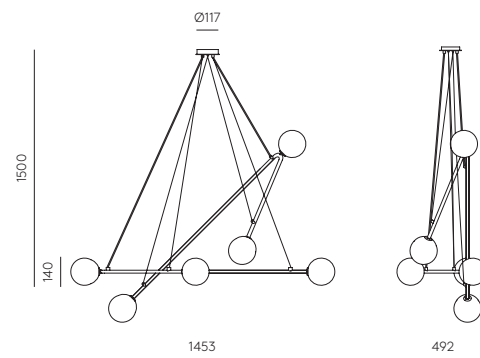



PTAN

DESIGNED BY FORNASEVI, 2018 · C1154

ES

ACABADOS

Metal:
Oro Mate
Negro Mate

Ratán:
Natural/Negro
Natural/Negro

MATERIALES
Acero / Ratán

ESPECIFICACIONES (UE)
E27 Max. 60W
(No incluida)
220-240 V, 50/60 Hz
IP20, Clase I



CLASIFICACIÓN ENERGÉTICA
A ++

BOMBILLAS RECOMENDADAS
B033/COB (Opal)
B035/ORO (Espejada)

EN

FINISHES

Metal:
Matt Brass
Matt Black

Rattan:
Natural/Black
Natural/Black

MATERIALS
Steel / Rattan

SPECIFICATIONS (UE)
E27 Max. 60W
(Not included)
220-240 V, 50/60 Hz
IP20, Class I



ENERGY LABEL
A ++

RECOMMENDED BULBS
B033/COB (Opal)
B035/ORO (Mirrored)

TEC

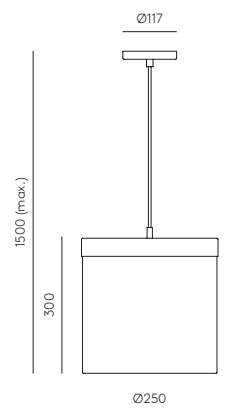





ANYA

DESIGNED BY FORNASEVI, 2020 · C1010 + 1143 / 1144

ES

ACABADOS

C1010:
Oro Mate
Negro Mate

Pantalla 1143/1144:
Bambú/Negro
Bambú/Bronce

MATERIALES

Bambú Natural / Acero

ESPECIFICACIONES (UE)

E27 Max. 60W (No incluida)
220-240 V, 50/60 Hz
IP20, Clase I



CLASIFICACIÓN ENERGÉTICA

A ++

MODIFICACIONES POSIBLES

Pantalla 1144 (Diámetro 50 cm)
Variante aplique con soporte
A1053 + pantalla

BOMBILLA RECOMENDADA
B052

EN

FINISHES

C1010:
Matt Brass
Matt Black

Shade 1143/1144:
Bamboo/Black
Bamboo/Black

MATERIALS

Natural Bamboo / Steel

SPECIFICATIONS (UE)

E27 Max. 60W (Not included)
220-240 V, 50/60 Hz
IP20, Class I



ENERGY LABEL

A ++

POSSIBLE MODIFICATIONS

Shade 1144 (Diameter 50 cm)
Possibility to make in wall lamp with
A1053 fitting + shade

RECOMMENDED BULB
B052

TEC

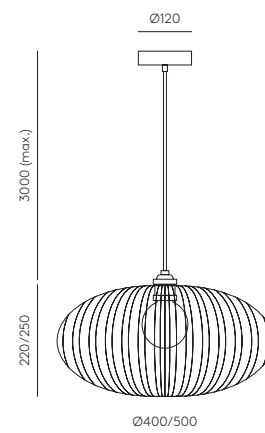

PAGO

DESIGNED BY PEPE FORNAS, 2010 · C1126

ES

ACABADOS

Metal:
Negro Brillo - Oro Brillo
Blanco Brillo - Cromo

MATERIALES

Acero

ESPECIFICACIONES (UE)

GU10 Max. 50W
(No incluida)
220-240 V, 50/60 Hz
IP20, Clase I



CLASIFICACIÓN ENERGÉTICA

A ++

BOMBILLA RECOMENDADA
B161

EN

FINISHES

Metal:
Shinny Black - Shinny Gold
Shinny White - Chrome

MATERIALS

Steel

SPECIFICATIONS (UE)

GU10 Max. 50W
(Not included)
220-240 V, 50/60 Hz
IP20, Class I



ENERGY LABEL

A ++

RECOMMENDED BULBS
B161

TEC

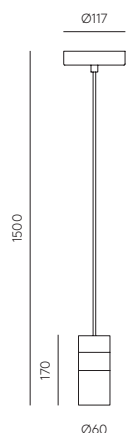



HEDULA

DESIGNED BY AC STUDIO, 2020 · C1010 + 1160

ES

ACABADOS

C1010: Oro Mate Médula: Negro Mate
 Negro Mate

MATERIALES

Metal / Médula Natural

ESPECIFICACIONES (UE)

E27 max. 60W(No incluida)
 220-240 V, 50/60 Hz

IP20

CLASIFICACIÓN ENERGÉTICA

A ++

BOMBILLA RECOMENDADA

300 mm - B052
 600 mm - B033/COB
 900 mm - B033/COB

EN

FINISHES

C1010: Matt Brass Fiber: Matt Black
 Matt Black

MATERIALS

Metal / Natural Fiber

SPECIFICATIONS (UE)

E27 max. 60W(No incluida)
 220-240 V, 50/60 Hz

IP20

ENERGY LABEL

A ++

RECOMMENDED BULB

300 mm - B052
 600 mm - B033/COB
 900 mm - B033/COB

TEC

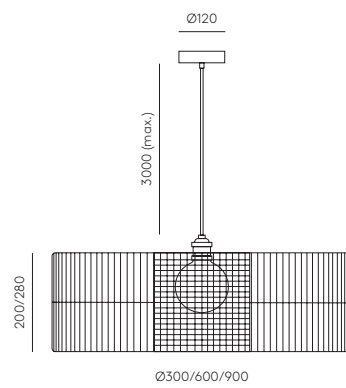



ALPHA

DESIGNED BY AC STUDIO, 2019 · C1083

ES

ACABADOS

Metal:
Negro
Oro
Cromo

Tulipa:
Paleta Colores
Ver posibilidades de color en pág. 372

MATERIALES

Acero

ESPECIFICACIONES (UE)

E27 Max. 60W
(No incluida)
220-240 V, 50/60 Hz
IP20, Clase I



CLASIFICACIÓN ENERGÉTICA

A ++

MODIFICACIONES POSIBLES

Acabado especial - Sobrecoste

BOMBILLA RECOMENDADA

B211 (7, 9, 11W)

EN

FINISHES

Metal:
Black
Gold
Chrome

Shade:
Color Palette
See color options on page 372

MATERIALS

Steel

SPECIFICATIONS (UE)

E27 Max. 60W
(Not included)
220-240 V, 50/60 Hz
IP20, Class I



ENERGY LABEL

A ++

POSSIBLE MODIFICATIONS

Special finish - Extracost

RECOMMENDED BULB

B211 (7, 9, 11W)

TEC

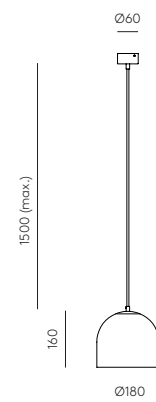

BETA

DESIGNED BY AC STUDIO, 2019 · C1082

ES

ACABADOS

Metal:
Negro
Oro
Cromo

Tulipa:
Paleta Colores
Ver posibilidades de color en pág. 369

MATERIALES

Acero

ESPECIFICACIONES (UE)

E27 Max. 60W (No incluida)
220-240 V, 50/60 Hz, IP20,
Clase I



CLASIFICACIÓN ENERGÉTICA

A ++

MODIFICACIONES POSIBLES

Acabado especial - Sobrecoste

BOMBILLA RECOMENDADA

B033/COB

EN

FINISHES

Metal:
Black
Gold
Chrome

Shade:
Color Palette
See color options on page 369

MATERIALS

Steel

SPECIFICATIONS (UE)

E27 Max. 60W (Not included)
220-240 V, 50/60 Hz, IP20,
Class I



ENERGY LABEL

A ++

POSSIBLE MODIFICATIONS

Special finish - Extracost

RECOMMENDED BULB

B033/COB

TEC

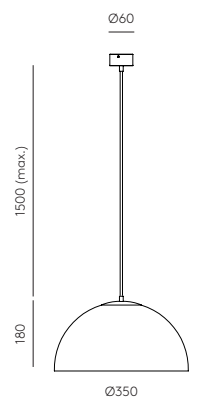

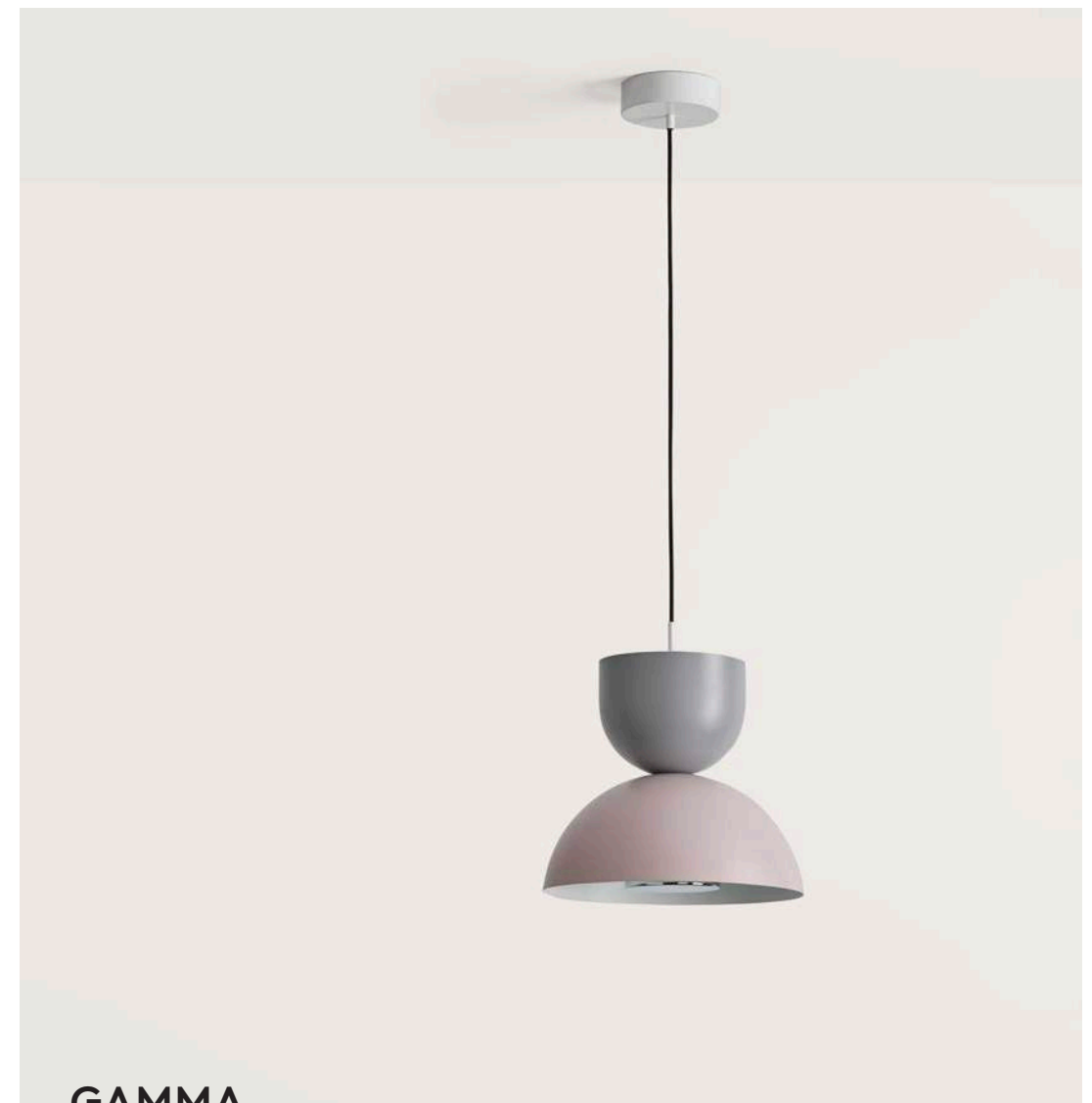

GAMMA

DESIGNED BY AC STUDIO, 2019 · C1081

ES

ACABADOS

Tulipa:
Paleta Colores
Ver posibilidades de
color en pág. 372

Difusor:
Negro
Cromo

MATERIALES

Acero

ESPECIFICACIONES (UE)

Difusor Led 9W - 3000K
12 V, 50/60 Hz, IP20, Clase I



CLASIFICACIÓN ENERGÉTICA

A ++

MODIFICACIONES POSIBLES

Acabado especial - Sobrecoste
Portalámparas E27

BOMBILLA RECOMENDADA
B033/COB

EN

FINISHES

Shade:
Color Palette
See color options
on page 372

Diffuser:
Black
Chrome

MATERIALS

Steel

SPECIFICATIONS (UE)

Led Diffuser 9W - 3000K
12 V, 50/60 Hz, IP20, Class I



ENERGY LABEL

A ++

POSSIBLE MODIFICATIONS

Special finish - Extracost
E27 Lamp holder

RECOMMENDED BULB
B033/COB

TEC

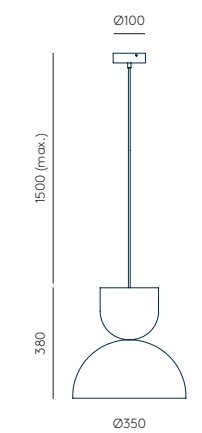



ELLEN

DESIGNED BY AC STUDIO, 2014 · C1048

ES

ACABADOS

Metal:

Negro
Blanco
Oro brillo
Cromo

MATERIALES

Acero

ESPECIFICACIONES (UE)

E27 Max. 60W (No incluida)
220-240 V, 50/60 Hz
IP20, Clase I



CLASIFICACIÓN ENERGÉTICA

A ++

BOMBILLAS RECOMENDADAS

B019

EN

FINISHES

Metal:

Black
White
Shiny Gold
Chrome

MATERIALS

Steel

SPECIFICATIONS (UE)

E27 Max. 60W (Not included)
220-240 V, 50/60 Hz
IP20, Class I



ENERGY LABEL

A ++

RECOMMENDED BULBS

B019

TEC

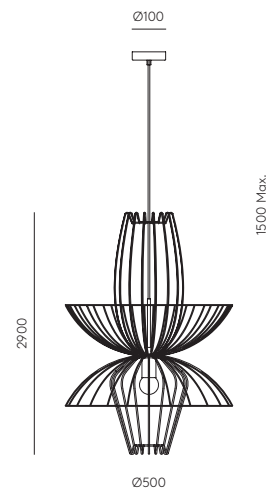

CRAWFORD

DESIGNED BY PEPE FORNAS, 2014 · C1047

ES

ACABADOS

Metal:

Negro
Blanco
Oro brillo
Cromo

MATERIALES

Acero

ESPECIFICACIONES (UE)

E27 Max. 60W (No incluida)
220-240 V, 50/60 Hz
IP20, Clase I



CLASIFICACIÓN ENERGÉTICA

A ++

BOMBILLA RECOMENDADA

B033

EN

FINISHES

Metal:

Black
White
Shiny Gold
Chrome

MATERIALS

Steel

SPECIFICATIONS (UE)

E27 Max. 60W (Not included)
220-240 V, 50/60 Hz
IP20, Class I



ENERGY LABEL

A ++

RECOMMENDED BULB

B033

TEC

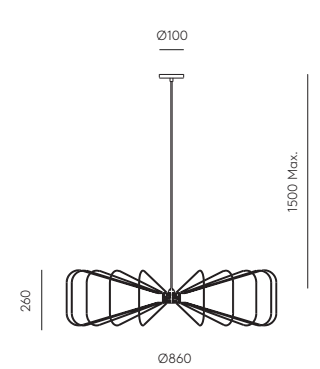



DISC

DESIGNED BY JF SEVILLA, 2014 · C1038

ES

ACABADOS

Metal:
Negro
Blanco
Oro Brillo
Cromo

MATERIALES

Acero

ESPECIFICACIONES (UE)

E27 Max. 60W (No incluida)
220-240 V, 50/60 Hz
IP20, Clase I



CLASIFICACIÓN ENERGÉTICA

A ++

MODIFICACIONES POSIBLES

Medidas disco Ø15, Ø25, Ø35 cm

BOMBILLA IMAGEN

B035/ORO

EN

FINISHES

Metal:
Black
White
Shinny Gold
Chrome

MATERIALS

Steel

SPECIFICATIONS (UE)

E27 Max. 60W (Not included)
220-240 V, 50/60 Hz
IP20, Class I



ENERGY LABEL

A ++

POSSIBLE MODIFICATIONS

Disc sizes Ø15, Ø25, Ø35 cm

BULB IMAGE

B035/GOLD

TEC

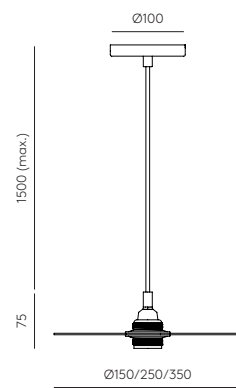



OPEN

DESIGNED BY AC STUDIO, 2009 · C1024

ES

ACABADOS

Tela: Blanco
Difusor: Blanco
Metal: Cromo
 Gris
 Negro

MATERIALES

Loneta de Algodón / Acero

ESPECIFICACIONES (UE)

3 x E27 Max. 60W (No incluida)
 220-240 V, 50/60 Hz
 IP20, Clase I



CLASIFICACIÓN ENERGÉTICA

A ++

BOMBILLAS RECOMENDADAS

B211 (7, 9, 11W)

EN

FINISHES

Metal: White
Diffuser: White
Metal: Chrome
 Grey
 Black

MATERIALS

Fabric Cotton / Steel

SPECIFICATIONS (UE)

3 x E27 Max. 60W (Not included)
 220-240 V, 50/60 Hz
 IP20, Class I



ENERGY LABEL

A ++

RECOMMENDED BULBS

B211 (7, 9, 11W)

TEC

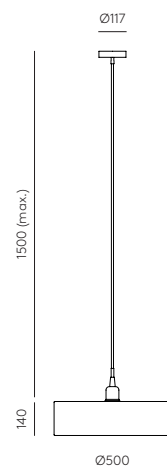

C 1012

DESIGNED BY AGUSTÍN GASCÓN · C1012 + B055

ES

ACABADOS

Metal: Negro Mate
Cristal: Transparente
 Fumé Negro

MATERIALES

Metal / Vidrio

ESPECIFICACIONES (UE)

E27 3W 3000K (Incluida)
 220-240 V, 50/60 Hz



CLASIFICACIÓN ENERGÉTICA

A ++

PORTALÁMPARAS Y BOMBILLA
 SE VENDEN POR SEPARADO

EN

FINISHES

Metal: Matt Black
Glass: Clear
 Black Smoked

MATERIALS

Metal / Glass

SPECIFICATIONS (UE)

E27 3W 3000K (Included)
 220-240 V, 50/60 Hz



ENERGY LABEL

A ++

LAMP HOLDER AND BULB
 SOLD INDIVIDUALLY

TEC

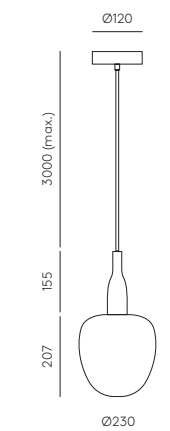



TAMB SQUARE

DESIGNED BY AC STUDIO, 2010 · T1016

ES

ACABADOS

Tela: Blanco
Difusor: Blanco
Gris
Negro

MATERIALES

Loneta de Algodón

ESPECIFICACIONES (UE)

2 x E27 Max. 60W (No incluida)
220-240 V, 50/60 Hz
IP20, Clase I



CLASIFICACIÓN ENERGÉTICA

A ++

BOMBILLAS RECOMENDADAS

B211 (7, 9, 11W)

EN

FINISHES

Metal: White
Diffuser: White
Grey
Black

MATERIALS

Fabric Cotton

SPECIFICATIONS (UE)

2 x E27 Max. 60W (Not included)
220-240 V, 50/60 Hz
IP20, Class I



ENERGY LABEL

A ++

RECOMMENDED BULBS

B211 (7, 9, 11W)

TEC

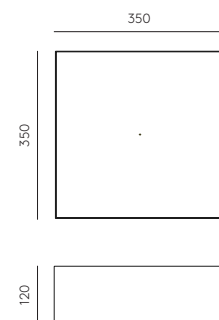

TAMB 30-50

DESIGNED BY AC STUDIO, 2011 · T1019-30 / T1019-50

ES

ACABADOS

Tela: Blanco
Difusor: Blanco
Gris
Negro

MATERIALES

Loneta de Algodón

ESPECIFICACIONES (UE)

2 x E27 Max. 60W
(No incluida)
220-240 V, 50/60 Hz
IP20, Clase I



CLASIFICACIÓN ENERGÉTICA

A ++

BOMBILLAS RECOMENDADAS

B211 (7, 9, 11W)

EN

FINISHES

Fabric: White
Diffuser: White
Grey
Black

MATERIALS

Fabric Cotton

SPECIFICATIONS (UE)

2 x E27 Max. 60W
(Not included)
220-240 V, 50/60 Hz
IP20, Class I



ENERGY LABEL

A ++

RECOMMENDED BULBS

B211 (7, 9, 11W)

TEC

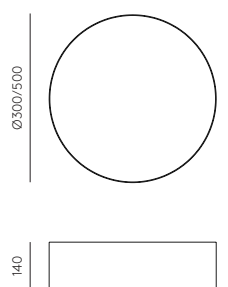

Floor lamps

222	FITO	247	ARIO
224	FOCUS	248	NERA
225	ITO	250	ATOM
226	LYB	252	COHEN/COHEN GOLD
229	AITO	255	MARU
230	COLN	256	LUA/BOA
232	HINOO	257	TRIPOD II
234	WONG	258	DODO
236	ABBACUS	260	ENDO
238	ARTIC	262	RIU
240	COT	263	PAGO
242	FICUS	264	ONA
243	OHLALA	265	TEX
246	LUCA	267	TRIP



FITO

DESIGNED BY PEPE FORNAS, 2020 · P1286

ES

ACABADOS

Metal: Negro Mate
Rejilla: Oro Mate
Base: Mármol Negro

MATERIALES

Acero / Mármol

ESPECIFICACIONES (UE)

T8 Led 14W (Incluido)
 3000K
 220-240 V, 50/60 Hz
 IP20, Clase II

IP20

CLASIFICACIÓN ENERGÉTICA

A ++

BOMBILLAS RECOMENDADA

T8/14W

EN

FINISHES

Metal: Matt Black
Rack: Matt Brass
Base: Black Marble

MATERIALS

Steel / Marble

SPECIFICATIONS (UE)

T8 Led 14W (Included)
 3000K
 220-240 V, 50/60 Hz
 IP20, Class II

IP20

ENERGY LABEL

A ++

RECOMMENDED BULB

T8/14W

TEC

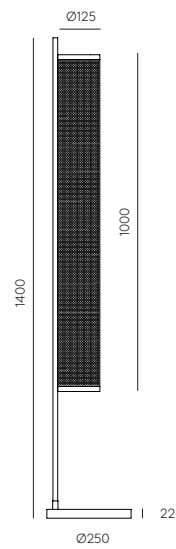



FOCUS

DESIGNED BY PEPE FORNAS, 2019 · P1279

ES

ACABADOS

Cuerpo:
Negro Mate
Negro Mate

Cabeza:
Oro Viejo
Antracita

MATERIALES

Acero / Aluminio

ESPECIFICACIONES (UE)

Bombilla GU10 Led (Incluida)
5W - 3000K
220-240 V, 50/60 Hz
IP20, Clase II



CLASIFICACIÓN ENERGÉTICA

A ++

MODIFICACIONES POSIBLES

Cabezal de alabastro

BOMBILLAS RECOMENDADAS

B161

EN

FINISHES

Body:
Matt Black
Matt Black

Head:
Aged Gold
Anthracite

MATERIALS

Steel / Aluminium

SPECIFICATIONS (UE)

GU10 Led Bulb (Included)
5W - 3000K
220-240 V, 50/60 Hz
IP20, Class II



ENERGY LABEL

A ++

POSSIBLE MODIFICATIONS

Alabaster head

RECOMMENDED BULBS

B161

TEC

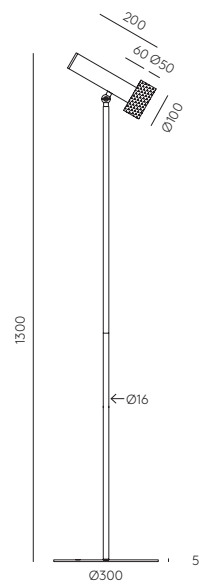

ITO

DESIGNED BY PEPE FORNAS, 2019 · P1277

ES

ACABADOS

Cuerpo:
Negro Mate

Base:
Granito Gris

MATERIALES

Acero / Granito

ESPECIFICACIONES (UE)

E27 Max. 60W
(No incluida)
220-240 V, 50/60 Hz
IP20, Clase II



CLASIFICACIÓN ENERGÉTICA

A ++

MODIFICACIONES POSIBLES

Pantalla imagen
801021/41 Negro
Pantalla no incluida

BOMBILLAS RECOMENDADAS

B211 (7, 9, 11W)

EN

FINISHES

Body:
Matt Black

Base:
Terrazzo Grey

MATERIALS

Steel / Terrazzo

SPECIFICATIONS (UE)

E27 Max. 60W
(Not included)
220-240 V, 50/60 Hz
IP20, Class II



ENERGY LABEL

A ++

POSSIBLE MODIFICATIONS

Recommended shade
801021/41 Black
Shade not included

RECOMMENDED BULBS

B211 (7, 9, 11W)

TEC

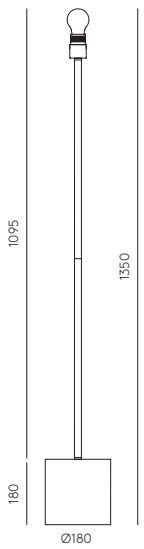





LYB

DESIGNED BY PEPE FORNAS, 2019 · P1274

ES

ACABADOS
Metal:
Negro Mate

MATERIALES
Acero

ESPECIFICACIONES (UE)
Chip Led regulable incluido 5W,
3000K
12 V, 50/60 Hz
IP20, Clase II



CLASIFICACIÓN ENERGÉTICA
A ++

TOUCH ME REGULABLE

EN

FINISHES
Metal:
Matt Black

MATERIALS
Steel

SPECIFICATIONS (UE)
Chip Led dimmable integrated 5W,
3000K
12 V, 50/60 Hz
IP20, Class II



ENERGY LABEL
A ++

TOUCH ME DIMMABLE

TEC

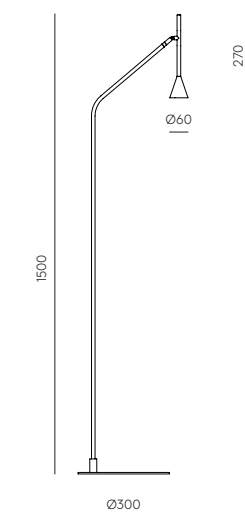

AITO

DESIGNED BY PEPE FORNAS, 2019 · P1270

ES

ACABADOS
Metal:
Negro Mate Madera:
Nogal

MATERIALES
Acero / Nogal

ESPECIFICACIONES (UE)
E27 Max. 60W (No incluida)
220-240 V, 50/60 Hz
IP20, Clase II



BOMBILLA RECOMENDADA
B211 (7, 9, 11W)

EN

FINISHES
Metal:
Matt Black Wood:
Walnut

MATERIALS
Steel / Walnut

SPECIFICATIONS (UE)
E27 Max. 60W (Not included)
220-240 V, 50/60 Hz
IP20, Class II



RECOMMENDED BULB
B211 (7, 9, 11W)

TEC

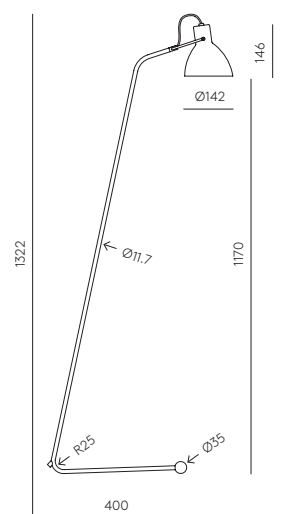



COLN

DESIGNED BY AC STUDIO, 2019 · P1267

ES

ACABADOS
Metal: Negro Mate Mármol: Negro

MATERIALES
Acero / Mármol

ESPECIFICACIONES (UE)
Tira Led
24 V, 50/60 Hz, IP20, Clase II
15W - 3000K



CLASIFICACIÓN ENERGÉTICA
A ++

CONSULTAR OPCIONES DE REGULACIÓN EN TARIFA

EN

FINISHES
Metal: Matt Black Marble: Black

MATERIALS
Steel / Marble

SPECIFICATIONS (UE)
Strip Led
24 V, 50/60 Hz, IP20, Class II
15W - 3000K



ENERGY LABEL
A ++

ASK US FOR DIMMER OPTIONS
PRICE LIST

TEC

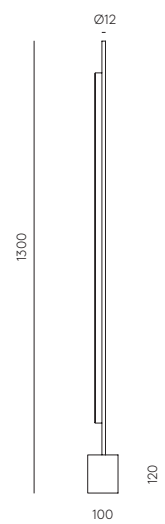



HINOO

DESIGNED BY JF SEVILLA, 2021 · P1266

ES

ACABADOS

Metal:
Negro Mate
Negro Mate - Detalles
Oro mate

Base:
Mármol Negro
Mármol Blanco

MATERIALES

Acero / Mármol / Acrílico

ESPECIFICACIONES (UE)

LED integrado Regulable
13W 3000K, 9-21V, 50/60 Hz,
IP20, Clase II



CLASIFICACIÓN ENERGÉTICA

A ++

REGULADOR DE PIE EN CABLE

EN

FINISHES

Metal:
Matt Black
Matt Black - Details
Matt Brass

Base:
Black Marble
White Marble

MATERIALS

Steel / Marble / Acrylic

SPECIFICATIONS (UE)

Integrated Dimmable LED
13W 3000K, 9-21V, 50/60 Hz,
IP20, Class II



ENERGY LABEL

A ++

DIMMER ON CABLE

TEC

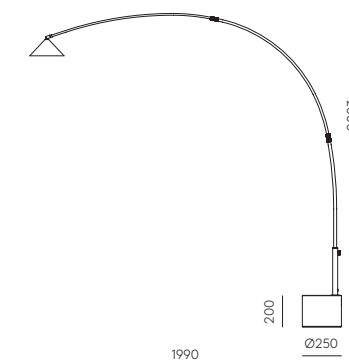



WONG

DESIGNED BY PEPE FORNAS, 2018 · P1263

ES

ACABADOS

Metal: Negro Mate
Piel Marrón

Cristal (Incluido): Opal

MATERIALES

Acero / Vidrio Soplado / Cuero

ESPECIFICACIONES (UE)

3 x G9 Led - 5W
2700K (Incluida)
220-240 V, 50/60 Hz
IP20, Clase II



CLASIFICACIÓN ENERGÉTICA

A ++

BOMBILLAS INCLUIDAS

B005/5W

EN

FINISHES

Metal: Matt Black
Brown Leather

Shade (Included): Opal

MATERIALS

Steel / Blown Glass / Leather

SPECIFICATIONS (UE)

3 x G9 Led - 5W
2700K (Included)
220-240 V, 50/60 Hz
IP20, Class II



ENERGY LABEL

A ++

BULBS INCLUDED

B005/5W

TEC

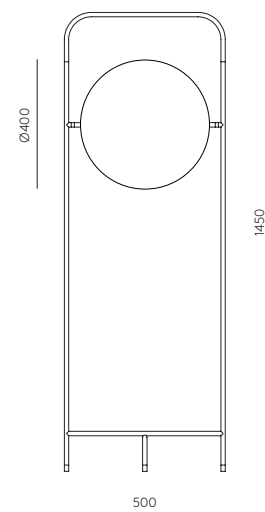



ABBACUS

DESIGNED BY PEPE FORNAS, 2018 · P1258

ES

ACABADOS

Metal:
Cromo
Negro Mate
Oro Mate

Cristal (Incluido):
Opal/Transparente
Opal/Transparente
Opal/Transparente

MATERIALES

Acero / Vidrio Soplado

ESPECIFICACIONES (UE)

Bombilla G9 (Incluida)
5W - 2700K
220-240 V, 50/60 Hz
IP20, Clase II

IP20 CE RoHS A++

CLASIFICACIÓN ENERGÉTICA

A ++

BOMBILLA INCLUIDA

B005/5W

EN

FINISHES

Metal:
Chrome
Matt Black
Matt Brass

Glass Shade (Included):
Opal/Clear
Opal/Clear
Opal/Clear

MATERIALS

Steel / Blown Glass

SPECIFICATIONS (UE)

Bulb G9 (Included)
5W - 2700K
220-240 V, 50/60 Hz
IP20, Class II

IP20 CE RoHS A++

ENERGY LABEL

A ++

BULB INCLUDED

B005/5W

TEC

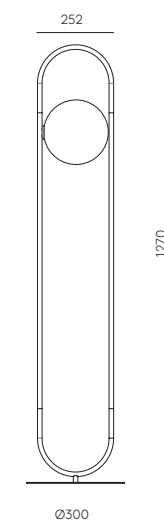

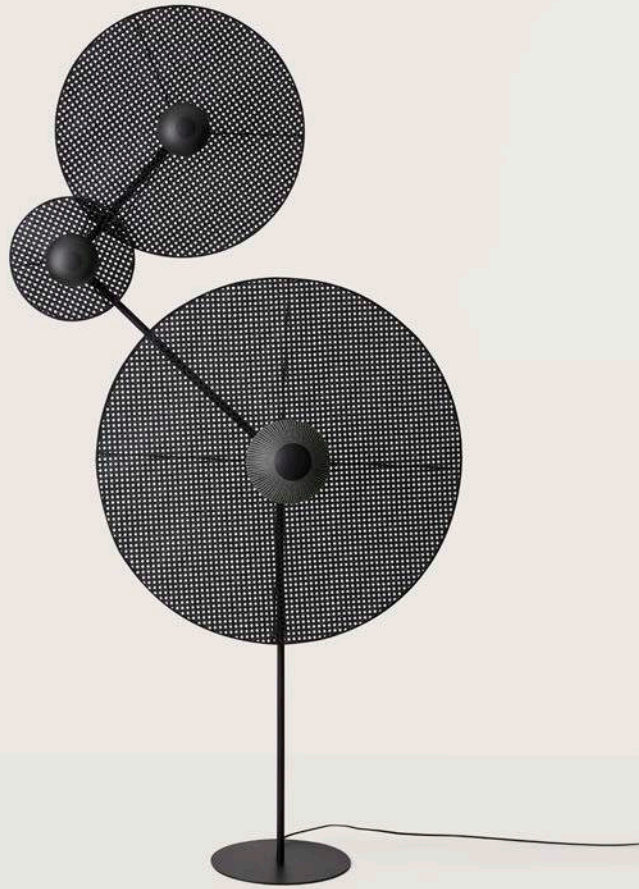

ARTIC

DESIGNED BY PEPE FORNAS, 2020 · P1256

ES

ACABADOS
Metal:
Negro Mate

Portalámparas:
Oro Mate

MATERIALES
Acero

ESPECIFICACIONES (UE)
3 x E27 (Bombillas no incluidas)
220-240 V, 50/60 Hz
IP20, Clase II



CLASIFICACIÓN ENERGÉTICA
A ++

ACCESORIOS
Accesorio imagen 1125 -
30, 60, 90 cm (No incluido)

BOMBILLAS IMAGEN
B048 (G125) / B047 (G95)

EN

FINISHES
Metal:
Matt Black

Lampholder:
Matt Brass

MATERIALS
Steel

SPECIFICATIONS (UE)
3 x E27 (Bulbs not included)
220-240 V, 50/60 Hz
IP20, Class II



ENERGY LABEL
A ++

ACCESSORIES
Image reference accessory 1125 -
30, 60, 90 cm (Not included)

BULBS INCLUDED
B048 (G125) / B047 (G95)

TEC

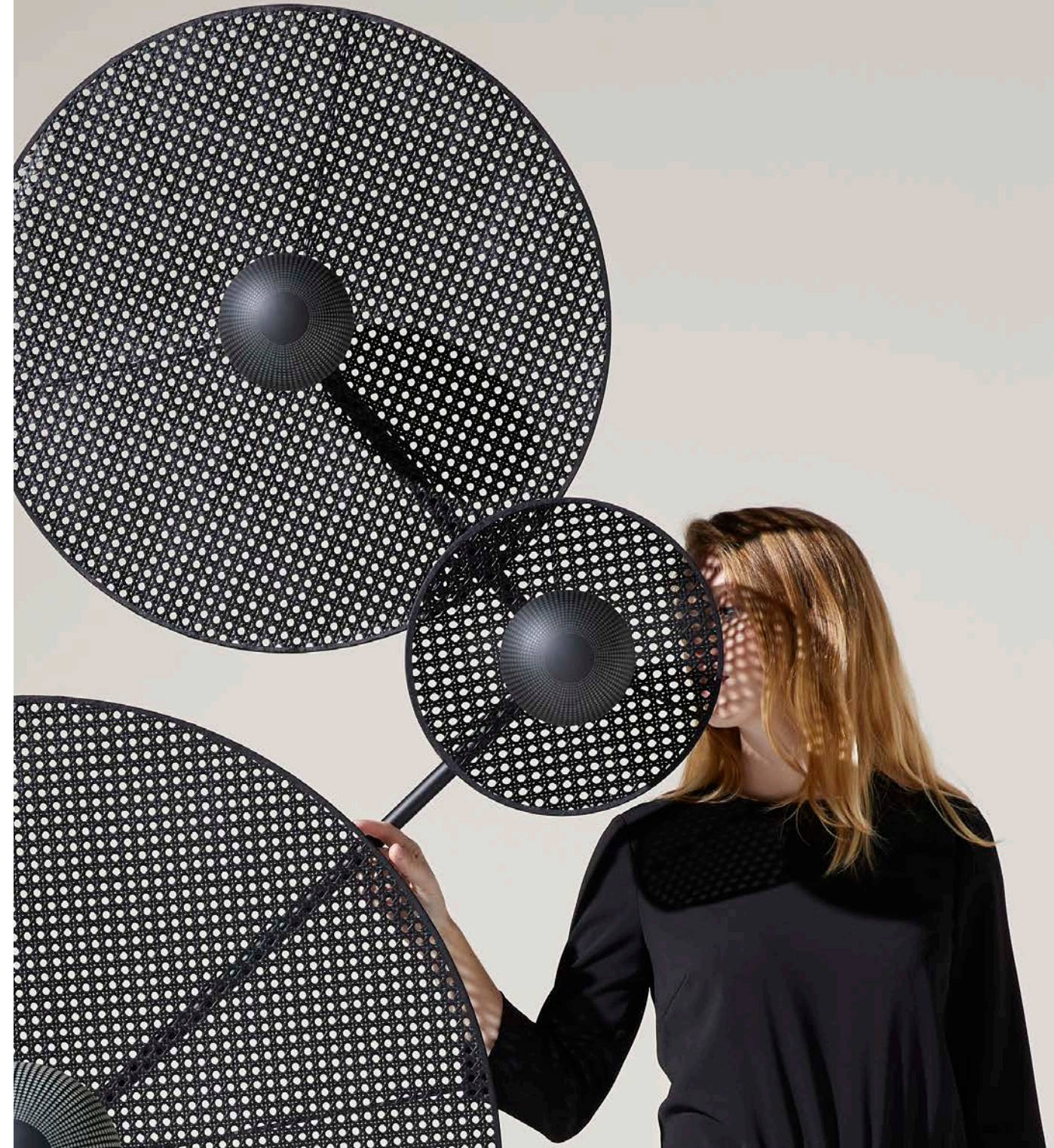
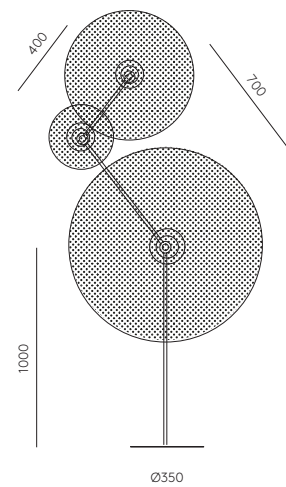



COT

DESIGNED BY AC STUDIO, 2018 · P1251

ES

ACABADOS

Madera: Nogal
 Pantalla: Negra
 Nogal Blanca

MATERIALES

Acero / Nogal / Algodón

ESPECIFICACIONES (UE)

E27 Max. 60W
 (No incluida)
 220-240 V, 50/60 Hz
 IP20, Clase II



CLASIFICACIÓN ENERGÉTICA

A ++

PANTALLA INCLUIDA

BOMBILLA RECOMENDADA
 B211 (7, 9, 11W)

EN

FINISHES

Wood: Walnut
 Shade: Black
 Walnut White

MATERIALS

Steel / Walnut Wood / Cotton

SPECIFICATIONS (UE)

E27 Max. 60W
 (Not included)
 220-240 V, 50/60 Hz
 IP20, Class II



ENERGY LABEL

A ++

SHADE INCLUDED

RECOMMENDED BULB
 B211 (7, 9, 11W)

TEC

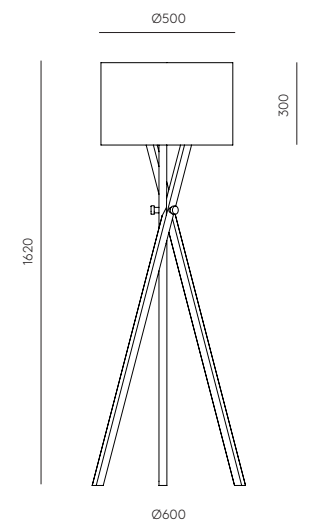



FICUS

DESIGNED BY JF SEVILLA, 2017 · P1243

ES

ACABADOS

Metal: Negro Mate
Tulipa: Oro Mate

MATERIALES
Acero

ESPECIFICACIONES (UE)

Bombilla G9 (Incluida)
5W - 2700K
220-240 V, 50/60 Hz
IP20, Clase II



CLASIFICACIÓN ENERGÉTICA
A ++

BOMBILLA INCLUIDA
B005/5W

EN

FINISHES

Metal: Matt Black
Shade: Matt Brass

MATERIALS
Steel

SPECIFICATIONS (UE)

Bulb G9 (Included)
5W - 2700K
220-240 V, 50/60 Hz
IP20, Class II



ENERGY LABEL
A ++

BULB INCLUDED
B005/5W

TEC

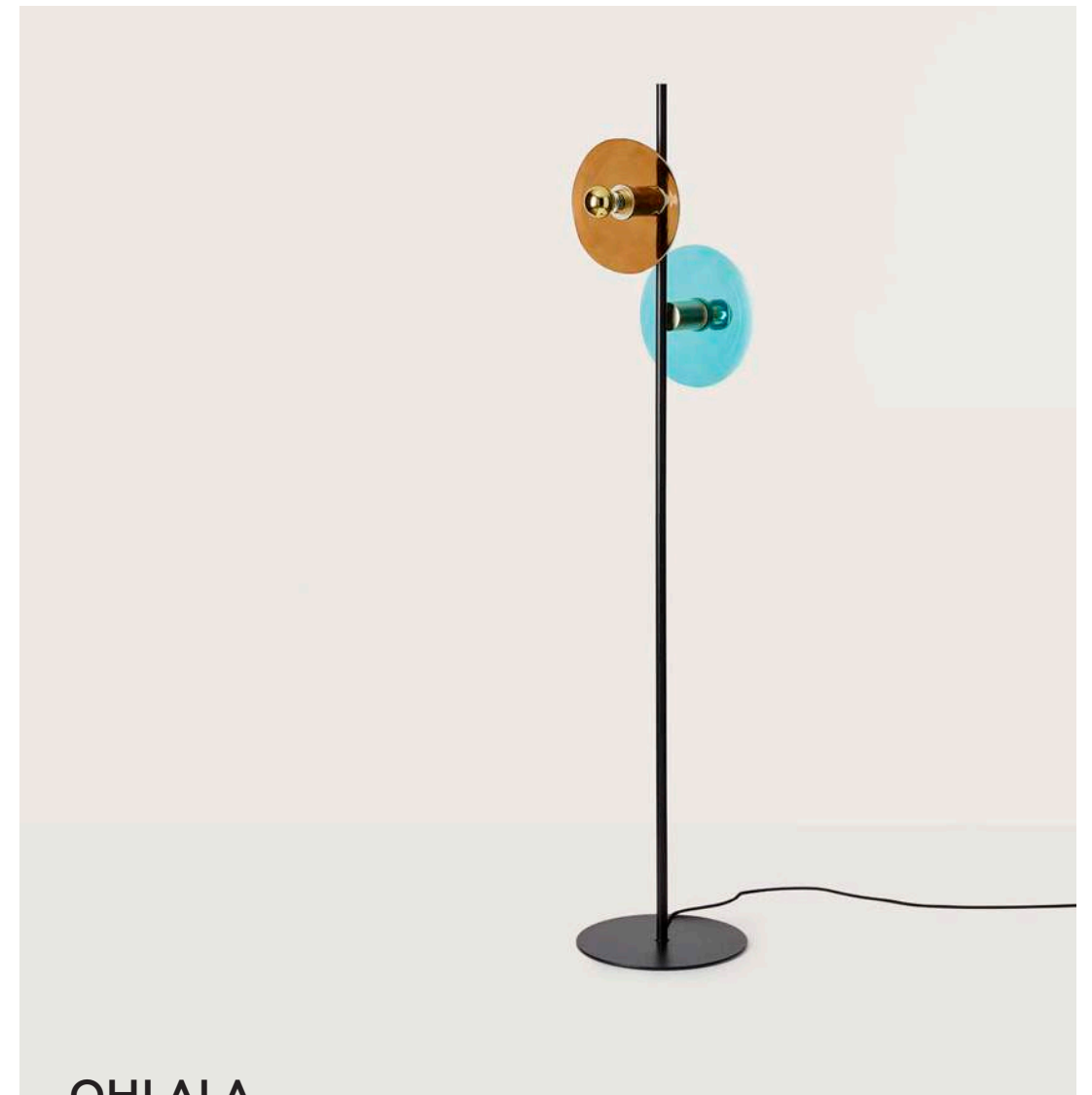
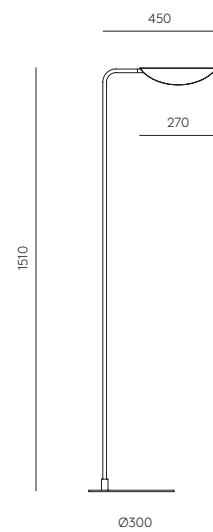

OHLALA

DESIGNED BY AC STUDIO, 2018 · P1242

ES

ACABADOS

Metal: Negro Mate
Portalámparas: Oro
Blanco Mate Oro

MATERIALES
Acero

ESPECIFICACIONES (UE)

2 x E27 Max. 60W (No incluida)
220-240 V, 50/60 Hz
IP20, Clase II



CLASIFICACIÓN ENERGÉTICA
A ++

ACCESORIOS

Accesorio imagen 1223
(turquesa, rosa, ámbar y azul oscuro)
Bombilla imagen B038/ORO
(No incluidos)
Más opciones en pág. 362

EN

FINISHES

Metal: Matt Black
Lampholders: Matt Brass
Matt White Matt Brass

MATERIALS
Steel

SPECIFICATIONS (UE)

2 x E27 Max. 60W (Not included)
220-240 V, 50/60 Hz
IP20, Class II



ENERGY LABEL
A ++

ACCESSORIES

Image reference accessory 1223
(turquoise, pink, amber & dark blue)
Image reference bulb B038/GOLD
(Not included)
More options accessory page 362

TEC

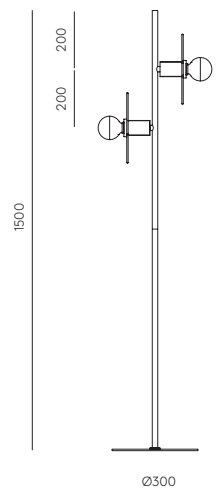





LUCA

DESIGNED BY AC STUDIO, 2017 · P1237

ES

ACABADOS
Metal: Negro Mate Mármol: Blanco

MATERIALES
Acero / Mármol

ESPECIFICACIONES (UE)
E27 Max. 60W (No incluida)
220-240 V, 50/60 Hz
IP20, Clase II



CLASIFICACIÓN ENERGÉTICA
A ++

BOMBILLA RECOMENDADA
B211 (7, 9, 11W)

EN

FINISHES
Metal: Matt Black Marble: White

MATERIALS
Steel / Marble

SPECIFICATIONS (UE)
E27 Max. 60W (Not included)
220-240 V, 50/60 Hz
IP20, Class II



ENERGY LABEL
A ++

RECOMMENDED BULB
B211 (7, 9, 11W)

TEC

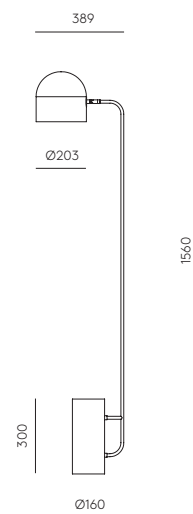

ARIO

DESIGNED BY AC STUDIO, 2017 · P1234

ES

ACABADOS
Metal: Negro Mate Pantalla: Negra

MATERIALES
Acero / Pantalla Algodón

ESPECIFICACIONES (UE)
E27 Max. 60W
(No incluida)
220-240 V, 50/60 Hz
IP20, Clase II



CLASIFICACIÓN ENERGÉTICA
A ++

PANTALLA INCLUIDA

BOMBILLA RECOMENDADA
B211 (7, 9, 11W)

EN

FINISHES
Metal: Matt Black Shade: Black

MATERIALS
Steel / Cotton Shade

SPECIFICATIONS (UE)
E27 Max. 60W
(Not included)
220-240 V, 50/60 Hz
IP20, Class II

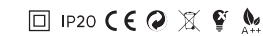

ENERGY LABEL
A ++

SHADE INCLUDED

RECOMMENDED BULB
B211 (7, 9, 11W)

TEC

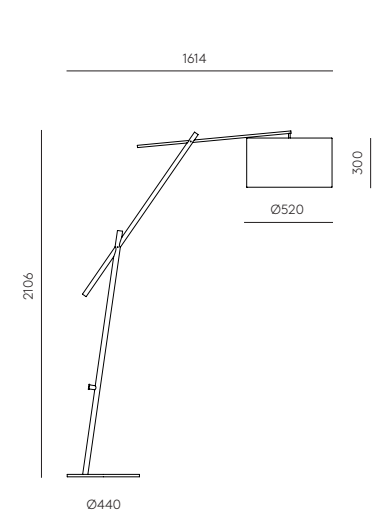



NERA

DESIGNED BY PEPE FORNAS , 2020 · P1229

ES

ACABADOS

Metal: Negro Mate Madera: Negro Mate

MATERIALES

Acero / Madera / Acrílico

ESPECIFICACIONES (UE)

COB LED integrado
8W 3000K (Incluida)
220-240 V, 50/60 Hz
Touch me - Regulable



CLASIFICACIÓN ENERGÉTICA

A ++

EN

FINISHES

Metal: Matt Black Wood: Matt Black

MATERIALS

Steel / Wood / Acrylic

SPECIFICATIONS (UE)

LED COB integrated
8W 3000K (Included)
220-240 V, 50/60 Hz
Touch me - Dimmable



ENERGY LABEL

A ++

TEC

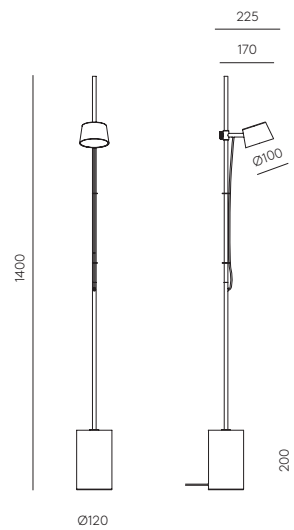



ATOM

DESIGNED BY AC STUDIO, 2016 · P1214

ES

ACABADOS

Metal:
Oro Mate
Negro Mate

Cristal (Incluido):
Opal/Transparente
Opal/Transparente

MATERIALES

Acero / Vidrio Soplado

ESPECIFICACIONES (UE)

Bombilla G9 (Incluida)
5W - 2700K
220-240 V, 50/60 Hz
IP20, Clase II



CLASIFICACIÓN ENERGÉTICA
A ++

BOMBILLAS INCLUIDAS
B005/5W

EN

FINISHES

Metal:
Matt Brass
Matt Black

Shade (Included):
Opal/Clear
Opal/Clear

MATERIALS

Steel / Blown Glass

SPECIFICATIONS (UE)

Bulb G9 (Included)
5W - 2700K
220-240 V, 50/60 Hz
IP20, Class II



ENERGY LABEL
A ++

BULBS INCLUDED
B005/5W

TEC

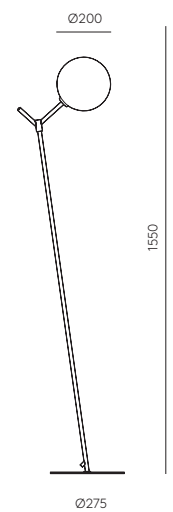





COHEN/COHEN GOLD

DESIGNED BY JANA CHANG, 2010 · P1122 / P1196

ES

ACABADOS
COHEN - P1122
 Metal: Cromo
 Tulipa: Negro, Blanco Brillo
COHEN GOLD - P1196
 Metal: Oro Mate
 Tulipa: Negro, Blanco Brillo

MATERIALES
 Acero

ESPECIFICACIONES (UE)
 E27 Max. 60W (No incluida)
 220-240 V, 50/60 Hz
 IP20, Clase II



CLASIFICACIÓN ENERGÉTICA
 A ++

BOMBILLA RECOMENDADA
 B211 (7, 9, 11W)

EN

FINISHES
COHEN - P1122
 Metal: Chrome
 Shade: Black, Shiny White
COHEN GOLD - P1196
 Metal: Matt Brass
 Shade: Black, Shiny White

MATERIALS
 Steel

SPECIFICATIONS (UE)
 E27 Max. 60W (Not included)
 220-240 V, 50/60 Hz
 IP20, Class II



ENERGY LABEL
 A ++

RECOMMENDED BULB
 B211 (7, 9, 11W)

TEC

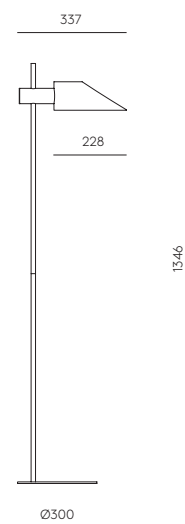

MARU

DESIGNED BY JF SEVILLA, 2015 · P1194

ES

ACABADOS
Metal:
 Negro Mate - Oro Mate
 Negro Mate - Negro Mate

MATERIALES
 Acero

ESPECIFICACIONES (UE)
 Chip Led integrado
 3W - 3150K
 12 V, 50/60 Hz
 IP20, Clase II



CLASIFICACIÓN ENERGÉTICA
 A ++

EN

FINISHES
Metal:
 Matt Black - Matt Brass
 Matt Black - Matt Black

MATERIALS
 Steel

SPECIFICATIONS (UE)
 Integrated Chip Led
 3W - 3150K
 12 V, 50/60 Hz
 IP20, Class II



ENERGY LABEL
 A ++

TEC

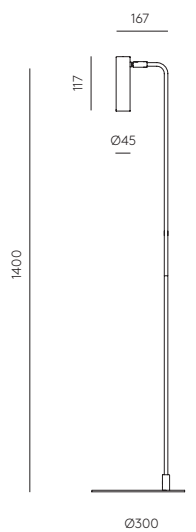



LUA/BOA

DESIGNED BY FORNASEVI, 2015 · P1147 / P1193

ES

ACABADOS
LUA - P1147
 Metal: Cromo
 Tulipa: Rojo, Negro, Blanco Brillo

BOA - P1193
 Metal: Negro Mate
 Tulipa: Negro, Oro Mate

MATERIALES
 Acero

ESPECIFICACIONES (UE)
 E27 Max. 60W (No incluida)
 220-240 V, 50/60 Hz
 IP20, Clase II

CLASIFICACIÓN ENERGÉTICA
 A ++

BOMBILLA RECOMENDADA
 B211 (7, 9, 11W)

EN

FINISHES
LUA - P1147
 Metal: Chrome
 Shade: Red, Black, Shiny White

BOA - P1193
 Metal: Matt Black
 Shade: Black, Matt Brass

MATERIALS
 Steel

SPECIFICATIONS (UE)
 E27 Max. 60W (Not included)
 220-240 V, 50/60 Hz
 IP20, Class II

ENERGY LABEL
 A ++

RECOMMENDED BULB
 B211 (7, 9, 11W)

TEC

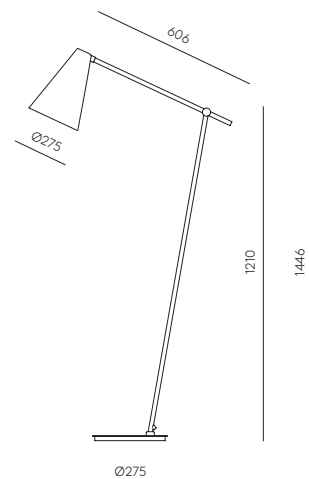

TRIPOD II

DESIGNED BY ESTUDIO COSÍ, 2014 · P1184

ES

ACABADOS
Metal: Cromo
Pantalla: Blanca

MATERIALES
 Acero / Pantalla Algodón

ESPECIFICACIONES (UE)
 E27 Max. 60W (No incluida)
 220-240 V, 50/60 Hz
 IP20, Clase II



CLASIFICACIÓN ENERGÉTICA
 A ++

PANTALLA INCLUIDA

BOMBILLA RECOMENDADA
 B211 (7, 9, 11W)

EN

FINISHES
Metal: Chrome
Shade: White

MATERIALS
 Steel / Cotton Shade

SPECIFICATIONS (UE)
 E27 Max. 60W (Not included)
 220-240 V, 50/60 Hz
 IP20, Class II



ENERGY LABEL
 A ++

SHADE INCLUDED

RECOMMENDED BULB
 B211 (7, 9, 11W)

TEC

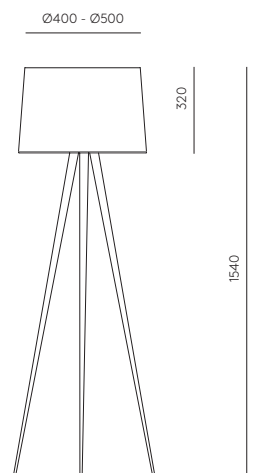



DODO

DESIGNED BY JANA CHANG, 2013 · P1169

ES

ACABADOS
Metal:
 Negro Mate
 Blanco Mate

MATERIALES
 Acero

ESPECIFICACIONES (UE)
 E27 Max. 60W
 (No incluida)
 220-240 V, 50/60 Hz
 IP20, Clase II



CLASIFICACIÓN ENERGÉTICA
 A ++

BOMBILLA RECOMENDADA
 B211 (7, 9, 11W)

EN

FINISHES
Metal:
 Matt Black
 Matt White

MATERIALS
 Steel

SPECIFICATIONS (UE)
 E27 Max. 60W
 (Not included)
 220-240 V, 50/60 Hz
 IP20, Class II



ENERGY LABEL
 A ++

RECOMMENDED BULB
 B211 (7, 9, 11W)

TEC

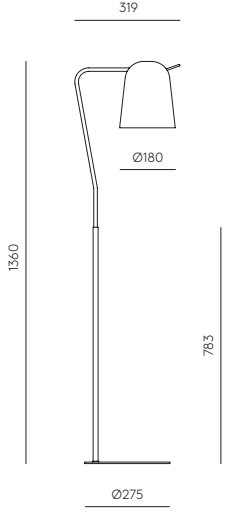



ENDO

DESIGNED BY PEPE FORNAS, 2013 · P1156

ES

ACABADOS

Metal:
Oro Mate
Cromo

Cristal (Incluido):
Opal
Opal

MATERIALES

Acero / Vidrio Soplado

ESPECIFICACIONES (UE)

Bombilla G9 Led - 5W (Incluida)
2700K
220-240 V, 50/60 Hz
IP20, Clase II



CLASIFICACIÓN ENERGÉTICA

A ++

BOMBILLA INCLUIDA

B005/5W

EN

FINISHES

Metal:
Matt Brass
Chrome

Glass Shade (Included):
Opal
Opal

MATERIALS

Steel / Blown Glass

SPECIFICATIONS (UE)

Bulb G9 Led - 5W (Included)
2700K
220-240 V, 50/60 Hz
IP20, Class II



ENERGY LABEL

A ++

BULB INCLUDED

B005/5W

TEC

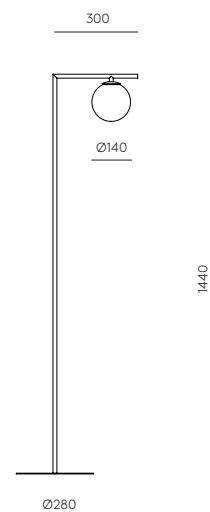



RIU

DESIGNED BY JF SEVILLA, 2012 · P1140

ES

ACABADOS

Metal: Negro Mate Negro Haya
Blanco Mate Blanco Haya

Pantalla: Negro Haya
Blanco Haya

Madera: Haya
Haya

MATERIALES

Acero / Madera / Textil

ESPECIFICACIONES (UE)

E27 Max. 60W (No incluida)
220-240 V, 50/60 Hz
IP20, Clase II



CLASIFICACIÓN ENERGÉTICA

A ++

BOMBILLA RECOMENDADA

B211 (7, 9, 11W)

EN

FINISHES

Metal: Matt Black Black
Matt White White

Shade: Black
White

Wood: Beech
Beech

MATERIALS

Steel / Wood / Fabric

SPECIFICATIONS (UE)

E27 Max. 60W (Not included)
220-240 V, 50/60 Hz
IP20, Class II



ENERGY LABEL

A ++

RECOMMENDED BULB

B211 (7, 9, 11W)

TEC

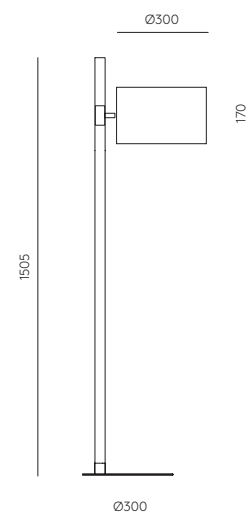

PAGO

DESIGNED BY PEPE FORNAS, 2010 · P1126

ES

ACABADOS

Metal: Blanco Brillo - Cromo
Negro Brillo - Oro Brillo
Negro Brillo - Cromo

MATERIALES

Acero

ESPECIFICACIONES (UE)

GU10 Max. 50W (No incluida)
220-240 V, 50/60 Hz
IP20, Clase II



CLASIFICACIÓN ENERGÉTICA

A ++

BOMBILLA RECOMENDADA

B161 (5W)

EN

FINISHES

Metal: Shiny White - Chrome
Shiny Black - Shiny Gold
Shiny Black - Chrome

MATERIALS

Steel

SPECIFICATIONS (UE)

GU10 Max. 50W (Not included)
220-240 V, 50/60 Hz
IP20, Class II



ENERGY LABEL

A ++

RECOMMENDED BULB

B161 (5W)

TEC

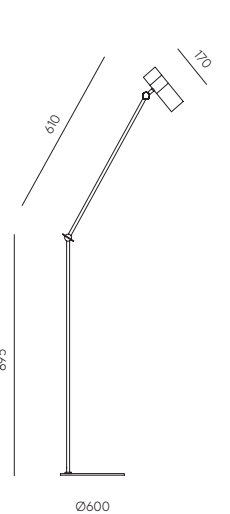



ONA

DESIGNED BY JI BALLESTER, 2008 · P1029

ES

ACABADOS

Metal:
Níquel Satinado
Níquel Satinado

Textil:
Negro
Blanco

MATERIALES

Acero / Pantalla Textil Lisa

ESPECIFICACIONES (UE)

E27 - 2 x Max. 40W (No incluida)
220-240 V, 50/60 Hz
IP20, Clase II



CLASIFICACIÓN ENERGÉTICA

A ++

BOMBILLA RECOMENDADA

B211 (7, 9, 11W)

EN

FINISHES

Metal:
Satin Nickel
Satin Nickel

Shade:
Black
White

MATERIALS

Steel / Smooth Fabric Shade

SPECIFICATIONS (UE)

E27 - 2 x Max. 40W (Not included)
220-240 V, 50/60 Hz
IP20, Class II



ENERGY LABEL

A ++

RECOMMENDED BULB

B211 (7, 9, 11W)

TEC

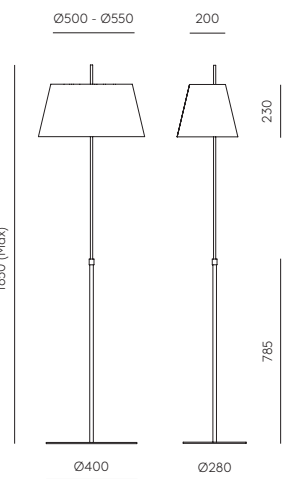



TEX

DESIGNED BY AC STUDIO, 2012 · P1026

ES

ACABADOS

Metal:
Blanco Mate
Negro Mate

MATERIALES

Acero

ESPECIFICACIONES (UE)

E27 Max. 60W (No incluida)
220-240 V, 50/60 Hz
IP20, Clase II



CLASIFICACIÓN ENERGÉTICA

A ++

PANTALLA IMAGEN 151011/40

PANTALLA NO INCLUIDA

BOMBILLA RECOMENDADA

B211 (7, 9, 11W)

EN

FINISHES

Metal:
Matt White
Matt Black

MATERIALS

Steel

SPECIFICATIONS (UE)

E27 Max. 60W (Not included)
220-240 V, 50/60 Hz
IP20, Class II



ENERGY LABEL

A ++

IMAGE REFERENCE SHADE 151011/40

SHADE NOT INCLUDED

RECOMMENDED BULB

B211 (7, 9, 11W)

TEC

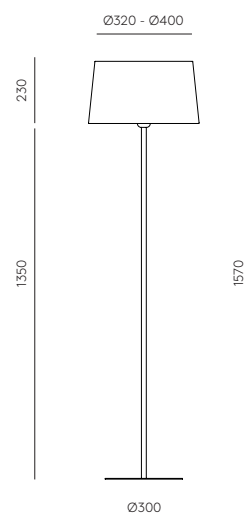

TRIP

DESIGNED BY AC STUDIO, 2008 · P1020

ES

ACABADOS

Madera:
Haya

MATERIALES

Madera

ESPECIFICACIONES (UE)

E27 Max. 60W (No incluida)
220-240 V, 50/60 Hz
IP20, Clase II



CLASIFICACIÓN ENERGÉTICA

A ++

PANTALLA IMAGEN 031021/55

PANTALLA NO INCLUIDA

BOMBILLA RECOMENDADA

B211 (7, 9, 11W)

EN

FINISHES

Wood:
Beech

MATERIALS

Wood

SPECIFICATIONS (UE)

E27 Max. 60W (Not included)
220-240 V, 50/60 Hz
IP20, Class II



ENERGY LABEL

A ++

IMAGE REFERENCE SHADE 031021/55

SHADE NOT INCLUDED

RECOMMENDED BULB

B211 (7, 9, 11W)

TEC

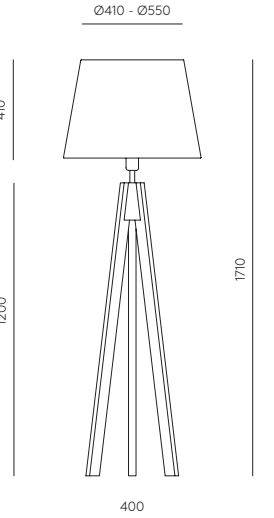

Wall lamps

270	MIRO	304	DELIE L	336	LAOS
272	FITO	306	DELIE	337	OSION
273	AMBOR	307	FEST	338	PAGO
274	ATIL	308	HELMET	339	TAN TAN
275	DALT	309	LIND	342	COHEN
278	FOCUS	310	HELMET CURVE	343	GLOP
280	LYB	311	RAIN	344	FIND
281	CLOCK	312	ATOM	345	EHY
282	BOT	314	LAN	348	READ
283	ALMON	316	PIN	349	CROPI
284	ABBY	317	DOBI	350	MINI LAITO
285	ABBY	318	COSS	352	KASSY
286	ABBACUS	319	MARU	353	ALBA
288	ERTO	322	SNOW FLAKE	354	VASTER
291	SUAL	323	LOTTO	355	LAIN
292	FLEXI LEATHER	324	ROSS	356	MINIROSS
293	MAHO	326	XTRA	357	HABAN
296	FICUS	327	LESS	360	WHEEL
298	LUCA	328	SPIDER	361	HEDULA
299	LAITO	330	VENT		
300	LITA	331	FLEXOR		
301	NERA	332	PILD		
302	ALOA	333	CAMB		



MIRO

DESIGNED BY AC STUDIO, 2021 · A1289

ES

ACABADOS
Metal: Negro Mate **Tulipa:** Opal

MATERIALES
 Acero / Vidrio Soplado

ESPECIFICACIONES (UE)
 G9 LED (incluida) 5W 2700K
 220-240V, 50/60 Hz
 IP20, Clase I

IP20

CLASIFICACIÓN ENERGÉTICA
 A ++

BOMBILLAS RECOMENDADA
 B005 / 5W

ACCESORIOS COMPATIBLES (NO INCLUIDOS)
 Alabastro 1096 (20 cm)
 Cerámica (20 cm)
 Disco Metálico 1038 (15 cm)

EN

FINISHES
Metal: Matt Black **Shade:** Opal

MATERIALS
 Steel / Blown Glass

SPECIFICATIONS (UE)
 G9 LED (included) 5W 2700K
 220-240V, 50/60 Hz
 IP20, Class I

IP20

ENERGY LABEL
 A ++

RECOMMENDED BULB
 B005 / 5W

COMPATIBLE ACCESSORIES (NOT INCLUDED)
 Alabaster 1096 (20 cm)
 Ceramic (20 cm)
 Metallic disc 1038 (15 cm)

TEC

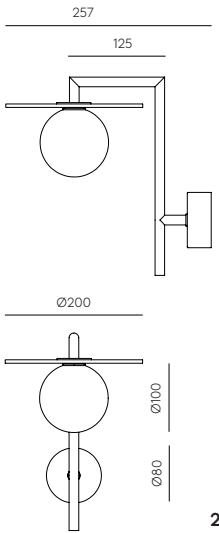



FITO

DESIGNED BY PEPE FORNAS, 2020 · A1286

ES

ACABADOS
Metal:
Negro Mate

Rejilla:
Oro Mate

MATERIALES
Acero

ESPECIFICACIONES (UE)
T8 Led 14W (Incluido)
3000K
220-240 V, 50/60 Hz
IP20, Clase I

IP20    

CLASIFICACIÓN ENERGÉTICA
A ++

BOMBILLAS INCLUIDAS
T8 / 14W

EN

FINISHES
Metal:
Matt Black **Shade:**
Matt Brass

MATERIALS
Steel

SPECIFICATIONS (UE)
T8 Led 14W (Included)
3000K
220-240 V, 50/60 Hz
IP20, Class I

IP20    

ENERGY LABEL
A ++

BULBS INCLUDED
T8 / 14W

TEC

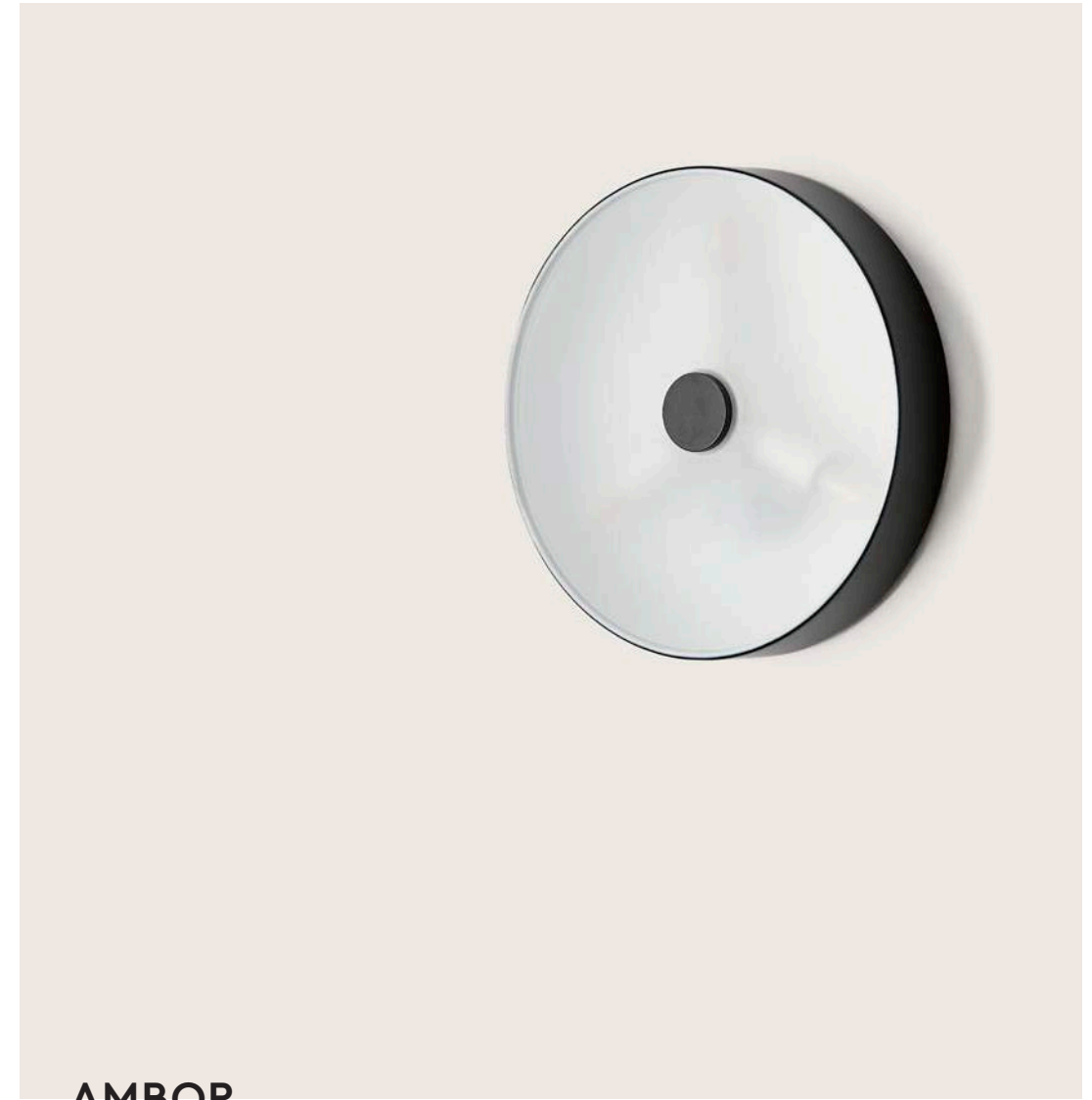
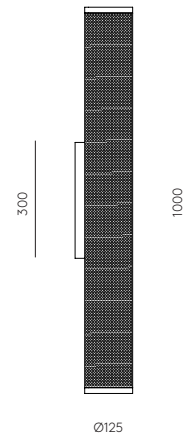

AMBOR

DESIGNED BY PEPE FORNAS, 2019 · A1283

ES

ACABADOS
Metal:
Negro Mate

Difusor:
Opal

MATERIALES
Acero / Acrílico

ESPECIFICACIONES (UE)
Bombillas G9 Led (Incluidas)
3 x 3W - 3000K
220-240 V, 50/60 Hz
IP20, Clase I

IP20    

CLASIFICACIÓN ENERGÉTICA
A ++

BOMBILLAS RECOMENDADA
B005

EN

FINISHES
Metal:
Matt Black

Diffuser:
Opal

MATERIALS
Steel / Acrylic Glass

SPECIFICATIONS (UE)
G9 Led Bulbs (Included)
3 x 3W - 3000K
220-240 V, 50/60 Hz
IP20, Class I

IP20    

ENERGY LABEL
A ++

RECOMMENDED BULB
B005

TEC

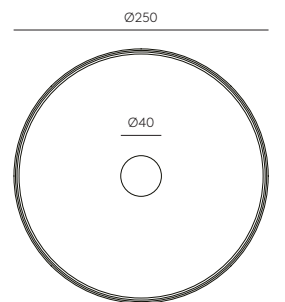



ATIL

DESIGNED BY PEPE FORNAS, 2019 · A1281

ES

ACABADOS
Metal:
Negro Mate
Oro Mate

Tulipa:
Opal
Opal

MATERIALES
Acero / Vidrio

ESPECIFICACIONES (UE)
Bombillas G9 Led (Incluidas)
2 x 5W - 2700K
220-240 V, 50/60 Hz
IP20, Clase I
IP20

CLASIFICACIÓN ENERGÉTICA
A ++

BOMBILLAS INCLUIDAS
B005/5W

EN

FINISHES
Metal:
Matt Black
Matt Brass

Shade:
Opal
Opal

MATERIALS
Steel / Glass

SPECIFICATIONS (UE)
G9 Led Bulbs (Included)
2 x 5W - 2700K
220-240 V, 50/60 Hz
IP20, Class I
IP20

ENERGY LABEL
A ++

BULBS INCLUDED
B005/5W

TEC

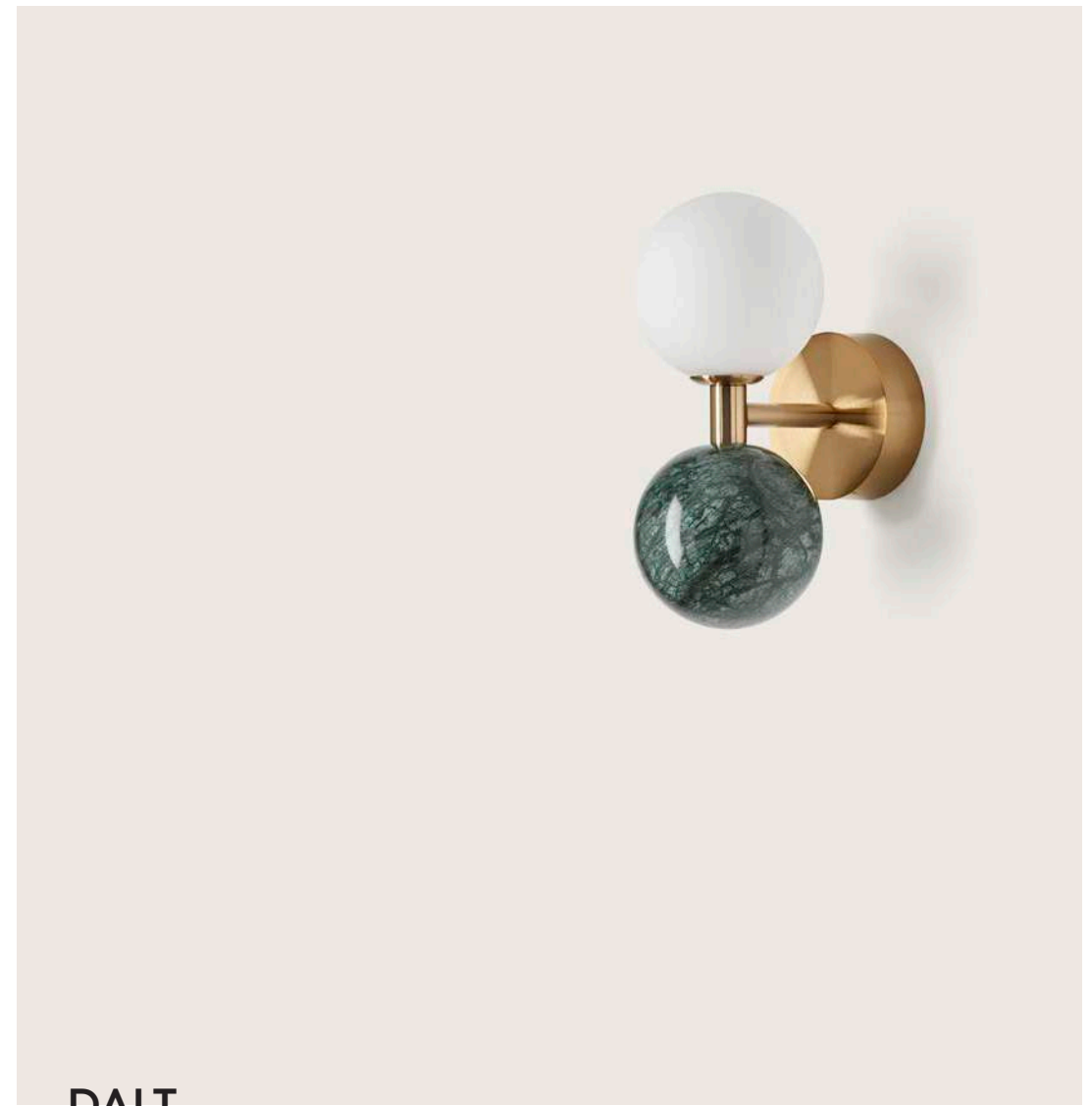
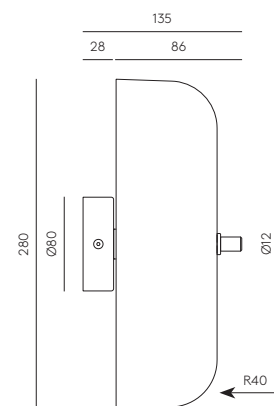

DALT

DESIGNED BY PEPE FORNAS, 2019 · A1280

ES

ACABADOS
Metal:
Negro Mate
Oro Envejecido
Negro Mate

Mármol:
Blanco
Verde
Negro

Tulipa:
Opal
Opal
Opal

MATERIALES
Acero / Mármol / Vidrio

ESPECIFICACIONES (UE)
Bombilla G9 Led (Incluida)
5W - 3000K
220-240 V, 50/60 Hz
IP20, Clase I
IP20

CLASIFICACIÓN ENERGÉTICA
A ++

BOMBILLA RECOMENDADA
B005/5W

EN

FINISHES
Metal:
Matt Black
Aged Gold
Matt Black

Marble:
White
Green
Black

Glass Shade:
Opal
Opal
Opal

MATERIALS
Steel / Marble / Glass

SPECIFICATIONS (UE)
Bulb G9 Led (Included)
5W - 3000K
220-240 V, 50/60 Hz
IP20, Class I
IP20

ENERGY LABEL
A ++

RECOMMENDED BULB
B005/5W

TEC

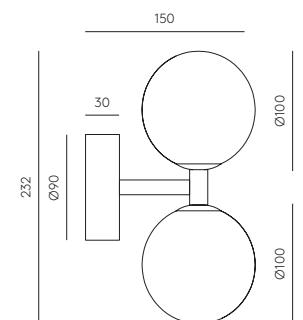





FOCUS

DESIGNED BY PEPE FORNAS, 2019 · A1279

ES

ACABADOS

Cuerpo: Negro Mate
Oro Viejo
Plata Mate

Cabeza: Oro Viejo
Alabastro
Antracita

MATERIALES

Acero / Aluminio o Alabastro

ESPECIFICACIONES (UE)

Bombilla GU10 Led (Incluida)
5W - 3000K
220-240 V, 50/60 Hz
IP20, Clase I

IP20 CE RoHS A++

CLASIFICACIÓN ENERGÉTICA
A ++

MODIFICACIONES POSIBLES
Cabezal Alabastro (Sobrecoste)

BOMBILLA RECOMENDADA
B161

EN

FINISHES

Body: Matt Black
Aged Gold
Matt Silver

Head: Aged Gold
Alabaster
Anthracite

MATERIALS

Steel / Aluminium or Alabaster

SPECIFICATIONS (UE)

Bulb GU10 Led (Included)
5W - 3000K
220-240 V, 50/60 Hz
IP20, Class I

IP20 CE RoHS A++

ENERGY LABEL
A ++

POSSIBLE MODIFICATIONS
Alabaster head (Extra charge)

RECOMMENDED BULB
B161

TEC

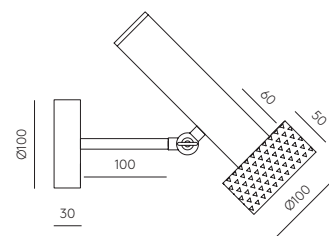



LYB

DESIGNED BY PEPE FORNAS, 2019 · A1274

ES

ACABADOS
Metal:
Negro Mate

MATERIALES
Acero

ESPECIFICACIONES (UE)
Led integrado 5W,
3000K
12 V, 50/60 Hz
IP20, Clase I



CLASIFICACIÓN ENERGÉTICA
A ++

TOUCH ME DIMERABLE

EN

FINISHES
Body:
Matt Black

MATERIALS
Steel

SPECIFICATIONS (UE)
Led integrated 5W,
3000K
12 V, 50/60 Hz
IP20, Class I



ENERGY LABEL
A ++

TOUCH ME DIMMABLE

TEC

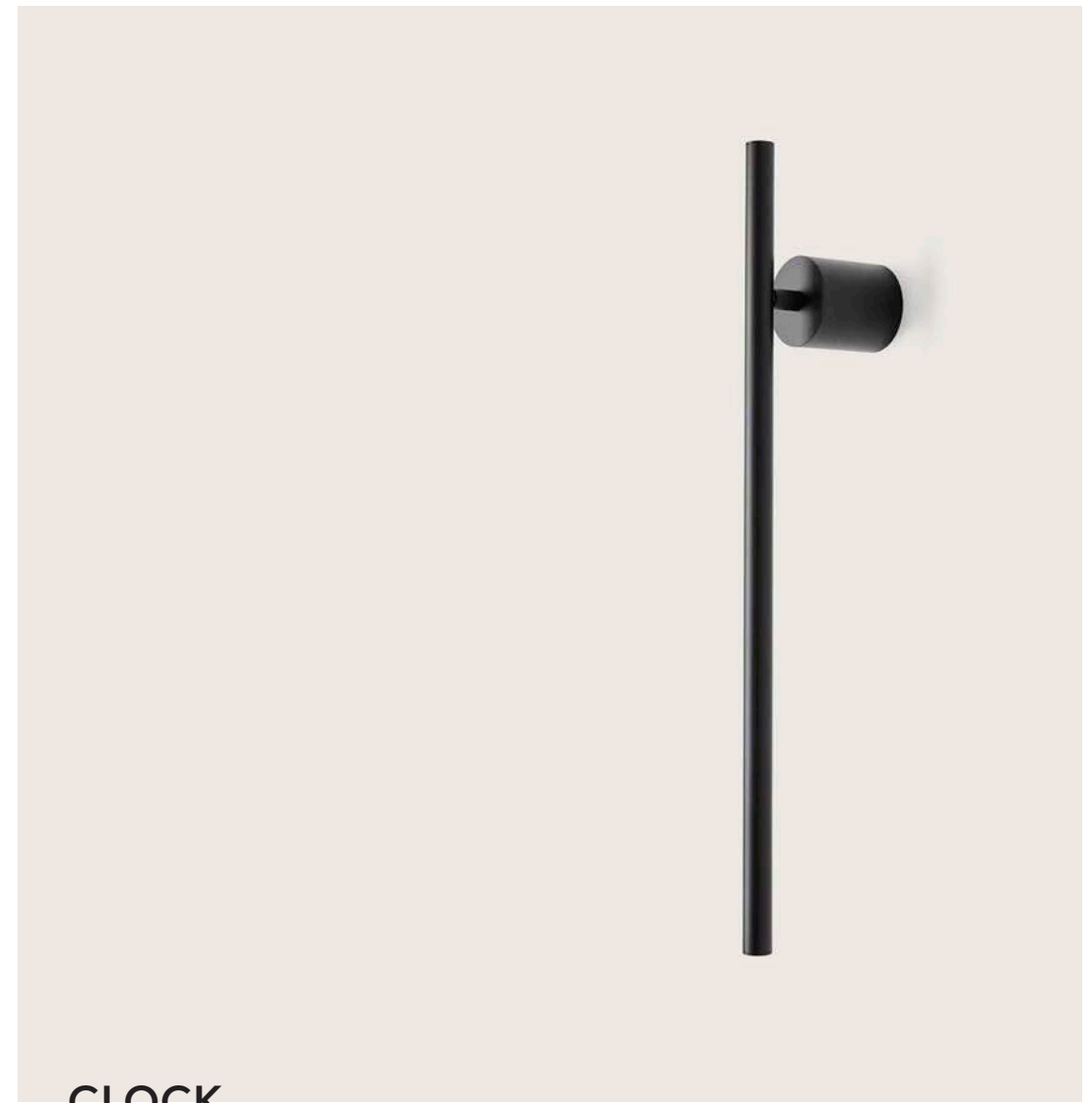
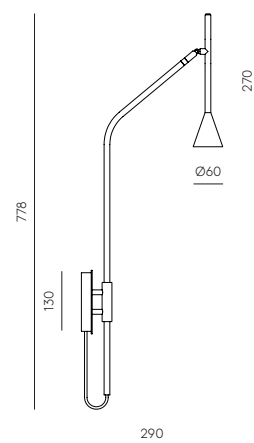

CLOCK

DESIGNED BY AC STUDIO, 2019 · A1273

ES

ACABADOS
Metal:
Negro Mate

MATERIALES
Acero

ESPECIFICACIONES (UE)
Tira Led integrada Regulable
12W - 3000K
12 V, 50/60 Hz
IP20, Clase I



CLASIFICACIÓN ENERGÉTICA
A ++

EN

FINISHES
Metal:
Matt Black

MATERIALS
Steel

SPECIFICATIONS (UE)
Dimmable Strip Led integrated
12W - 3000K
12 V, 50/60 Hz
IP20, Class I



ENERGY LABEL
A ++

TEC

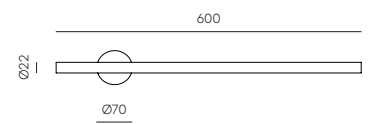

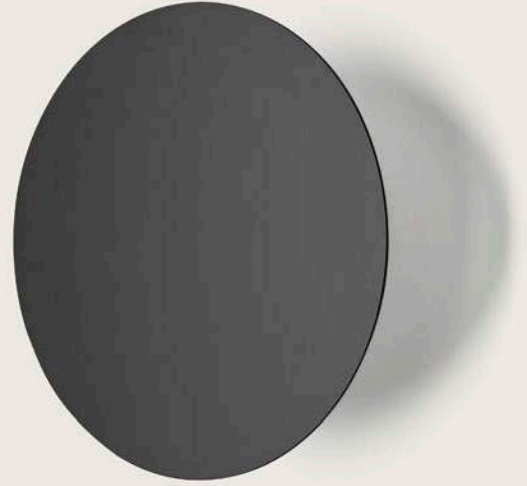

BOT

DESIGNED BY PEPE FORNAS, 2019 · A1272

ES

ACABADOS
Metal:
Negro Mate
Blanco Mate

MATERIALES
Acero

ESPECIFICACIONES (UE)
Led integrado
18W - 3000K
12 V, 50/60 Hz
IP20, Clase I

IP20    

CLASIFICACIÓN ENERGÉTICA
A ++

EN

FINISHES
Body:
Matt Black
Matt White

MATERIALS
Steel

SPECIFICATIONS (UE)
Led integrated
18W - 3000K
12 V, 50/60 Hz
IP20, Class I

IP20    

ENERGY LABEL
A ++

TEC

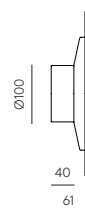
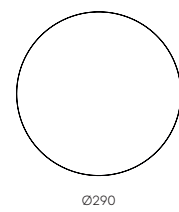

ALMON

DESIGNED BY PEPE FORNAS, 2018 · A1264

ES

ACABADOS
Metal:
Negro Mate
Oro Mate (detalles)
Piel Marrón

MATERIALES
Acero
Vidrio soplado
Cuero

ESPECIFICACIONES (UE)
Bombilla G9 Led (Incluida)
5W - 2700K
220-240 V, 50/60 Hz
IP20, Clase I

IP20    

CLASIFICACIÓN ENERGÉTICA
A ++

BOMBILLA RECOMENDADA
B005/5W

EN

FINISHES
Body:
Matt Black
Matt Brass (details)
Brown Leather

MATERIALS
Steel
Blown Glass
Leather

SPECIFICATIONS (UE)
Bulb G9 Led (Included)
5W - 2700K
220-240 V, 50/60 Hz
IP20, Class I

IP20    

ENERGY LABEL
A ++

RECOMMENDED BULB
B005/5W

TEC

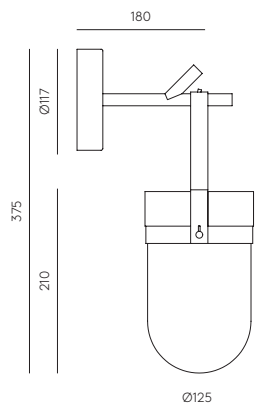



ABBY

DESIGNED BY AC STUDIO, 2018 · A1259

ES

ACABADOS
Metal:
Oro Mate
Bronce

MATERIALES
Acero

ESPECIFICACIONES (UE)
4 x E27 Max. 60W (No incluida)
220-240 V, 50/60 Hz
IP20, Clase I
Estructura articulable

IP20

CLASIFICACIÓN ENERGÉTICA
A ++

MODIFICACIONES POSIBLES
Accesorios disponibles en pág. 362
Accesorio de la foto: 1096/25 disco
de alabastro y 1038/250-350 mm
Bombilla de la foto: B038/ORO
(No incluidos)

EN

FINISHES
Body:
Matt Brass
Bronze

MATERIALS
Steel

SPECIFICATIONS (UE)
4 x E27 Max. 60W (Not included)
220-240 V, 50/60 Hz
IP20, Class I
Articulate structure

IP20

ENERGY LABEL
A ++

POSSIBLE MODIFICATIONS
Accessories available are on page 362
Image Accessories: 1096/25 alabaster
disc and 1038/250-350 mm
Bulb image: B038/GOLD
(Both not included)

TEC

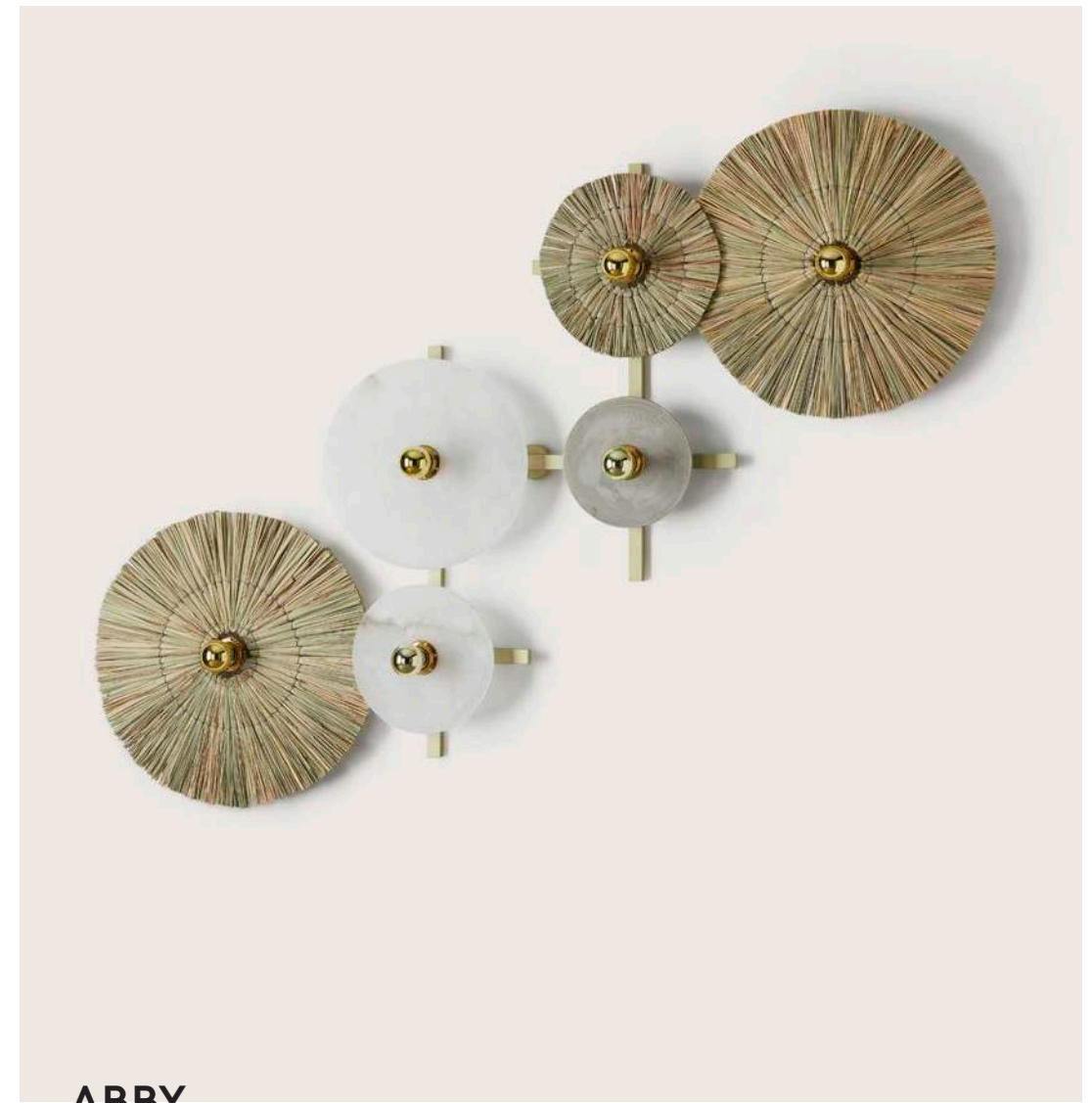
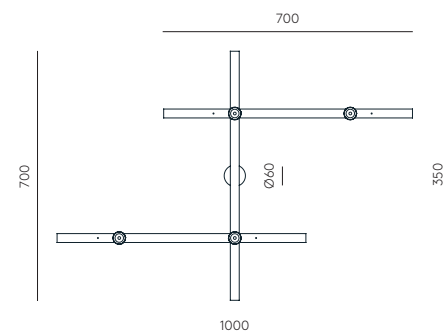

ABBY

DESIGNED BY AC STUDIO, 2018 · A1259/6

ES

ACABADOS
Metal:
Oro Mate
Bronce

MATERIALES
Acero

ESPECIFICACIONES (UE)
6 x E27 Max. 60W (No incluida)
220-240 V, 50/60 Hz
IP20, Clase I
Estructura articulable

IP20

CLASIFICACIÓN ENERGÉTICA
A ++

MODIFICACIONES POSIBLES
Accesorios disponibles en pág. 362
Accesorios imagen (NO incluidos):
Paja - 1141/30 y 1141/50 (2)
Alabastro - 1096/25 y 1096/35
Cerámica - 1097/20

EN

FINISHES
Body:
Matt Brass
Bronze

MATERIALS
Steel

SPECIFICATIONS (UE)
6 x E27 Max. 60W (Not included)
220-240 V, 50/60 Hz
IP20, Class I
Estructura articulable

IP20

ENERGY LABEL
A ++

POSSIBLE MODIFICATIONS
Accessories available are on page 362
Image accessories (NOT included):
Straw - 1141/30 and 1141/50 (2)
Alabaster - 1096/25 and 1096/35
Ceramic - 1097/20

TEC

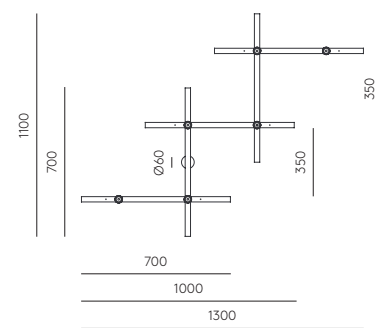



ABBACUS

DESIGNED BY PEPE FORNAS, 2018 · A1258

ES

ACABADOS

Metal:
Negro Mate
Oro Mate

Cristal (Incluido):
Opal/Transparente
Opal/Transparente

MATERIALES

Acero / Vidrio Soplado

ESPECIFICACIONES (UE)

Bombilla G9 (Incluida)
5W - 2700K
220-240 V, 50/60 Hz
IP20, Clase I



CLASIFICACIÓN ENERGÉTICA

A ++

BOMBILLA INCLUIDA

B005/5W

EN

FINISHES

Metal:
Matt Black
Matt Brass

Glass Shade (Included):
Opal/Clear
Opal/Clear

MATERIALS

Steel / Iown Glass

SPECIFICATIONS (UE)

Bulb G9 (Included)
5W - 2700K
220-240 V, 50/60 Hz
IP20, Class I



ENERGY LABEL

A ++

BULB INCLUDED

B005/5W

TEC

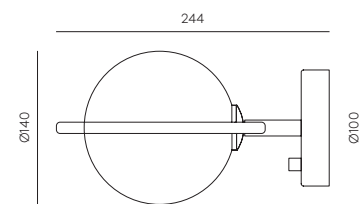

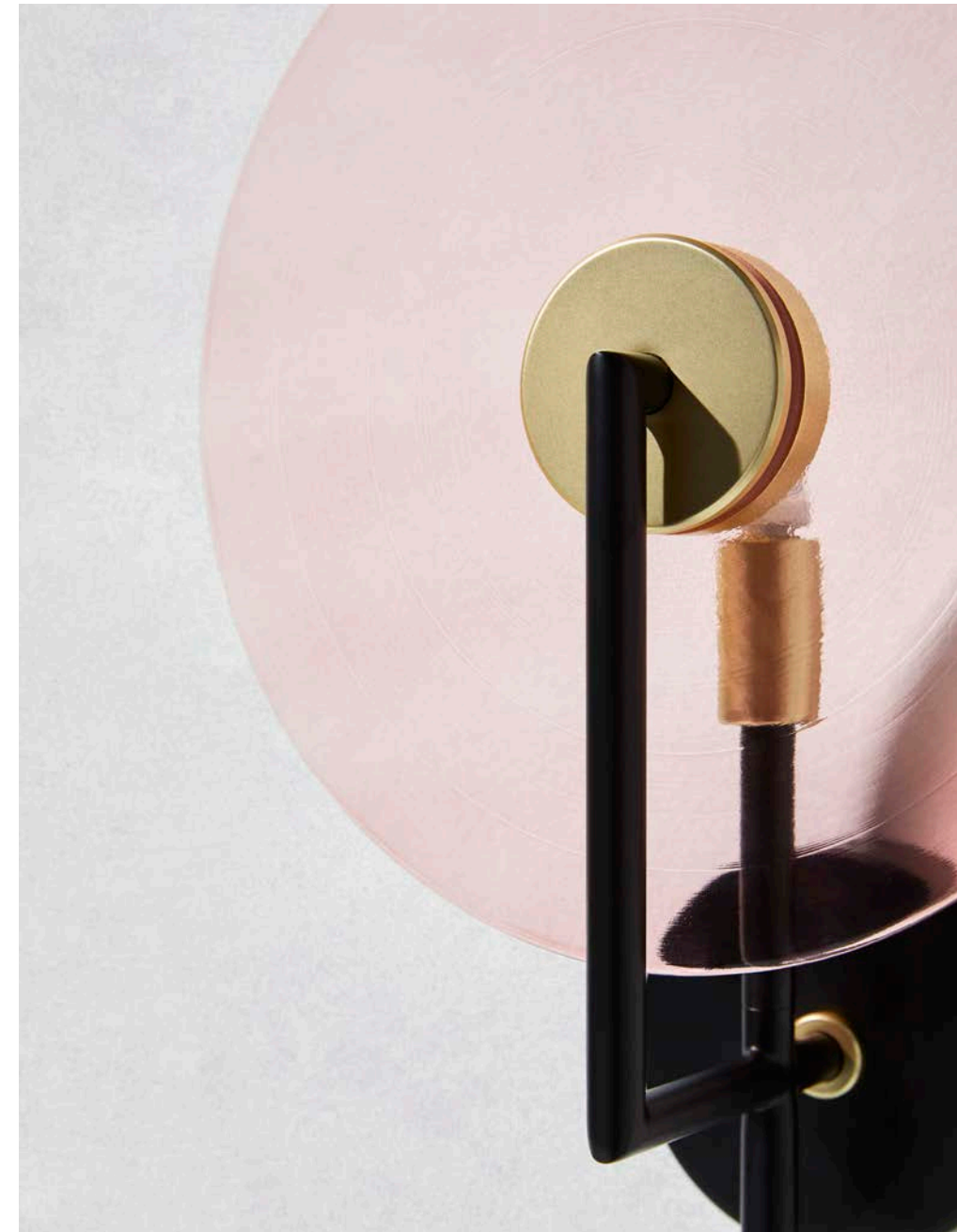
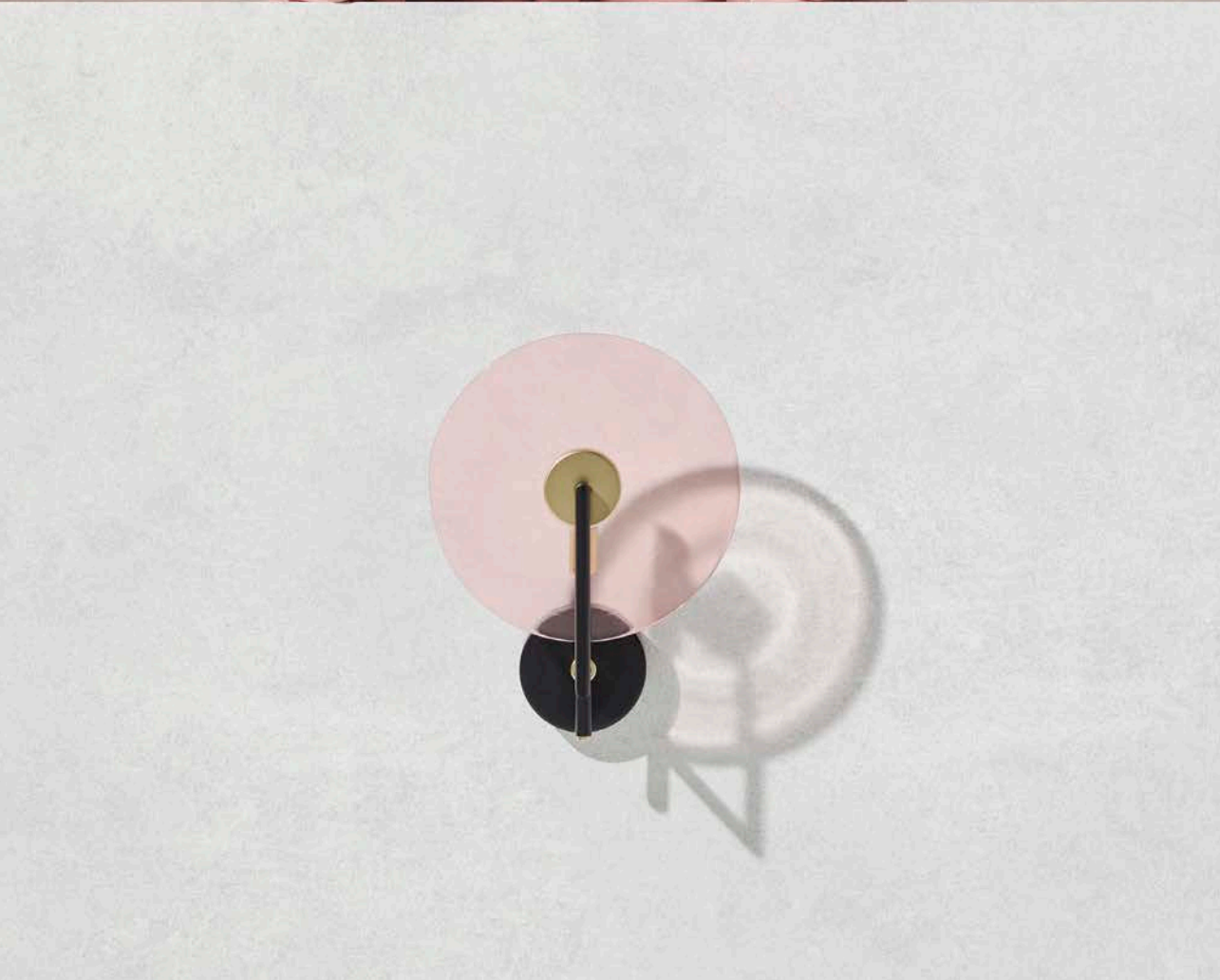



ERTO

DESIGNED BY AC STUDIO, 2020 · A1257

ES

ACABADOS

Metal:
Negro Mate
Oro Mate (detalles)

MATERIALES

Acero

ESPECIFICACIONES (UE)

G9 LED (Incluida)
5W - 2700K
220-240 V, 50/60 Hz
IP20, Clase I



CLASIFICACIÓN ENERGÉTICA

A ++

ACCESORIO IMAGEN (NO INCLUIDO)

1097/20 - Disco Cerámica
Otras opciones 355-356

BOMBILLA INCLUIDA

B005/5W

EN

FINISHES

Metal:
Matt Black
Matt Brass

MATERIALS

Steel

SPECIFICATIONS (UE)

G9 LED (Included)
5W - 2700K
220-240 V, 50/60 Hz
IP20, Class I



ENERGY LABEL

A ++

IMAGE ACCESSORY (NOT INCLUDED)

1097/20 - Ceramic Disc
Other options 355-356

BULB INCLUDED

B005/5W

TEC

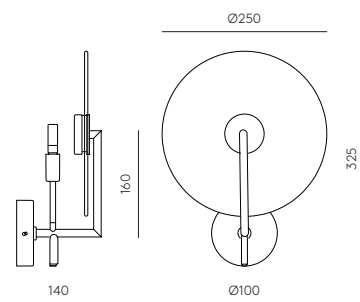

SUAL

DESIGNED BY FORNASEVI, 2020 · A1255

ES

ACABADOS

Metal:
Negro Mate

MATERIALES

Acero / Acrílico

ESPECIFICACIONES (UE)

Placa LED integrada 9W 3000K (Incluida) 24V / 220-240 V, 50/60 Hz
IP20, Clase I



CLASIFICACIÓN ENERGÉTICA

A ++

ACCESORIOS COMPATIBLES (NO INCL.)

Alabastro - 1096/25
Alabastro - 1096/35
Cerámica - 1097/20
Cerámica - 1097/30
Metal rayado - 1089/25
Cristal - 1223
Metal - 1038/25

EN

FINISHES

Metal:
Matt Black

MATERIALS

Steel / Iown Glass

SPECIFICATIONS (UE)

Integrated LED plate 9W 3000K (Included) 24V / 220-240 V, 50/60 Hz
IP20, Class I



ENERGY LABEL

A ++

COMPATIBLE ACCESSORIES (NOT INCL.)

Alabaster - 1096/25
Alabaster - 1096/35
Ceramic - 1097/20
Ceramic - 1097/30
Stripped Metal - 1089/25
Glass - 1223
Metal - 1038/25

TEC

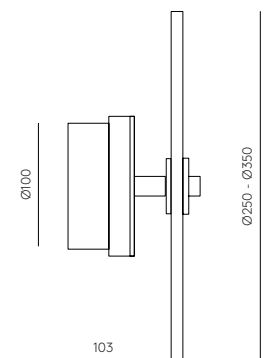



FLEXI LEATHER

DESIGNED BY AC STUDIO, 2018 · A1248/47

ES

ACABADOS

Metal A1248:
Oro Mate

Piel:
Piel Oscura

Metal A1247:
Bronce

Piel:
Piel Clara

MATERIALES

Acero / Piel

ESPECIFICACIONES (UE)

Led integrado
3W - 3000K
12 V, 50/60 Hz
IP20, Clase I



CLASIFICACIÓN ENERGÉTICA
A ++

EN

FINISHES

Metal A1248:
Matt Brass

Leather:
Dark Brown

Metal A1247:
Bronze

Leather:
Light Brown

MATERIALS

Steel / Leather

SPECIFICATIONS (UE)

Led integrated
3W - 3000K
12 V, 50/60 Hz
IP20, Class I



ENERGY LABEL
A ++

TEC

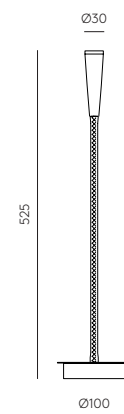

MAHO

DESIGNED BY JF SEVILLA, 2020 · A1254

ES

ACABADOS

Cabeza:
Negro Mate
Oro Mate

Cuerpo:
Negro Mate
Negro Mate

MATERIALES

Acero

ESPECIFICACIONES (UE)

LED COB integrado 5W 3000K (Incluido)
220-240 V, 50/60 Hz
Touch Me - Regulable
IP20, Clase I



CLASIFICACIÓN ENERGÉTICA
A ++

EN

FINISHES

Head:
Matt Black
Matt Brass

Body:
Matt Black
Matt Black

MATERIALS

Steel

SPECIFICATIONS (UE)

Integrated COB LED 5W 3000K (Included)
220-240 V, 50/60 Hz
Touch Me - Dimmable
IP20, Class I



ENERGY LABEL
A ++

TEC

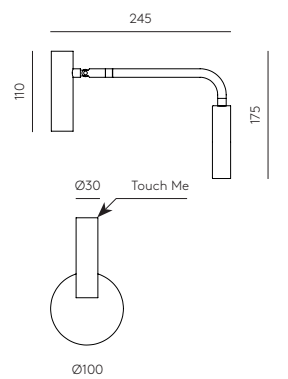





FICUS

DESIGNED BY JF SEVILLA, 2017 · A1243

ES

ACABADOS

Metal: Oro Mate
Tulipa: Negro Mate

MATERIALES
Acero

ESPECIFICACIONES (UE)

G9 (Incluida)
5W - 2700K
220-240 V, 50/60 Hz
IP20, Clase I



CLASIFICACIÓN ENERGÉTICA
A ++

BOMBILLA RECOMENDADA
B005/5W

EN

FINISHES

Metal: Matt Black
Shade: Matt Black

MATERIALS
Steel

SPECIFICATIONS (UE)

G9 (Included)
5W - 2700K
220-240 V, 50/60 Hz
IP20, Class I



ENERGY LABEL
A ++

RECOMMENDED BULB
B005/5W

TEC

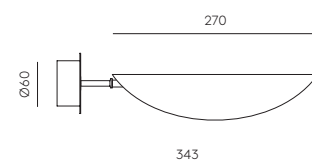

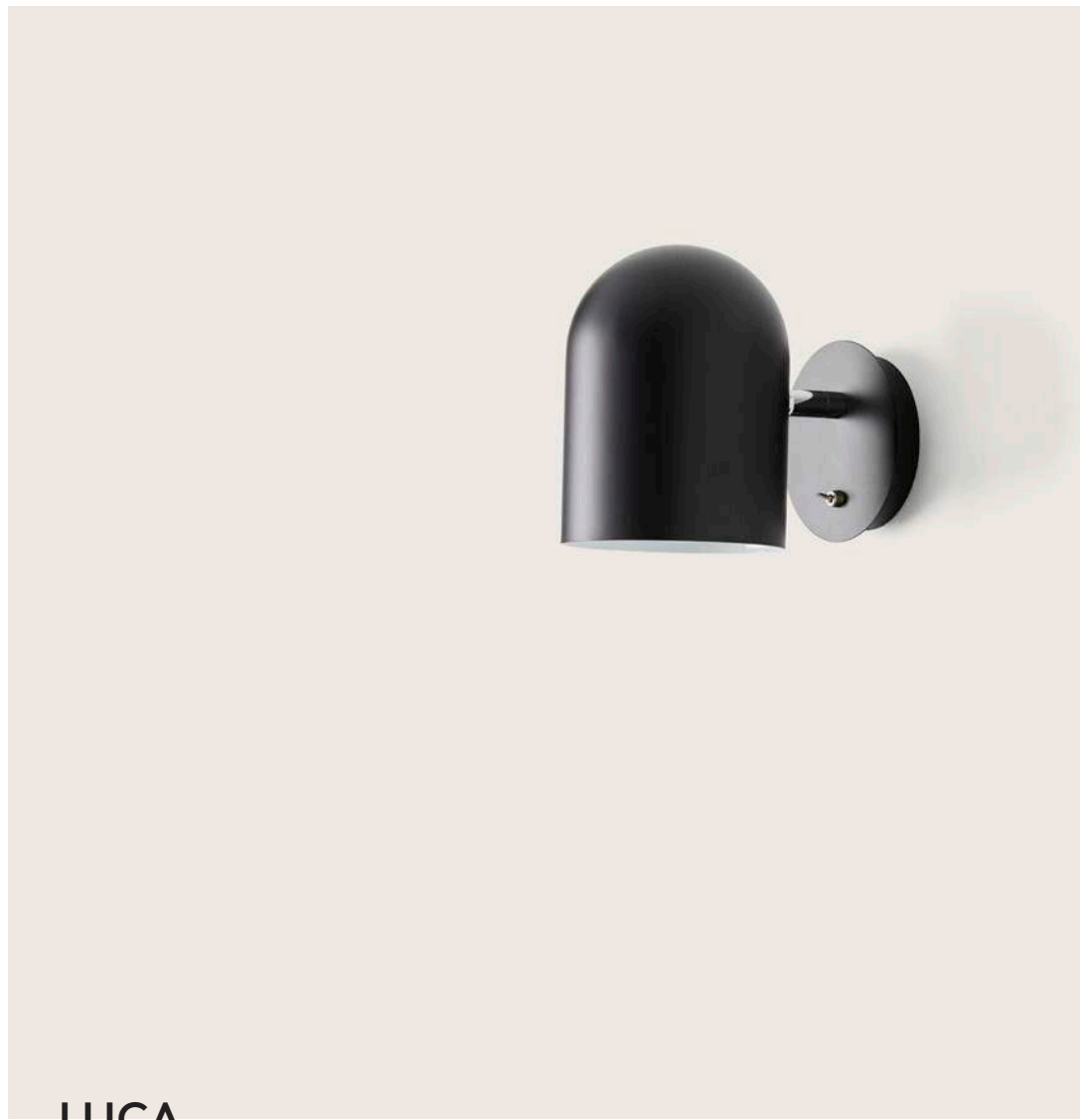

LUCA

DESIGNED BY AC STUDIO, 2017 · A1237

ES

ACABADOS
Metal:
Negro

MATERIALES
Acero

ESPECIFICACIONES (UE)
E27 Max. 60W (No incluida)
220-240 V, 50/60 Hz
IP20, Clase I



CLASIFICACIÓN ENERGÉTICA
A ++

BOMBILLA RECOMENDADA
B211 (7, 9, 11W)

EN

FINISHES
Metal:
Black

MATERIALS
Steel

SPECIFICATIONS (UE)
E27 Max. 60W (Not included)
220-240 V, 50/60 Hz
IP20, Class I



ENERGY LABEL
A ++

RECOMMENDED BULB
B211 (7, 9, 11W)

TEC

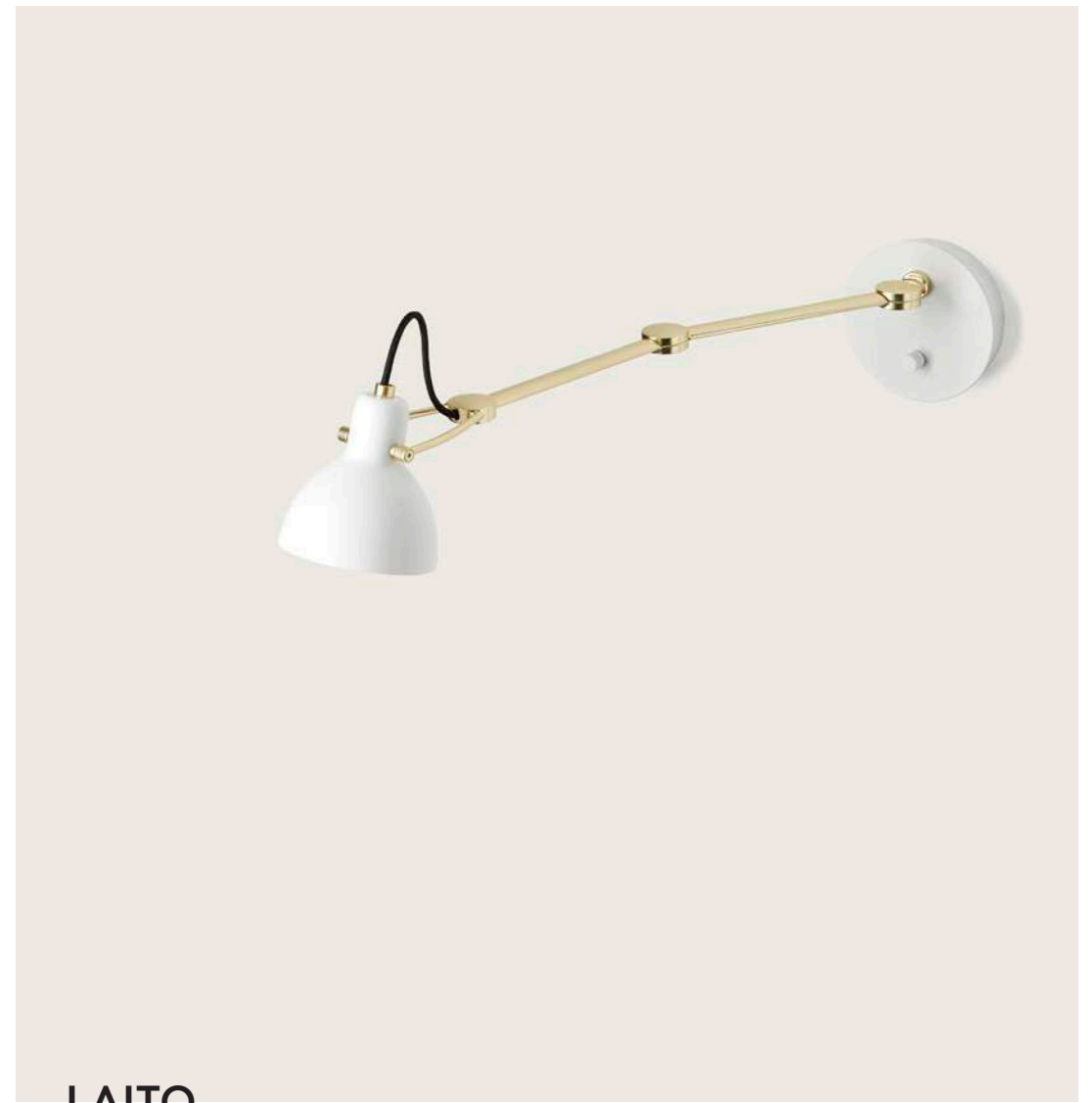
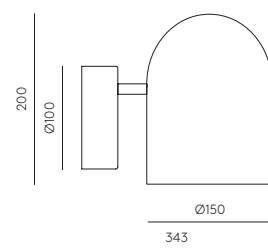

LAITO

DESIGNED BY JF SEVILLA, 2017 · A1231

ES

ACABADOS
Metal:
Blanco Mate
Oro Mate (brazo)

MATERIALES
Acero

ESPECIFICACIONES (UE)
E14 Max. 60W (No incluida)
220-240 V, 50/60 Hz
IP20, Clase I



CLASIFICACIÓN ENERGÉTICA
A ++

BOMBILLA RECOMENDADA
B116-2

EN

FINISHES
Metal:
Matt White
Matt Brass (arm)

MATERIALS
Steel

SPECIFICATIONS (UE)
E14 Max. 60W (Not included)
220-240 V, 50/60 Hz
IP20, Class I



ENERGY LABEL
A ++

RECOMMENDED BULB
B116-2

TEC

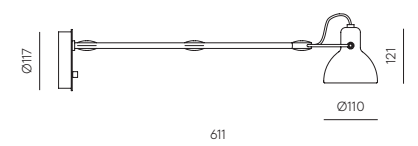



LITA

DESIGNED BY PEPE FORNAS, 2020 · A1230

ES

ACABADOS

Metal: Negro Mate
Madera: Negro Mate Nogal

MATERIALES

Acero / Madera nogal

ESPECIFICACIONES (UE)

COB LED integrado
3W 3000K (Incluida)
12V / 220-240 V, 50/60 Hz
IP20

CLASIFICACIÓN ENERGÉTICA
A ++

EN

FINISHES

Metal: Matt Black
Wood: Matt black Walnut

MATERIALS

Steel / Walnut Wood

SPECIFICATIONS (UE)

LED COB integrated
3W 3000K (Included)
12V / 220-240 V, 50/60 Hz
IP20

ENERGY LABEL
A ++

TEC

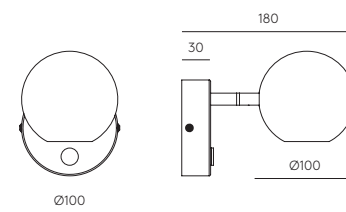

NERA

DESIGNED BY PEPE FORNAS, 2020 · A1229

ES

ACABADOS
Metal: Negro Mate

MATERIALES
Acero / Acrílico

ESPECIFICACIONES (UE)

COB LED integrado 8W 3000K
(Incluida)
12V / 220-240 V, 50/60 Hz
IP20

CLASIFICACIÓN ENERGÉTICA
A ++

EN

FINISHES
Metal: Matt Black

MATERIALS
Steel / Acrylic

SPECIFICATIONS (UE)

LED COB integrated 8W 3000K
(Included)
12V / 220-240 V, 50/60 Hz
IP20

ENERGY LABEL
A ++

TEC

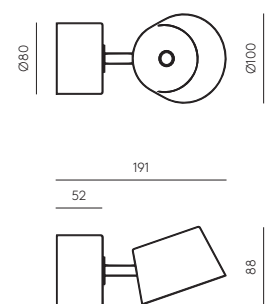



ALOA

DESIGNED BY FORNASEVI, 2017 · A1227

ES

ACABADOS
Metal: Negro Mate Difusor interior: Oro Brillo

MATERIALES
Acero

ESPECIFICACIONES (UE)
E27 Max. 60W (No incluida)
220-240 V, 50/60 Hz
IP20, Clase II



CLASIFICACIÓN ENERGÉTICA
A ++

BOMBILLA RECOMENDADA
B038 / Cromo

EN

FINISHES
Metal: Matt Black Diffuser: Shiny Gold

MATERIALS
Steel

SPECIFICATIONS (UE)
E27 Max. 60W (Not included)
220-240 V, 50/60 Hz
IP20, Class II



ENERGY LABEL
A ++

RECOMMENDED BULB
B038 / Chrome

TEC

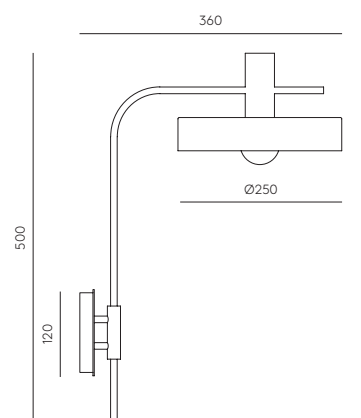



DELIE L

DESIGNED BY JF SEVILLA, 2020 · A1224 / L

ES

ACABADOS

Metal:	Mármol:	Tulipa:
Negro Mate	Blanco	Opal
Oro envejecido	Negro	Opal

MATERIALES

Metal / Mármol / Vidrio

ESPECIFICACIONES (UE)

G9 LED 5W 3000K (Incluida)
220-240 V, 50/60 Hz
IP20, Clase II

IP20      

CLASIFICACIÓN ENERGÉTICA

A ++

BOMBILLA RECOMENDADA

B005/5W

EN

FINISHES

Metal:	Marble:	Shade:
Matt Black	White Opal	Opal
Old Gold	Black	Opal

MATERIALS

Metal / Marble / Glass

SPECIFICATIONS (UE)

G9 LED 5W 3000K (Included)
220-240 V, 50/60 Hz
IP20, Class II

IP20      

ENERGY LABEL

A ++

RECOMMENDED BULB

B005/5W

TEC

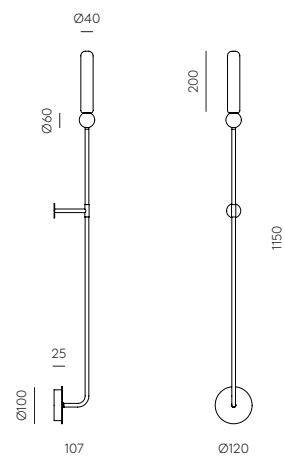



DELIE

DESIGNED BY JF SEVILLA, 2020 · A1224

ES

ACABADOS

Metal: Negro Mate
Oro envejecido

Mármol: Blanco
Negro

Tulipa: Opal
Opal

MATERIALES

Metal / Mármol / Vidrio

ESPECIFICACIONES (UE)

G9 LED 5W 3000K (Incluida)
220-240 V, 50/60 Hz
IP20, Clase II

IP20     

CLASIFICACIÓN ENERGÉTICA

A ++

BOMBILLA RECOMENDADA

B005/5W

EN

FINISHES

Metal: Matt Black
Old Gold

Marble: White Opal
Black

Shade: Opal
Opal

MATERIALS

Metal / Marble / Glass

SPECIFICATIONS (UE)

G9 LED 5W 3000K (Included)
220-240 V, 50/60 Hz
IP20, Class II

IP20     

ENERGY LABEL

A ++

RECOMMENDED BULB

B005/5W

TEC

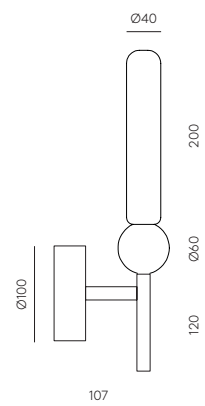

FEST

DESIGNED BY JF SEVILLA, 2016 · A1223

ES

ACABADOS

Metal: Oro Brillo
Cromo
Blanco
Negro

Cristal: Ambar
Rosa
Azul Oscuro
Turquesa
Marrón

MATERIALES

Acero / Cristal

ESPECIFICACIONES (UE)

E27 Max. 60W (No incluida)
220-240 V, 50/60 Hz, IP20,
Clase I

IP20     

CLASIFICACIÓN ENERGÉTICA

A ++

BOMBILLA IMAGEN

B038/CROMO

EN

FINISHES

Metal: Shiny Gold
Chrome
White
Black

Cable: Amber
Pink
Dark Blue
Turquoise
Brown

MATERIALS

Steel / Glass

SPECIFICATIONS (UE)

E27 Max. 60W (Not included)
220-240 V, 50/60 Hz, IP20,
Class I

IP20     

ENERGY LABEL

A ++

BULB IMAGE

B038/CROMO

TEC

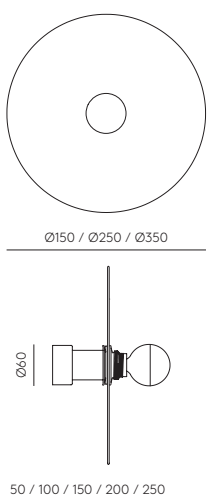



HELMET

DESIGNED BY PEPE FORNAS, 2016 · A1221

ES

ACABADOS

Metal:
Oro (Brillo o Mate)
Negro Mate
Cromo

MATERIALES

Acero / Vidrio Soplado

ESPECIFICACIONES (UE)

E27 (No incluida)
2700K - 270 lm
220-240 V, 50/60 Hz
IP20, Clase I

IP20

CLASIFICACIÓN ENERGÉTICA

A ++

BOMBILLA PARA A1221

B033/COB - Opal
B034/COB - Transparente

EN

FINISHES

Metal:
Shinny Gold or Matt Brass
Matt Black
Chrome

MATERIALS

Steel / Blown Glass

SPECIFICATIONS (UE)

E27 (Not included)
2700K - 270 lm
220-240 V, 50/60 Hz
IP20, Class I

IP20

ENERGY LABEL

A ++

BULB FOR A1221

B033/COB - Opal
B034/COB - Clear

TEC

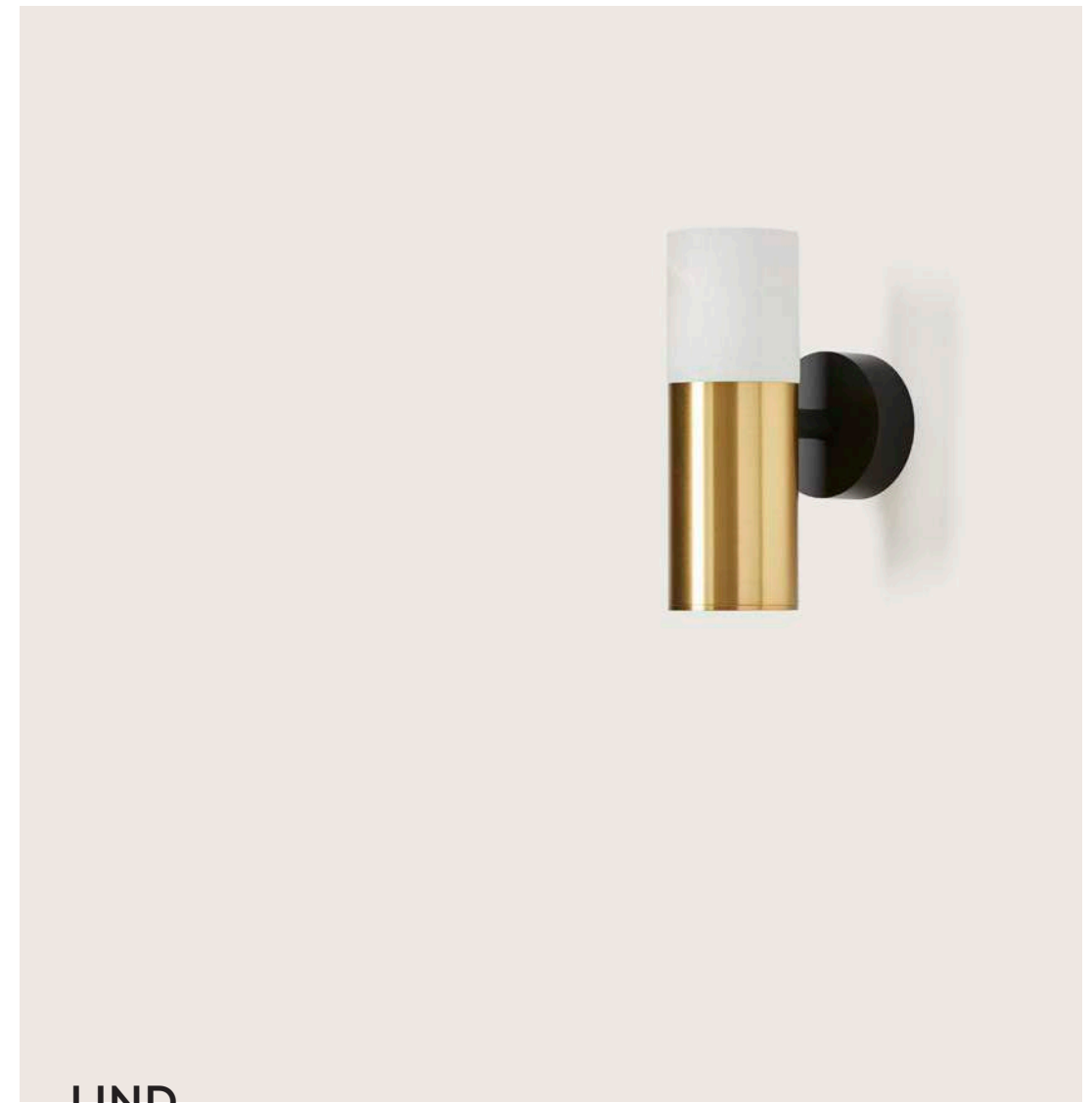
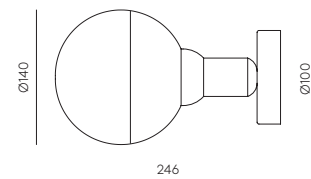

LIND

DESIGNED BY AGUSTÍN GASCÓN, 2020 · A1220

ES

ACABADOS

Metal:
Oro Mate
Negro Mate

Tulipa:
Alabastro

MATERIALES

Acero / Alabastro

ESPECIFICACIONES (UE)

G9 (Incluida)
5W - 3000K
220-240 V, 50/60 Hz
IP20, Clase I

IP20

CLASIFICACIÓN ENERGÉTICA

A ++

BOMBILLA RECOMENDADA

B005/5W

EN

FINISHES

Metal:
Matt Brass
Matt Black

Shade:
Alabaster

MATERIALS

Steel / Alabaster

SPECIFICATIONS (UE)

G9 (Included)
5W - 3000K
220-240 V, 50/60 Hz
IP20, Class I

IP20

ENERGY LABEL

A ++

RECOMMENDED BULB

B005/5W

TEC

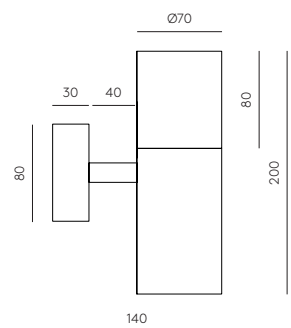







HELMET CURVE

DESIGNED BY PEPE FORNAS, 2016 · A1219

ES

ACABADOS
Metal:
Oro Mate
Negro Mate

MATERIALES
Acero / Vidrio Soplado

ESPECIFICACIONES (UE)
E27 - B033/COB incluida (opal)
3W - 3000K
220-240 V, 50/60 Hz
IP20, Clase I
IP20    





CLASIFICACIÓN ENERGÉTICA
A ++

MODIFICACIONES POSIBLES
B034/COB - Transparente

EN

FINISHES
Metal:
Matt Brass
Matt Black

MATERIALS
Steel / Blown Glass

SPECIFICATIONS (UE)
E27 - B033/COB included (opal)
3W - 3000K
220-240 V, 50/60 Hz
IP20, Class I
IP20    

ENERGY LABEL
A ++

POSSIBLE MODIFICATIONS
B034/COB - Clear

TEC

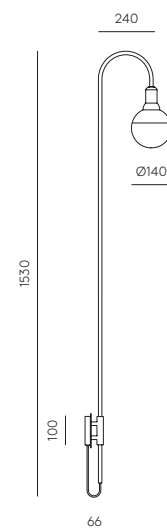





RAIN

DESIGNED BY JF SEVILLA, 2020 · A1218/R

ES

ACABADOS
Metal:
Oro Mate

MATERIALES
Latón

ESPECIFICACIONES (UE)
E27 (No incluida)
220-240 V, 50/60 Hz
IP20, Clase I
IP20    

ACCESORIOS NO INCLUIDOS





CLASIFICACIÓN ENERGÉTICA
A ++

BOMBILLAS RECOMENDADAS
B046/COB
COBLED

EN

FINISHES
Metal:
Matt Brass

MATERIALS
Brass

SPECIFICATIONS (UE)
E27 (Not included)
220-240 V, 50/60 Hz
IP20, Class I
IP20    

ACCESSORIES NOT INCLUDED

ENERGY LABEL
A ++

RECOMMENDED BULB
B046/COB
COBLED

TEC

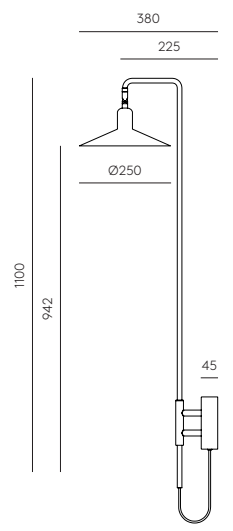



ATOM

DESIGNED BY AC STUDIO, 2016 · A1214

ES

ACABADOS
Metal: Negro Mate / Oro Mate
Cristal (Incluido) Opal/Transparente / Opal/Transparente

MATERIALES
 Acero / Vidrio Soplado

ESPECIFICACIONES (UE)
 Bombilla G9 (Incluida)
 5W - 2700K
 220-240 V, 50/60 Hz
 IP20, Clase I

IP20 CE RoHS WEEE A++

CLASIFICACIÓN ENERGÉTICA
 A ++

BOMBILLA INCLUIDA
 B005/5W

EN

FINISHES
Metal: Matt Black / Matt Brass
Shade (Included) Opal/Clear / Opal/Clear

MATERIALS
 Steel / Blown Glass

SPECIFICATIONS (UE)
 Bulb G9 (Included)
 5W - 2700K
 220-240 V, 50/60 Hz
 IP20, Class I

IP20 CE RoHS WEEE A++

ENERGY LABEL
 A ++

BULB INCLUDED
 B005/5W

TEC

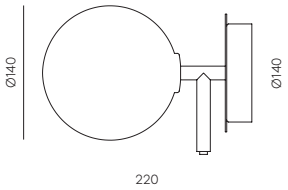



LAN

DESIGNED BY PEPE FORNAS, 2015 · A1210

ES

ACABADOS

Metal: Oro Mate
Oro Mate

Mármol: Blanco
Negro

Cristal: Opal
Opal

MATERIALES

Acero / Mármol / Cristal Soplado

ESPECIFICACIONES (UE)

Chip Led integrado
3W - 2700K
12 V, 50/60 Hz
IP20, Clase I

IP20     

CLASIFICACIÓN ENERGÉTICA

A ++

EN

FINISHES

Metal: Matt Brass
Matt Brass

Marble: White
Black

Glass: Opal
Opal

MATERIALS

Steel / Marble / Blown Glass

SPECIFICATIONS (UE)

Chip Led integrated
3W - 2700K
12 V, 50/60 Hz
IP20, Class I

IP20     

ENERGY LABEL

A ++

TEC

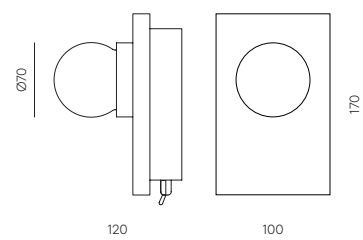





PIN

DESIGNED BY PEPE FORNAS, 2020 · A1209

ES

ACABADOS
Metal:
Oro Mate
Negro Mate

MATERIALES
Acero / Vidrio Soplado

ESPECIFICACIONES (UE)
E27 max. 60W (Bombilla No incluida)
220-240 V, 50/60 Hz
IP20, Clase I
IP20     





CLASIFICACIÓN ENERGÉTICA
A ++

BOMBILLA IMAGEN:
B053 / B054

EN

FINISHES
Metal:
Matt Brass
Matt Black

MATERIALS
Steel / Blown Glass

SPECIFICATIONS (UE)
E27 max. 60W (Bulb Not included)
220-240 V, 50/60 Hz
IP20, Class I
IP20     

ENERGY LABEL
A ++

IMAGE BULB:
B053 / B054

TEC

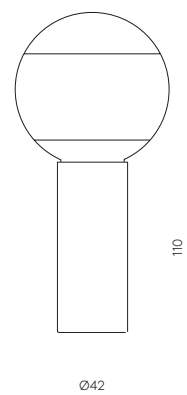



DOBI

DESIGNED BY AC STUDIO, 2015 · A1207

ES

ACABADOS
Metal:
Negro Mate
Blanco Mate

MATERIALES
Acero

ESPECIFICACIONES (UE)
E14 Max. 40W (No incluida)
220-240 V, 50/60 Hz
IP20, Clase I
IP20     





CLASIFICACIÓN ENERGÉTICA
A ++

BOMBILLA RECOMENDADA
B116-2 / 5W

EN

FINISHES
Metal:
Matt Black
Matt White

MATERIALS
Steel

SPECIFICATIONS (UE)
E14 Max. 40W (Not included)
220-240 V, 50/60 Hz
IP20, Class I
IP20     

ENERGY LABEL
A ++

RECOMMENDED BULB
B116-2 / 5W

TEC

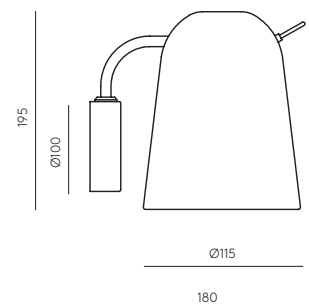



COSS

DESIGNED BY AC STUDIO, 2020 · A1203

ES

ACABADOS

Cúpula:
Negro
Blanco

Difusor:
Negro
Blanco
Oro Mate
Cromo

MATERIALES

Acero / Acrílico

MEDIDAS:

A1203/40: Cúpula - 40 cm
Difusor - 25 cm

A1203/60: Cúpula - 60 cm
Difusor - 40 cm

ESPECIFICACIONES (UE)

A1203/40: LED integrado 12W 3000K
A1203/60: LED integrado 21W 3000K
220-240 V, 50/60 Hz, IP20, Clase I

IP20 CE RoHS ENEC A++

CLASIFICACIÓN ENERGÉTICA

A ++

EN

FINISHES

Dome:
Black
White

Diffuser:
Black
White
Matt Brass
Chrome

MATERIALS

Steel / Acrylic

SIZES:

A1203/40: Dome - 40 cm
Diffuser - 25 cm

A1203/60: Dome - 60 cm
Diffuser - 40 cm

SPECIFICATIONS (UE)

A1203/40: Integrated LED 12W 3000K
A1203/60: Integrated LED 21W 3000K
220-240 V, 50/60 Hz, IP20, Class I

IP20 CE RoHS ENEC A++

ENERGY LABEL

A ++

TEC A1203/40

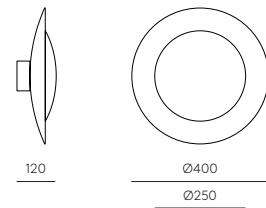

TEC A1203/60

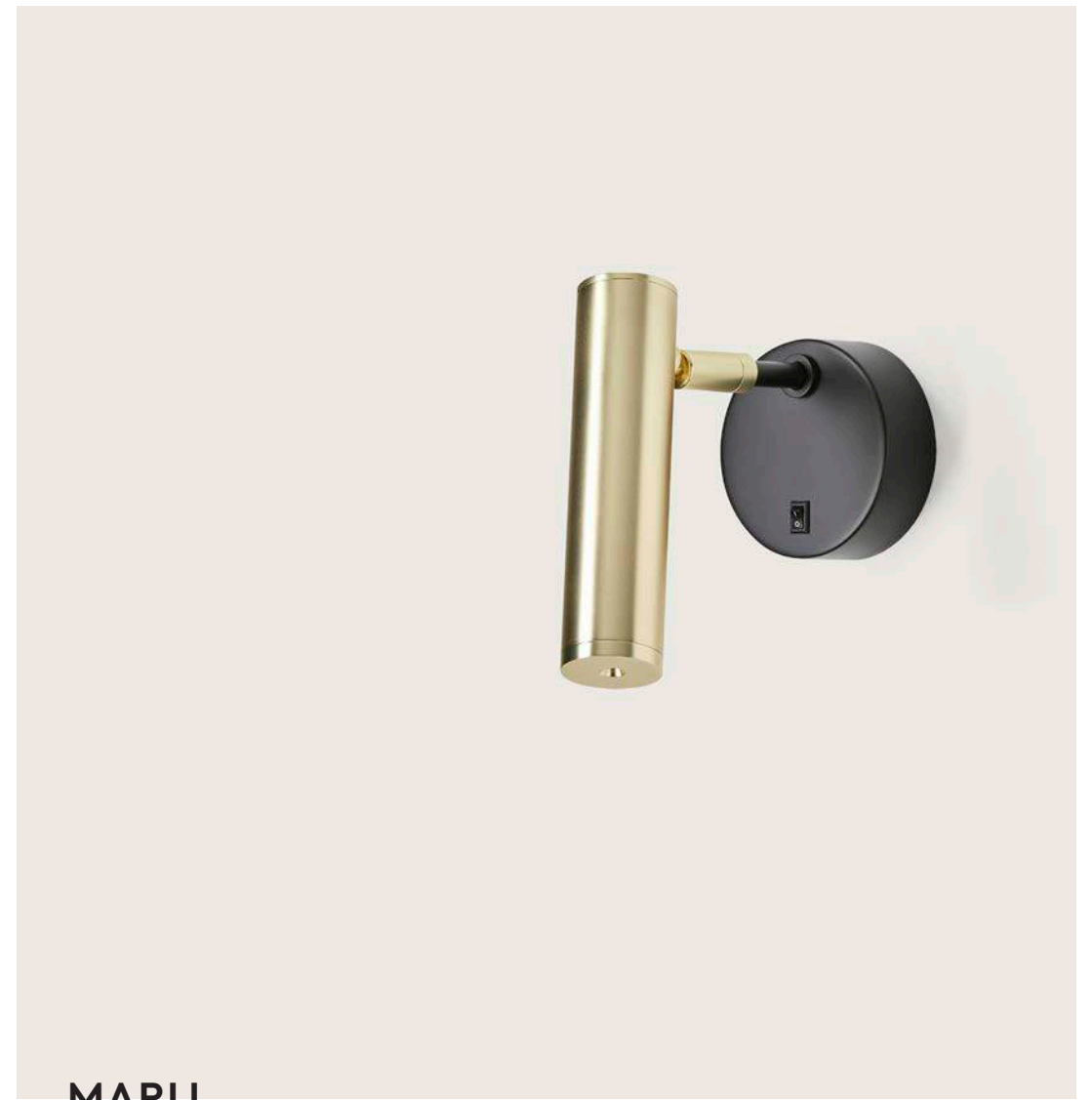
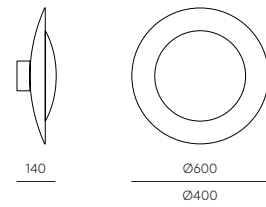

MARU

DESIGNED BY JF SEVILLA, 2015 · A1194

ES

ACABADOS

Florón:
Negro Mate
Negro Mate

Cabeza:
Oro Mate
Negro Mate

MATERIALES

Acero

ESPECIFICACIONES (UE)

Chip Led integrado
3W - 3150K
12 V, 50/60 Hz
IP20, Clase I

IP20 CE RoHS ENEC A++

CLASIFICACIÓN ENERGÉTICA

A ++

EN

FINISHES

Canopy:
Matt Black
Matt Black

Head:
Matt Brass
Matt Black

MATERIALS

Steel

SPECIFICATIONS (UE)

Chip Led Integrated
3W - 3150K
12 V, 50/60 Hz
IP20, Class I

IP20 CE RoHS ENEC A++

ENERGY LABEL

A ++

TEC

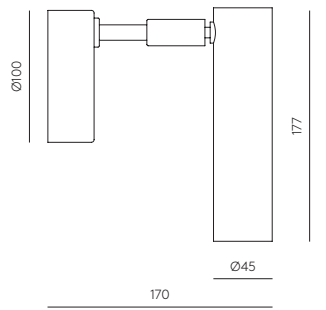

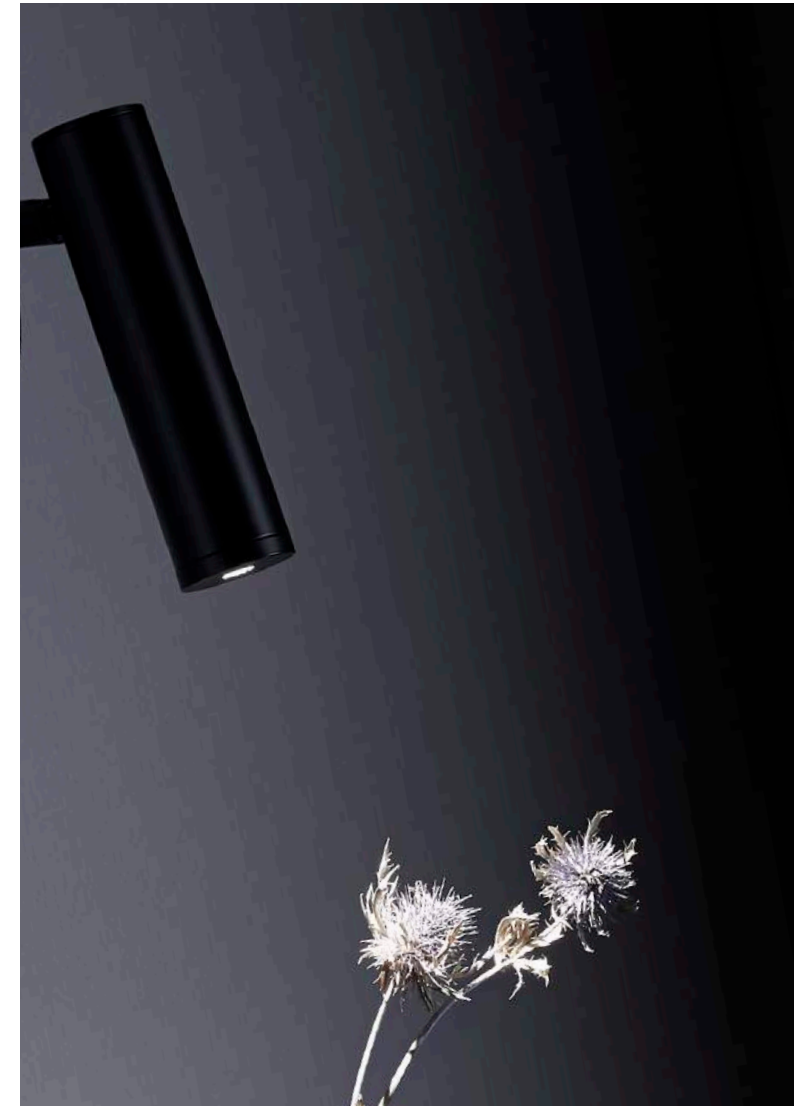



SNOW FLAKE

DESIGNED BY JANA CHANG, 2014 · A1179

ES

ACABADOS

Metal: Oro Brillo
Cromo

Cristal: Transparente
Transparente

MATERIALES

Acero / Vidrio Soplado

ESPECIFICACIONES (UE)

E27 Max. 60W (No incluida)
220-240 V, 50/60 Hz
IP20, Clase I

IP20      

CLASIFICACIÓN ENERGÉTICA

A ++

BOMBILLA IMAGEN

B038/CROMO

EN

FINISHES

Metal: Shiny Gold
Chrome

Glass Shade: Clear
Clear

MATERIALS

Steel / Blown Glass

SPECIFICATIONS (UE)

E27 Max. 60W (Not included)
220-240 V, 50/60 Hz
IP20, Class I

IP20     

ENERGY LABEL

A ++

BULB IMAGE

B038/CHROME

TEC

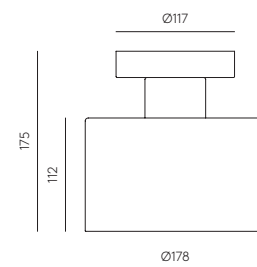

LOTTO

DESIGNED BY AC STUDIO, 2014 · A1176/75/74

ES

ACABADOS

Metal: Oro Brillo
Cromo
Blanco
Negro

Cristal: Transparente
Transparente
Transparente
Transparente

MATERIALES

Acero / Cristal

ESPECIFICACIONES (UE)

Bombilla Led incluida - B030
2W - 2700K
IP20, Clase I

IP20     

CLASIFICACIÓN ENERGÉTICA

A ++

MEDIDAS

A1176 - Ø250 x 150
A1175 - Ø200 x 120
A1174 - Ø150 x 100

EN

FINISHES

Metal: Shiny Gold
Chrome
White
Black

Glass: Clear
Clear
Clear
Clear

MATERIALS

Steel / Glass

SPECIFICATIONS (UE)

Bulb Led included - B030
2W - 2700K
IP20, Class I

IP20     

ENERGY LABEL

A ++

SIZES

A1176 - Ø250 x 150
A1175 - Ø200 x 120
A1174 - Ø150 x 100

TEC

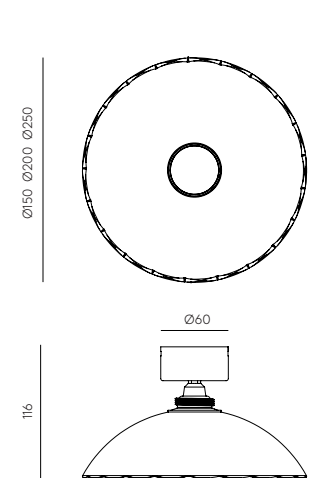

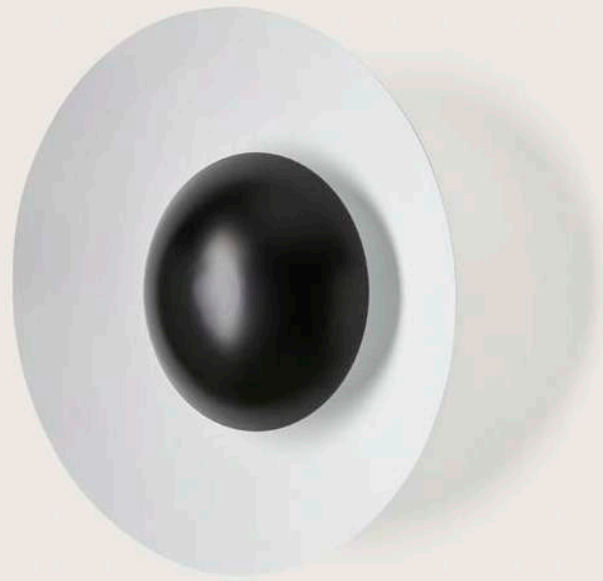

ROSS

DESIGNED BY AC STUDIO, 2014 · A1173

ES

ACABADOS

Cúpula Interior:	Cúpula Exterior:
Oro Mate	Blanco Mate
Cromo	Blanco Mate
Oro Brillo	Blanco Mate
Negro Mate	Blanco Mate

MATERIALES

Acero

ESPECIFICACIONES (UE)

G9 Led (Incluida)
 3 x 3W - 3000K
 220-240 V, 50/60 Hz
 IP20, Clase I



CLASIFICACIÓN ENERGÉTICA

A ++

BOMBILLA RECOMENDADA

B005

EN

FINISHES

Metal Small:	Metal Big:
Matt Brass	Matt White
Chrome	Matt White
Shinny Gold	Matt White
Matt Black	Matt White

MATERIALES

Steel

SPECIFICATIONS (UE)

G9 Led (Included)
 3 x 3W - 3000K
 220-240 V, 50/60 Hz
 IP20, Class I



ENERGY LABEL

A ++

RECOMMENDED BULB

B005

TEC

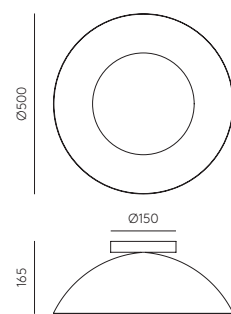



XTRA

DESIGNED BY AC STUDIO, 2014 · A1172

ES

ACABADOS
Metal:
Negro Mate

Portalámparas:
Oro Brillo

MATERIALES
Acero

ESPECIFICACIONES (UE)
E27 Max. 60W (No incluida)
220-240 V, 50/60 Hz
IP20, Clase I

↔ IP20

CLASIFICACIÓN ENERGÉTICA
A ++

BOMBILLA IMAGEN
B048

MEDIDAS
1000 mm

EN

FINISHES
Metal:
Matt Black

Lampholder:
Shinny Gold

MATERIALS
Steel

SPECIFICATIONS (UE)
E27 Max. 60W (Not included)
220-240 V, 50/60 Hz
IP20, Class I

↔ IP20

ENERGY LABEL
A ++

BULB IMAGE
B048

SIZES
1000 mm

TEC

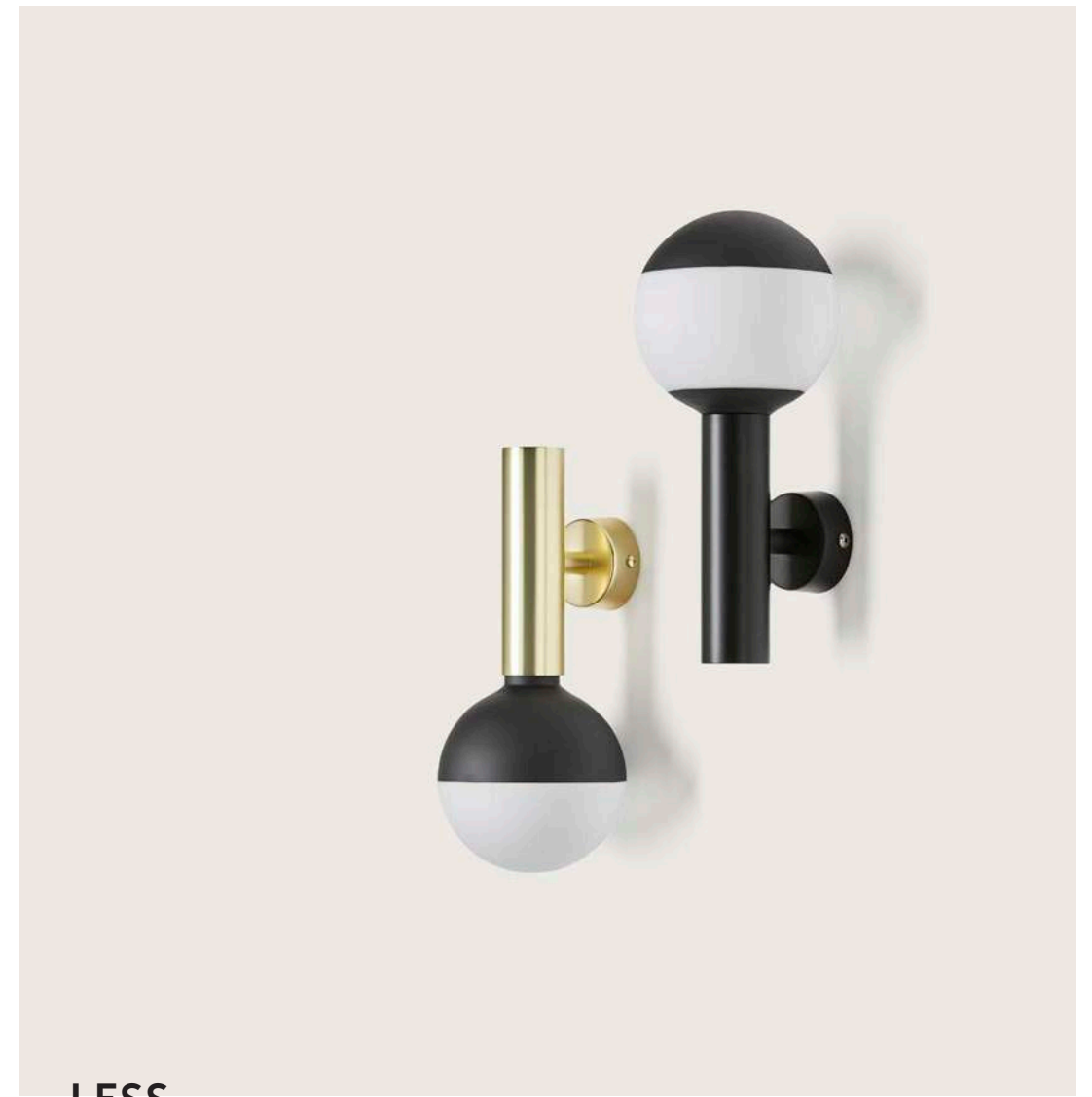
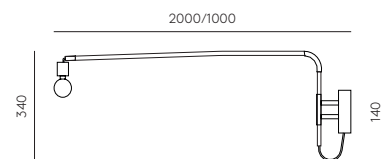

LESS

DESIGNED BY JF SEVILLA, 2014 · A1171

ES

ACABADOS
Metal:
Oro Mate
Cromo
Negro Mate

MATERIALES
Acero

ESPECIFICACIONES (UE)
E27 Max. 33W (No incluida)
220-240 V, 50/60 Hz
IP20, Clase I

IP20

BOMBILLA IMAGEN
B053 / B054

CLASIFICACIÓN ENERGÉTICA
A ++

EN

FINISHES
Metal:
Matt Brass
Chrome
Matt Black

MATERIALS
Steel

SPECIFICATIONS (UE)
E27 Max. 33W (Not included)
220-240 V, 50/60 Hz
IP20, Class I

IP20

BULB IMAGE
B053 / B054

ENERGY LABEL
A ++

TEC

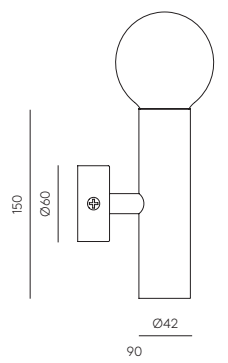

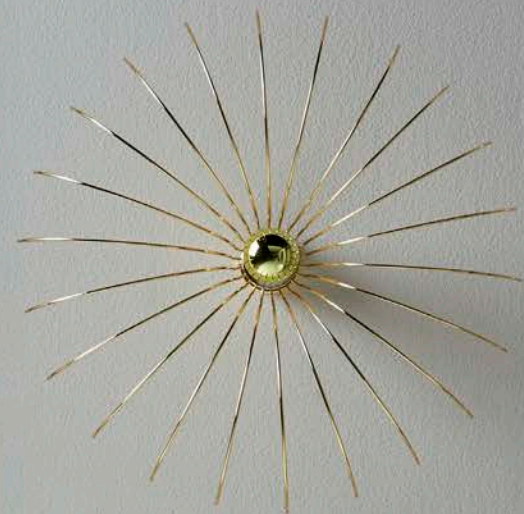

SPIDER

DESIGNED BY FORNASEVI, 2013 · A1163

ES

ACABADOS

Metal:
Oro Brillo
Cromo
Blanco
Negro

MATERIALES

Acero

ESPECIFICACIONES (UE)

E27 Max. 60W (No incluida)
220-240 V, 50/60 Hz
IP20, Clase I

IP20     

BOMBILLA IMAGEN

B038/Oro

CLASIFICACIÓN ENERGÉTICA

A ++

EN

FINISHES

Metal:
Shinny Gold
Chrome
White
Black

MATERIALS

Steel

SPECIFICATIONS (UE)

E27 Max. 60W (Not included)
220-240 V, 50/60 Hz
IP20, Class I

IP20     

BULB IMAGE

B038/Gold

ENERGY LABEL

A ++

TEC

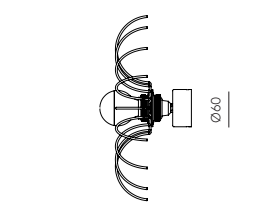
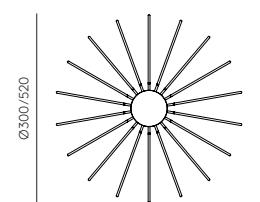

147



VENT

DESIGNED BY PEPE FORNAS, 2020 · A1161

ES

ACABADOS
Metal:
Negro Mate

Pai Pai:
Negro Mate
Natural

Ribete:
Negro
Natural / Negro

MATERIALES
Acero / Hoja de Palma

ESPECIFICACIONES (UE)
G9 LED 5W 3000K (Incluida)
220-240 V, 50/60 Hz

IP20     

CLASIFICACIÓN ENERGÉTICA
A ++

EN

FINISHES
Metal Small:
Matt Black

Pai Pai:
Matt black
Natural

Ribbon:
Black
Natural / Black

MATERIALS
Steel / Palm leaf

SPECIFICATIONS (UE)
G9 LED 5W 3000K (Included)
220-240 V, 50/60 Hz

IP20     

ENERGY LABEL
A ++

TEC

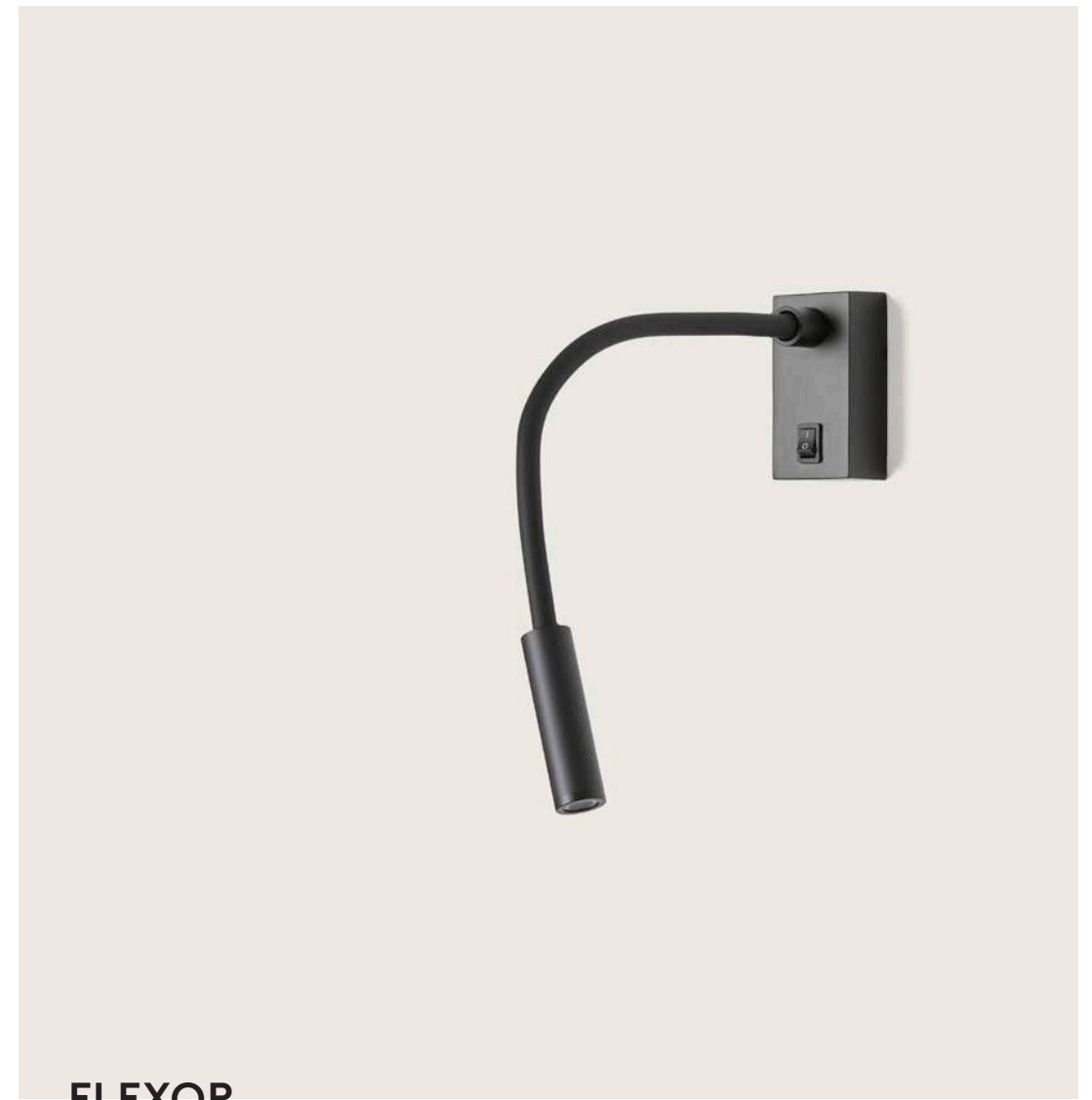
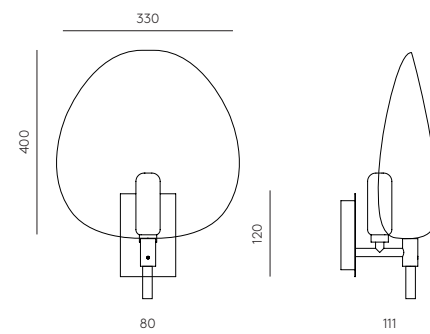





FLEXOR

DESIGNED BY AC STUDIO, 2009 · A1151

ES

ACABADOS
Metal:
Negro Mate
Blanco Mate

MATERIALES
Acero / Silicona





ESPECIFICACIONES (UE)
Led (Incluido)
3W - 3000K
12 V, 50/60 Hz
IP20, Clase I
IP20     

CLASIFICACIÓN ENERGÉTICA
A ++

EN

FINISHES
Metal:
Matt Black
Matt White

MATERIALS
Steel / Silicon

SPECIFICATIONS (UE)
Led (Included)
3W - 3000K
12 V, 50/60 Hz
IP20, Class I
IP20     

ENERGY LABEL
A ++

TEC

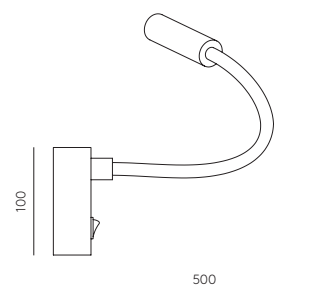



PILD

DESIGNED BY PEPE FORNAS, 2019 · A1149

ES

ACABADOS
Metal:
Oro Mate
Negro Mate

MATERIALES
Acero

ESPECIFICACIONES (UE)
Bombilla G9 LED (Incluida)
5W - 3000K
220-240 V, 50/60 Hz
IP20, Clase I



CLASIFICACIÓN ENERGÉTICA
A ++

BOMBILLA RECOMENDADA
B005

EN

FINISHES
Metal:
Matt Brass
Matt Black

MATERIALS
Steel

SPECIFICATIONS (UE)
Bulb G9 (included)
5W - 3000K
220-240 V, 50/60 Hz
IP20, Class I



ENERGY LABEL
A ++

RECOMMENDED BULB
B005/5W

TEC

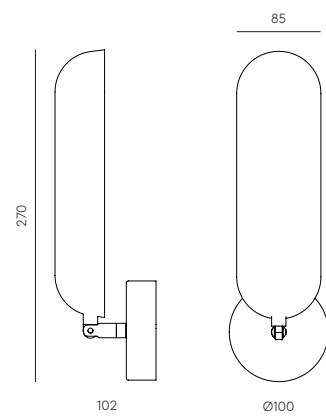

CAMB

DESIGNED BY JF SEVILLA, 2020 · A1142

ES

ACABADOS
Metal:
Oro Mate
Negro Mate

MATERIALES
Acero /Paja

ESPECIFICACIONES (UE)
E27 (No incluida)
220-240 V, 50/60 Hz
IP20, Clase I



BOMBILLA IMAGEN
B052

CLASIFICACIÓN ENERGÉTICA
A ++

Accesorio:
Paja

EN

FINISHES
Metal:
Matt Brass
Matt Black

MATERIALS
Steel / Dried Grass

SPECIFICATIONS (UE)
E27 (Not included)
220-240 V, 50/60 Hz
IP20, Class I



BULB IMAGE
B052

ENERGY LABEL
A ++

TEC

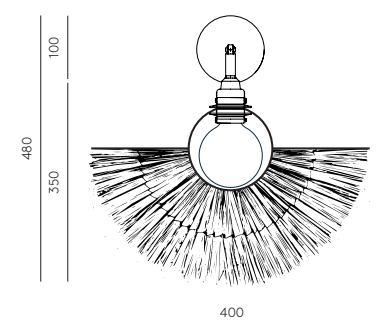





LAOS

DESIGNED BY JF SEVILLA, 2020 · A1053 + A1141

ES

ACABADOS

Metal:
Oro Brillo / Cromo
Blanco / Negro

Rueda:
Paja
Paja

MATERIALES

Acero / Paja Natural

ESPECIFICACIONES (UE)

E27 Max. 60W (No incluida)
220-240 V, 50/60 Hz, IP20,
Clase I

IP20     

CLASIFICACIÓN ENERGÉTICA

A ++

DIÁMETROS DISPONIBLES

30 y 50 cm

BOMBILLA

B035 (Ø95) B038 (Ø55)

SE VENDE POR SEPARADO

COMPOSICIÓN DE 3 PIEZAS

EN

FINISHES

Metal:
Shinny Gold / Chrome /
White / Black

Wheel:
Dried Grass
Dried Grass

MATERIALS

Steel / Natural Dried Grass

SPECIFICATIONS (UE)

E27 Max. 60W (Not included)
220-240 V, 50/60 Hz, IP20,
Class I

IP20     

ENERGY LABEL

A ++

AVAILABLE DIAMETERS

30 and 50 cm

BULB

B035 (Ø95) B038 (Ø55)

EACH PIECE SOLD SEPARATLY

COMPOSITION 3 PIECES

TEC

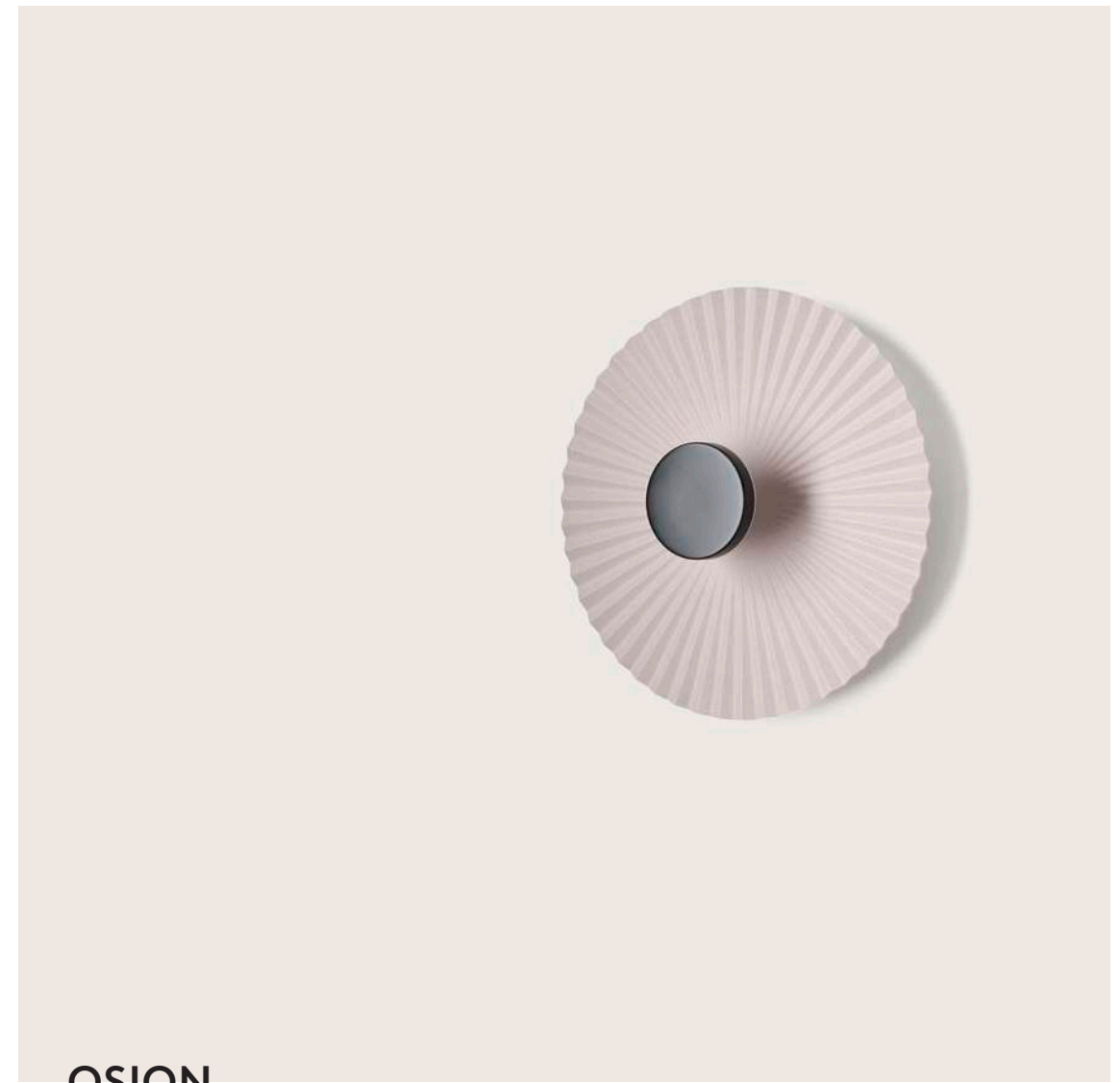
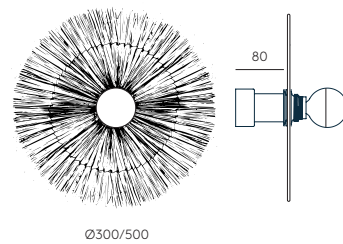

OSION

DESIGNED BY JF SEVILLA, 2019 · A1132

ES

ACABADOS

Metal:
Oro Mate
Cromo

Resina:
Blanca
Blanca

MATERIALES

Acero / Resina

ESPECIFICACIONES (UE)

Led Integrado
9W - 3000K
12V, 50/60Hz
IP20, Clase I

IP20     

CLASIFICACIÓN ENERGÉTICA

A ++

MODIFICACIONES POSIBLES

Para más colores consultar
pág. 372. Color resina imagen:
Rosa Palo.

EN

FINISHES

Metal:
Matt Brass
Chrome

Resin:
White
White

MATERIALS

Steel / Resin

SPECIFICATIONS (UE)

Led integrated
9W - 3000K
12V, 50/60Hz
IP20, Class I

IP20     

ENERGY LABEL

A ++

MODIFICACIONES POSIBLES

For more colors check on page.
372. Image resin color: Pale
Pink.

TEC

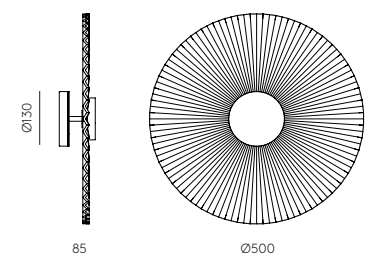

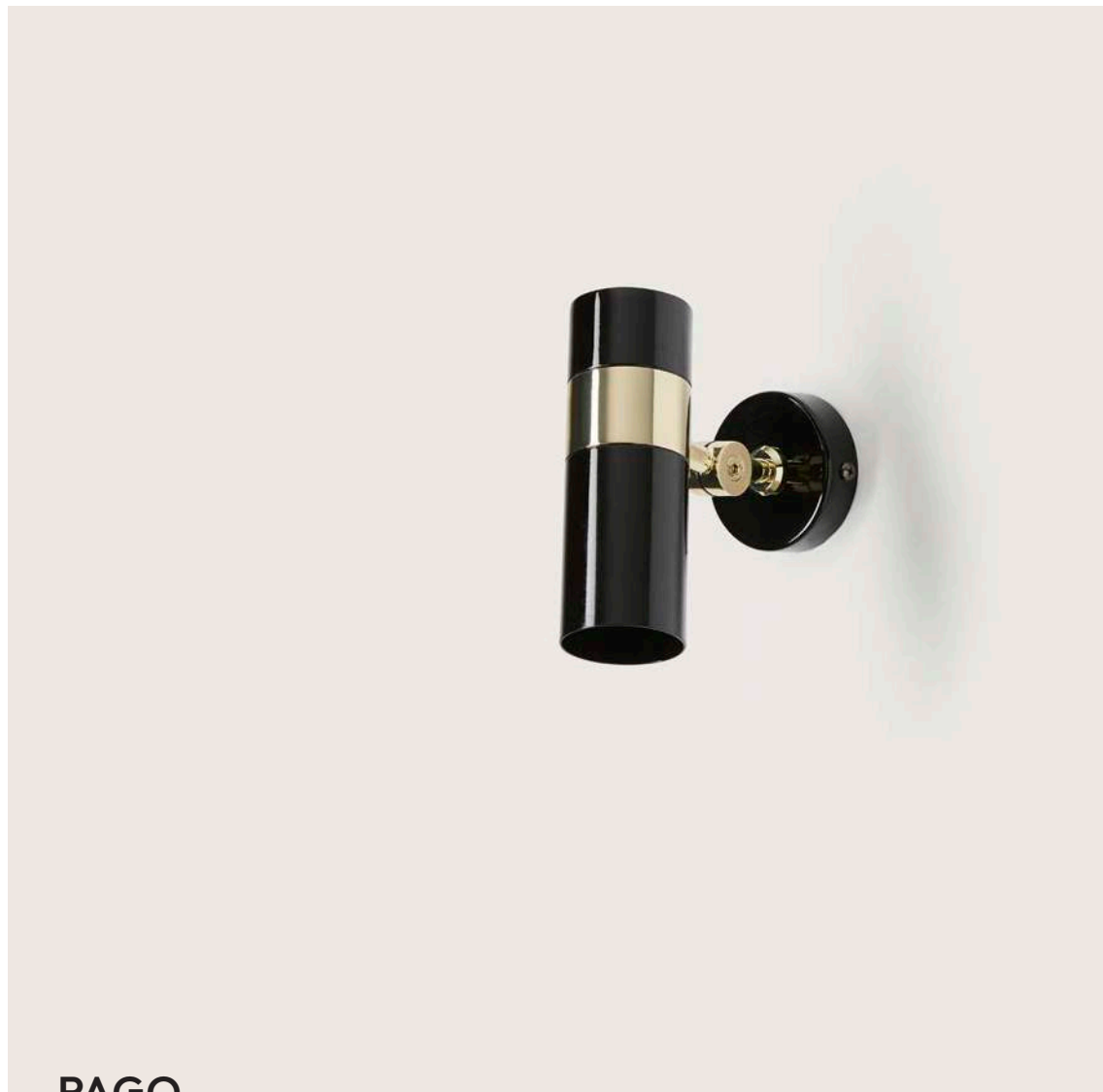

PAGO

DESIGNED BY PEPE FORNAS, 2010 · A1126

ES

ACABADOS

Metal:
Blanco brillo-Cromo
Negro brillo-Oro brillo
Negro brillo-Cromo

MATERIALES

Acero

ESPECIFICACIONES (UE)

GU10 Max. 50W (No incluida)
220-240 V, 50/60 Hz
IP20, Clase I



CLASIFICACIÓN ENERGÉTICA

A ++

BOMBILLA RECOMENDADA

B161(5W)

EN

FINISHES

Metal:
Shinny white-Chrome
Shinny black-Shinny gold
Shinny black-Chrome

MATERIALS

Steel

SPECIFICATIONS (UE)

GU10 Max. 50W (Not included)
220-240 V, 50/60 Hz
IP20, Class I



ENERGY LABEL

A ++

RECOMMENDED BULB

B161(5W)

TEC

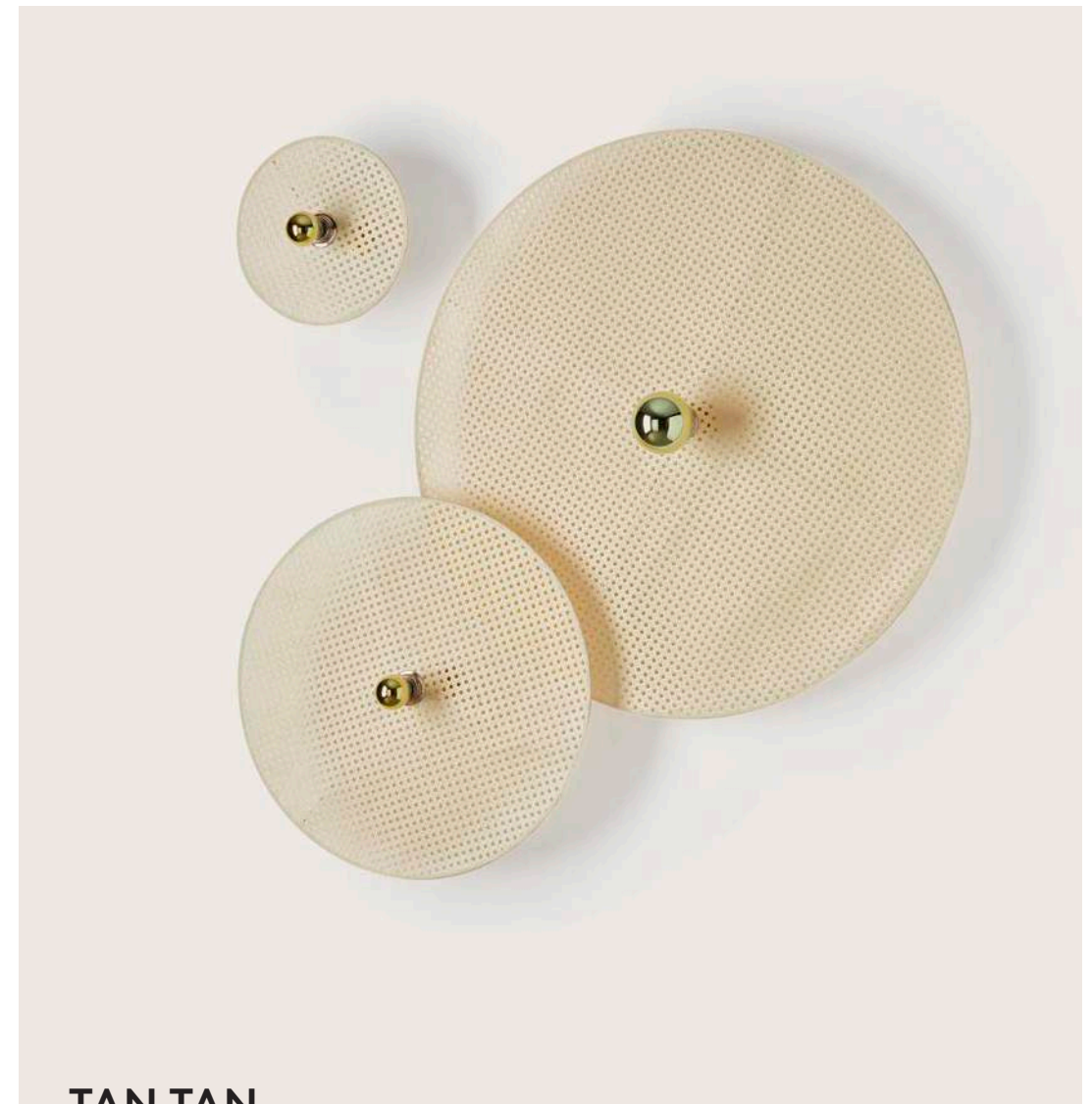
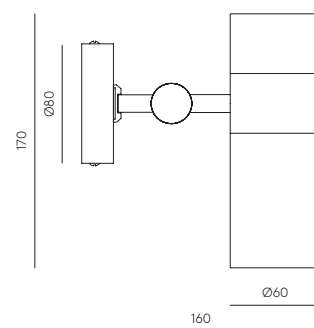

TAN TAN

DESIGNED BY FORNASEVI, 2018 · A1053 + 1125

ES

ACABADOS

Metal:
Oro Brillo
Cromo
Blanco
Negro

Rueda:
Natural/Negro
Natural/Negro
Natural/Negro
Natural/Negro

MATERIALES

Acero / Ratán

ESPECIFICACIONES (UE)

E27 Max. 60W (No incluida)
220-240 V, 50/60 Hz, IP20, Clase I



CLASIFICACIÓN ENERGÉTICA

A ++

MODIFICACIONES POSIBLES

Para modificaciones de colores de la rueda de ratán consultar. Se vende por separado. Foto composición 3 piezas.

BOMBILLA

B035 (Ø95) B038 (Ø55)

EN

FINISHES

Metal:
Shinny Gold
Chrome
White
Black

Wheel:
Natural/Black
Natural/Black
Natural/Black
Natural/Black

MATERIALS

Steel / Rattan

SPECIFICATIONS (UE)

E27 Max. 60W (Not included)
220-240 V, 50/60 Hz, IP20, Class I



ENERGY LABEL

A ++

POSSIBLE MODIFICATIONS

Rattan color can be changed, ask us. Each piece sold separately. Composition in photo with 3 pieces

BULB

B035 (Ø95) B038 (Ø55)

TEC

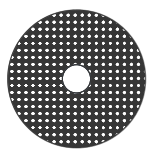

Ø300 / Ø600 / Ø900

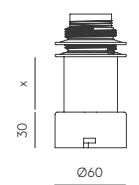

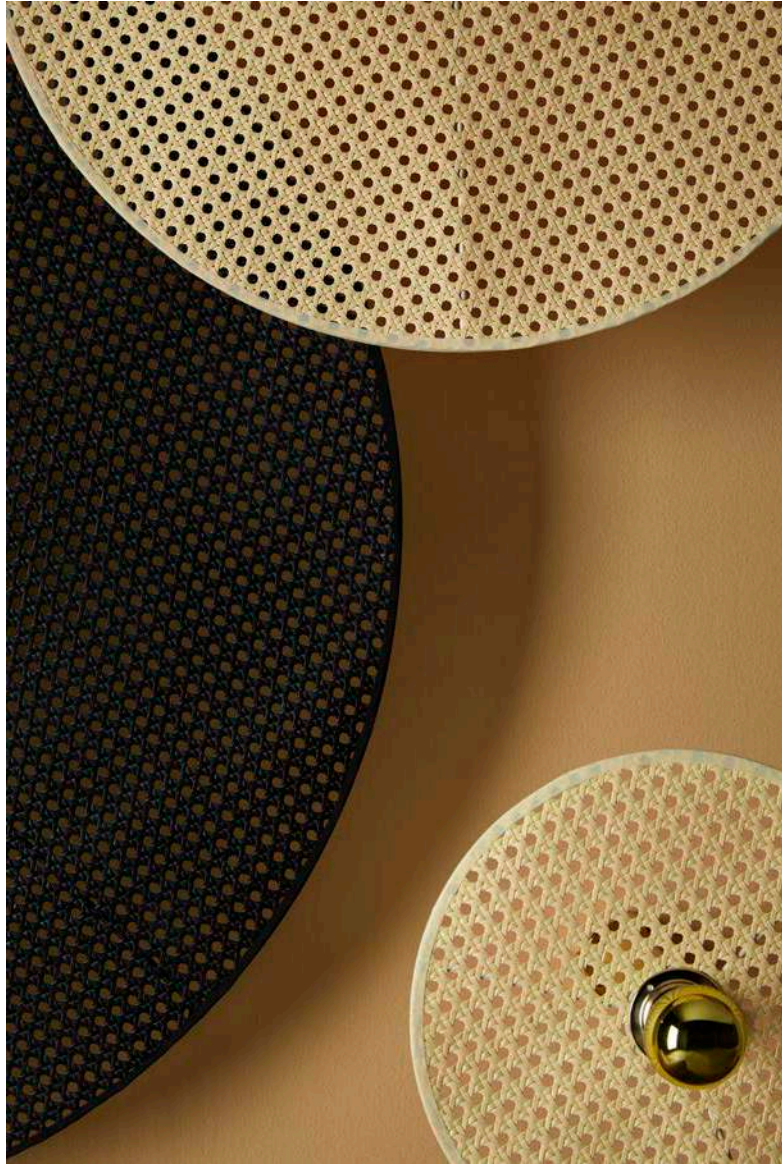



COHEN

DESIGNED BY JANA CHANG, 2010 · A1122

ES

ACABADOS

Metal: Cromo
Cromo
Tulipa: Negro Brillo
Blanco Brillo

MATERIALES

Acero

ESPECIFICACIONES (UE)

E27 Max. 60W (No incluida)
220-240 V, 50/60 Hz
IP20, Clase I

IP20     

CLASIFICACIÓN ENERGÉTICA

A ++

BOMBILLA RECOMENDADA

B211 (7, 9, 11W)

EN

FINISHES

Metal: Chrome
Chrome
Shade: Shiny White
Shiny Black

MATERIALS

Steel

SPECIFICATIONS (UE)

E27 Max. 60W (Not included)
220-240 V, 50/60 Hz
IP20, Class I

IP20     

ENERGY LABEL

A ++

RECOMMENDED BULB

B211 (7, 9, 11W)

TEC

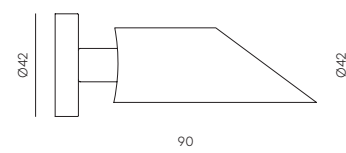

GLOP

DESIGNED BY AC STUDIO, 2009 · A1113

ES

ACABADOS

Metal: Cromo
Cromo
Textil: Blanco
Blanco

MATERIALES

Acero / Pantalla Textil

ESPECIFICACIONES (UE)

E27 Max. 60W (No incluida)
220-240 V, 50/60 Hz
LED 3W - 3000K
12V, 50/60 Hz
IP20, Clase I

IP20     

CLASIFICACIÓN ENERGÉTICA

A ++

PANTALLA INCLUIDA

BOMBILLA E27 RECOMENDADA

B211 (7, 9, 11W)

EN

FINISHES

Metal: Chrome
Chrome
Fabric: White
White

MATERIALS

Steel / Fabric

SPECIFICATIONS (UE)

E27 Max. 60W (Not included)
220-240 V, 50/60 Hz
LED 3W - 3000K
12V, 50/60 Hz
IP20, Class I

IP20     

ENERGY LABEL

A ++

SHADE INCLUDED

RECOMMENDED E27 BULB

B211 (7, 9, 11W)

TEC

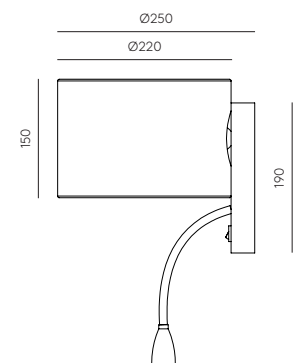



FIND

DESIGNED BY AC STUDIO · A1110

ES

ACABADOS
Metal:
Cromo

MATERIALES
Acero

ESPECIFICACIONES (UE)
Led 3W (Incluida)
3000K
12 V, 50/60 Hz
IP20, Clase I



CLASIFICACIÓN ENERGÉTICA
A ++

EN

FINISHES
Metal:
Chrome

MATERIALS
Steel

SPECIFICATIONS (UE)
Led 3W (Included)
3000K
12 V, 50/60 Hz
IP20, Class I



ENERGY LABEL
A ++

TEC

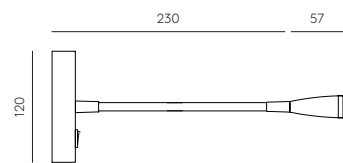

EHY

DESIGNED BY AC STUDIO, 2018 · A1105

ES

ACABADOS
Metal:
Oro Mate - Interior
Negro Mate - Exterior

MATERIALES
Acero

ESPECIFICACIONES (UE)
E27 60w Max. (No Incluida)
220-240 V, 50/60 Hz,
IP20, Clase I



CLASIFICACIÓN ENERGÉTICA
A ++

BOMBILLA IMAGEN
B038 ORO

EN

FINISHES
Metal:
Matt Gold - Inside
Matt Black - Outside

MATERIALS
Steel

SPECIFICATIONS (UE)
E27 60w Max.(Not Included)
220-240 V, 50/60 Hz,
IP20, Class I



ENERGY LABEL
A ++

IMAGE BULB
B038 GOLD

TEC

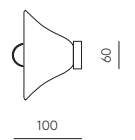
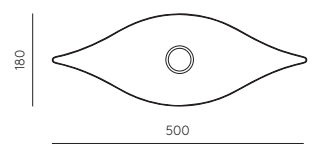

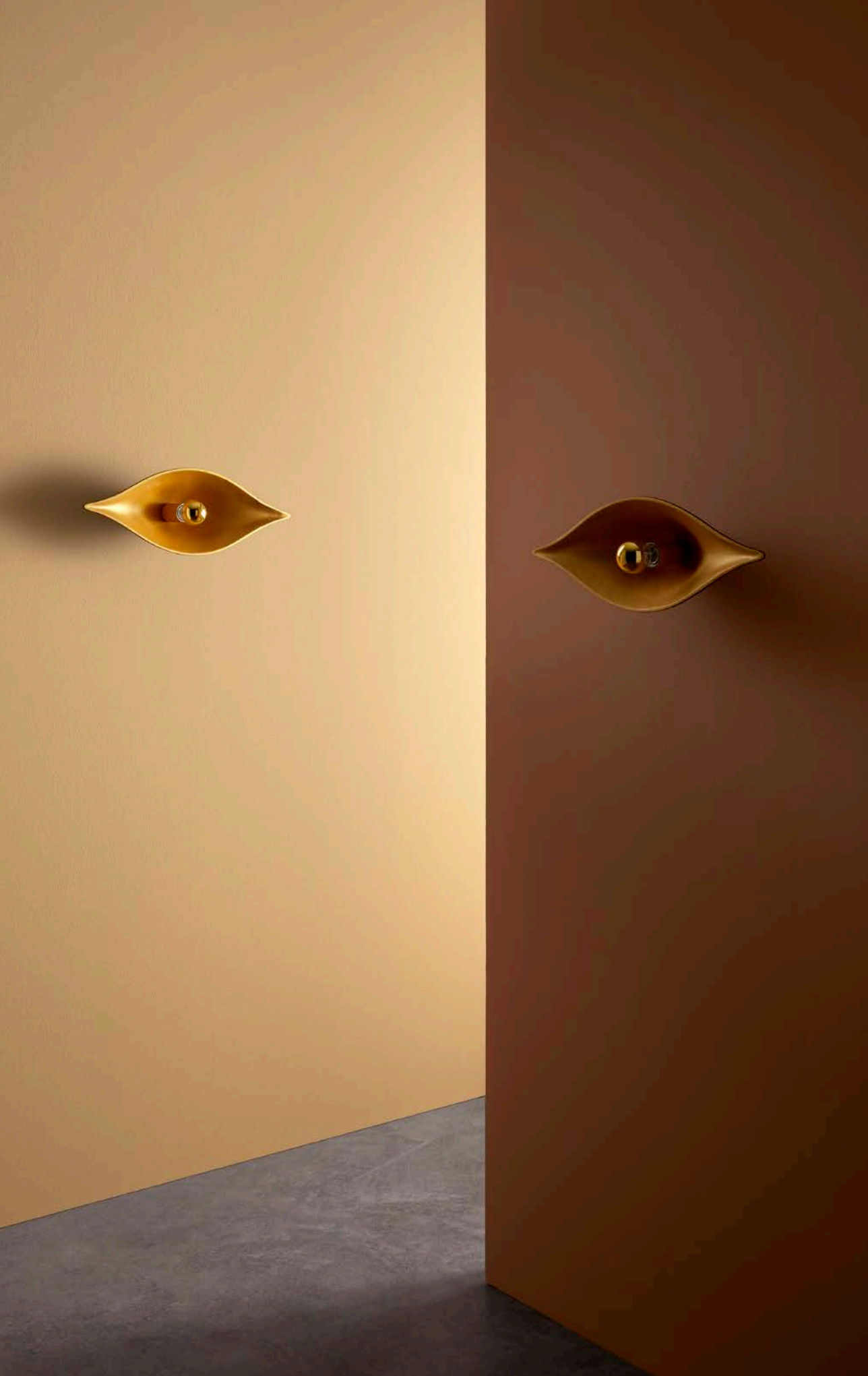







READ

DESIGNED BY AC STUDIO, 2009 · A1106

ES

ACABADOS
Metal: Cromo
Textil: Blanco

MATERIALES
Acero / Pantalla Textil

ESPECIFICACIONES (UE)
E27 Max. 60W (No incluida)
220-240 V, 50/60 Hz
IP20, Clase I
Led 3W - 3000K - 270 lm (Incluida)
12 V, 50/60 Hz, IP20, Clase I
IP20     

CLASIFICACIÓN ENERGÉTICA
A ++





PANTALLA INCLUIDA

BOMBILLA E27 RECOMENDADA
B211 (7, 9, 11W)

EN

FINISHES
Metal: Chrome
Fabric: White

MATERIALS
Steel / Fabric

SPECIFICATIONS (UE)
E27 Max. 60W (Not included)
220-240 V, 50/60 Hz
IP20, Class I
Led 3W - 3000K - 270 lm (Included)
12 V, 50/60 Hz, IP20, Class I
IP20     

ENERGY LABEL
A ++

SHADE INCLUDED

RECOMMENDED E27 BULB
B211 (7, 9, 11W)

TEC

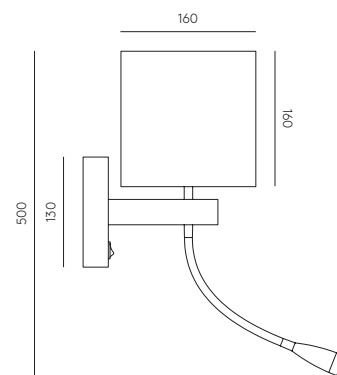

CROPI





DESIGNED BY PEPE FORNAS, 2017 · A1100

ES

ACABADOS
Metal: Oro Envejecido
Negro

MATERIALES
Acero

MEDIDAS
Diámetro 250 mm
Diámetro 560 mm

ESPECIFICACIONES (UE)
E27 60 W Max (No Incluida)
220-240 V, 50/60 Hz,
IP20, Clase I
IP20     

CLASIFICACIÓN ENERGÉTICA
A ++

BOMBILLA IMAGEN
B035 ORO

EN

FINISHES
Metal: Aged Gold
Black

MATERIALS
Steel

MEASUREMENTS
Diameter 250 mm
Diameter 560 mm

SPECIFICATIONS (UE)
E27 60 W Max (Not Included)
220-240 V, 50/60 Hz,
IP20, Class I
IP20     

ENERGY LABEL
A ++

IMAGE BULB
B035 GOLD

TEC

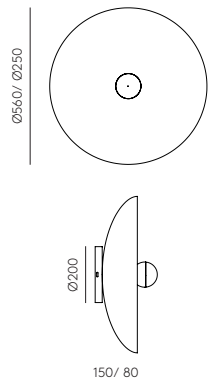



MINI LAITO

DESIGNED BY PEPE FORNAS, 2020 · A1098

ES

ACABADOS
Metal:
Negro

MATERIALES
Acero

ESPECIFICACIONES (UE)
E27 Max. 60W
(No incluida)
220-240 V, 50/60 Hz
IP20, Clase I



CLASIFICACIÓN ENERGÉTICA
A ++

BOMBILLA E27 RECOMENDADA
B211 (7, 9, 11W)

EN

FINISHES
Metal:
Black

MATERIALS
Steel

SPECIFICATIONS (UE)
E27 Max. 60W
(Not included)
220-240 V, 50/60 Hz
IP20, Class I



ENERGY LABEL
A ++

RECOMMENDED BULB
B211 (7, 9, 11W)

TEC

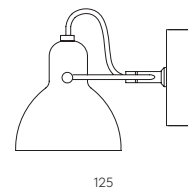
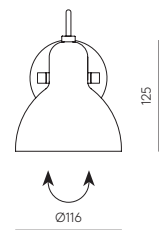



KASSY

DESIGNED BY FORNASEVI, 2018 · A1097

ES

ACABADOS

Metal:
Oro Brillo
Cromo
Blanco
Negro

MATERIALES

Acero / Cerámica

ESPECIFICACIONES (UE)

E27 Max. 60W (No incluida)
220-240 V, 50/60 Hz, IP20, Clase I

IP20

CLASIFICACIÓN ENERGÉTICA

A ++

DIMENSIONES DISCO CERÁMICO

200 - 300 mm

BOMBILLA IMAGEN

B038/ORO

EN

FINISHES

Metal:
Shinny Gold
Chrome
White
Black

MATERIALS

Steel / Ceramic

SPECIFICATIONS (UE)

E27 Max. 60W (Not included)
220-240 V, 50/60 Hz, IP20, Class I

IP20

ENERGY LABEL

A ++

DIMENSIONS OF CERAMIC DISC

200 - 300 mm

BULB IMAGE

B038/ORO

TEC

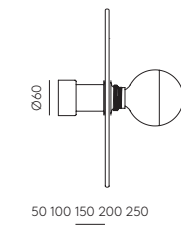
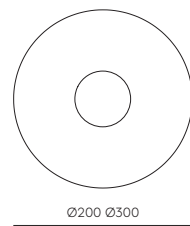

ALBA

DESIGNED BY JF SEVILLA, 2018 · A1096

ES

ACABADOS

Metal:
Oro Brillo
Cromo
Blanco
Negro

MATERIALES

Acero / Alabastro

ESPECIFICACIONES (UE)

E27 Max. 60W (No incluida)
220-240 V, 50/60 Hz, IP20, Clase I

IP20

CLASIFICACIÓN ENERGÉTICA

A ++

DIMENSIONES DISCO ALABASTRO

250 - 350 mm

BOMBILLA IMAGEN

B038/ORO

EN

FINISHES

Metal:
Shinny Gold
Chrome
White
Black

MATERIALS

Steel / Alabaster

SPECIFICATIONS (UE)

E27 Max. 60W (Not included)
220-240 V, 50/60 Hz, IP20, Class I

IP20

ENERGY LABEL

A ++

DIMENSIONS OF ALABASTER DISC

250 - 350 mm

BULB IMAGE

B038/ORO

TEC

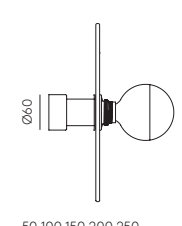
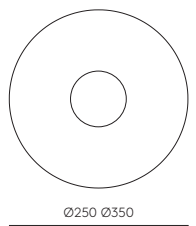



VASTER

DESIGNED PEPE FORNAS, 2017 · A1092

ES

ACABADOS
Metal:
Cromo

MATERIALES
Acero / Alabastro

ESPECIFICACIONES (UE)
Bombilla G9 5W 3000K (Incluida)
220-240 V, 50/60 Hz
IP20, Clase I

IP20    

CLASIFICACIÓN ENERGÉTICA
A ++

BOMBILLA RECOMENDADA
B005

EN

FINISHES
Metal:
Chrome

MATERIALS
Steel / Alabaster

SPECIFICATIONS (UE)
Bulb G9 5W 3000K (Included)
220-240 V, 50/60 Hz
IP20, Class I

IP20    

ENERGY LABEL
A ++

RECOMMENDED BULB
B005

TEC

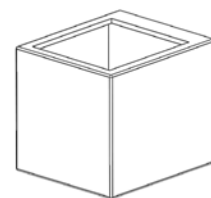
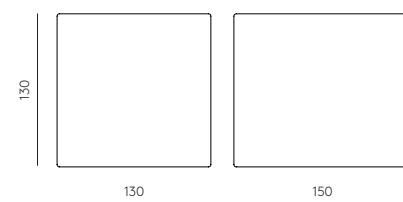

LINE

DESIGNED BY JF SEVILLA, 2019 · A1089

ES

ACABADOS
Metal:
Oro Brillo
Oro Mate
Cromo
Blanco
Negro

MATERIALES
Acero

ESPECIFICACIONES (UE)
E27 Max. 60W (Bombilla no incluida)
220-240 V, 50/60 Hz
IP20, Clase I

IP20    

CLASIFICACIÓN ENERGÉTICA
A ++

BOMBILLA RECOMENDADA
B038 / ORO

EN

FINISHES
Metal:
Shinny Gold
Matt Gold
Chrome
White
Black

MATERIALS
Steel

SPECIFICATIONS (UE)
E27 Max. 60W (Bulb not included)
220-240 V, 50/60 Hz
IP20, Class I

IP20    

ENERGY LABEL
A ++

RECOMMENDED BULB
B038 / GOLD

TEC

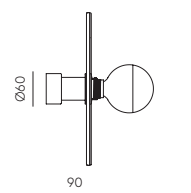



MINIROSS

DESIGNED BY JF SEVILLA, 2015 · A1063

ES





ACABADOS

Metal:
Oro Brillo
Oro Mate
Cromo
Negro Mate

MATERIALES

Acero

ESPECIFICACIONES (UE)

3 x Bombilla G9 Led (Incluida)
3W - 2700K
220-240 V, 50/60 Hz
IP20, Clase I
IP20     

CLASIFICACIÓN ENERGÉTICA

A ++

BOMBILLA RECOMENDADA

B005

EN

FINISHES

Metal:
Shinny Gold
Matt Gold
Chrome
Matt Black

MATERIALS

Steel

SPECIFICATIONS (UE)

3 x G9 LED Bulb (Included)
3W - 2700K
220-240 V, 50/60 Hz
IP20, Class I
IP20     

ENERGY LABEL

A ++

RECOMMENDED BULB

B005

TEC

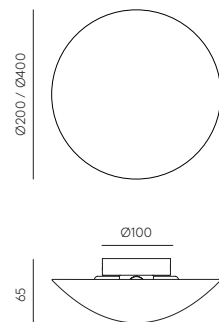

HABAN

DESIGNED BY JF SEVILLA, 2019 · A1053 + 1088

ES

ACABADOS





Soporte:
Negro
Oro
Cromo

Abanicos:
Consultar paleta
de colores en
pág. 372

MATERIALES

Acero

ESPECIFICACIONES (UE)

E27 Max. 60W (Bombilla no incluida)
220-240 V, 50/60 Hz
IP20, Clase I
IP20     

CLASIFICACIÓN ENERGÉTICA

A ++

BOMBILLA IMAGEN

B038/ORO (espejada)
B033/COB (opal)

EN

FINISHES



Support:
Black
Gold
Chrome

Fans:
Color palette
on page. 372

MATERIALS

Steel

SPECIFICATIONS (UE)

E27 Max. 60W (Bulb not included)
220-240 V, 50/60 Hz
IP20, Class I
IP20     

ENERGY LABEL

A ++

BULB IMAGE

B038/ORO (reflecting)
B033/COB (opal)

TEC

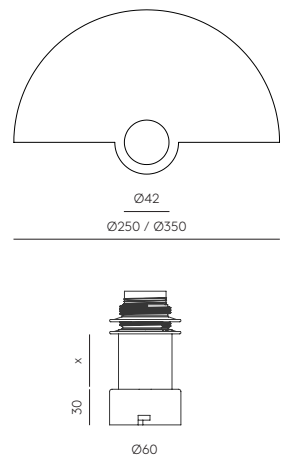



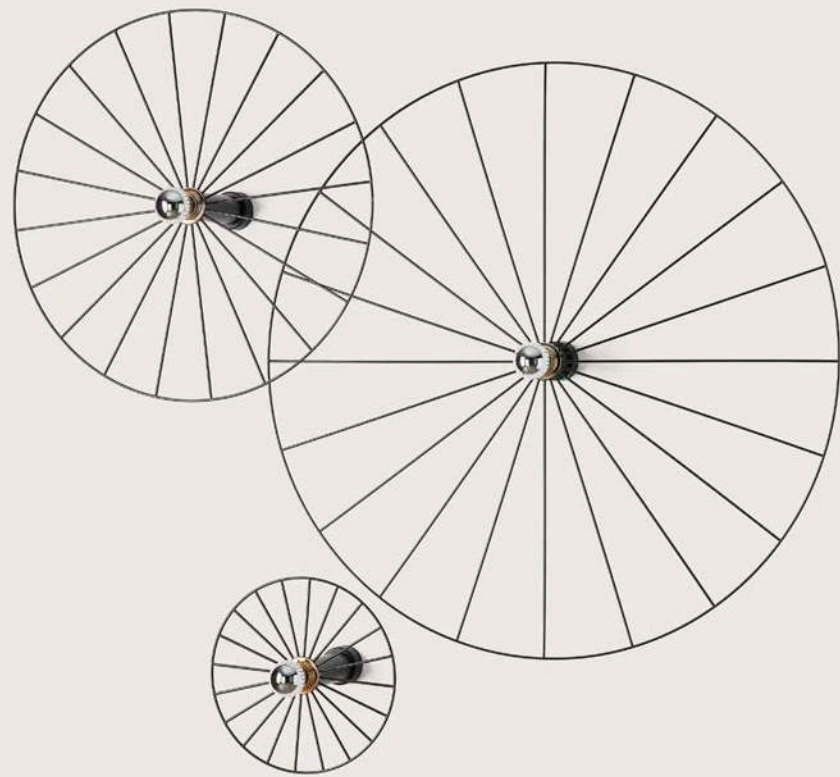

WHEEL

DESIGNED FORNASEVI, 2015 · A1053 + R1052

ES

ACABADOS

Soporte:
Oro Brillo / Cromo /
Blanco Mate / Negro

Rueda:
Oro Brillo /
Cromo /
Blanco Mate /
Negro

MATERIALES
Acero

ESPECIFICACIONES (UE)

E27 Max. 60W (No incluida)
220-240 V, 50/60 Hz, IP20, Clase I

IP20

CLASIFICACIÓN ENERGÉTICA

A ++

MODIFICACIONES POSIBLES

Posibilidad colgante con C1010

BOMBILLA RECOMENDADA

Ø300 - B038 (Oro/Cromo)
Ø600 - B035 (Oro/Cromo)
Ø900 - B035 (Oro/Cromo)

EN

FINISHES

Support:
Shinny Gold / Chrome /
Matt White / Black

Wheel:
Shinny Gold /
Chrome /
Matt White /
Black

MATERIALS
Steel

SPECIFICATIONS (UE)

E27 Max. 60W (Not included)
220-240 V, 50/60 Hz, IP20, Class I

IP20

ENERGY LABEL

A ++

POSSIBLE MODIFICATIONS

Pendant possibility with C1010

RECOMMENDED BULB

Ø300 - B038 (Gold/Chrome)
Ø600 - B035 (Gold/Chrome)
Ø900 - B035 (Gold/Chrome)

TEC

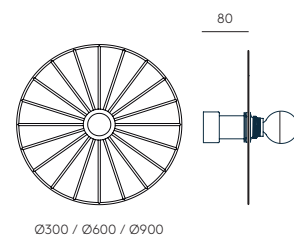

HEDULA

DESIGNED FORNASEVI, 2020 · A1053 + 1161

ES

ACABADOS
Soporte:
Negro Mate

Rueda:
Negro Mate

MATERIALES
Acero

ESPECIFICACIONES (UE)

E27 Max. 60W (No incluida)
220-240 V, 50/60 Hz,
IP20, Clase I

IP20

CLASIFICACIÓN ENERGÉTICA

A ++

MODIFICACIONES POSIBLES

Posibilidad colgante con C1010

BOMBILLA RECOMENDADA

Ø300 - B038 (Oro/Cromo)
Ø600 - B035 (Oro/Cromo)
Ø900 - B035 (Oro/Cromo)

EN

FINISHES

Support:
Matt Black

Wheel:
Matt Black

MATERIALS
Steel

SPECIFICATIONS (UE)

E27 Max. 60W (Not included)
220-240 V, 50/60 Hz,
IP20, Class I

IP20

ENERGY LABEL

A ++

POSSIBLE MODIFICATIONS

Pendant possibility with C1010

RECOMMENDED BULB

Ø300 - B038 (Gold/Chrome)
Ø600 - B035 (Gold/Chrome)
Ø900 - B035 (Gold/Chrome)

TEC

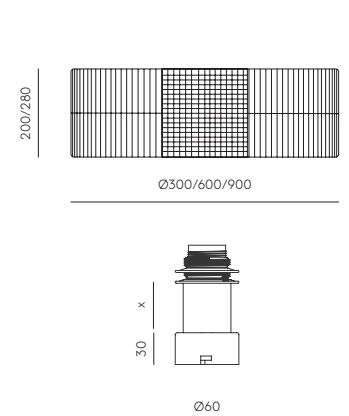

Accessories



1038

MATERIAL
METAL

FINISH
GOLD
CHROME
BLACK
WHITE

SIZES
Ø150
Ø250
Ø350

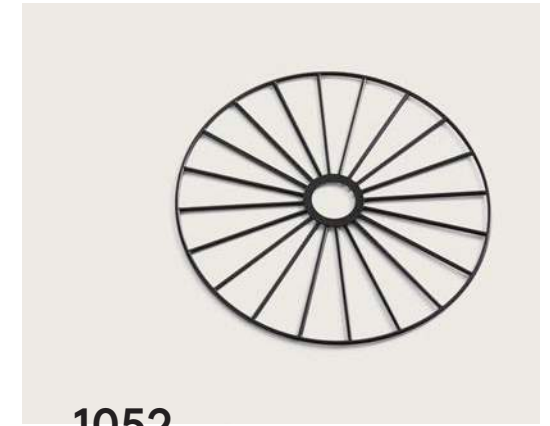

1052

MATERIAL
METAL

FINISH
GOLD
CHROME
BLACK
WHITE

SIZES
Ø300
Ø600
Ø900



1088

MATERIAL
METAL

FINISH
WHITE
BLACK
COLOR,
CONSULT US

SIZES
Ø250
Ø350



1089

MATERIAL
METAL

FINISH
GOLD
CHROME
BLACK
WHITE

SIZE
Ø250



1096

MATERIAL
ALABASTER

FINISH
NATURAL

SIZES
Ø250
Ø350



1097

MATERIAL
CERAMIC

FINISH
CERAMIC

SIZES
Ø200
Ø300



1132

MATERIAL
RESIN

FINISH
WHITE
BLACK
COLOR,
CONSULT US

SIZE
Ø500



1142

MATERIAL
DRIED GRASS

SIZE
40x30cm



1141

MATERIAL
DRIED GRASS

SIZE
Ø300
Ø500



1163

MATERIAL
METAL WIRE

FINISH
GOLD
CHROME
MATT BLACK
MATT WHITE

SIZES
Ø300
Ø520



1215

DESCRIPCIÓN
Soporte para fijación de colgantes a pared

SIZE
250mm

DESCRIPTION
Support for wall hanging fixing



1223

MATERIAL
GLASS

FINISH
PINK
TURQUOISE
DARK BLUE
AMBER
BROWN

SIZE
Ø250



C1010

MATERIAL
METAL

FINISH
BLACK

SIZE
3M CABLE

BULB
E27



C1010

MATERIAL
METAL

FINISH
GOLD

SIZE
3M CABLE

BULB
E27



C1011

MATERIAL
METAL

FINISH
BRONZE

SIZE
3M CABLE

BULB
E27



C1012

MATERIAL
METAL

FINISH
BLACK

SIZE
3M CABLE

BULB
E27



A1053

ES	EN	TEC
MATERIAL Metal	MATERIAL Metal	
ACABADOS Oro Brillo Cromo Blanco Negro	FINISH Shinny Gold Chrome White Black	
DIMENSIONES (X) 5 cm 10 cm 15 cm 20 cm 25 cm	DIMENSIONES (X) 5 cm 10 cm 15 cm 20 cm 25 cm	
BOMBILLA E27	BULB E27	

Bulbs



B223

E27
4W
420 lm
2700K



B211

E27
7W / 750 lm / 3000K
9W / 810 lm / 2700K
11W / 990 lm / 3000K
Regulable / Dimmable

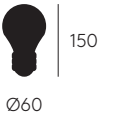

B161

GU10
5W
420 lm
3000K / 5000K



B116-2

E14
5W
420 lm
3000K / 5000K



B056

E27
3W
350lm
2700K

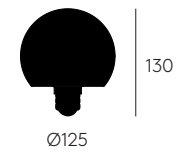

B055

E27
3W
350lm
2700K

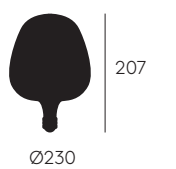



B054

E27
3W
270 lm
2700K

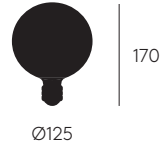

B053

E27
3W
270 lm
2700K

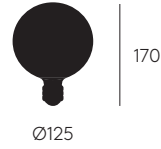

B052

G95 E27
7W
806 lm
2700K

OPAL



B046

E27
3W
270lm
2700K



B051

E27
3,8W
2700K
Control WI-FI



B050

E27
2,5W
90 lm / 100 lm / 110 lm
2000K / 3000K / 4000K
Regulable / Dimmable



B043

E27
4W
130 lm
Led 1800K

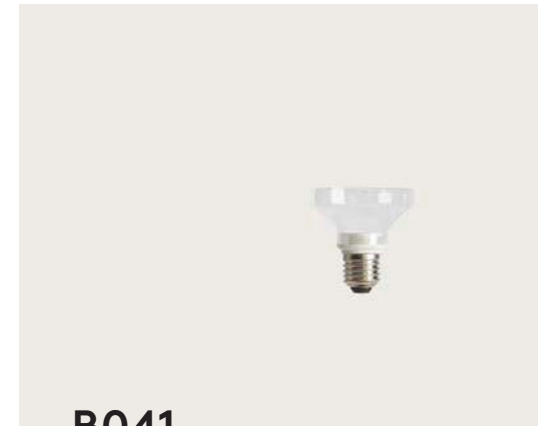

B041

E27
COB 3W
350 lm
2700K

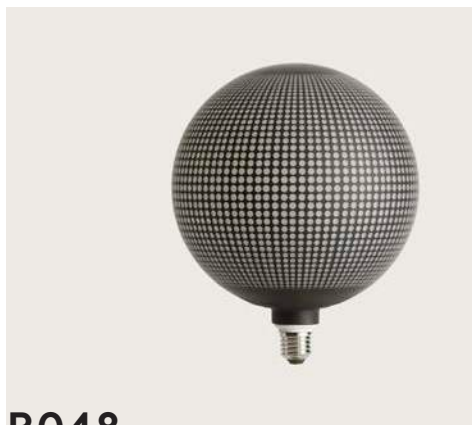

B048

G200 E27
3W
2700K
Puntos Negros

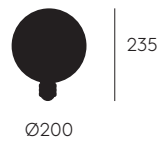

B047

G125 E27
3W
2700K
Puntos Negros



B039

E27
6W
806 lm
2700K

GOLD
CHROME

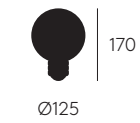

B038

E27
4W
550 lm
2700K
Regulable / Dimmable

GOLD
CHROME

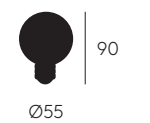



B037

E27
COB 3W
350 lm
2700K



B035

E27
6W Led
806 lm
2700K

GOLD
CHROME

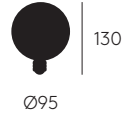

B023

E27
4W Led
300 lm
2200K
Regulable / Dimmable



B020

E27
4W Led
300 lm
2200K
Regulable / Dimmable

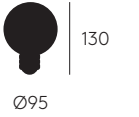

B034/ B033

E27
COB 3W
350 lm
2700K

OPAL
CLEAR



B030

E27
4W
450 lm
2700K

GOLD
CHROME



B019

E27
4W Led
300 lm
2200K



B015

E27
COB 3W
350 lm
2700K



B028

E27
COB 3W
350 lm
2700K

Ø125



B027

E27
COB 3W
350 lm
2700K

Ø125

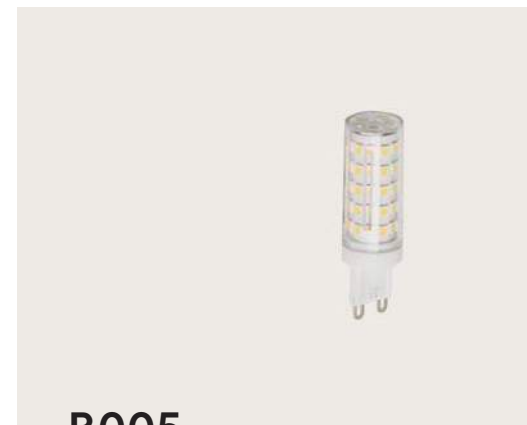

B005

E27 - G9 - 3000k
3W - 270lm
5W - 450 lm (opción regulable /
Dimmer option)
8W - 720 lm (regulable DALI Consultar /
Dimmable DALI Consult)

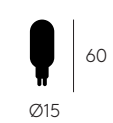

B004

E27
6W Led
450 lm
2700K

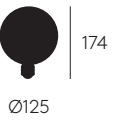

Paleta de Color Cerámica y Vidrio Color Palette Ceramics & Glass

Los colores de la paleta son aproximados.
Consultar los códigos en la carta RAL o NCS.

The colors in the palette are approximate.
Consult the RAL or NCS references.

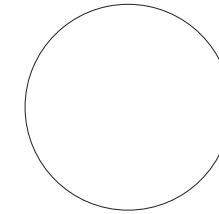

BLANCO /
WHITE

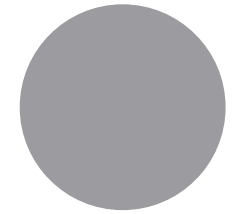

GRIS CENIZA /
ASH GREY
NCS S4000N

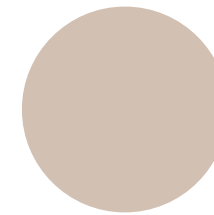

NUDE /
NUD
NCS S2010Y50R

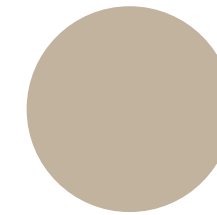

SILHOUETTE
NCS S2809Y01R

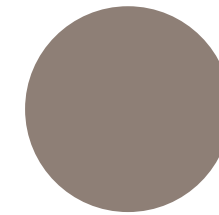

MARRÓN VINTAGE /
VINTAGE BROWN
NCS S5505Y46R

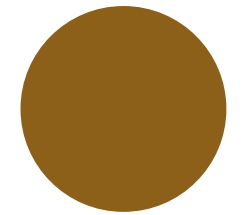

MIEL /
HONEY
NCS S5040Y10R

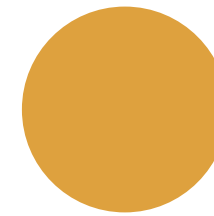

MUSTARD /
MOSTAZA
NCS S2050Y10R

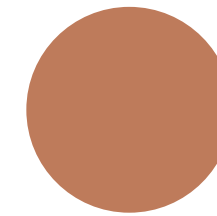

NATURAL CLAY
NCS S3932Y40R

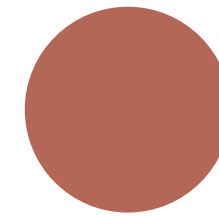

TERRACOTA /
TERRACOTTA
NCS S4030Y70R

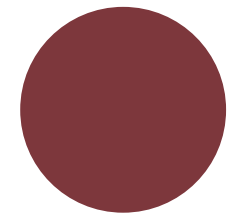

GRANATE /
MAROON
NCS S5040R10B

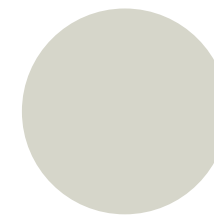

VERDE MOLE /
MOLE GREEN
NCS S2005G70Y

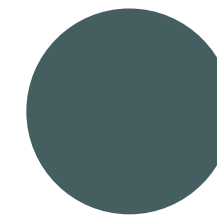

VERDE HUNT /
HUNT GREEN
NCS S6530B50G

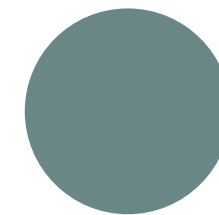

VERDE DUNKEL /
DUNKEL GREEN
NCS S5020B70G

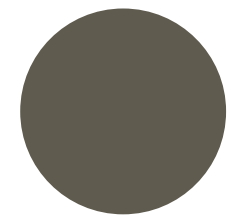

VERDE HOJA /
GREEN LEAF
NCS S7005G80Y

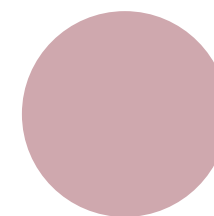

ROSA PALO /
PALE PINK
NCS S2010R10B

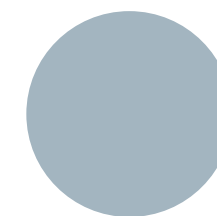

AZUL MÉXICO /
MEXICO BLUE
NCS S3010B10G

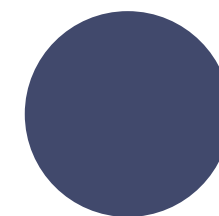

AZUL PETROLEO /
PETROL BLUE
NCS S6030R90B

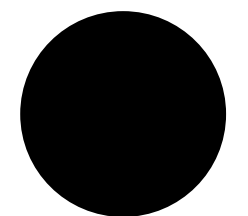

NEGRO /
BLACK

Colores de Cristales Color Glass



ÁMBAR / AMBER



ROSA / PINK

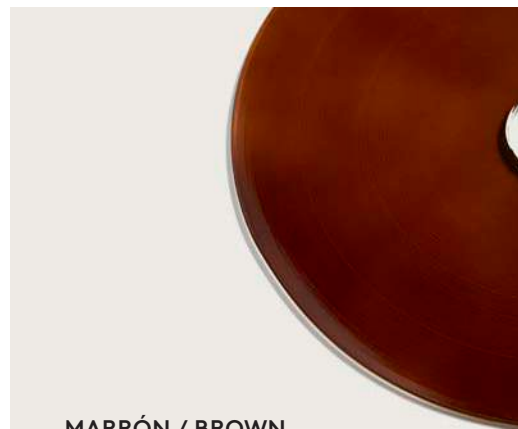

MARRÓN / BROWN



TURQUESA / TURQUOISE



AZUL OSCURO / DARK BLUE

Paleta de Color Mármol Marble Color Palette

Los colores de la paleta son aproximados.
Consultar los códigos en la carta RAL o NCS.

The colors in the palette are approximate.
Consult the RAL or NCS references.

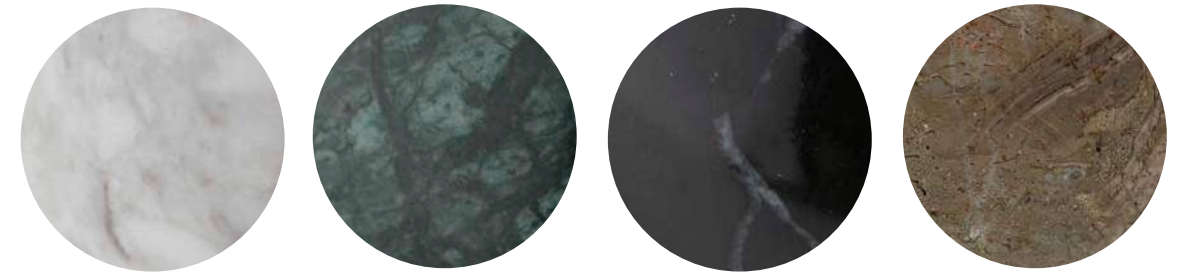

Acabados Pastel Pastel Finishes

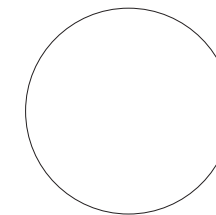

BLANCO/
WHITE

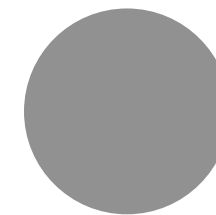

GRIS CENIZA/
ASH GREY
NCS S4000N

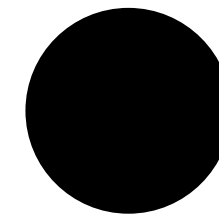

NEGRO/
BLACK

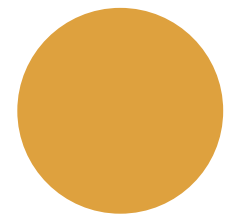

MOSTAZA /
MUSTARD
NCS 2050Y10R

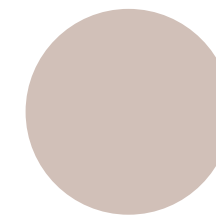

TOPO /
TAUPE
NCS 2005Y60R

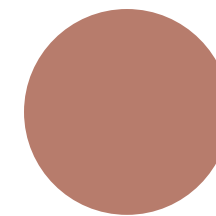

MAQUILLAJE /
MAKE UP
NCS 3020Y70R

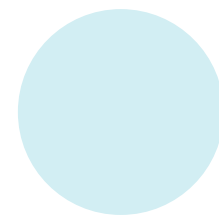

VERDE SHELL /
SHELL GREEN
NCS 0907B20G

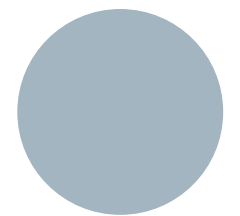

AZUL MÉXICO /
MEXICO BLUE
NCS 3010B10G

Condiciones Generales

1. PRECIOS

- 1.1. Los indicados en esta tarifa, son sin IVA ni recargo de equivalencia que proceda.
- 1.2. Los precios de las lámparas no incluyen bombillas o pantallas, salvo que este indicado lo contrario.
- 1.3. Esta tarifa de precios anula todas las anteriores.

2. PEDIDOS

- 2.1. Es imprescindible enviar los pedidos o modificaciones por correo electrónico, no se aceptarán pedidos por teléfono o modificaciones.

3. CONDICIONES DE PAGO

- 3.1. La forma de pago general es pago anticipado. En el caso de cambio de pago a giro o similar, el cliente deberá remitir con su firma y sello el formulario de domiciliación SEPA.
- 3.2. En las cuentas de los clientes con riesgo comercial aprobado, las condiciones particulares de pago, se acordarán individualmente con el responsable comercial de cada zona, y serán aprobadas por el departamento financiero.
 - 3.2.1 En ningún caso excederán los siguientes límites:
Vencimiento 45 días con giro bancario domiciliado se aceptan días de pago fijos a propuesta del cliente. Para aquellos clientes que no puedan aceptar cargos por GIRO bancario, la forma de pago máxima será transferencia o pagaré a 30 días. Se aceptan días de pagos fijos a propuesta del cliente.
- 3.3. Los pedidos de proyectos que por su volumen deban ser fabricados, se deberá abonar un 30% o 50% del valor del pedido, como confirmación e inicio de producción.
- 3.4. El cliente no está autorizado a deducir, de los vencimientos, ningún importe en concepto de reclamación. A menos que les hayamos autorizado a ello por escrito.
- 3.5. En el caso de impagos, AROMAS se reserva el derecho de no aceptar o enviar pedidos hasta desbloquear la cuenta nuevamente.

4. CONDICIONES DE TRANSPORTE

- 4.1. Los pedidos superiores a 350€ netos se enviarán a portes pagados a territorio nacional. Para pedidos de importes inferiores, los portes se cargarán en factura con un mínimo de 9€ o el 7% del valor de la mercancía. En el caso de Portugal, los portes pagados son por pedidos superiores a 600€ netos. Para pedidos de importes inferiores, los portes son de 30€.
- 4.2. Los portes de los pedidos solicitados por transporte urgente, serán a cargo del cliente, previa aceptación del mismo, sea cual sea su importe.

5. INCIDENCIAS DEL TRANSPORTE

- 5.1. Si se produce alguna anomalía, daños visibles, embalaje dañado o se intuyen daños ocultos, deberá hacérselos constar por escrito en el albarán del transporte, en el momento de la recepción de la mercancía. Además, se debe notificar a Aromas del Campo, en las 24h posteriores a la entrega, vía correo electrónico, incluyendo copia del albarán y fotos.

6. REPARACIONES

- 6.1. El presupuesto de reparación se realizará una vez la lámpara está en fábrica.
- 6.2. Los portes de las mercancías que se desea reparar serán a cargo del cliente.
- 6.3. Las lámparas que hace más de un año que están descatalogadas, se puede solicitar el envío con cargo de recambio de las piezas en el caso de que estén disponibles.

7. DEVOLUCIONES

- 7.1. Solo se admiten devoluciones causadas por incidencia de producto y que haya sido autorizado previamente por Aromas del Campo.
- 7.2. Las devoluciones deben enviarse con su embalaje original, de lo contrario nuestro almacén rechazará la entrada de la mercancía.
- 7.3. Una vez verificado el producto por nuestro dpto. de calidad, en el caso de no conformidad, se cargará al cliente los gastos de reenvío y los recargos que se estimen oportunos. Pudiendo aplicar hasta un 15% de penalización en concepto de reembalaje.

8. VENTA ONLINE

- 8.1. Para poder ser distribuidor autorizado a vender y publicar luminarias de AROMAS DEL CAMPO a través del sitio web, es imprescindible haber firmado el acuerdo de venta Online.
- 8.2. Cualquier producto de AROMAS DEL CAMPO que se desee poner en soporte WEB debe cumplir unas condiciones de inserción.

9. CONDICIONES GENERALES

- 9.1. AROMAS DEL CAMPO se reserva el derecho a efectuar cualquier modificación y anulación de los productos del catálogo y la tarifa vigente sin preaviso alguno.
- 9.2. El cliente declara conocer y aceptar las condiciones de venta aquí descritas.

General Conditions

1. PRICES

- 1.1. The given prices are the suggested retail prices without VAT.
- 1.2. The pricing do not include bulbs or shades except when mentioned.
- 1.3. This Price list nullify any other Price list.

2. ORDERS

- 2.1. All orders must be sent via email with reference codes, names, colors and if shades and bulbs are needed.

3. PAYMENT TERMS

- 3.1. All orders must be paid in advance by wire transfer with proforma number in description..
- 3.2. In case of orders that require customized products or for projects orders, the company will require total payment or 50% advanced payment.
- 3.3. Payment delays for holidays or festivities will not be accepted.
- 3.4. The delivery date is determined by the circumstances from the date in which the proforma is paid.
- 3.5. The client is not authorized to claim any incident if it is not in writing.
- 3.6. The company reserves right to deny orders if the client does not comply with payment commitments.

4. TRANSPORTATION

- 4.1. Transportation costs are calculated according to order and destination.
- 4.2. If client requires urgent shipment, additional costs will be applied.

5. CLAIMS

- 5.1. Any visible damage in packaging must be notified to shipping company upon receipt.
- 5.2. Claims will be accepted 5 working days after receiving order.
- 5.3. Claims must be sent via email to account manager with photos and description. If the above points are not met, the claim can be disqualified.
- 5.4. Claims will be accepted 5 working days after receiving order.
- 5.5. Damage claims are not included except if proved to be manufacturing flaw by AROMAS DEL CAMPO.

6. REPAIRS

- 6.1. If a third party wishes to repair a product before being returned to factory, it must be authorized by AROMAS DEL CAMPO.
- 6.2. The product must be packed correctly and in the original box.
- 6.3. Once the product is received in factory, an approximate price to repair will be issued.
- 6.4. Transportation costs will be covered by client.
- 6.5. In case the lamp has been discontinued, it can be repaired if the company has spare parts.
- 6.6. All repairs will be charged.

7. RETURNS

- 7.1. All returns must have approval by company, including claim cases.
- 7.2. For defective products, shipping company authorized by AROMAS will pick up correctly packed box.
- 7.3. We reserve right to charge additional repair costs if the returned package is damaged.
- 7.3. After product examination concludes that complaint was not justified, the company reserves right to charge extras.

8. WEB

- 8.1. In order to sell or publish any AROMAS DEL CAMPO product on the internet, an agreement must be signed.
- 8.2. The display of photographs of products or similar to AROMAS DEL CAMPO in websites must have specified authorization by the company.

9. GENERAL CONDITIONS

- 9.1. AROMAS DEL CAMPO reserves right to modify, without notice, prices in current catalogue and discontinue products.
- 9.2. Printing errors reserved.
- 9.3. Delivery dates are not complaining, AROMAS DEL CAMPO will attempt to fulfill them, however, cannot be held accountable under any case.
- 9.4. Discount rates can be modified at any moment.
- 9.5. Services offered by any company related to AROMAS DEL CAMPO distribution of products; like replacement of lamps, components, shipping of tester products, are covered by AROMAS DEL CAMPO.
- 9.6. All products are property of AROMAS DEL CAMPO until complete claim settlement.
- 9.7. Client accepts the conditions mentioned in this document.
- 9.8. AROMAS DEL CAMPO reserves right to declare a client account null if commercial agreement terms are not met.

Iconos / Icons



Tipo I
Class I



Tipo II
Class II



Reciclable
Recyclable



Aparato electrónico no reciclable
Non-recyclable Electronic device



Certificación Europea
European Certification



Ajustable
Adjustable



Ajustable izquierda - derecha
Adjustable left - right



Ajustable arriba - abajo
Adjustable up - down



Bombilla incluida
Bulb included



Bombilla no incluida
Bulb not included



Bombilla no reciclable
Non-recyclable bulb



Clase energética
Energy class



Regulador de intensidad
Dimmer



Se enciende al tocar
Touch active

IP20

Protección frente a sólidos de tamaño superior a 12mm y ninguna protección de líquidos
Protection against solids larger than 12mm and no protection from liquids

Información general

Las descripciones y medidas de los productos del presente catálogo son orientativas, pudiendo por tanto ser modificadas, a fin de mejorar las características técnicas o de diseño. La empresa se reserva el derecho de anular o modificar cualquier modelo sin previo aviso. Todos los modelos cumplen las normas exigidas por la CE para iluminación de uso doméstico y sus características vienen determinadas por las clase 1 y la clase 2. Los acabados y las especificaciones técnicas corresponden a los productos que se suministran en Europa, pudiendo estos variar en otros mercados. Para una buena conservación de las lámparas, no usar bombillas de potencia superior a las recomendadas y limpiar solamente con un paño seco. No usar limpiametales ya que dañan los barnices protectores que garantizan la duración del acabado.

General Information

The descriptions and dimensions of the items in this catalogue are indicative and may be modified for the purpose of technical or design improvements. We reserve the right to cancel or change all models without prior notice. All items meet the CE Class 1 and class 2 safety regulations for home lighting appliances. The finishings and technical specifications listed here are for the european market and may vary elsewhere. Do not use stronger bulbs that recommended, and always clean lamps with a soft dry cloth. Metal polish will damage the protective finishings.

PROJECT DIRECTION

ángelsegura<

CONCEPT & ART DIRECTION

PerezOchando

PHOTOGRAPHY

ángelsegura<

PRINTED BY

Libecrom

© AROMAS DEL CAMPO SL 2021